

ELBA

WASHING MACHINE

MODEL: EWF-N1087D(GR)

Owner's Manual

Please read this manual carefully before operating your set.

Retain it for future reference.

Record model number and serial number of the set.

See the label attached on the set and quote this information to your dealer when you require service.

For The Warranty Terms & Conditions, Please Refer To Warranty Certificate

We recommend that you read the instructions in this owner's manual carefully before using it for the best performance and to extend the lifespan of your appliance, as it will provide you with all the instructions you require to ensure its safe installation, use and maintenance.

1. SAFETY PRECAUTIONS

- To ensure your safety, all electric appliances should only be installed or serviced by qualified technician. If the supply cord is damaged, it must be replaced by the authorized service center or similarly qualified technician in order to avoid hazard.
- Do not place supply cord on the edge of table and counter, or near any heating appliance.
- In order to avoid electric shock, do not immerse supply cord, plug or other parts into water.
- Do not place the appliance near electric stove, heated oven or other heat source.
- In order to avoid burning or risk of fire, combustibles or flammable material (curtains, cloth, wallpaper and others) should be kept away from the appliance.
- When the appliance is not being used, everything should be removed from the drum.
- Accessible parts may become hazardous during use, please keep away from children.
- Disconnect the appliance from the power supply before cleaning or maintenance.
- When the appliance is faulty, please contact the authorized service center. Do not attempt to repair by yourself.
- Never use metal scouring pads or sharp scrapers which will damage the appliance surface or interior wall, leading to scratches of the enamel.
- In order to avoid hazard or electric shock, never put laundry exceeding the capacity.
- Please make sure the power has been switched off when the appliance is not in used.
- Unplug from the socket when you are planning not to use the appliance for long time.

2. ATTENTIONS

- In order to avoid electric shock, please make sure the appliance has been shut off before carrying out the maintenance.
- Use only original accessories provided by ELBA or its authorized service center.
- Do not use wet parts of the body to touch the appliance.
- Do not pull the appliance by its supply cord.
- The appliance should not be exposed to rain or direct sunshine.
- Do not use or store flammable objects near to the appliance.
- Always pull out the plug and cut off the water supply after the operation.
- The appliance shall not be installed in bath room or wet rooms.
- Do not refill the water manually by hand while washing.
- After the washing cycle is completed, please wait for three minutes to open the door.

Distributors decline all liability for not following above instructions or some improper operations which caused personal injury and property loss.

3. INSTALLATION

3.1 ENVIRONMENT

Leave some space

Maintain at least 10cm between the washer and the wall

Place the washer on a sturdy flat surface

If the washer is placed on an uneven surface, noise or vibration will occur. (Max. tilt angle on the supporting surface: 2°)

Adjust the legs for even placement.

Never install the washer near water.

Do not place the washer in steamy rooms or where the washer is directly exposed to rain. Moisture may destroy the electrical insulation causing an electrical shock hazard.

Avoid direct sunlight or heater

As plastic and electrical components are affected by direct heat, never place the washer near furnaces, boilers, etc.

Do not place the washer under direct sunlight.

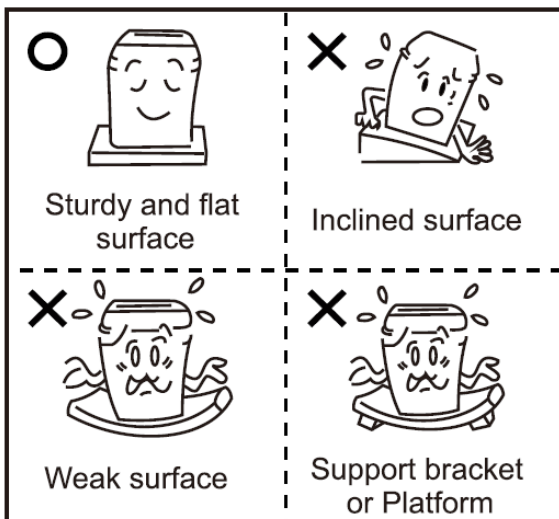

ASSEMBLING THE BOTTOM PLATE

1. Place the washing machine on the soft laying cloth, the front side of the machine is towards the upper.
2. Insert the bottom plate into the slots on the base under, and then tighten it with screw.

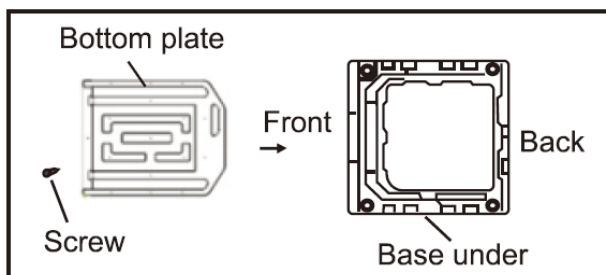

LEVELING THE WASHER

If the washer is not leveled with the ground, it makes the machine tremble more or be out of order. So, make sure that the washer is leveled properly.

SEE IF THE MACHINE IS PLACED LEVEL BY CHECK THE POSITION OF THE WASHING TUB

Open the lid of the machine, pour water into the tub up to the level just below the pulsator, and adjust the adjustable feet so that the pulsator is positioned at the center of the water as shown in the figure.

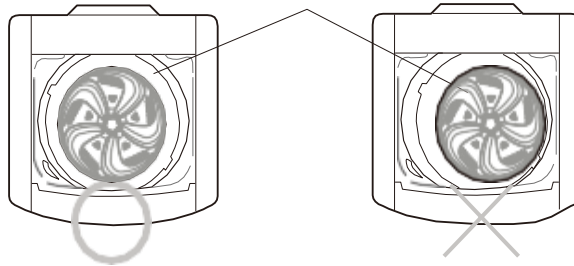

ADJUST THE INSTALLATION POSITION

- If the floor is uneven, adjust the adjustable feet of the washing machine to level position. Lift the adjustable feet up slightly and turn the feet to level position.
- The distance between the washing machine and wall: at least 10cm.
- Max. tilt angle on the supporting surface: 2°.

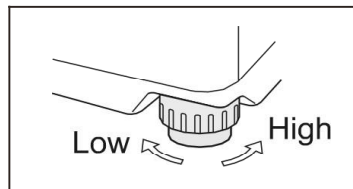

ATTENTION

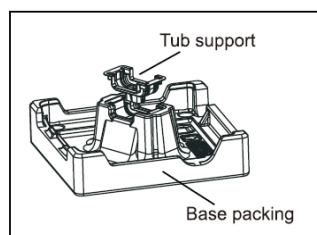

- When installing the machine, it is required to remove two of the packing parts, include base packing and tub support as shown in the figure. Otherwise, the washing machine will not run normally.
- During the installation of the washer or during the first use, there may be some water flow out from the drain hose, which is the residual water at the step of inspection by the manufacturer.
- After washing, be sure to pull out the power plug and close the water faucet. This is to avoid an electric shock, hazard fire or water leakage to take place.



3.2 BEFORE THE INSTALLATION

- Please check the products and make sure there is no damage on the appliance.
- The appliance door is level, and you can open and close the appliance door flexibly.
- Specification on the marking plate is in compliance with the regulations.
- If the appliance appears in an abnormal way, do not install and unplug the power supply before contacting the authorized service center.
- Do not attempt to repair or service the appliance by yourself. Repair or maintenance should only be carried out by a qualified technician or the authorized service center.
- This appliance must be installed only by qualified technician or the authorized service center. Manufacturer declines all responsibility for improper installation, which may harm persons and cause damage to the property.
- The AC power supply should be supplied with 220-240V, 50Hz with minimum 13A distribution circuit fuse or circuit breaker.

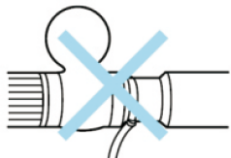
NEVER CONNECT THE GROUND WIRE TO SUCH A THING

<p>• Never connect it to a gas pipe because of danger of a explosion.</p>  <p>Gas Pipe</p>	<p>• Never connect it to a telephone wire or a lightning rod because of very dangerous at a thunderbolt.</p>  <p>Telephone Wire</p>
--	--

3.3 SUITABLE WATER FAUCET TYPES

Water faucet type, as shown in the below figure:

Type A: This type is suitable. It is a special faucet for washer using.

Type B: This type is suitable. It is required that the front end of the faucet shall be longer than 10mm. The exit end surface of the faucet must be flat and smooth. Otherwise it may leak water. Please file the end surface to avoid leakage.

Type C: This type faucet is not suitable, there may be leakage in the place shown in the figure.

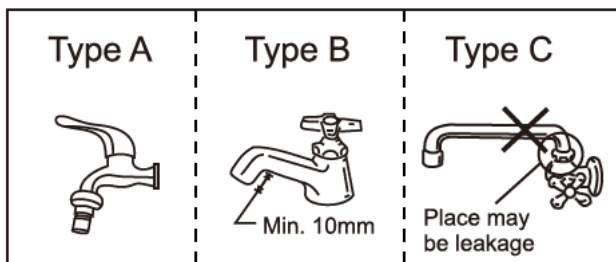

If the water faucet is not suitable, it is needed to replace a suitable water faucet before connecting the water inlet hose.

3.4 CONNECTION OF THE WATER SUPPLY HOSE

Connect the other end of the water supply hose to the inlet water valve at the back of the washer. Screw the hose clockwise tightly.

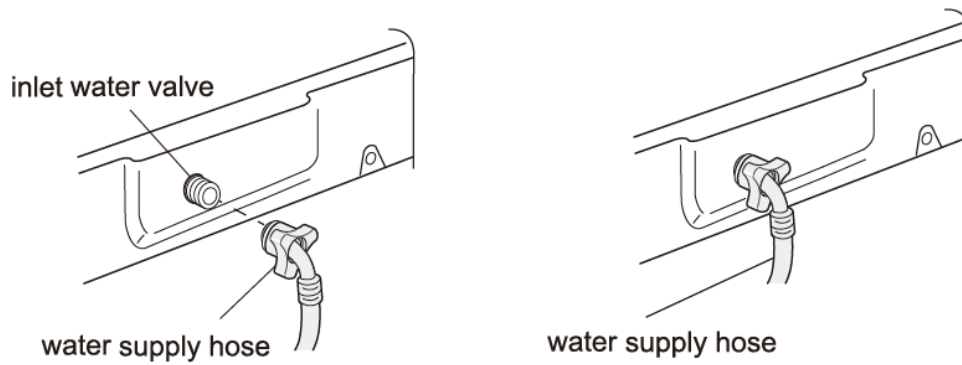

INSTALLATION TYPE 1

If the water tap is a screw type, assembly a water supply hose that fit to the tap as shown.

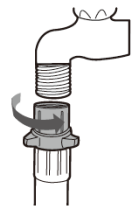
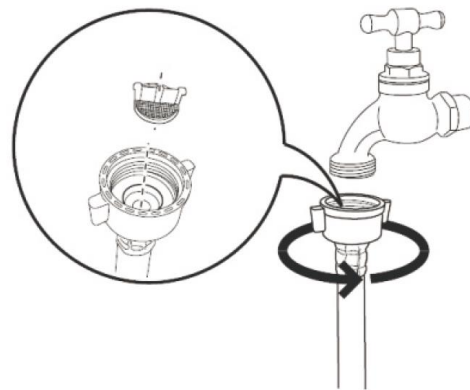

INSTALLTION TYPE 2

1. Remove the adaptor from the water supply hose.

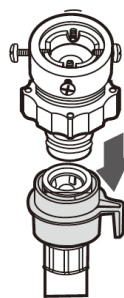

2. First, using a "+" type screw driver to loosen the four screws on the adaptor. Next, take the adaptor and turn part (b) clockwise to leave a gap about 5mm between them.

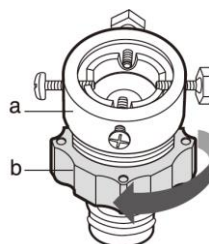

- Connect adaptor to the water tap by tightening the screws firmly. Then, turn part (b) anti-clockwise and put part(a) and part(b) together.

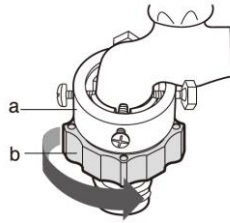

- Connect the water supply hose to the adaptor. Pull down the part (c) of the water supply hose. When the part (c) is released, the hose is automatically connected to the adaptor making a 'click' sound.

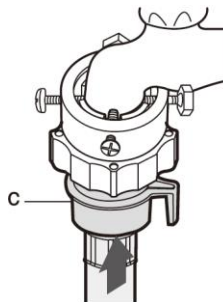

NOTICE:

- After completing connection, if water leakage from the hose, then repeat the same step.
- Use the most suitable type of faucet for water supply.
- If the end of the faucet is square or too big, please loosen the four screws. Unscrew and take out the bushing in the adaptor before inserting the end of the faucet into the adaptor.

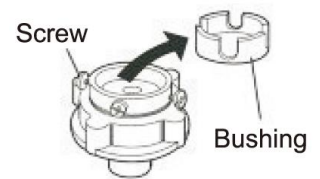

3.5 WATER DRAINING CONNECTION

- Before operating your washer, install drain hose properly. The other end of the drain should set as below.
- Never attempt to extend or modify the water drain hose.
- Do not put water drain hose from your appliance into a container, bucket or bathtub.
- Make sure that the water drain hose is not bent, buckled, crashed or extended.

<p>1. Don't exceed more than 3m when the drain hose is used by connecting with other hoses.</p>	<p>3. The doorsill shouldn't be taller 15cm.</p>
<p>2. Take note that the end of the drain hoses should not be immersed into water.</p>	<p>4. Don't install the drain hose underneath the washer.</p>

4. PRODUCT DESCRIPTION

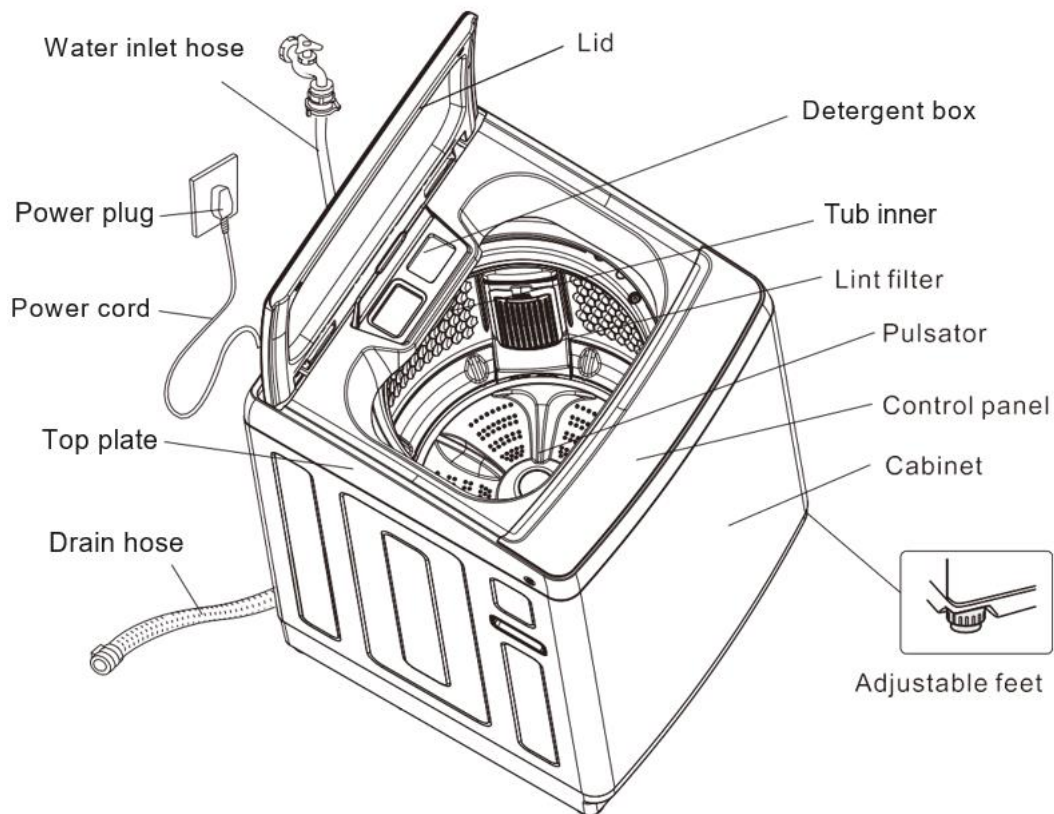

5. HOW TO USE YOUR WASHING MACHINE

Detergents

- Detergent or washing powder shall be selected according to fabric type, colors, washing temperatures, dirty degree and types.
- Bleacher belongs to alkaline type can damage clothes.
- Powder detergents can easily leave the residues in the clothes so as to generate the bad smell; hence they shall be sufficiently rinsed.
- Detergent cannot easily get dissolved completely if there is excessive or water temperature is low. It can remain in clothes and pipes to pollute the clothes.
- Washing shall follow the weight of clothes, dirtiness, local water hardness as well as the recommendations from the detergent manufacturers.
- Keep detergents and additives in a safe and dry place out of reach of children.

Care on the garment

- Please check the pockets of the clothes to be washed, empty the rigid items such as decorations and coins, otherwise the appliance may be damaged.
- The clothes to be washed are classified into cotton, blended fibre, synthetic fibre, silk, wool and artificial fiber. Follow the symbol type and make sure the clothes are suitable to wash in the washing machine.
- White and colorful garments shall be identified. All new colorful articles shall be washed in a separate cycle.

- The articles of different sizes are washed together to increase the washing effects.
- Soft articles shall be washed separately. As for new pure wool textiles, curtains and silks, the soft washing procedure shall be selected. Check the labels in all washing articles.
- The clothes shall be sorted before being put into washing machine. As for the curtains with hooks, the hooks shall be removed before being washed.
- The decorations on the clothes may damage the washing machine. As for the clothes with buttons or embroideries, they shall be turned over before being washed.
- Zips shall be zipped close and buttons or hooks shall be fixed. The loose band or ribbon shall be bound together.

Confirm the washing capacity

- Do not put excessive load into the washing machine. It may affect the washing effects.
- Please confirm the maximum affordable washing quantity.
- Washing machine shall not wash water-proof materials (ski suits, napkin pads, curtains).
- Do not wash the fiber products that water cannot get soaked easily into such as water-proof cushions and clothes. Otherwise there will be water bursting out or abnormal vibration to cause danger and that the clothes also may be damaged. (Such as outside napkin pads, raincoats, umbrella, ski suits, car covers, sleeping sacks etc.)

5.1 SORTING LAUNDRY BEFORE START

- Sort your laundry according to their type (cotton, synthetic, delicates, wool, etc), quantities, and dirtiness of the clothes to be washed.
- Never wash colored and white laundry together.
- Dark textiles may contain excess dye and should be washed separately several times before being included in a mixed load.
- Ensure that there are no metallic materials on your laundry or in the pockets; if so, remove them.
- Close zips and fasten any hooks and eyes.

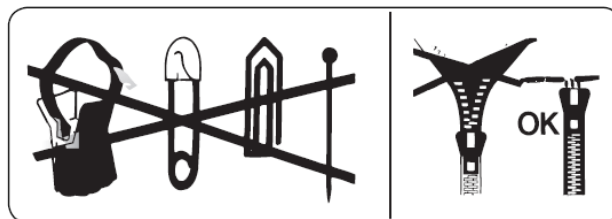



- Remove the metallic or plastic hooks of curtains or place them in a washing net or bag.
- Reverse textiles such as pants, knitwear, t-shirts and sweat shirts.
- Wash socks, handkerchiefs and other small items in a washing net.
- The surfaces of delicate textiles will have wrinkles and the working life of washing machine will be shortened.

NOTE:

Any malfunction occurred due to foreign materials damaging your machine or overloading of laundry are not covered by the warranty.

5.2 WASHING CLOTHES FOR THE FIRST TIME

Before washing clothes for the first time, you must run a complete cycle without clothes. To do this:

1. Press the  button.
2. Pour a little detergent into detergent box or the inner tub.
3. Turn on the water supply faucet to the washing machine.
4. Press the PROGRAM button, select TUB CLEAN program.
5. Press the  button.

5.3 PUT IN LAUNDRY

- The capacity of washing and spinning of the washer refers to the largest weight of the load that can be washed or spinning in one time. One time washing quantity shall be lower than the rated capacity.
- The thickness, size and type of the clothes will influence the actual capacity. It is suitable for one time washing to put in reasonable amount of laundries.

5.4 HOW TO PUT DETERGENT

Washing Powder Inlet

- Please put in the appropriate amount of washing powder according to the washing volume and select the amount of water.
- When choosing the quick wash program, it is recommended to use liquid detergent for better washing result.
- Detergent powder that is of poor quality or exposed for a long time may agglomerate. Please clean the detergent box frequently.

Liquid Detergent Inlet

- For the usage and dosage of liquid detergent, please follow the instructions of liquid detergent guideline. Please put the liquid detergent into the detergent inlet before start.
- The liquid detergent should not exceed the indication of "MAX" level.

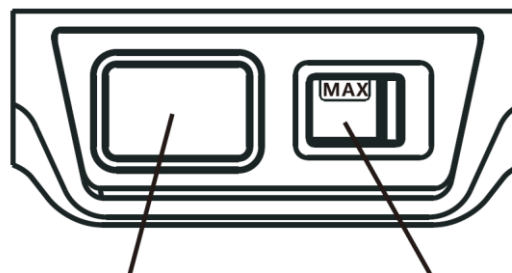

Washing powder inlet

Liquid detergent inlet

5.5 AUTOMATIC SENSING FUNCTION

- At every program the amount of laundry is automatically sensed while appropriate water level, washing time, rinsing cycle, and spinning time will be selected automatically.
- After the power has turned on, a program is selected and ▷|| button is pressed. The pulsator starts spinning without water, this action senses how much laundry is in the tub. After this sensing process, water will start to fill automatically.

5.6 ADDING DETERGENT

- The washing machine senses the amount of laundry and indicates the water level. Then, it starts water supply right away.
- When washing program started, water supply will flow into detergent inlet. You are able to add detergent during this process but it is required to press ▷|| button to stop water supply in order to add detergent. Close the lid and press ▷|| button again to continue.

NOTICE:

Be careful not to overload. Use right detergent for the laundry you are washing.

If the lid is open while running, the washing machine will be stopped automatically for safety. (Except, water supply continues while the lid is open).

6. PROGRAM SETTING

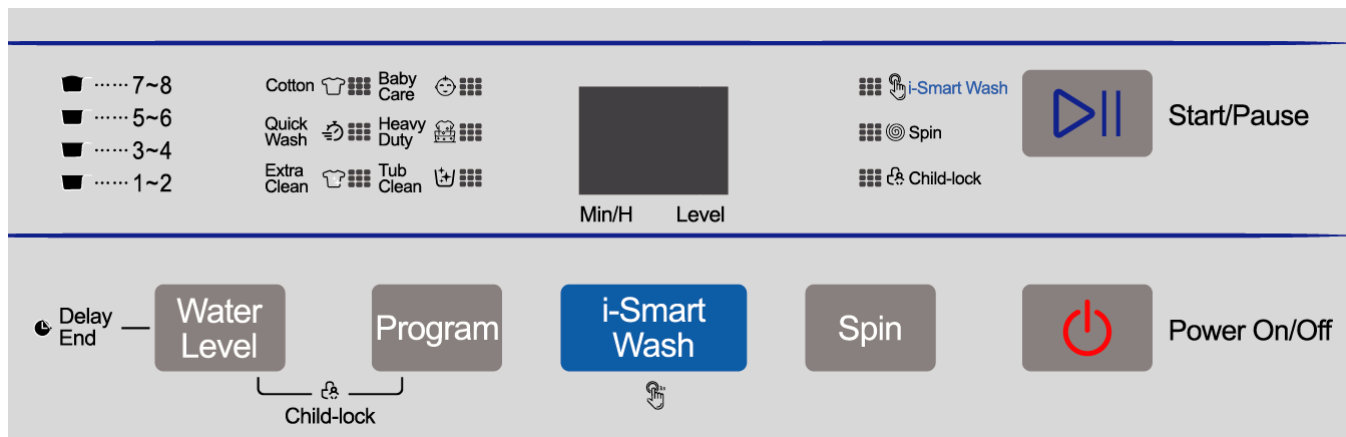

Cotton

You can select this program to wash the daily washable clothes. The washing period is longer with strong washing intensions. It is recommended to wash the daily cotton articles, for example: daily laundry, bed sheets, quilt covers, pillowcases, gowns, underwear etc.

Quick Wash

You can select this program on lightly soiled, cotton, colored and linen textiles. Due to the short washing time of this program, we recommend that less detergent is used. The program may last longer than 18 minutes if the washing machine detects an uneven load.

Extra Clean

You can select this program on dirty cotton, synthetic and synthetic-mixed shirts and blouses. The washing time is longer and having better washing result.

Baby Care

You can select this program for babies clothes, towels and bedding. This program is designed with added rinse time and washing time in order to have better washing result.

Heavy Duty

You can select this program for washing heavy stained laundry. This program is designed with added soaking time.

Tub Clean

This program is to clean the inner tub, please remove all the laundry before start.

Spin

This program is for spin only. Soap water or rinse water will be drained out before spinning.

Delay End

Delay end function will put the appliance to stop after the desire time has been elapsed.

Child Lock

This function is to lock the washing program to prevent misused by children. All buttons will be disabled except  button.

6.1 PROGRAM SELECTION



Once the washer is turned ON, press this program button to select the desired program. With every press of this button, the washing program changes. The washing program will follow this sequence: Cotton > Quick Wash > Extra Clean > Baby Care > Heavy Duty > Tub Clean.

Press the ▶|| button to start. Water level will be selected automatically. Washing cycle, rinsing, and spinning will follow according to the program that has been selected. If you want to pause, press the ▶|| button again. It is unable to change the program when paused. Close the lid and the washer will start to operate automatically.

6.2 WATER LEVEL SELECTION



For each washing program, the water level can be changed manually.

1. Press the ⏻ button and select the washing program.
2. All the program will automatically adjust the water level by sensing the laundry load. If you wish to have a different water level, you can click the "Water Level" button to your desired level.
3. The corresponding water level will show on the display screen.
4. Press the ▶|| button to start and then close the lid.
5. The washing program will operate based on the water level you have selected.

6.3 I-SMART WASH

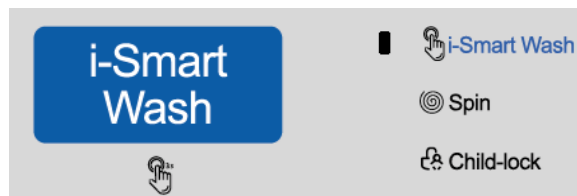

There are three methods to select the i-Smart Wash program.



Method 1:

When the ⏻ button is not pressed, press this button and hold for 3 seconds. The washer will sense the laundry automatically. The water level will be set automatically and start the washing program immediately.

Method 2:

Firstly, press the  button. Press this button and hold for 3 seconds, the washer will sense the laundry automatically. The water level will be set automatically and start the washing program immediately.

Method 3:

Firstly, press the  button. Press this button and then press  button, the washer will sense the laundry automatically. The water level will be set automatically and start the washing program immediately.

6.4 SPIN ONLY



There are three methods to select “Spin” program.



Method 1:

When  button is not pressed, press this button and hold for 3 seconds, the washer will operate Spin program immediately.

Method 2:

Firstly, press  button, then press this button and hold for 3 seconds, the washer will operate Spin program immediately.

Method 3:

Firstly, press the  button, then press this button, and then press  button, the washer will operate Spin program immediately.

6.5 DELAY END

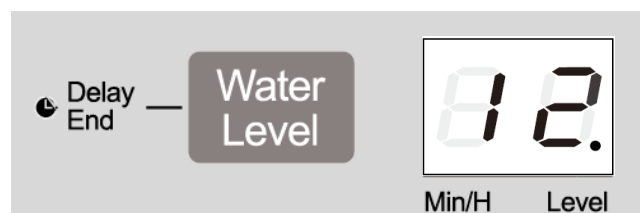

Press the “Water Level” button and hold for 3 seconds to activate the delay end function.

- The delay end timer will appear on the electronic display.
- Press the “Water Level” button until the desired delayed time appears on the display (from 0 to 24 hours).
- If you have skipped the delay time you wanted to set, keep pressing the Delay Start button until the desired delay time is displayed again.
- Select the program and then press  button to start. After that close the lid. The washing cycle will start by the time you reserved. For example, you have preset the delay end function for 2 hours and select the cotton program (49 minutes washing duration), the appliance will start on 1 hour 11 minutes later. The total end time for whole washing cycle will complete on 2 hours (which is preset delay end desired time).

6.6 CHILD LOCK

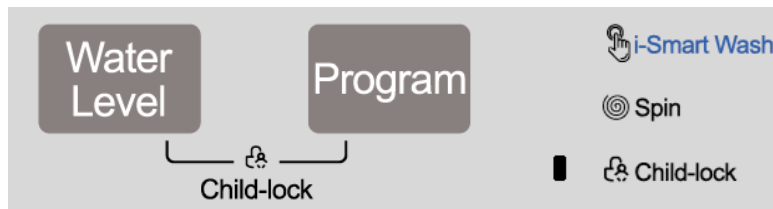

Once the washing program is running, press the “Water Level” button & “Program” button simultaneously and hold for 3 seconds to activate the child-lock function. All the button will be locked except the power button. The child lock indicator will appear on the display screen once it is activated. To release the child-lock function, press the “Water Level” button & “Program” button simultaneously and hold for 3 seconds again to cancel the function.

6.7 TUB CLEAN



To activate this function, press the program button to select “Tub Clean”. The self-cleaning function is used to clean the tub. This function performs sterilization to remove the stains and dirt from the inner wall of the tub to avoid the bacteria growth. Before activating this function, please do not put any clothes and detergent.

NOTE: It's recommended to perform this program once a month.

6.8 START/PAUSE BUTTON



After selecting the program, press the ▷|| button and then close the lid to start the program. Press the ▷|| button again if you wish to pause the program.

6.9 TABLE OF WASHING PROGRAM

Program	Recommended Capacity	Water Level	Duration (Hours)	Laundry Type
Cotton	10 kg	Automatic Sensing (Leve 1 – 8)	0:49	Lightly soiled, cottons and linen textiles
Quick Wash	1 kg	Automatic Sensing (Leve 1 – 8)	0:18	Lightly, soiled, cotton, colored and linen textiles. Due to short washing time of this program, it is recommend that less detergent is used. The program may last longer than 18 minutes if your washing machine detects an uneven load.
Extra Clean	6 kg	Automatic Sensing (Leve 1 – 8)	0:56	Dirty cotton, synthetic and synthetic-mixed shirts and blouses can be washed together. The wash time is longer and better washing effect.
Baby Care	5 kg	Automatic Sensing (Leve 1 – 8)	1:03	Recommended for babies clothes, towels and bedding.
Heavy Duty	6 kg	Automatic Sensing (Leve 1 – 8)	1:05	Suitable to wash heavy stained or wearable clothes. This program design with more soaking time.
Tub Clean	-	8	0:38	To perform the self-cleaning function to remove the stains and dirt from the inner wall. Do not put any clothes and detergent when activate.
Spin	6 kg	-	0:08	This cycle uses a spin to shorten drying times for heavy fabrics or special care items washed by hand.
i-Smart Wash	6 kg	Automatic Sensing (Leve 1 – 8)	0:49	Intelligent wash by auto sensing the laundry and water level will select automatically.

NOTE:

PROGRAM DURATION MAY VARY DEPENDING ON THE AMOUNT OF LAUNDRY, TAP WATER PRESSURE, AMBIENT TEMPERATURE AND SELECTED PROGRAMS.

Do not mix dry towels, cotton and linen textiles, synthetic and synthetic blended laundry together.

6.10 CANCELLING A PROGRAM

To cancel a running program at any time:

1. Press the ▷|| button to pause the program.
2. Press ⏻ button.
3. Your machine will stop the washing operation and the program will be interrupted.
4. Select any other program to drain the machine.
5. Your machine will perform the necessary draining operation and cancel the program.
6. You can now select and run a new program.

6.11 FINISHING PROGRAM

Your machine will stop by itself as soon as the program you have selected has completed.

- You can open the lid and remove the laundry.
- Leave the door of your machine open to allow the inner part of your machine to dry.
- Unplug your machine.
- Turn the water tap off.

7. CLEANING AND MAINTENANCE

Before cleaning or performing maintenance on your appliance, disconnect the appliance from the power supply. To extend the lifespan of your appliance, it must be cleaned frequently.

The enamel or stainless steel parts should be cleaned without using any abrasive powders or corrosive substances which could damage the surface. If the stains are difficult to be removed, use mild cleaner to clean the area.

7.1 CLEAN THE LINT FILTER

Clean the lint filter often to keep your washer clean.

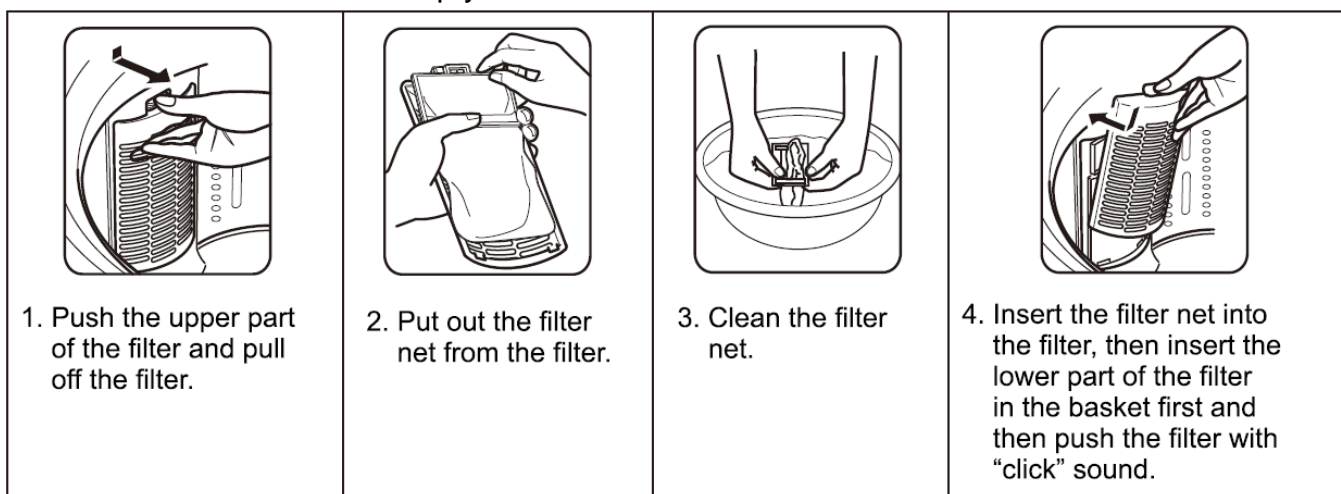

7.2 CLEANING THE WATER INLET FILTER

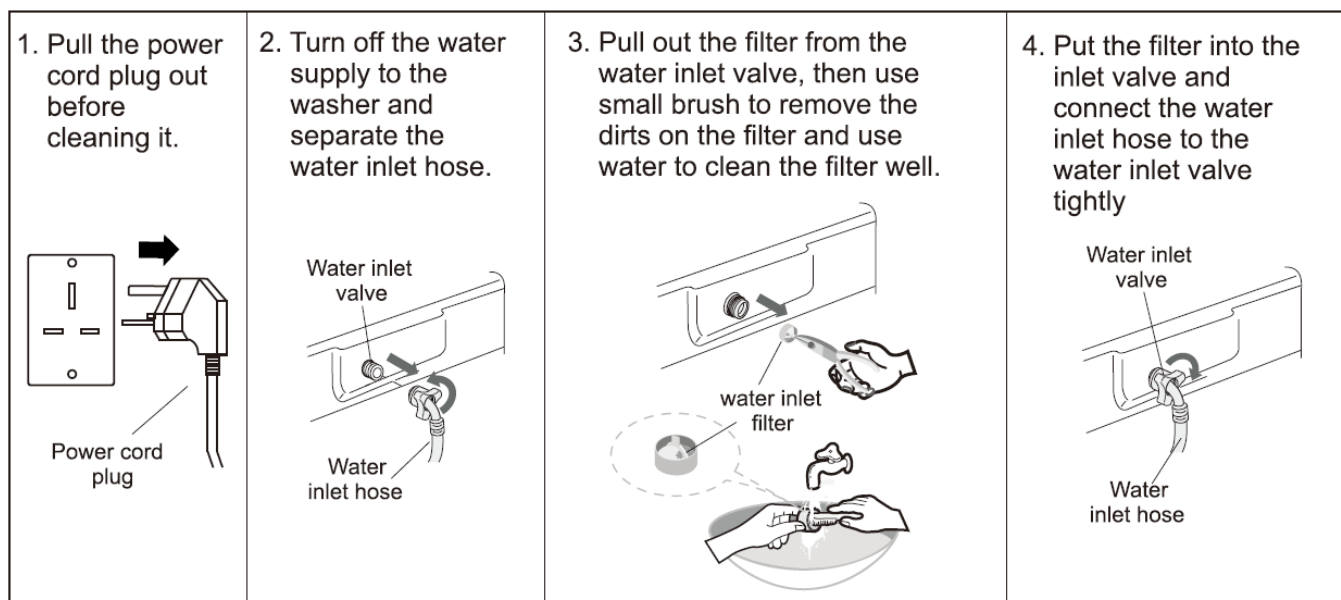

8. TROUBLESHOOTING

Troubles	Reason	Solution
Appliance cannot start up	Door is not closed properly. No power supplied. No water supplied. Function not set.	Check if the door is closed tightly. Check if power plug is inserted well. Check if water supply tap is opened. Check if button "Start/Pause" is pressed. Check if button "On/Off" is pressed.
Water leakage	The connection between inlet pipe or outlet hose and tap or washing machine is not tight. Drain pipe in the room is blocked.	Check and fasten water pipes connection. Clean up outlet hose and ask a specialized person for repair when necessary. Make sure the height of the piping is properly adjusted.
Indicator or display does not light.	Power is disconnected. PC board has problems.	Check if the power has turned on and power plug is connected correctly. Please contact service center for repair.
Detergent residues in the detergent compartment	Washing powder is dampened and agglomerated.	Clean and wipe the detergent compartment. Use liquid detergents or the detergents special for front loading washer.
Washing effects are not good	The clothes are too dirty. Insufficient detergent quantity. Wrong program chosen.	Select a proper washing program. Add the proper detergent quantity according to the instructions in detergent package.
Abnormal noise and vibration	Legs under the appliance have not adjusted in level.	Check if the appliance is installed on the solid and level floor. Check if the legs in the washing machine are adjusted level.

9. ERROR CODE

Faulty Code	Phenomenon	Inspection Point	Solution
E1	Spinning does not work	Does the washer put on a flat surface? Are the cloths too heavy or too large?	Reduce the number of clothes and press the start button again.
E2	No Water	Check if the tap is on/off. Ensure the filter has no blockage. Check if the pressure of water supply too low. Check if the water supply is continued.	If the inspection point is done. Press the start button again.
E3	Undrained	Ensure the drain pipe in the right place. Drain pipe height over 15cm Check if the drain pipe has been blocked?	If the inspection point is done. Press the start button again.
E4	Not Working	Check if the lid is open.	Please ensure the lid is closed. Press the start button again.
EL	Not Working	Check if the child lock function is activate and the lid is open.	If the child lock function is activated and the lid is open, the

			washer will not work. Please ensure the lid is closed. Press the start button again.
EA / EC	Alarm	-	Press the start button to reoperation. If still unable to solve the problem, please contact the after sales service center.

Electrical Warning

- To avoid the risk of fire, electrical shock and other accidents, please take note on the following:
 - i. Only the voltage indicated in power label can be used.
 - ii. Protect the power cord properly. Power cord shall be fixed well so that it will not trip the people or other things and be damaged. Special attention shall be paid to the socket. It shall be plugged into the sockets completely and attention shall be paid to the plug location.
 - iii. Do not make the wall-mounted socket overloaded or cable extended. Overloading of the wiring may cause fire or electrical shock. Do not pull out power plug with wet hand.
 - iv. To ensure your safety, power plug shall be inserted into an earthed three-pole socket. Carefully check and ensure that your socket is properly earthed.

10. TECHNICAL SPECIFICATION

Model	EWT-N1087D(GR)
Washing Capacity	10.0KG
Voltage	220–240V~
Frequency	50Hz
Rated Power	525W
Washing Container Capacity	65 L
Water inlet pressure (Mpa)	0.03 ~ 0.8
Gross Weight/Net Weight	37.5KGS/33.0KGS
Product Dimension (mm)	550 (W) x 935 (H) x 585 (D)

NOTICE

This product must not be disposed together with domestic waste. It has to be disposed at an authorized place for recycling of electrical and electronic appliances. By collecting and recycling waste, you help to save natural resources and make sure the product is disposed in an environmental friendly and healthy way.



ELBA