

ELBA

WASHING MACHINE
MODEL: EWDC-J1061IN(GD)

Owner's Manual

Please read this manual carefully before operating your set.

Retain it for future reference.

Record model number and serial number of the set.

See the label attached on the set and quote this information to your dealer when you require service.

For The Warranty Terms & Conditions, Please Refer To Warranty Certificate

We recommend that you read the instructions in this owner's manual carefully before using it for the best performance and to extend the lifespan of your appliance, as it will provide you with all the instructions you require to ensure its safe installation, use and maintenance.

1. SAFETY PRECAUTIONS

- To ensure your safety, all electric appliances should only be installed or serviced by qualified technician. If the supply cord is damaged, it must be replaced by the authorized service center or similarly qualified technician in order to avoid hazard.
- Do not place supply cord on the edge of table and counter, or near any heating appliance.
- In order to avoid electric shock, do not immerse supply cord, plug or other parts into water.
- Do not place the appliance near electric stove, heated oven or other heat source.
- In order to avoid burning or risk of fire, combustibles or flammable material (curtains, cloth, wallpaper and others) should be kept away from the appliance.
- When the appliance is not being used, everything should be removed from the drum.
- Accessible parts may become hazardous during use, please keep away from children.
- Disconnect the appliance from the power supply before cleaning or maintenance.
- When the appliance is faulty, please contact the authorized service center. Do not attempt to repair by yourself.
- Never use metal scouring pads or sharp scrapers which will damage the appliance surface or interior wall, leading to scratches of the enamel.
- In order to avoid hazard or electric shock, never put laundry exceeding the capacity.
- Please make sure the power has been switched off when the appliance is not in used.
- Unplug from the socket when you are planning not to use the appliance for long time.

2. ATTENTIONS

- In order to avoid electric shock, please make sure the appliance has been shut off before carrying out the maintenance.
- Use only original accessories provided by ELBA or its authorized service center.
- Do not use wet parts of the body to touch the appliance.
- Do not pull the appliance by its supply cord.
- The appliance should not be exposed to rain or direct sunshine.
- Do not use or store flammable objects near to the appliance.
- Always pull out the plug and cut off the water supply after the operation.
- Check the water inside the appliance has been drained before opening its door. Do not open the door if there is water visible.
- The appliance shall not be installed in bath room or wet rooms.
- Do not refill the water manually by hand while washing.
- After the washing cycle is completed, please wait for three minutes to open the door.

Distributors decline all liability for not following above instructions or some improper operations which caused personal injury and property loss.

3. INSTALLATION

3.1 Before the installation

- Please check the products and make sure there is no damage on the appliance.
- The appliance door is level, and you can open and close the appliance door flexibly.
- Specification on the marking plate is in compliance with the regulations.
- If the appliance appears in an abnormal way, do not install and unplug the power supply before contacting the authorized service center.
- Do not attempt to repair or service the appliance by yourself. Repair or maintenance should only be carried out by a qualified technician or the authorized service center.
- This appliance must be installed only by qualified technician or the authorized service center. Manufacturer declines all responsibility for improper installation, which may harm persons and cause damage to the property.
- The AC power supply should be supplied with 220-240V, 50Hz with minimum 10A distribution circuit fuse or circuit breaker.

3.2 Installation of the appliance

The material of the surroundings should be insulated, and the clearance between the edge of the cabinet and the appliance should be over 100mm for ventilation.

Remove the transport bolts

- Before operating the appliance, transport bolts must be removed from the rear of the appliance.
- Loosen all bolts by rotating anti-clockwise with a spanner.
- The transport bolts can then be removed with a straight pull. The removed transport bolts should be stored in case you need to transport your appliance in the future.
- Fit the lid into the holes to cover it.

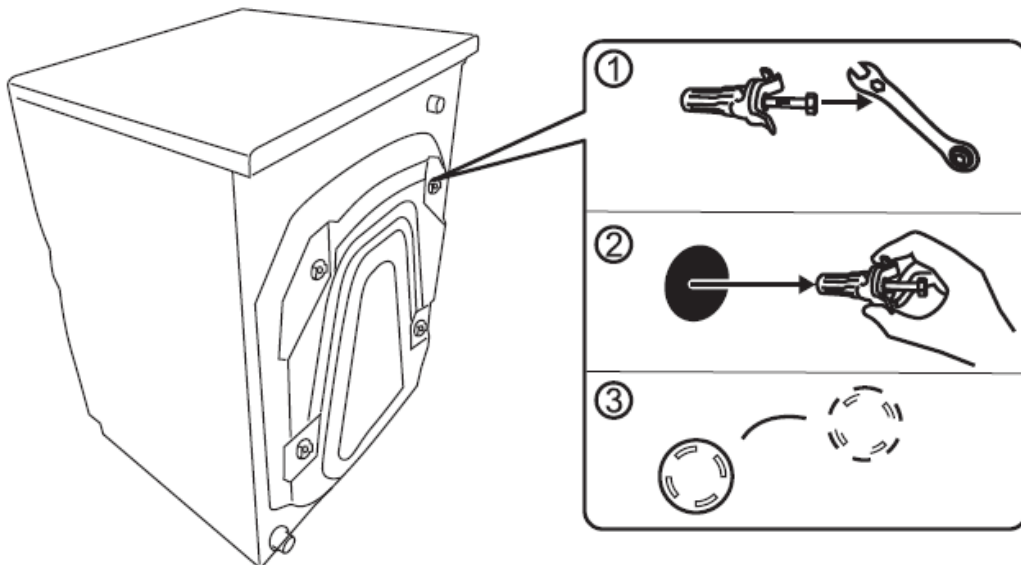

Adjust the bottom legs

- Do not install the appliance on a carpet or surface that will block ventilation at the base.

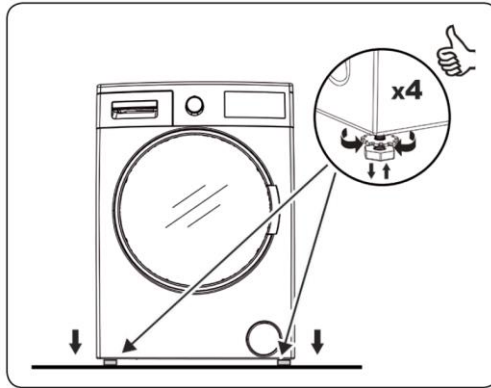

- To ensure silent and vibration-free operation of your appliance, install it on a firm surface.

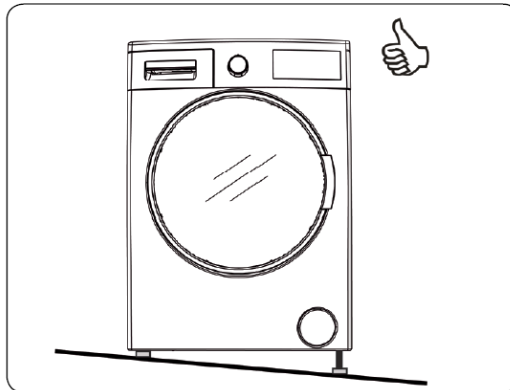

- You can adjust the level of your appliance by using the gauge at the top.

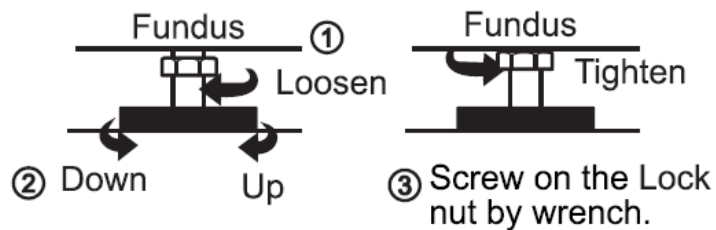

- You can level your appliance by using the adjustable feet:
 - Loosen the plastic adjustment nut.
 - Turn the feet clockwise to increase the height of the machine. Turn the feet anti-clockwise to decrease the height of the appliance.
 - Once the appliance is level, tighten the adjustment nut.
 - Never insert cardboard, wood or other similar materials under the machine to level it.



Connect the inlet and outlet pipe

- Connect your appliance to water supply.
- Connect the angled end of the water inlet hose to water inlet on the rear of the appliance turn the nut clockwise to tighten.
- Screw the other end of water inlet hose onto water tap and hand-tighten.
- Turn the water supply on and check for any leaks.

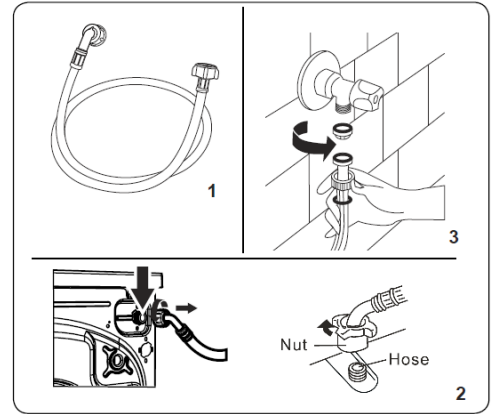

Water Draining Connection

- Connect the water drain hose to a standpipe or to the outlet elbow of a household sink, using additional equipment. The hose must be placed between 0cm and 80cm from the ground.
- Never attempt to extend the water drain hose.
- Do not put water drain hose from your appliance to a container, bucket or bathtub.
- Make sure that the water drain hose is not bent, buckled, crashed or extended.

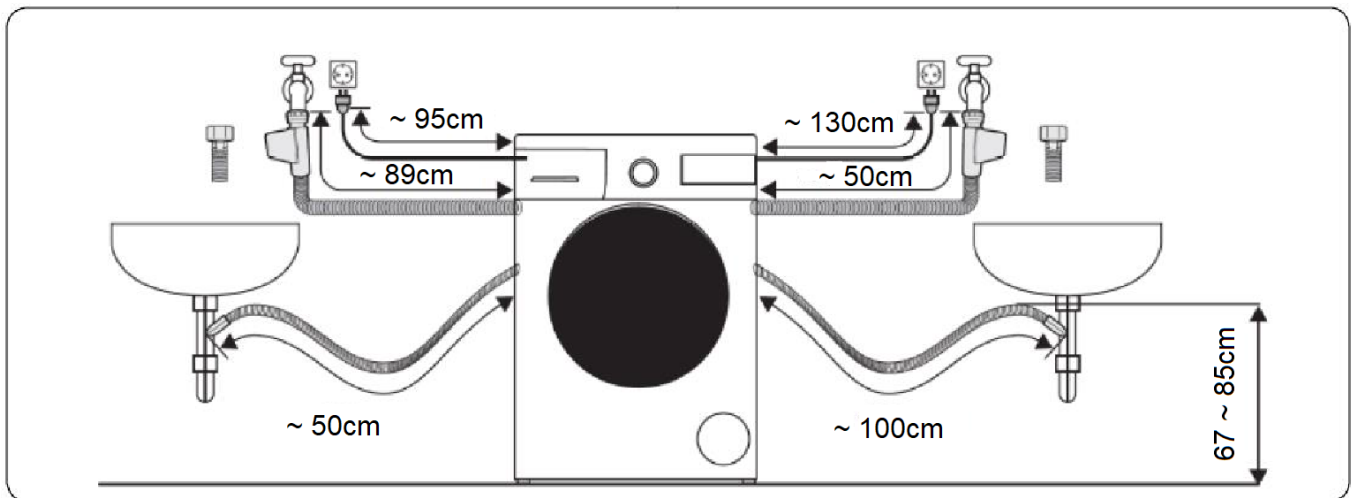

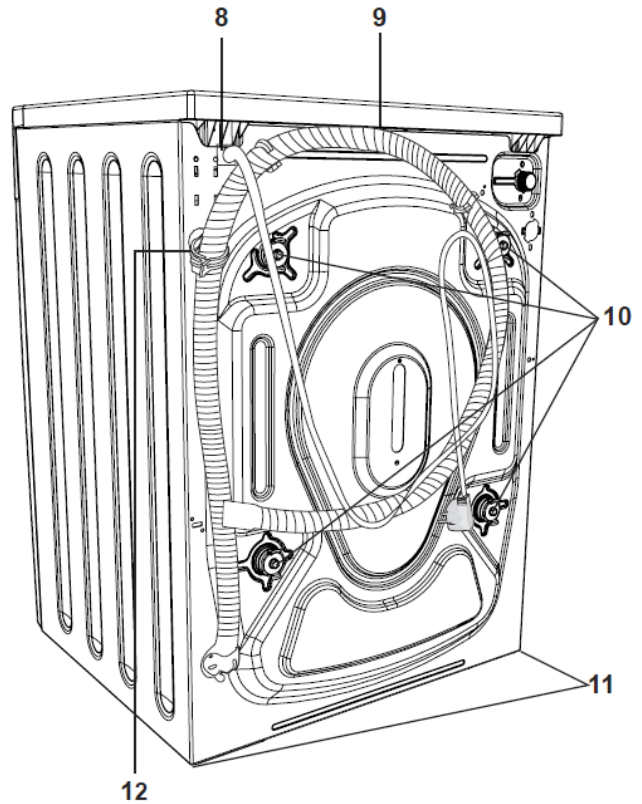
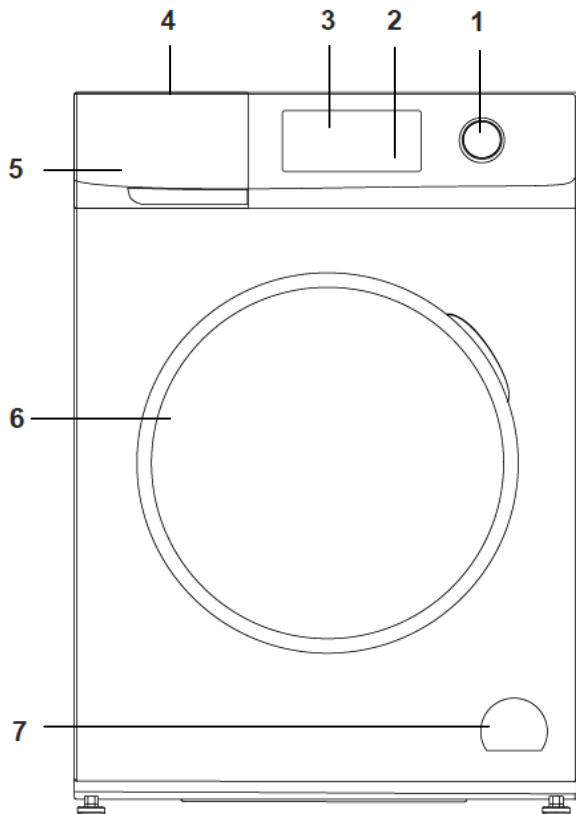

4. PRODUCT DESCRIPTION



1. Program Knob
2. Control Panel
3. Display Panel
4. Top Cover
5. Detergent Drawer
6. Door

7. Pump Filter Cover
8. Power Cord
9. Drain Hose
10. Transport Bolts
11. Adjustable Feet
12. Drain Hose Holder

5. ACCESSORIES

Instruction manual	Water Supply Hose	Lid (4Piece)
		

6. HOW TO USE YOUR WASHING MACHINE

Detergents

- “Low suds” detergent or washing powder shall be selected according to fabric type, colors, washing temperatures, dirty degree and types.
- Bleacher belongs to alkaline type can damage clothes.
- Powder detergents can easily leave the residues in the clothes so as to generate the bad smell; hence they shall be sufficiently rinsed.
- Detergent cannot easily get dissolved completely if there is excessive or water temperature is low. It can remain in clothes and pipes to pollute the clothes.
- Washing shall follow the weight of clothes, dirtiness, local water hardness as well as the recommendations from the detergent manufacturers.
- Keep detergents and additives in safe and dry places out of reach of children kids.

Care on the garment

- Please check the pockets of the clothes to be washed, empty the rigid items such as decorations and coins, otherwise the appliance may be damaged.
- The clothes to be washed are classified into cotton, blended fibre, synthetic fibre, silk, wool and artificial fiber. Follow the symbol type and make sure the clothes are suitable to wash in the washing machine.
- White and colorful garments shall be identified. All new colorful articles shall be washed in a separate way.
- The articles of different sizes are washed together to increase the washing effects.
- Soft articles shall be washed separately. As for new pure wool textiles, curtains and silks, the soft washing procedure shall be selected. Check the labels in all washing articles.
- The clothes shall be sorted before being put into washing machine. As for the curtains with hooks, the hooks shall be removed before being washed.
- The decorations on the clothes may damage the washing machine. As for the clothes with buttons or embroideries, they shall be turned over before being washed.
- Zips shall be zipped close and buttons or hooks shall be fixed. The loose band or ribbon shall be bound together.

Confirm the washing capacity

- Do not put excessive load into the washing machine. It may affect the washing effects.
- Please confirm the maximum affordable washing quantity according to the following:

Fiber Type	Maximum Loading Capacity
	10.0kg
Cotton	10.0kg
Synthetic	6.0kg
Wool	2.0kg

- Washing machine shall not wash water-proof materials (ski suits, napkin pads, curtains).
- Do not wash the fiber products that water cannot get soaked easily into such as water-proof cushions and clothes. Otherwise there will be water bursting out or abnormal vibration to cause danger and that the clothes also may be damaged. (Such as outside napkin pads, raincoats, umbrella, ski suits, car covers, sleeping sacks etc.)

Quick Start Guide

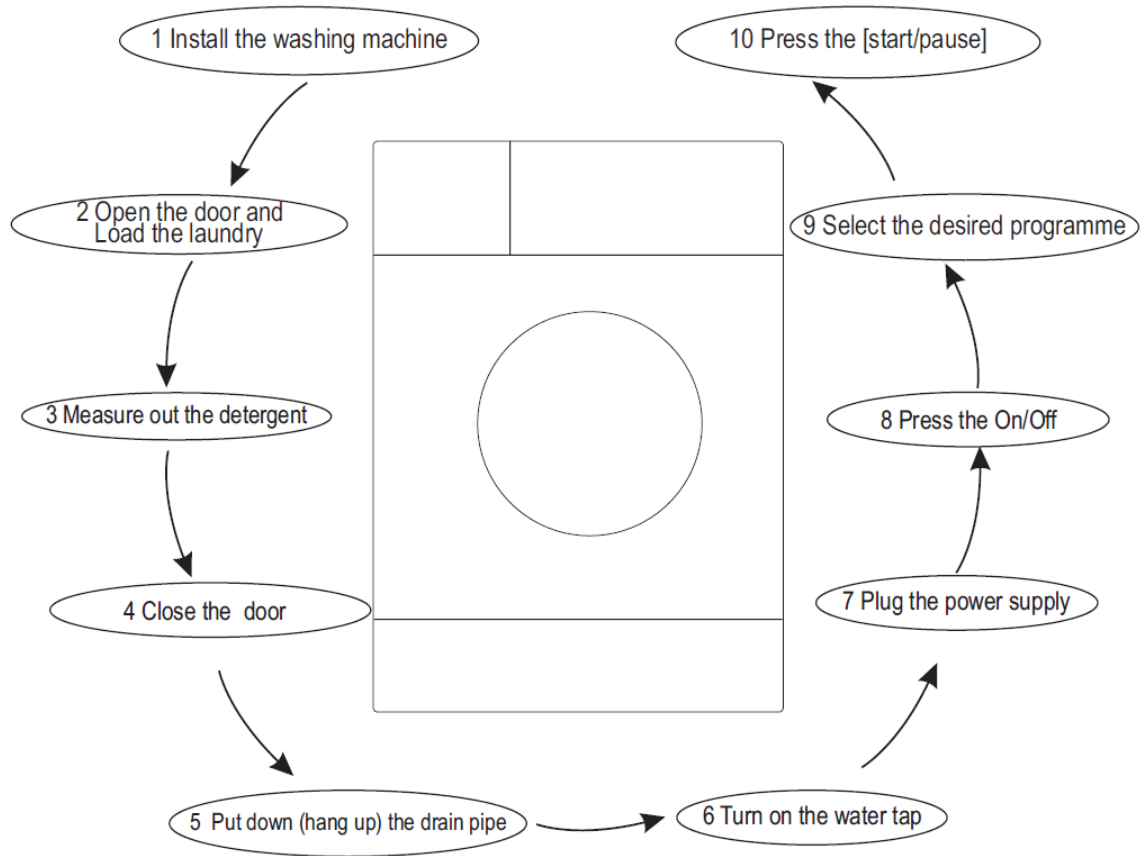

After the washing program completed:

1. Close the water tap.
2. Turn off the washing machine and disconnect the power plug.

WASHING CLOTHES FOR THE FIRST TIME

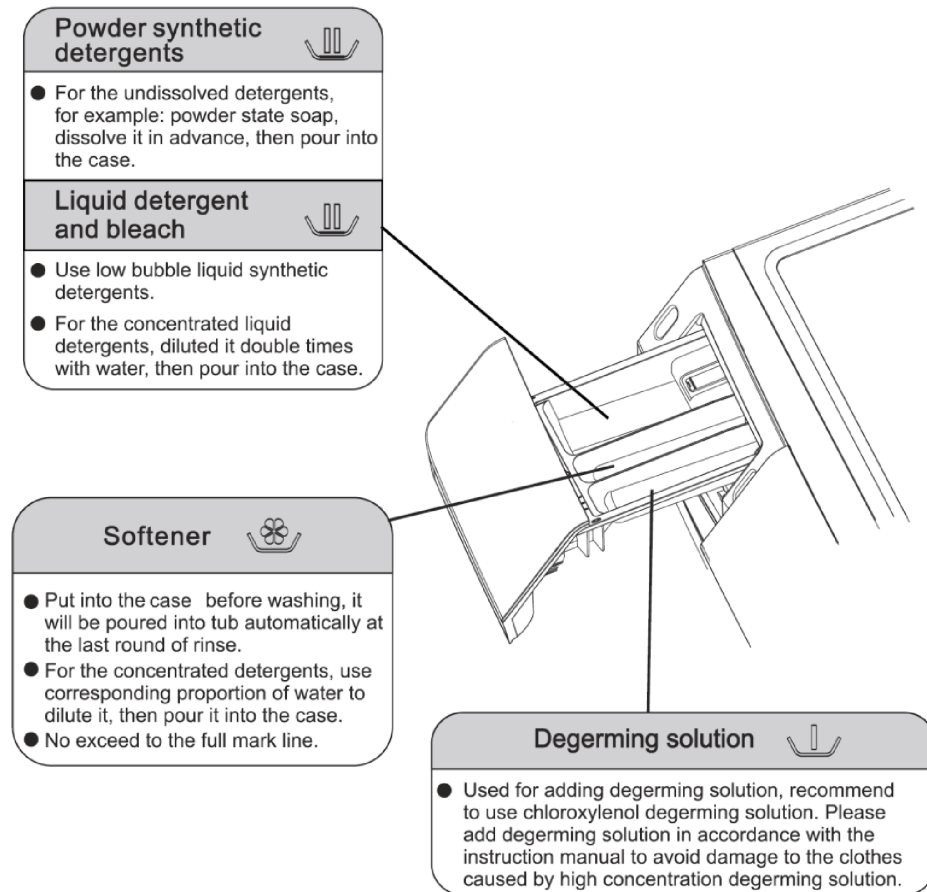

- Before washing clothes at first time, the washing machine shall be operated in one round of the whole procedures without clothes in as follows:

1. Connect power source and water.
2. Put a little detergent into the box and close it.
3. Press the button "On/Off".
4. Press the button "Start/Pause".
5. The drawer is separated as follows:
 - I : Pre-detergent for prewash.
 - II: Main detergent for main wash
 - : washing additive, such as fabric softener.

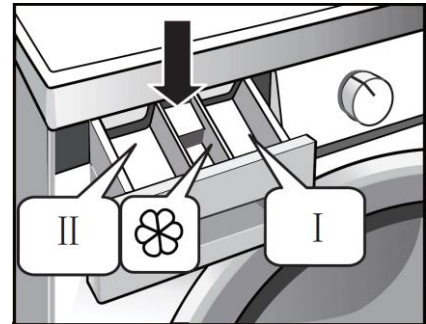





























Put detergent into washing machine.

1. Pull out the drawer.
2. Fill pre-detergent into Case I (when prewash function is selected).
3. Fill detergent into Case II.
4. Fill softener into Case  (when necessary).

NOTE:

Before detergents are poured into the detergent box, it is suggested to use some water for dilution to prevent the inlet of detergent box from being blocked and overflowing while filling water. Please choose suitable type of detergent for the various washing temperature to get the best washing effect with less water and energy consumption.

Explanation of Washing Symbols

 Machine wash	 Maximum ironing temperature 110°C
 Machine wash, permanent press	 Do not iron
  Maximum washing temperature 95°C	 Can be dry cleaned with any solvents
  Maximum washing water temperature 60°C	 Can only be cleaned with perchloride, lighter gas, alcohol or R113.
  Maximum washing water temperature 40°C	 Can only be cleaned with perchloride, lighter gas, alcohol or R113.
  Maximum washing water temperature 30°C	 Do not dry cleaning
 Hand wash	 Dry flat
 Do not wash	 Drip dry
 Can be bleached in cold water	 Line dry
 Do not use bleach.	 Tumble dry
 Maximum ironing temperature 200°C	 Tumble dry high
 Maximum ironing temperature 150°C	 Do not tumble dry

Sorting Laundry Before Start

- Sort your laundry according to their type (cotton, synthetic, delicates, wool, etc), quantities, and dirtiness of the clothes to be washed.

90°C	Seriously besmirched, pure white cotton or flax (for example: coffee table cloths, canteen table cloths, towels, bed sheets)
60°C	Moderately besmirched, colorful flax, cotton and synthetic articles with certain decolorizing degree (for example: shirts, night pajamas; Slightly besmirched, pure white flax)
40°C, 20°C, Cold Water	Normally besmirched articles (40°C ,20°C, for example: synthetic and wool)

- Select the proper temperature according to the dirtiness. Generally, the higher the temperature is, the more the power is consumed.

- Select the proper spinning speed required. The higher the spinning speed is, the drier the textiles are spun, but higher the noises will also be increased. To protect the clothes, the lower spinning speed shall be selected for delicate textiles.
- Never wash coloured and white laundry together.
- Dark textiles may contain excess dye and should be washed separately several times before being included in a mixed load.
- Ensure that there are no metallic materials on your laundry or in the pockets; if so, remove them.
- Close zips and fasten any hooks and eyes.

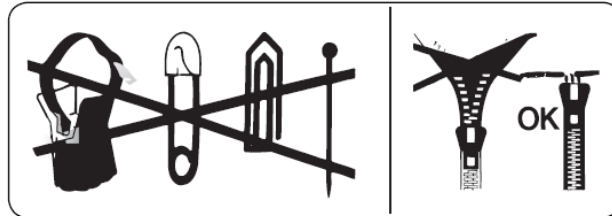

- Remove the metallic or plastic hooks of curtains or place them in a washing net or bag.
- Reverse textiles such as pants, knitwear, t-shirts and sweat shirts.
- Wash socks, handkerchiefs and other small items in a washing net.
- The surfaces of delicate textiles will have wrinkles and the working life of washing machine will be shortened.

NOTE:

Any malfunction occurring due to foreign materials damaging your machine are not covered by the warranty.

Placing Laundry Into the Appliance

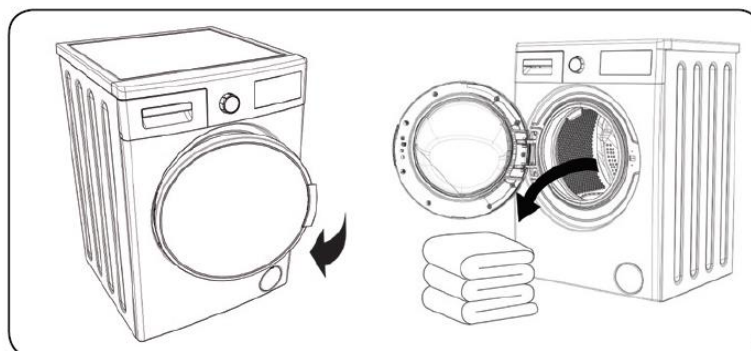

1. Open the loading door of your machine.
2. Check inside the drum. There may be laundry left inside from previous washes. If there is, empty your machine before selecting a program.
3. Load your laundry into the drum, ensuring it is loosely packed. Fold large objects like quilts and blankets into the drum as shown below:

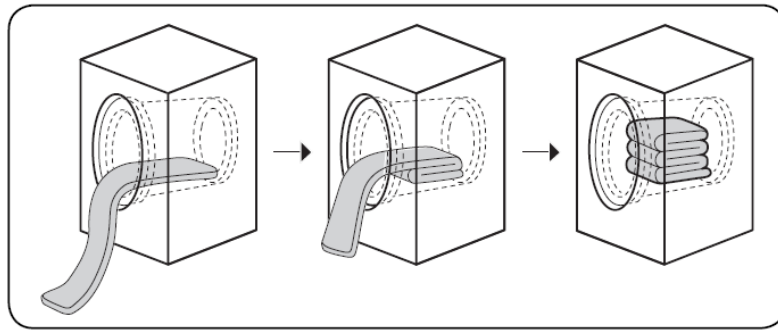

4. Place each item of laundry in separately.
5. Check that no items of laundry are trapped between the rubber seal and the door.
6. Make sure that the door is completely closed or the machine won't start the washing operation.

Choice of Detergent and Placing Into the Machine

- The amount of detergent to use will depend on the dirtiness of your clothes and the hardness of your water supply; guidelines will be on the packaging of your detergent.
- If your clothes are only slightly soiled, do not do a pre-wash. Put a small amount of detergent into compartment II of the detergent drawer.
- If your clothes are excessively soiled, select a program with pre-wash and put $\frac{1}{4}$ of the detergent to be used into compartment I of the detergent drawer and the rest in compartment II.
- Follow the instructions on the detergent packaging when determining the amount of detergent to use for your laundry
- The higher the degree of hardness of the water, the more detergent you will need.
- The amount of the detergent you will use will increase as the amount of your laundry increases.
- Put the softener in the softener compartment in the detergent drawer. Do not exceed the MAX level, otherwise the softener may flow into the washing water.
- Softeners with high density must be thinned before being put in the drawer. High-density softener will clog the flush and block the flow of the softener.
- You can use liquid detergent in all programs without pre-washing. Insert the liquid detergent apparatus in compartment II of the detergent drawer and adjust the liquid detergent amount (follow the instructions on the liquid detergent packaging). Do not exceed the MAX level.

7. PROGRAM SETTING

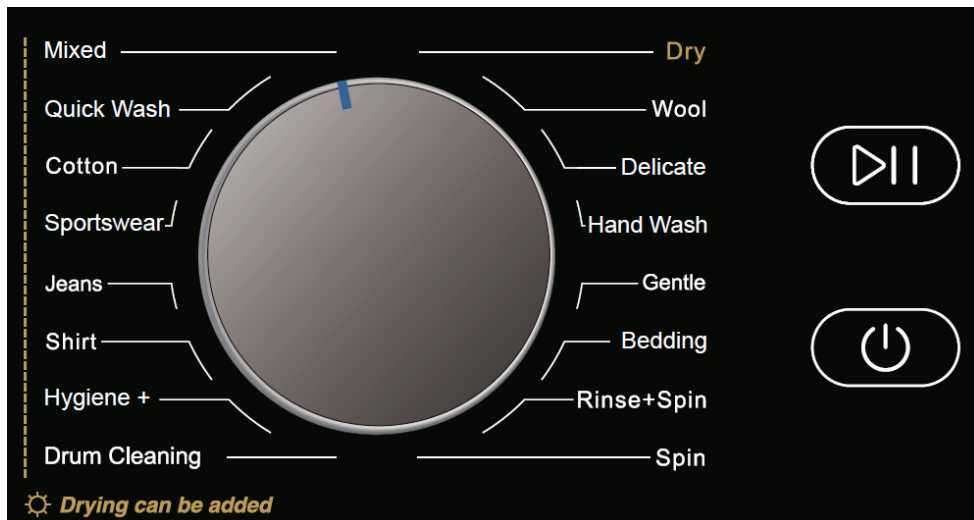

Mixed

You can select this program to wash the tough clothes that need much more time and strength. It is used for the daily clothes for cotton, such as sheets, chained, pillowcases bathrobe and underwear.

Quick Wash

You can select this program on lightly soiled, cotton, colored and linen textiles. Due to the short washing time of this program, we recommend that less detergent is used than with other programs. The program may last longer than 15 minutes if your washing machine detects an uneven load.

Cotton

You can select this program to wash the daily washable clothes. The washing period is longer with strong washing intensions. It is recommended to wash the daily cotton articles, for example: daily laundry, bed sheets, quilt covers, pillowcases, gowns, underwear etc.

Sportswear

You can select this program to wash the sports attire.

Jeans

This program is specially designed for washing jeans.

Shirt

The time duration for this program is 65 minutes with temperature 20° C with less laundry. Dirty cotton, synthetic and synthetic-mixed shirts and blouses can be washed together.

Hygiene +

This program can eliminate harmful bacterias and allergens to protect sensitive skins with high water temperature. It's recommended for babies's clothes, towels and bedding.

Drum Cleaning

This program is to clean the inner tub, please remove all the laundry before start.

Dry

This program is to dry the clothes only. Please select the drying time according to the loading.

Wool

You can select this program to wash the wool textiles labeled with "Machine Wash". Please select the proper washing temperature according to the label on the articles to be washed. A proper detergent shall be selected for wool textiles.

Delicate

You can select this program to wash your delicate clothes. Its washing intension is gentler and spinning speed is low. It is recommended for the articles to be washed softly.

Hand Wash

This program is used for hand wash or sensitive laundry such as innerwear. The movement will be slow and gentle and the default temperature of washing is 20° C.

Gentle

You can choose this program to wash fine textiles cloth.

Bedding

This program is specially designed for washing bedding laundry.

Rinse & Spin

This program is to rinse & spin separately.

Spin

This program is to spin only. Soap water or rinse water shall be drained out before spinning.

Delay Start

Delay start function will put the appliance to work after the desire time has been elapsed.

Child Lock

This function is to lock the washing program to prevent misused by children. All buttons do not work except On/Off button.

7.1 DRY FUNCTION

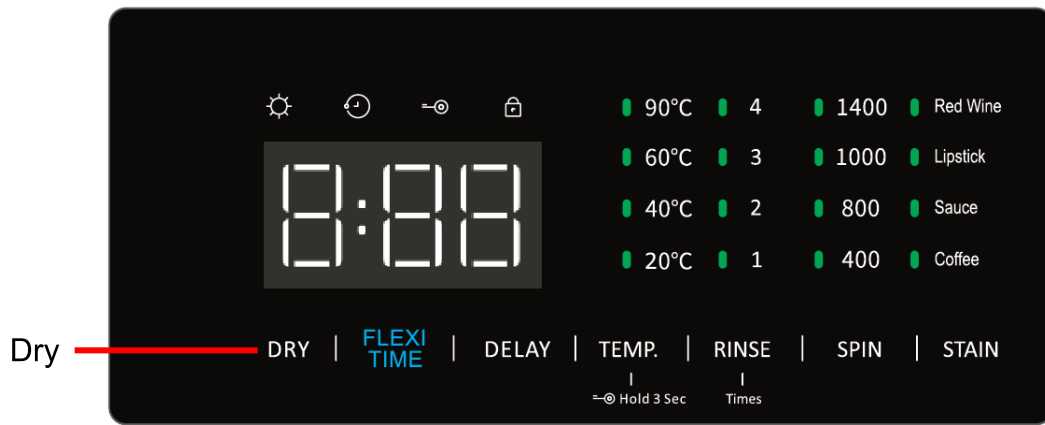

When you select a program, some of the programs have the selection of the dry function. Once you select the washing program, press the “Dry” button to activate the dry function after wash. If you wish to activate the timing drying, press the dry button to set the desired drying time.

NOTE: During the drying process, the water tap must be on because water is needed to cool down. Large or thicker textiles may not be drying completely in one cycle, user may adjust drying duration after the first cycle completed. Under the dry function, the delay start is unable to activate.

7.2 FLEXI TIME

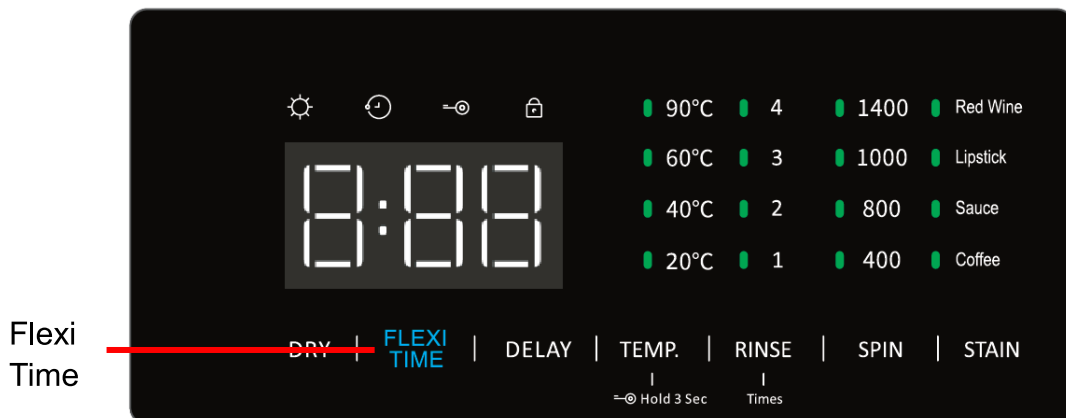

When you select a program, the washing duration for that program is automatically selected. To adjust the washing duration, press the flexi time adjustment button until the desired washing duration is displayed on the digital display. Program such as Hygiene +, Drum Cleaning and Dry is unable to activate this Flexi Time.

NOTE: If the washing duration has been reduced; the result of laundry might not be clean as expected.

7.3 DELAY START

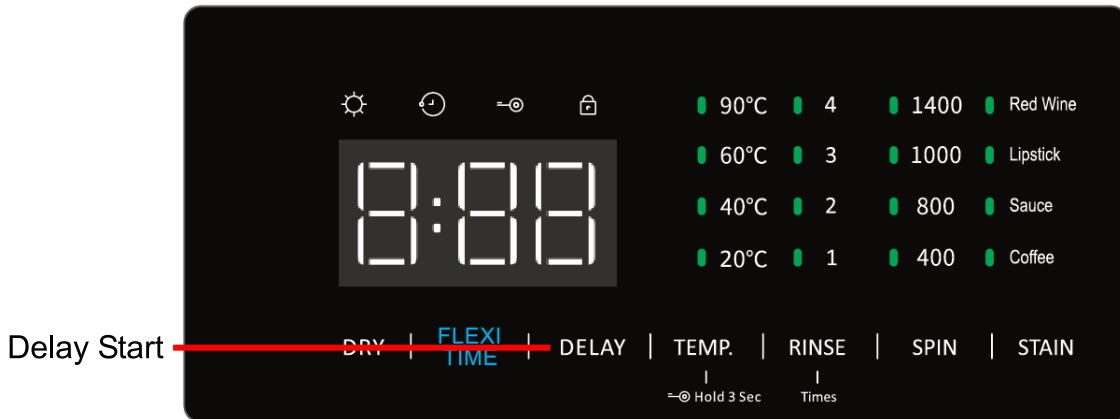

Press the Delay button once.

- The delay start hours will appear on the display.
- The delay start symbol will appear on the electronic display.
- Press the Delay Start button until the desired delayed time appears on the display.
- If you have skipped the delay time you wanted to set, keep pressing the Delay Start button until the desired delay time is displayed again.
- Then press ▷|| button to start.

7.4 TEMPERATURE SELECTION

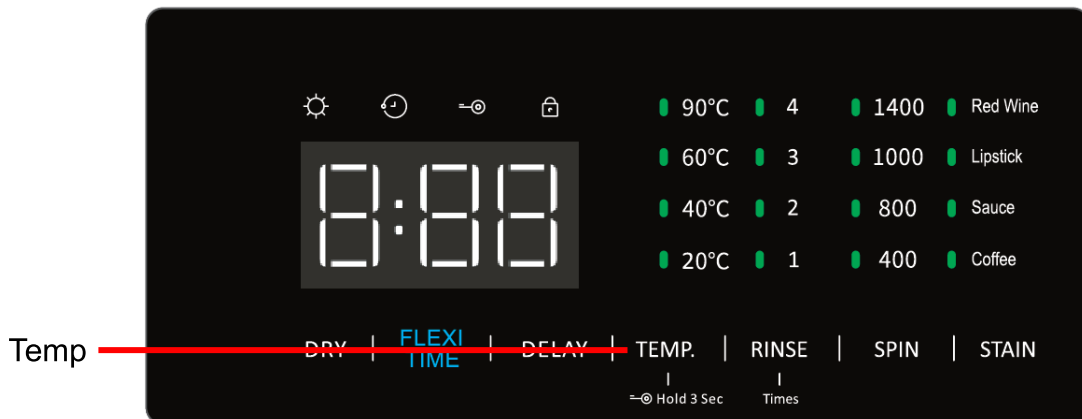

When you select a program, the temperature for that program is automatically selected. To adjust the temperature, press the water temperature adjustment button until the desired temperature is displayed on the digital display from 20° C, 40° C, 60° C, 90° C.

7.5 ADDITIONAL RINSE

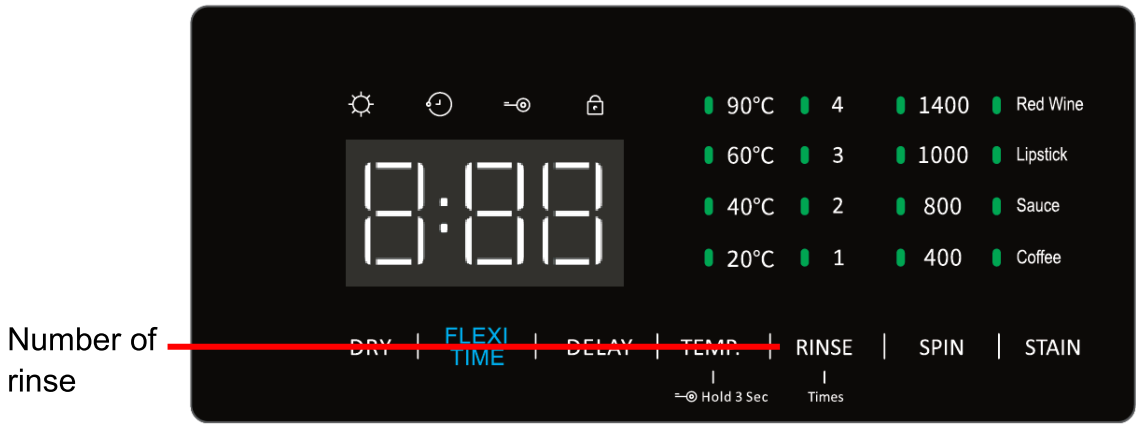

When you select a program, the rinse cycle for that program is preset. To add on additional rinse cycle, press the rinse adjustment button until the desired rinse is displayed on the digital display.

7.6 SPIN SPEED SELECTION

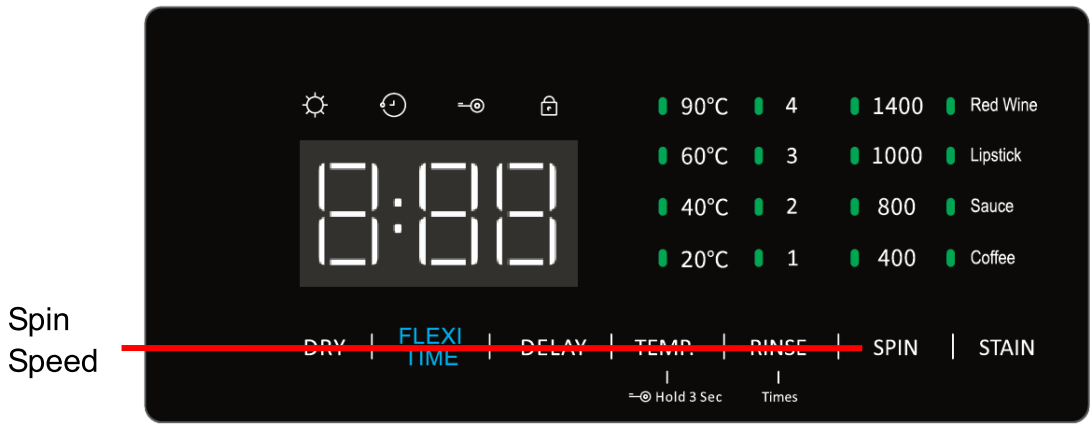

When you select a program, the spin speed for that program is automatically selected. To adjust the spin speed, press the spin speed adjustment button until the desired spin speed is displayed on the digital display from 400, 800, 1000, 1400 RPM.

7.7 STAIN WASH

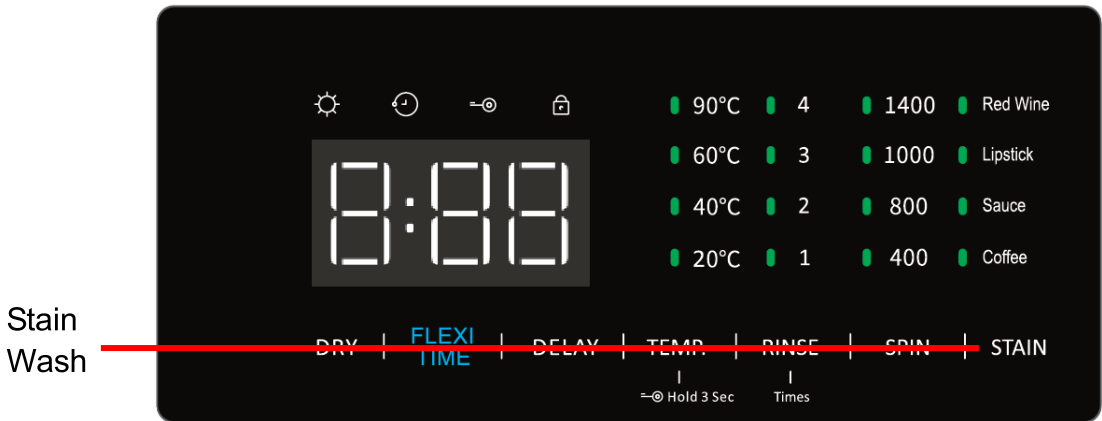

When you select a program, some of the programs have the selection of the stain type. Press the "Stain" button to remove the stubborn stains. The washer will perform three intensive wash cycles to remove stains in three different washing temperatures.

7.8 CHILD LOCK

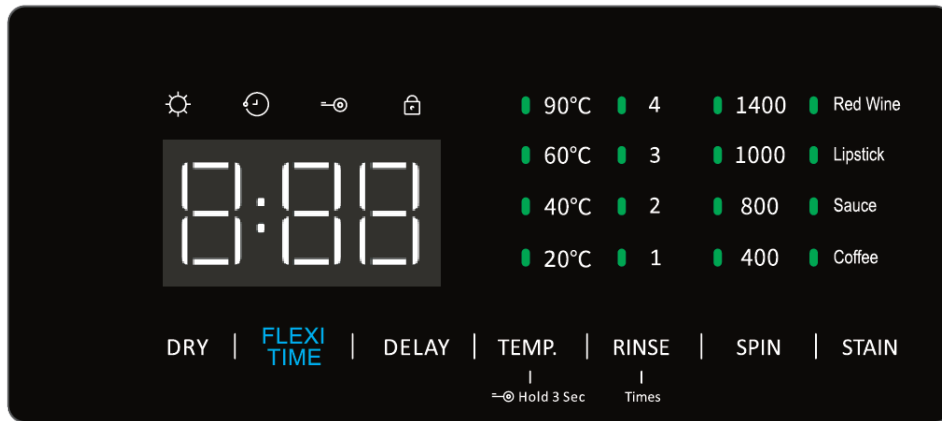

Press the “Temp” button for 3 seconds to activate the child lock function. The door will be lock and cannot open except the power button. The child lock indicator will appear on the display screen once it is activate. To release the child lock function, press the “Temp” button for 3 seconds again to cancel the function.

7.9 START/PAUSE BUTTON

After the selected program, press the ▷|| button to start the program. The door will be locked. Do not force to open the door as it will cause damage to parts. Press the ▷|| button again to pause the program.

7.10 ADD GARMENT FUNCTION

This operation can be executed during the early stage of the washing process. When the drum of the washing machine is still rolling and there is large amount of water with high temperature in the drum, it is unsafe and the door cannot be opened forcefully (If the washing cycle in the washing stage or water temperature is over 45° C, the door is not allowed to open). To open, press ▷|| button till the clock light off. Door lock is release and shows “Add”. Then add the clothes into the washing machine.

To add more garment:

- 1.Wait until the drum stops rotation.
- 2.The door switch is unlocked.
- 3.Close the door when the new batch of clothes are loaded and repress the ▷|| button to continue to wash.

NOTE: Do not force to open the door as it will cause damage to parts.

When there is a lot of foam or water in the drum, please use a dry towel to prevent foam and water from spilling out after opening the door.

7.11 DRUM CLEANING

To activate this function, turn the program dial to “Drum Cleaning”. The self-cleaning function is used to clean the tub. Heating up to 90° C of hot water performs sterilization to remove the stains and dirt from the inner wall of the tub to avoid the bacteria growth. Before activate this function, please do not put any clothes and detergent when activate.

NOTE: It’s recommended to perform one time/month.

7.12 TABLE OF WASHING PROGRAM

Program	Temperature (° C)	Washing Capacity	Dry Capacity	Duration (Hours)	Laundry Type
Mixed	Default 20° C (Selection: Cold - 60)	≤ 6kg	≤ 6kg	1:02	Mixed of the cotton, linen textiles and synthetics textiles.
Cotton	Default 20° C (Selection: Cold - 90)	8kg	≤ 10kg	1:07	Lightly soiled, cottons and linen textiles
Bedding	Default 20° C (Selection: Cold - 60)	≤ 5kg	-	1:17	Laundry recommended for bedding laundry.
Jeans	Default 20° C (Selection: Cold - 40)	≤ 5kg	≤ 5kg	1:07	Laundry recommended for jeans.
Wool	Default Cold (Selection: Cold - 40)	≤ 2kg	-	1:04	Wollen and wool blended textiles with a machine washable label.
Delicate	Default Cold (Selection: Cold - 40)	≤ 3kg	-	0:55	Laundry recommended for silk and delicate textiles.
Sportswear	Default 20° C (Selection: Cold - 40)	≤ 2kg	≤ 2kg	1:31	Laundry recommended for light sport wear.
Drum Cleaning	90° C	-	-	2:48	To perform the self-cleaning function to remove the stains and dirt from the inner wall. Do not put any clothes and detergent when activate.
Quick Wash	Default Cold (Selection Cold - 20)	≤ 1kg	≤ 1kg	0:15	Lightly, soiled, cotton, coloured and linen textiles. Due to short washing time of this program, it is recommend that less detergent is used. The program may last longer than 15 minutes if your washing machine detects an uneven load.
Gentle	Default Cold (Selection Cold - 40)	≤ 3kg	-	0:55	Laundry recommended for washing fine textiles.
Hand Wash	Default 20° C (Selection: Cold - 60)	≤ 3kg	-	1:21	Laundry recommended for hand wash or sensitive laundry such as innerwear.

Shirt	Default 20° C (Selection:Cold - 60)	≤ 3kg	≤ 3kg	1:05	Dirty cotton, synthetic and synthetic-mixed shirts and blouses can be washed together.
Hygiene +	90° C (Selection:60 - 90)	≤ 4kg	≤ 4kg	2:43	Recommended for babies clothes, towels and bedding.
Rinse & Spin	-	≤ 6kg	-	0:20	Provide the rinse and spin cycle to any type of laundry after the washing cycle.
Dry	-	-	≤ 5kg	1:00	To perform the dry only function.
Spin	-	≤ 6kg		0:11	Provide the spin cycle to any type of laundry.

NOTE:

PROGRAM DURATION MAY VARY DEPENDING ON THE AMOUNT OF LAUNDRY, TAP WATER, AMBIENT TEMPERATURE AND SELECTED ADDITIONAL FUNCTIONS.

If you select more than one additional function, the functions you select may be incompatible. Do not dry towels, cotton and linen textiles, synthetic and synthetic blended laundry together.

7.13 CANCELLING PROGRAM

To cancel a running program at any time:

1. Press the “” button.
2. Your machine will stop the washing operation and the program will be cancelled.
3. Turn the program dial to any other program to drain the machine.
4. Your machine will perform the necessary draining operation and cancel the program.
5. You can now select and run a new program.

7.14 FINISHING PROGRAM

Your machine will stop by itself as soon as the program you have selected finishes.

- You can open the machine’s door and remove the laundry.
- Leave the door of your machine open to allow the inner part of your machine to dry.
- Press the “” button.
- Unplug your machine.
- Turn the water tap off.

8. CLEANING AND MAINTENANCE

Before cleaning or performing maintenance on your appliance, disconnect the appliance from the power supply. To extend the lifespan of your appliance, it must be cleaned frequently.

The enamel or stainless steel parts should be cleaned without using any abrasive powders or corrosive substances which could damage the surface. If the stains are difficult to be removed, use mild cleaner to clean the area.

Cleaning the Detergent Box

1. Press down the arrow location on softener cover inside the drawer.
2. Lift the clip up and take out softener cover and wash the softener cover with water.
3. Restore the softener cover and push the drawer into position.

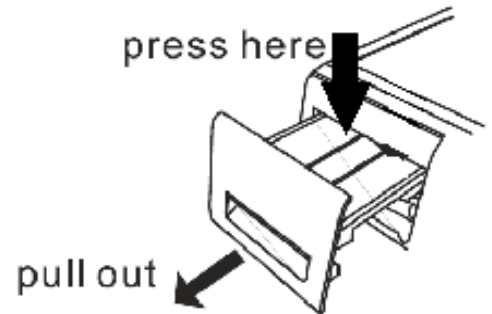

Cleaning the Inlet Filter

Inlet filter must be cleaned regularly if there is insufficient water.

1. Close the tap.
2. Select any procedure except "Wash" or "Drain" procedure.
3. Press the button "Start/Pause" and keep the procedure running for about 40 seconds.
4. Remove the inlet pipe from the tap.
5. Use water to wash the filter.
6. Reconnect the inlet pipe.

Washing the filter externally:

1. Screw off the inlet pipe from the backside of the machine.
2. Pull out the filter with long tip pliers and reinstall it back after being washed.
3. Reconnect the inlet pipe.
4. Open the tap and make sure there is no water leakage.
5. Close the tap.

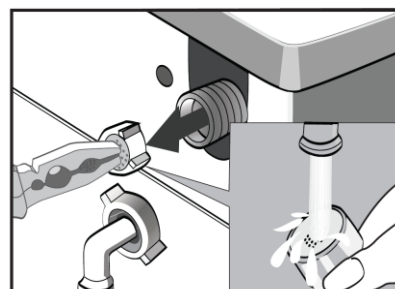
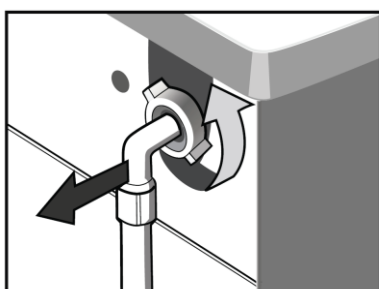

CLEANING THE PUMP

- The pump should be inspected if the machine does not empty and/or spin the machine makes an unusual noise during draining due to objects such as safety pins coins etc. blocking the pump. We recommend that you clean the pump filter every 2 months.

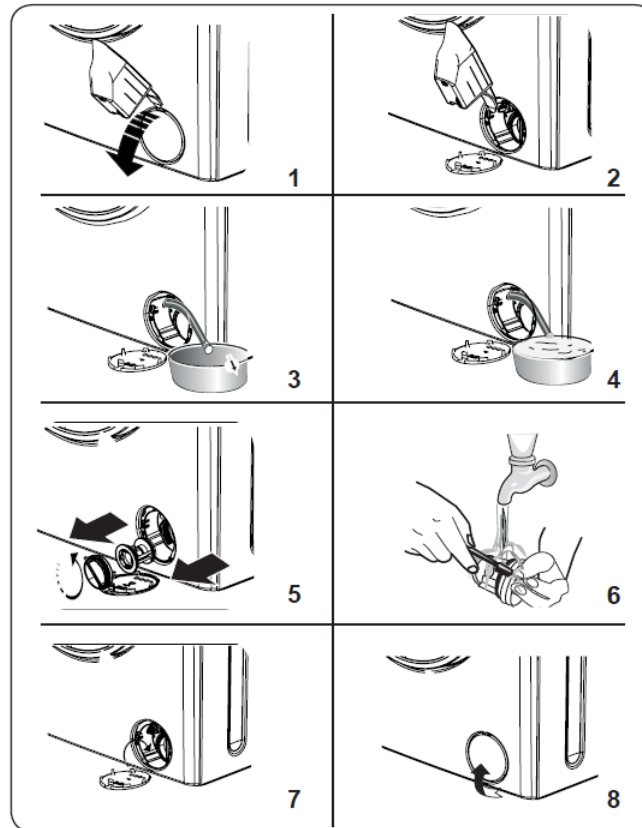

1. Disconnect the appliance and open the cover.
2. Wait until the remaining water has cooled down.
3. Open the bottom panel. Place a container close to the appliance to collect any spillage.
4. Collect the water drained from your machine in a container.
5. Loosen the filter cover by turning it anticlockwise and remove by pulling. Always get ready a cloth nearby to dry up spillage of water when removing the cover.
6. Remove any foreign materials from the filter with a soft brush.
7. After washing, restore the pump filter and screw the drain cover fully in.
8. Close the bottom panel.

NOTE:

When the appliance is in use and depending on the program selected there can be hot water in the pump. Never remove the drain cover during a wash cycle, always wait until the appliance has finished the cycle, and is empty. When replacing the drain cover, ensure it is securely retightened so as to stop leaks and young children being able to remove it.

9. TROUBLESHOOTING

Troubles	Reason	Solution
Appliance cannot start up	Door is not closed properly. No power supplied. No water supplied. Function not set.	Check if the door is closed tightly. Check if power plug is inserted well. Check if water supply tap is opened. Check if button "Start/Pause" is pressed. Check if button "On/Off" is pressed.
Door cannot be opened	Machine's safety protection is working.	Turn off the appliance and disconnect the power.
Heating faulty	Water temperature set to Cold or too low. NTC Sensor is damaged or heating pipe malfunctioned.	Select the proper washing temperature. Contact the service center for repair.
Water leakage	The connection between inlet pipe or outlet hose and tap or washing machine is not tight. Drain pipe in the room is blocked.	Check and fasten water pipes connection. Clean up outlet hose and ask a specialized person for repair when necessary. Make sure the height of the piping is properly adjusted.
Water overflowed from the bottom of the appliance	The inlet pipe is not connected firmly. Outlet hose has water leakage.	Fix the inlet pipe. Replace the drain hose.
Indicator or display does not light.	Power is disconnected. PC board has problems.	Check if the power has turned on and power plug is connected correctly. Please contact service center for repair.
Detergent residues in the detergent compartment	Washing powder is dampened and agglomerated.	Clean and wipe the detergent compartment. Use liquid detergents or the detergents special for front loading washer.
Washing effects are not good	The clothes are too dirty. Insufficient detergent quantity. Wrong program chosen.	Select a proper washing program. Add the proper detergent quantity according to the instructions in detergent package.
Abnormal noise and vibration	Transportation bolt not removed. Legs under the appliance have not adjusted in level.	Check if the fixing (bolts) has been removed. Check if the appliance is installed on the solid and level floor. Check if the legs in the washing machine are adjusted level.

Error Code

Faulty Code	Phenomenon	Inspection Point	Solution
E11	No Water	Check if the tap is on/off. Ensure the filter has no blockage. Check if the water supply is continued.	If the inspection point is done. Press the start button again.
E12	Undrained	Ensure the drain pipe in the right place. Drain pipe height too high. Check if the drain pipe has been blocked?	If the inspection point is done. Press the start button again.
H	Door cannot open	Make sure do not use hot water. The water temperature is high when washing. Water level inside the drum is high. The temperature is high when drying.	Automatically unlock if the temperature is back to safety level.
U3	No dehydration	Does the washer put on a flat surface? Are the cloths too heavy or too large?	Reduce the number of clothes and press the start button again.
U4	Door not closed	-	Close the door, then press the start button to resume.
Other Code	Alarm	-	Press the start button to reoperation. If still unable to solve the problem, please contact the after sales service center.

Electrical Warning

- To avoid fire, electrical shock and other accidents, please take note on the following:
 - i. Only the voltage indicated in power label can be used.
 - ii. When you are using the heating function, the maximum current through the washer dryer machine will reach 10A. Therefore, please make sure the power supply units (current, voltage and cable) can meet the normal load requirements for the machine.
 - iii. Protect the power cord properly. Power cord shall be fixed well so that it will not trip the people or other things and be damaged. Special attention shall be paid to the socket. It shall be plugged into the sockets completely and attention shall be paid to the plug location.
 - iv. Do not make the wall-mounted socket overloaded or cable extended. Overloading of the wiring may cause fire or electrical shock. Do not pull out power plug with wet hand.
 - v. To ensure your safety, power plug shall be inserted into an earthed three-pole socket. Carefully check and ensure that your socket is properly earthed.

10. TECHNICAL SPECIFICATION

Model	EWDC-J1016IN(GD)
Washing Capacity	10.0KG
Drying Capacity	6.0KG
Voltage	220-240V~
Frequency	50Hz
Rated Power	1850W
Product Dimension (mm)	600 (W) x 850 (H) x 635 (D)

NOTICE

This product must not be disposed together with domestic waste. It has to be disposed at an authorized place for recycling of electrical and electronic appliances. By collecting and recycling waste, you help to save natural resources and make sure the product is disposed in an environmental friendly and healthy way.



ELBA