



ELBA

**STAND FAN
MODEL: ESF-H1649TM(BK)**

Owner's Manual

Please read this manual carefully before operating your set.

Retain it for future reference.

Record model number and serial number of the set.

See the label attached on the set and quote this information to your dealer when you require service.

For The Warranty Terms & Conditions, Please Refer To Warranty Certificate.

REMOVE ALL PACKING MATERIALS FROM THIS PRODUCT BEFORE USING IT.

THIS APPLIANCE MUST BE INSTALLED ON A FLAT SURFACE. PLEASE ENSURE THE ELECTRIC SUPPLY TO THIS APPLIANCE IS DISCONNECTED

Please read this instruction carefully. It is advisable to keep this instruction manual in a safe place for future reference.

SAFETY PRECAUTIONS

1. Keep electrical appliances out of reach from children. Do not let them operate the appliances without supervision.
2. To protect against the risk of electrical shock, do not immerse the product, cord or plug into water or any other liquid.
3. This product is for household and indoor use only.
4. This product is not intended for use by person (including children) with reduced physical, sensory or mental capabilities unless they have been given supervision or instruction concerning use of the appliance by a person responsible for their safety.
5. If the power cord or plug is damaged, it must be replaced by the service center or a qualified service technician to avoid hazard.

WARNING - to reduce the risk of fire, electrical shock or injury to persons or property, please read and follow below instructions carefully.

- Always operate the product from a power source of the same voltage, frequency and rating as indicated on the product identification marking.
- Do not operate this product if it has malfunctioned, damaged cord or plug or appears damaged in any way. Return the complete product to the place of purchase for inspection, repair or replacement.
- This product should not be used in the immediate vicinity of water, such as bathtub, washbowls, swimming pool etc, where the likelihood of immersion or splashing could occur.
- Always switch off and unplug the plug from outlet when not in use, before assembling or disassembling parts and before cleaning. Fully assemble the fan before operating.
- Avoid contacting with moving parts. Do not insert any object through the guard when the fan is operating.
- Do not cover the guard or operate in close proximity to curtains, etc.
- Always disconnect the fan when moving it from one location to another.

PRODUCT DESCRIPTIONS

- | | |
|----------------|----------------------------|
| 1. Centre ring | 9. OSC knob |
| 2. Front guard | 10. Timer switch |
| 3. Guard ring | 11. Speed button |
| 4. Spinner | 12. Internal pole |
| 5. Fan blade | 13. Height adjustment ring |
| 6. Guard nut | 14. Extension pole |
| 7. Rear guard | 15. Round base |
| 8. Motor | 16. Base screw |

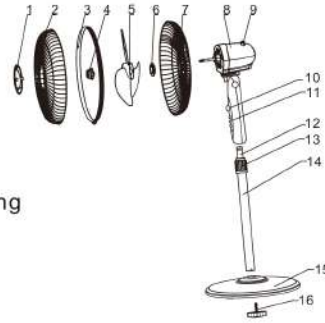

ASSEMBLY INSTRUCTIONS

1. Open the gift box and check the parts by referring to the product description drawing.
2. Insert the standing pole into the base and fasten the base screw. (Fig 1)
3. Loosen the height adjustment ring and adjust the internal pole to the desired height. (Note: If you can't see the internal pole, it may slide inside the standing pole. You can pull it out. Fig 2)
4. Loosen the thumb screw on the back of the fan body and attach it to the internal pole.
5. Fasten the thumb screw in alignment with the groove on the internal pole. (Fig 3)

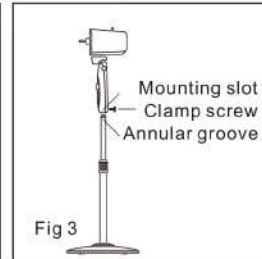
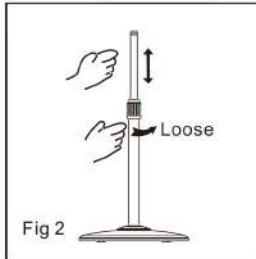
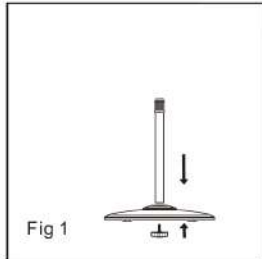

FAN BLADE AND GUARDS ASSEMBLY

1. Remove the spinner & guard nut from the motor shaft. Fix the rear guard to the front motor cover, then fasten the guard nut again. (Fig 4)
2. Fix the fan blade to the motor shaft and make sure the shaft pin is fit into groove of the blade. Turn the spinner counter-clockwise to fasten the blade. (Fig 5)
3. Fix both fan guards with the guard ring and use a screwdriver to lock the screw. (Fig 6)

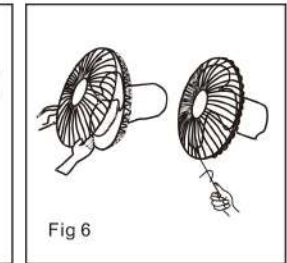
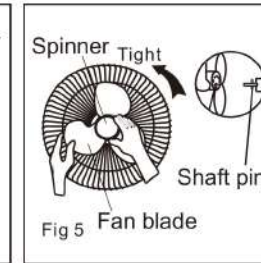
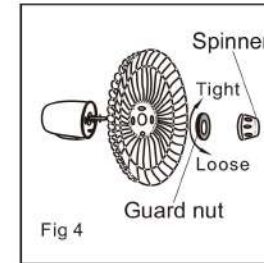

OPERATING INSTRUCTION

1. Press buttons for speed control: "0" for OFF; "1" for Low speed; "2" for Medium speed; "3" for High speed.
2. Turn the timer switch to set operation time from 1 to 120 minutes. If the timer is switched to "ON" position, the fan will run continuously.
3. Press or pull up the OSC knob to control the fan oscillation. (Fig 7)
4. The height of the fan can be changed by adjusting the internal standing pole.

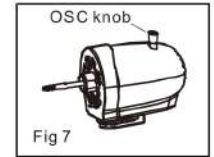

CLEANING AND MAINTENANCE

Clean the appliance with a damp cloth with mild cleaner. Do not use chemical, steel, wooden or abrasive cleaners to clean the appliance.

WARNING: DO NOT IMMERSE THE APPLIANCE INTO WATER. ENSURE THAT THE FAN IS UNPLUGGED FROM THE POWER SUPPLY BEFORE REMOVING THE GUARD.

MAIN SPECIFICATION

Voltage :220-240V/50Hz
Rated Power :50W
Fan Size :16-inch
Motor :3-Speed

NOTICE

This product must not be disposed together with domestic waste. It has to be disposed at an authorized place for recycling of electrical and electronic appliances. By collecting and recycling waste, you help to save natural resources and make sure the product is disposed in an environmental friendly and healthy way.



ELBA