

ELBA

DOUBLE DOOR REFRIGERATOR MODEL: ER-Q4357IN(GR)

Owner's Manual

Please read this manual carefully before operating your set.

Retain it for future reference.

Record model number and serial number of the set.

See the label attached on the set and quote this information to your dealer when you require service.

For The Warranty Terms & Conditions, Please Refer To Warranty Certificate

CONTENTS

1. SAFETY PRECAUTIONS	1
2. INSTALLATION	2-3
3. PRODUCT DESCRIPTION	4
3.1 OVERVIEW.....	4
3.2 CONTROL PANEL.....	5
3.3 COMPARTMENTS OVERVIEW.....	6-7
4. DAILY TIPS	8
4.1 FREEZING FRESH FOOD.....	8
4.2 RECOMMENDATIONS FOR PRESERVATION OF FROZEN FOOD.....	8
4.3 DEFROSTING.....	8
5. CLEANING AND MAINTENANCE	9
6. TROUBLESHOOTING	10
7. MAIN SPECIFICATION	10

REMOVE ALL PACKING MATERIALS FROM THIS APPLIANCE BEFORE USING IT. THIS APPLIANCE MUST BE INSTALLED ON A FLAT SURFACE. PLEASE ENSURE THE ELECTRICITY SUPPLY TO THIS APPLIANCE IS DISCONNECTED BEFORE INSTALLING.

Please read this instruction carefully. It is advisable to keep this instruction manual in a safe place for future reference.

1. SAFETY PRECAUTIONS

- Keep this appliance out of reach from children. Do not let them to operate the appliance without supervision.
- Check the current rating on the rating plate and make sure the current supplied is matched with the appliance before using.
- This appliance must be stationed at least 10cm away from the surrounding objects. There should not be anything to be placed on top of the appliance.
- This appliance is for household and indoor use only.
- This appliance is not intended for use by person (including children) with reduced physical, sensory or mental capabilities unless they have been given supervision or instruction concerning use of the appliance by a person responsible for their safety.
- If the power cord or plug is damaged, it must be replaced by the service centre or a qualified service technician to avoid hazard.
- This appliance should not be placed near possible heating resources or under direct sunlight to avoid decreasing the efficiency of refrigeration.
- This appliance should be placed in a cool dry place where there is no vicinity of water splashing or high humidity.

WARNING - to reduce the risk of fire, electrical shock or injury to persons or property, please read and follow below instructions carefully:

- Always operate the appliance from a power source of the same voltage, frequency and rating as indicated on the appliance identification marking.
- Do not operate this appliance if it has malfunctioned, damaged cord or plug or appears damaged in any way. Return the complete product to the place of purchase for inspection, repair or replacement.
- This appliance should not be used in the immediate vicinity of water, such as bathtub, washbowls, swimming pool etc. where the likelihood of splashing could occur.
- Always switch off and unplug the plug from outlet when not in use and before cleaning.
- When the appliance is operating, the condenser and compressor will be hot.
- This appliance must be grounded and the ground wire should not be connected to any heating pipe and gas pipe.
- Do not place carbonated or fizzy drinks into the freezer.
- Do not attempt to touch the freezer when your hand is damp or wet as this could cause skin abrasions or frost burns.
- This appliance is designed to operate in ambient temperatures (surrounding air temperature) between 16°C and 32°C.
- This appliance will create frost in the door seal if the appliance door seal is not in good condition or door is opened frequently.

2. INSTALLATION

1. This appliance is heavy. Care should be taken when moving it.
2. When you transport the appliance, the angle between the compartment body and the ground should not be less than 45°.

WARNING: *Never put the appliance upside down.*

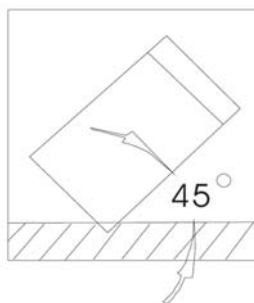

3. Once the appliance has landed properly on a flat and stable surface, remove all the packing material including any plastic packaging material in the appliance.
4. Keep your refrigerator away from heat sources, humid places and direct sunlight. Please avoid your refrigerator away from heat sources such as hobs, ovens, central heater and stoves.
5. There must be appropriate air ventilation around your refrigerator in order to achieve an efficient operation. The back of the appliance should be keep at least 100mm distance to a wall for ventilation purpose. Do not place your product on the materials such as rug or carpet.

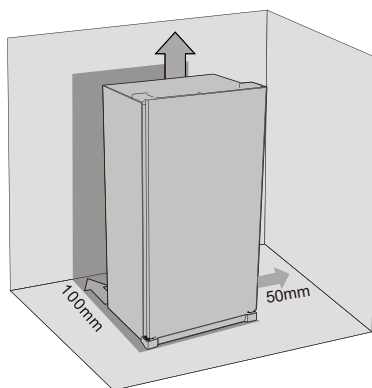

6. Allow the side of the appliance keep at least 50mm distance when installing and allow the door be open 135°

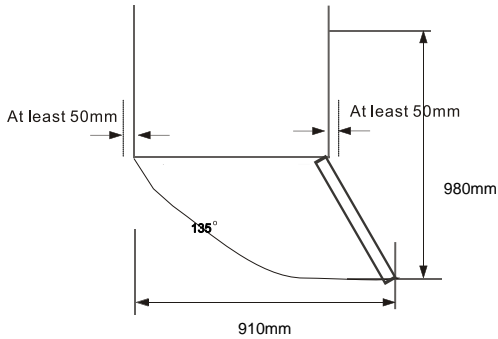

7. Please make sure the appliance levelling feet according to the installation condition, please adjust the feet to the suitable level. If the appliance not level, the doors and magnetic seal alignments will not be covered properly.

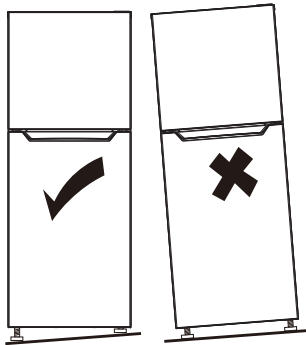

8. Wash the inside of the appliance with lukewarm water with a little bicarbonate of soda added (5ml to 0.5 litre of water). Do not use soap, detergent or any abrasive cleaner to wash. Dry the appliance thoroughly after cleaning.
9. Open the fridge door for ventilation of internal compartments. Idle for 4 hours before connecting the electrical mains to ensure the refrigerant in the compressor has settled well.
10. Connect the electrical mains and switch on the power for 4 hours initially before adding any goods. Make sure the ground is solid and will not vibrate when the appliance is operating.
11. If these temperatures are exceeded i.e., colder or warmer, the appliance will not operate correctly. Should the ambient temperatures be exceeded for long periods, the temperature in the freezer section will rise above $\leq -18^{\circ}\text{C}$ and food spoilage may occur.

3. PRODUCT DESCRIPTION

3.1 Overview

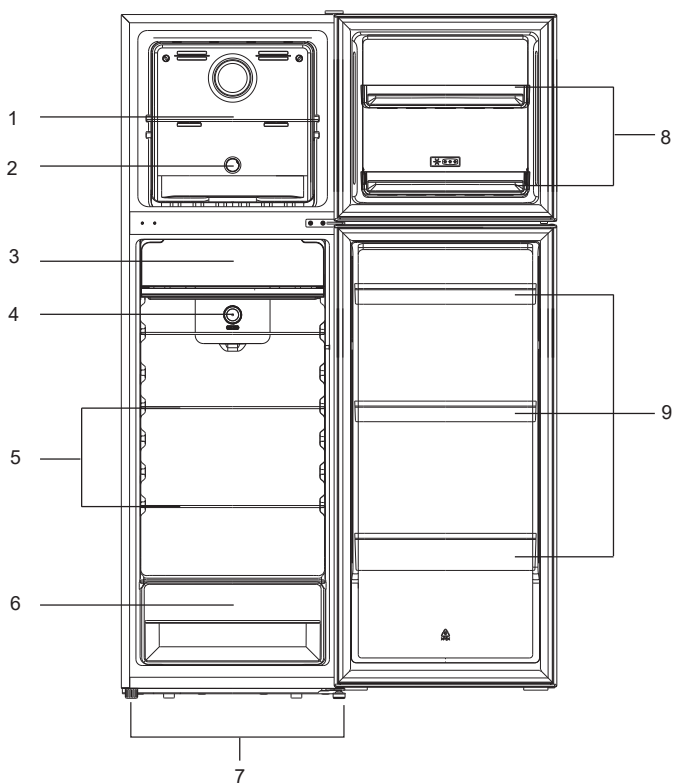

1. Tempered glass shelves
2. Freezer temperature control
3. Extra Chill+ Zone
4. Fridge temperature control
5. Tempered glass shelves
6. Nutri Fresh+ Zone
7. Level feet
8. Balcony / Rack
9. Balcony / Rack

* The above image is for reference purpose only. The actual appliance maybe slightly different.

3.2 Control Panel

3.2.1 Freezer Control Panel

The freezer thermostat control situated in the appliance regulates the temperature setting. The internal temperature is controlled by a sensor. There are 3 settings which is MIN, OPTIMAL and MAX. MIN is the warmest setting and MAX is the coldest setting. The coldest temperature is approximately $\leq -18^{\circ}\text{C}$. It's advisable to use the OPTIMAL setting to avoid the freezer in coldest temperature and it will reduce the life span of the compressor.



3.2.2 Fridge Control Panel

The fridge thermostat control situated in the appliance regulates the temperature setting. The internal temperature is controlled by a sensor. There are 4 settings which is OFF, MIN, OPTIMAL and MAX. MIN is the warmest setting and MAX is the coldest setting. Temperature is approximately between 8°Cto $\leq 1.5^{\circ}\text{C}$ according to each temperature setting. The appliance will be turn off completely if turn to "OFF". It's advisable to use the OPTIMAL setting to ensure the foods maintain at the best quality.



* The internal temperature will have a variance if the door open too often as warm air will enter into fridge and it's advisable to use the recommended setting to maintain the life span of the compressor.

3.3 Compartments Overview

Nutri Fresh+ Zone

Nutri fresh+zone is designed specially to keep the vegetables fresh without losing their humidity and maintain the freshness. For this purpose, cool air circulation is intensified around the nutri fresh+ zone in general. This compartment is the coolest place in the fridge to store the fruits and vegetables.

Humidity	Ideal goods
Low	Pears, apples, grapes, mushrooms, peppers, berries and etc.
High	Carrots, leafy greens, spinach, arugula, basil, broccoli and etc.

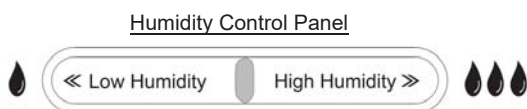

Low Humidity (Fruits): Turn the humidity level to left and let more cool air enter into fresh zone.

High Humidity (Vegetables): Turn the humidity level to right and let less cool air enter into fresh zone.

Extra Chill+ Zone

Use this compartment to store dairy products that shall be stored in a lower temperature that you will consume in a short time. This compartment is the slightly warmer than the nutri fresh+ zone where you can keep dairy products under ideal storage conditions. Fruits and vegetables should not be stored in this compartment.

Twist Ice Maker

Remove the ice container from the freezer compartment. Then fill the ice container with water. Place the ice container in the freezer compartment. About two hours later, the ice is ready to serve. Remove the ice container from the freezer compartment and bend it over the ice storage plate. Ice cubes will easily fall down to the ice storage plate.

Other Compartment

The below chart is the suggested foods to be stored in each compartment.

Compartment	Suggested Foods to place
Freezer Compartment Shelves	Various frozen food such as meat, fish, ice cream, prawn and etc.
Egg Tray	Egg
Fridge Compartment Shelves	Food in pans, covered plates and closed containers
Fridge Compartment Balcony / Rack	Small and packaged food or drinks(such as milk, fruit juice, jam and etc.)
Nutri Fresh+ Zone	Vegetables and fruits
Extra Chill+ Zone	Dairy products (cheese, butter and etc.)

4. DAILY TIPS

4.1 Freezing fresh food

- It is recommended to wrap or cover the food before placing them in the refrigerator.
- Hot food must cool down to the room temperature before putting them in the refrigerator.
- The food that you want to freeze must be fresh and in good quality.
- Food must be divided into portions according to the family's daily or meal based consumption needs.
- The food must be packaged in an airtight manner to prevent them from drying even if they are going to be kept for a short time.
- To minimize moisture loss, fruit and vegetables should be loosely enclosed in a plastic material. Example: wrap or bags without sealing and place in the moist fresh zone.
- Please observe the following instructions to obtain the best results.
 1. Do not freeze too large quantities of food at one time. The quality of the food is best preserved when it is frozen right through to the core as quickly as possible.
 2. Placing warm food into the freezer compartment causes the cooling system to operate continuously until the food is frozen solid.
 3. Do not block the outlet and inlet of the cool air circulating, otherwise the foods will not be evenly cooled throughout the refrigerator.
 4. Take special care not to mix already frozen food and fresh food.
 5. Keep the door securely closed.

4.2 Recommendations for preservation of frozen food

- Frozen food must be used immediately after they are thawed and they should never be re-frozen.
- To ensure that the high quality achieved by the frozen food manufacturer and the food retailer is maintained, the following should be remembered:
 1. Put packages in the freezer as quickly as possible after purchase.
 2. Ensure that contents are labelled and dated.
 3. Do not exceed "Best Before", "Use By" dates on the product packaging date.

4.3 Defrosting

The freezer compartment defrosts automatically

NOTE: If there is an electricity cut-off, please wait 10 minutes before operating the appliance again to avoid damage to the compressor.

5. CLEANING AND MAINTENANCE

1. Always ensure that the electrical main is turned off and unplugged before cleaning the appliance.
2. Remove the tempered glass shelf by lifting up and pull out slowly.

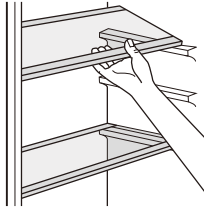

3. Remove each balcony / rack by lifting up and pull out slowly.

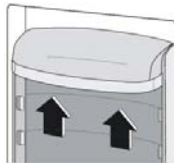

4. Wrap the food and keep them in a cool place.
5. Do not use chemical, steel, wooden or abrasive cleaners to clean the appliance.
6. Never use sharp instruments to scrape off frost or ice.
7. After cleaning, wipe the appliance until it is completely dry.
8. Use warm water to clean the oil and stains on the gasket in order to keep its elasticity.
9. This appliance should be serviced by an authorised service technician. Please contact the service centre if you required service on the appliance.
10. Under no circumstances should you attempt to repair the appliance by yourself.
11. Repairs carried out by inexperienced persons may cause injury or serious malfunctioning.

6. TROUBLESHOOTING

Failure	Failure Reason	Possible Solution
Appliance does not work	The plug is not plugged or is loose.	Plug in and turn on the power.
	The fuse on the plug has blown.	Change the fuse.
Appliance freezes or too cold	Temperature is set too cold.	Turn the temperature regulator to a warmer setting.
The food is not frozen enough	Temperature is not properly set.	Please refer to control panel page to set the correct temperature.
	Door is opening too regular.	Reduce the frequency to open the door.
	Large quantity of warm food was placed in the fridge within last 4 hours.	Turn the temperature to a colder setting for a temporary cool down.
	Directly under sunlight or too close to heat resources.	Do not install the appliance under direct sunlight.
Heavy build up of frost on the door seal	Door seal is not tight.	Please contact technician to replace a new door seal if necessary.
Unusual noises	Appliance is not level.	Readjust the feet.

7.0 MAIN SPECIFICATION

Model No	: ER-Q4357IN(GR)
Gross Capacity	: 430 Litres
Net Capacity	: 334 Litres
Climatic Type	: T
Insulation Class	: CLASS I
Total Input Power	: 140 W
Rated Voltage	: 220-240V / 50Hz
Rated Current	: 1.3 A
Refrigerant	: R600a (56g)
Product Dimension (mm):	605 (W) x 670(D) x 1705 (H)

NOTICE

This appliance must not be disposed together with domestic waste. It has to be disposed at an authorized place for recycling of electrical and electronic appliances. By collecting and recycling waste, you help to save natural resources and make sure the appliance is disposed in an environmental friendly and healthy way.



ELBA