

ELBA
Looks Good. Works Even Better.



THE WONDERS OF COOKING

COOKER HOOD & GLASS STOVE SERIES 2020

GLASS STOVES

ELBA Glass Stoves provide a premium touch to your kitchen while making your cooking experience a breeze. The usage of premium tempered glass gives it a smooth surface that is stylish and easy to clean while being sturdy and durable to overtime usage. Your cooking experience will be made even more effortless with a battery-powered ignition and high-performance mechanisms.

COMMON POINTS

- Easy-cleaning Glass Top
- Built-in or Countertop Dual Usage
- Front Control Panel for Easy Operation
- 4 Rubber Stands for Freestanding
- Easy-cleaning Stainless Steel Gravy Tray



EGH-J8552G(BK) **NEW**

- 2 Turbo Jet Burners (5.0kW)
- Ø120 x 120mm Brass Burner Rings and Caps
- High Quality Tempered Glass
- Automatic Battery Ignition
- Cast Iron Pan Support
- Enamel Wok Stand

Product Dimension (mm): 760(W) x 440(D) | Built-in Dimension (mm): 650 (W) x 350 (D)



EGH-G8522G(BK)

- 2 Triple Ring Burners (5.0kW)
- Ø128 x 128mm Brass Burner Rings and Caps
- Aluminium Burner Base
- High Quality Tempered Glass
- Automatic Battery Ignition
- Cast Iron Pan Support
- Cast Iron Wok Stand

Product Dimension (mm): 760(W) x 450(D)
Built-in Dimension (mm): 703(W) x 403(D)



EGH-G8523G(BK)

- 2 Triple Ring Burners (5.0kW)
- + 1 Auxiliary Burner (1.75kW)
- Ø128 x 128mm Brass Burner Rings and Caps
- Aluminium Burner Base
- High Quality Tempered Glass
- Automatic Battery Ignition
- Cast Iron Pan Support
- Cast Iron Wok Stand

Product Dimension (mm): 760(W) x 450(D)
Built-in Dimension (mm): 703(W) x 403(D)



EGH-F8582GX(BK)

- 2 Triple Ring Burners (4.8kW)
- Ø120 x 120mm Brass Burner Rings and Caps
- High Quality Tempered Glass
- Automatic Battery Ignition
- Cast Iron Pan Support
- Enamel Wok Stand

Product Dimension (mm): 760(W) x 440(D)
Built-in Dimension (mm): 650(W) x 350(D)



EGH-D8502GX(BK)

- 2 Triple Ring Burners (4.8kW)
- Ø100 x 100mm Brass Burner Rings and Caps
- Decorative Iron Rings
- High Quality Tempered Glass
- Automatic Battery Ignition
- Cast Iron Pan Support
- Enamel Wok Stand

Product Dimension (mm): 760(W) x 440(D)
Built-in Dimension (mm): 705(W) x 375(D)



EGH-D8503GX(BK)

- 2 Triple Ring Burners (4.8kW)
- + 1 Auxiliary Burner (1.75kW)
- Ø100 x 100mm Brass Burner Rings and Caps
- Decorative Iron Rings
- High Quality Tempered Glass
- Automatic Battery Ignition
- Cast Iron Pan Support
- Enamel Wok Stand

Product Dimension (mm): 760(W) x 440(D)
Built-in Dimension (mm): 705(W) x 375(D)

COOKER HOOD

A well-functioning a kitchen is one that has an efficient ventilation system. The high-performance filtration system and an oil cup that is built into ELBA Cooker Hoods ensure there is no room for steam, odour, smoke and grease to escape. With a slim shape and LED lights equipped, your kitchen will be blessed with a delicate ambience while you are preparing your favourite dishes.

INFINITO EH-J9088(SS) **NEW**

Available in: ● Stainless Steel

- Suction Power (m³/hr): 1,400
- With 3-speeds Fan Control
- With Charcoal Filter
- LED Lamp
- Washable Pyramidal Shaped Filter with Oil Cup
- Premium Stainless Steel Chassis
- Push Button Control

Product Dimension (mm): 895(W) x 549-1,029(H) x 500(D)



SLIM HOODS

COMMON POINTS

- 2 x 1.5W LED Lights
- Detachable Fan Guards for Easy Cleaning
- Easy-cleaning Oil Cups to Capture Grease (2 Sets)

- Slim & Smooth Design to Complement Any Kitchen Size
- Push Button Function Key
- Convenient Ductless Range Hood



ESH-J7695(BK/SS) **NEW**

Available in: ● Black ● Stainless Steel

- Suction Power (m³/hr): 900
- Speed Range (rpm): 1,100
- Twin Motors & Twin Blowers
- Elongated Oil Cup
- Venting Type: Updraft

Product Dimension (mm): 750(W) x 120(H) x 510(D)



ESH-J9095(BK/SS) **NEW**

Available in: ● Black ● Stainless Steel

- Suction Power (m³/hr): 900
- Speed Range (rpm): 1,100
- Twin Motors & Twin Blowers
- Elongated Oil Cup
- Venting Type: Updraft

Product Dimension (mm): 895(W) x 120(H) x 510(D)

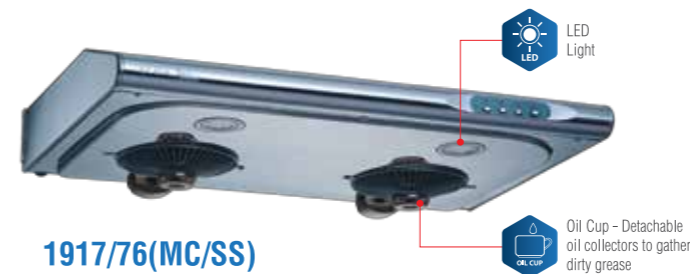

1917/76(MC/SS)

Available in: ● Mocha ● Stainless Steel

- Suction Power (m³/hr): 885
- Speed Range (rpm): 1,430
- Twin Motors & Twin Blowers
- Charcoal Filter Type: Round Type
- Venting Type: Updraft
- Independent Control of Blowers

Product Dimension (mm): 755(W) x 100(H) x 510(D)



2918/90(MC/SS)

Available in: ● Mocha ● Stainless Steel

- Suction Power (m³/hr): 885
- Speed Range (rpm): 1,430
- Twin Motors & Twin Blowers
- Charcoal Filter Type: Round Type
- Venting Type: Updraft
- Independent Control of Blowers

Product Dimension (mm): 895(W) x 100(H) x 530(D)

PRODUCT DIMENSION

GLASS STOVES

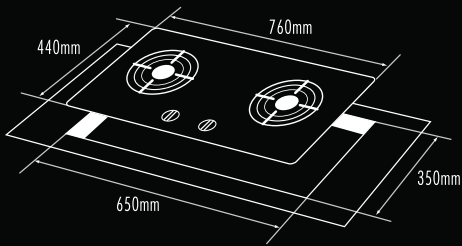

EGH-J8552G(BK)

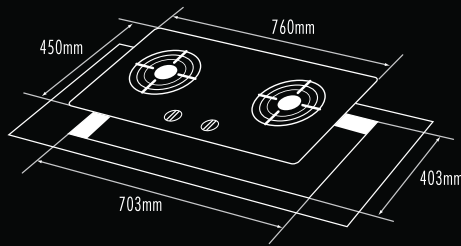

EGH-G8522G(BK)

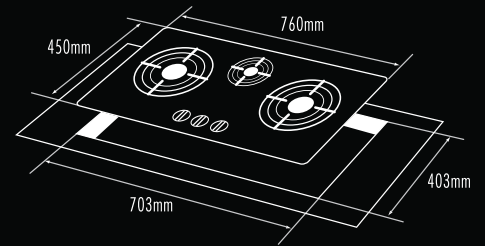

EGH-G8523G(BK)

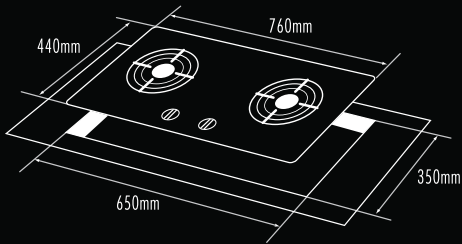

EGH-F8582GX(BK)

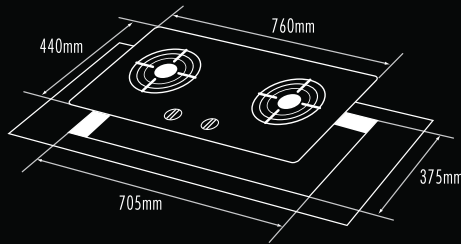

EGH-D8502XG(BK)

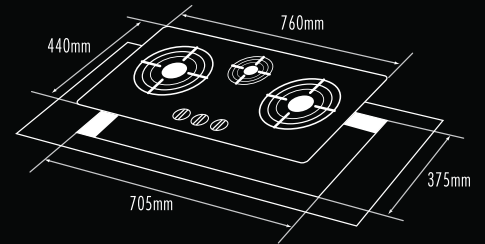

EGH-D8503GX(BK)

COOKER HOOD

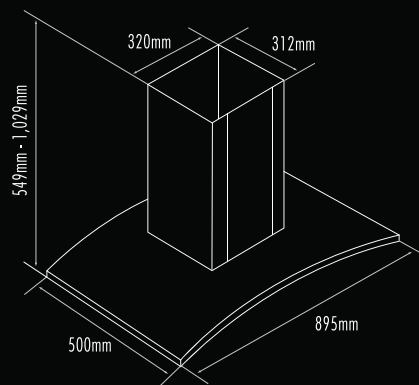

INFINITO EH-J9088(SS)

SLIM HOODS

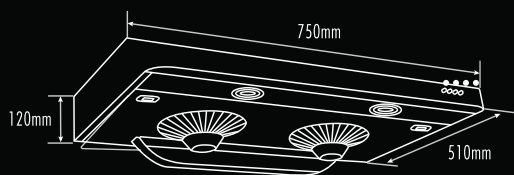

ESH-J7695(BK/SS)

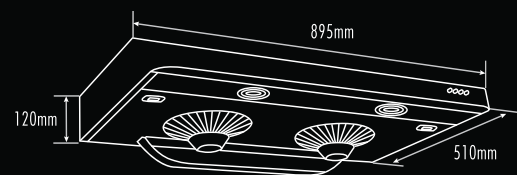

ESH-J9095(BK/SS)

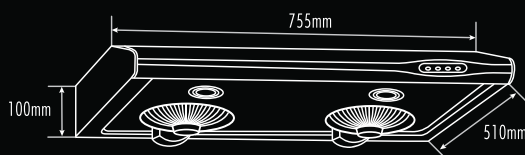

1917/76 (MC/SS)

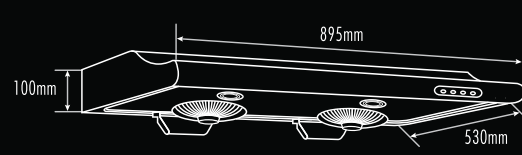

2918/90 (MC/SS)

* All models, specifications and availability are correct at the time of printing and subject to change without prior notice.

* Visuals are for illustration purposes only. Actual items may vary or differ from the visuals shown here.



FIAMMA SDN.BHD. (47268-M)
Wisma Fiamma, No.20, Jalan 7A/62A,
Bandar Manjalara, 52200 Kuala Lumpur.
Tel : 03-6279 8888 Fax : 03-6279 8846

www.elba.com.my

ELBAMalaysia

AFTER-SALES SERVICE
03-6286 9000

Discover ELBA here.

Scan the QR code on
your smartphone for
more information.

