

ELBA

DISHWASHER

MODEL: EDW-M1331D(WH)

Owner's Manual

Please read this manual carefully before operating your set.

Retain it for future reference.

Record model number and serial number of the set.

See the label attached on the set and quote this information to your dealer when you require service.

For The Warranty Terms & Conditions, Please Refer To Warranty Certificate

CONTENTS

1. SAFETY PRECAUTIONS.....	1-3
2. INSTALLATION.....	4-5
3. PRODUCT OVERVIEW.....	6
4. BEFORE USING THE APPLIANCE.....	7-10
5. LOADING YOUR DISWASHER.....	11-13
5.1 ALTERNATIVE BASKET LOADS.....	14-15
6. CONTROL PANEL DESCRIPTIONS.....	15-17
6.1 CHANGING A PROGRAM.....	17-18
6.2 CANCELLING A PROGRAM.....	18
6.3 SWITCHING THE MACHINE OFF.....	18
7. PROGRAM TABLE.....	19
8. CLEANING AND MAINTENANCE.....	20-21
9. TROUBLESHOOTING.....	22
10.ERROR CODE.....	23
11.TECHNICAL SPECIFICATION.....	24

REMOVE ALL PACKING MATERIALS FROM THIS PRODUCT BEFORE USING IT. THIS APPLIANCE MUST BE INSTALLED IN LEVEL. PLEASE ENSURE THE ELECTRICITY SUPPLY TO THIS APPLIANCE IS DISCONNECTED BEFORE INSTALLING.

Please read this instruction carefully. It is advisable to keep this instruction manual in a safe place for future reference.

1. SAFETY PRECAUTIONS

1. Keep this appliance out of reach from children. Do not let them to operate the appliance without supervision.
2. Check the current rating on the rating plate and make sure the current supplied is matched with the appliance before using.
3. This product is for household and indoor use only.
4. This product is not intended for use by person (including children) with reduced physical, sensory or mental capabilities unless they have been given supervision or instruction concerning use of the appliance by a person responsible for their safety.
5. If the power cord or plug is damaged, it must be replaced by the service centre or a qualified service technician to avoid hazard.
6. Any electrical work required to install this appliance should be carried out by a qualified technician or competent personnel.

WARNING - to reduce the risk of fire or injury to persons or property, please read and follow below instructions carefully:

- Do not operate this appliance if it has malfunctioned, damaged or appears damaged in any way. Make enquiry to our service centre and return the complete set to the place of purchase for inspection, repair or replacement.
- This appliance must be grounded and the ground wire should not be connected to any heating pipe and gas pipe.
- The plug must be plugged into an appropriate outlet that is installed and grounded in accordance with all local codes and ordinances.
- Do not abuse, sit or stand on the door or dish rack of the unit.
- Do not operate the appliance unless all enclosure panels are properly in place. Open the door carefully if the appliance is operating, there will be risk of water squirting out.
- Do not place heavy objects or stand on the appliance door when it is open.

INSTALLATION WARNINGS

- Choose a suitable and safe place to install your machine.
- Only original spare parts should be used with the machine.

 Unplug the machine before installation.

 Your machine must only be installed by an authorised service agent. Installation by anyone other than an authorised agent may cause your warranty to be void.

 Check that the indoor electrical fuse system is connected in line with safety regulations.

 All electrical connections must match the values on the plate.

 Ensure the machine does not stand on the electrical supply cable.

 Never use an extension cord or a multiple socket connection.

 The plug should be accessible after the machine is installed.

- After installation, run your machine unloaded for the first time.

 The machine must not be plugged in during positioning.

 Always use the coated plug supplied with your machine.

 If the electrical cable is damaged, it should only be replaced by a qualified electrician.

- Connect the hose directly to the water inlet tap. The pressure supplied by the tap should be a minimum of 0.03 MPa and a maximum of 1 MPa. If the pressure exceeds 1 MPa, a pressure relief valve must be fitted between the connection.

DURING USAGE

- This machine is for domestic use only; do not use it for other purposes. Commercial use will void the guarantee.

 Do not stand, sit or place loads on the open door of the dishwasher.

 Only use detergents and rinse aids produced specifically for dishwashers. Our company is not responsible for any damage that may occur due to misuse.

 Do not drink water from the machine.

 Due to the danger of explosion, do not place any chemical dissolving agents into the machine's washing section.

- Check the heat-resistance of plastic items before washing them in the machine.

 Only put items in the machine which are suitable for dishwashing, and take care not to overfill the baskets.

 Do not open the door while the machine is in operation, hot water may spill out. Safety devices ensure the machine stops if the door is opened.

 The machine door should not be left open. It may cause accidents.

 Place knives and other sharp objects in the cutlery basket in a blade-down position.

 For models with the automatic door-opening system, when the Energy Save option is active, the door will open at the end of a program. To prevent damage to your dishwasher, do not attempt to close the door for one minute after it has opened. For effective drying, keep the door open for 30 minutes after a programme has ended. Do not stand in front of the door after the auto-open signal sounds.

 In the case of a malfunction, repair should only be performed by an authorised service company, otherwise the warranty will be void.

 Before repair work, the machine should be disconnected from the mains. Do not pull the cable to unplug the machine. Switch off the water tap.

 Operation at a low voltage will cause a decline in performance levels.

 For safety, disconnect the plug once a program has finished.

 To avoid an electric shock, do not unplug the machine with wet hands.

 Pull the plug to disconnect the machine from the mains, never pull on the cord.

RECYCLING

- Some machine components and packaging consist of recyclable materials.
- Plastics are marked with the international abbreviations:(>PE<, >PP<, etc.)
- The cardboard parts consist of recycled paper. They can be put into waste paper containers for recycling.
- Material unsuitable for domestic waste must be disposed of at recycling centres.
- Contact a relevant recycling centre to obtain information about disposal of different materials.

PACKAGING AND THE ENVIRONMENT

- Packaging materials protect your machine from damage that may occur during transportation. The packaging materials are environmentally friendly as they are recyclable. The use of recycled material reduces raw material consumption and therefore decreases waste production.

DISPOSAL OF YOUR OLD MACHINE



The symbol on the product or on its packaging indicates that this product may not be treated as household waste. Instead, it shall be handed over to the applicable collection point for the recycling of electrical and electronic equipment. By ensuring this product is disposed of correctly, you will help prevent potential negative consequences for the environment and human health, which could otherwise be caused by inappropriate waste handling of this product. For more detailed information about recycling of this product, please contact your local city office, your household waste disposal service or the shop where the product was purchased.

2. INSTALLATION

MACHINE POSITIONING

- When positioning the machine, place it in an area where dishes can be easily loaded and unloaded. Do not put the machine in an area where the ambient temperature falls below 0°C.
- Read all warnings located on the packaging before removing the packaging and positioning the machine.
- Place the machine close to a water tap and drain. Take into consideration that the connections will not be altered once the machine is in position.
- Do not hold the machine by its door or panel.
- Leave an adequate distance around the machine to allow ease of movement when cleaning.

 **Ensure the water inlet and outlet hoses are not squeezed or trapped and that the machine does not stand on the electrical cable while positioning.**

- Adjust the feet so the machine is level and balanced. The machine should be placed on flat ground otherwise it will be unstable and the door of the machine will not close properly.

WATER CONNECTION

We recommend fitting a filter to your water inlet supply in order to prevent damage to your machine due to contamination (sand, rust, etc.) from indoor plumbing. This will also help prevent yellowing and deposit formation after washing.

NOTE: Cold water preferred; hot water max. temperature 60 °C.

WATER INLET HOSE

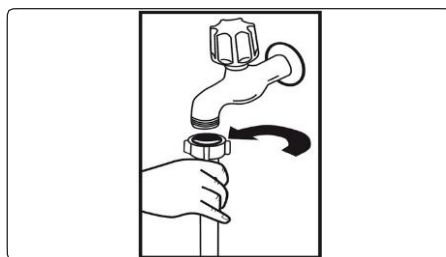

 **WARNING:** Use the new water inlet hose supplied with your machine, do not use an old machine's hose.

 **WARNING:** Run water through the new hose before connecting.

 **WARNING:** Connect the hose directly to the water inlet tap. The pressure supplied by the tap should be a minimum of 0.03 MPa and a maximum of 1 MPa. If the pressure exceeds 1 MPa, a pressure relief valve must be fitted between the connection.

 **WARNING:** After the connections are made, turn the tap on fully and check for water leaks. Always turn off the water inlet tap after a wash program has finished.

DRAIN HOSE

Connect the water drain hose directly to water drain hole or to the sink outlet spigot. This connection should be minimum 50 cm and maximum 110 cm from floor.

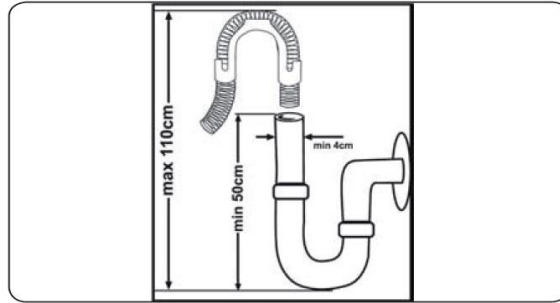

IMPORTANT: Items will not wash properly if a drain hose longer than 4m is used.

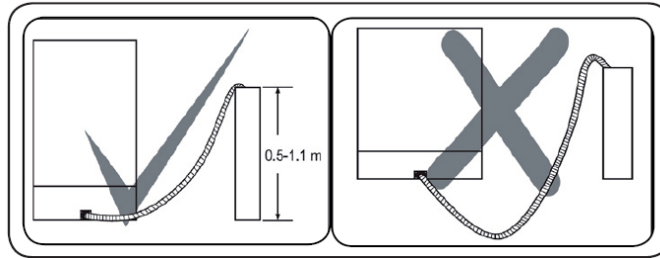

ELECTRICAL CONNECTIONS

! WARNING: Your machine is set to operate at 220-240 V~.

! Connect the product to a grounded outlet protected by a fuse complying with the values in the "Technical Specifications" table (PAGE 24).

! The earthed plug of the machine must be connected to an earthed outlet supplied by suitable voltage and current.

! In the absence of earthing installation, an authorised electrician should carry out an earthing installation. In the case of use without earthing installed, we will not be responsible for any loss of use that may occur.

! The plug on this appliance is incorporate 13A fuse.

3. PRODUCT OVERVIEW

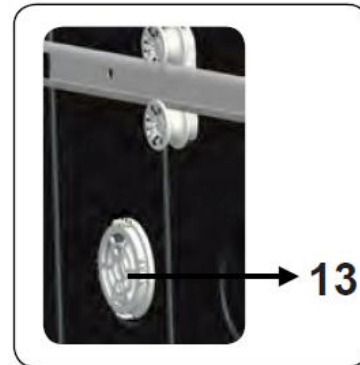
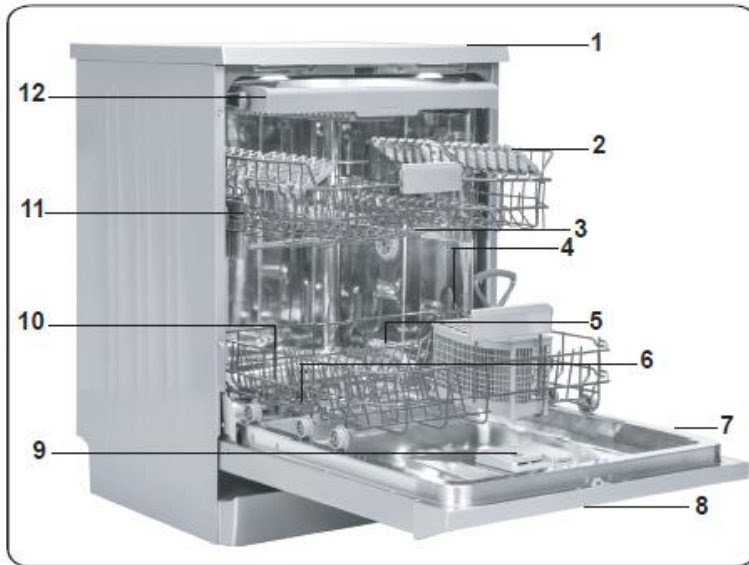

1. Top panel
2. Upper basket
3. Upper spray arm
4. Lower basket
5. Lower spray arm
6. Metal Filters
7. Rating plate
8. Control panel
9. Detergent and rinse-aid dispenser
10. Salt dispenser
11. Upper Basket Track Latch
12. Upper Cutlery Basket (Third Rack)
13. Active Drying Unit: This system provides better drying performance.

4. BEFORE USING THE APPLIANCE

Preparing your dishwasher for first use

- Make sure the electricity and supply water specifications match the values indicated in the installation instructions for the machine.
- Remove all packaging material inside the machine.
- Set the water softener level.
- Fill the rinse aid compartment.

Salt usage (If Available)

For a good washing function, the dishwasher needs soft, i.e. less calcareous water. Otherwise, White lime residues will remain on the dishes and the interior equipment. This will negatively affect your machine's washing, drying and shining performance. When water flows through the softener system, the ions forming the hardness are removed from the water and the water reaches the softness required to obtain the best washing result. Depending on the level of hardness of the inflowing water, these ions that harden the water accumulate rapidly inside the softener system. Therefore, the softener system has to be refreshed so that it operates with the same performance also during the next wash. For this purpose, dishwasher salt is used.

Machine can only be used by special dishwasher salt to soften the water. Do not use any small grained or powdered type of salts which can easily soluble. Using any other type of salt can damage your machine.

Fill the salt (If Available)

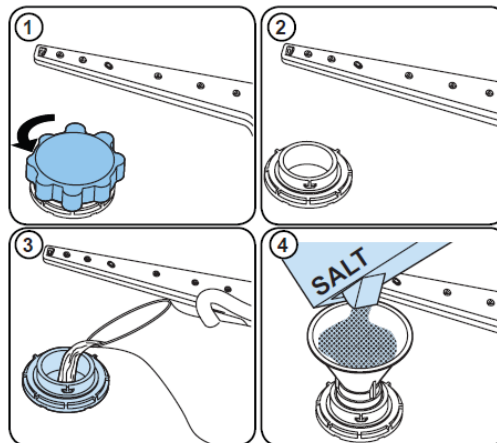

- Step 1 & 2: To add softener salt, open the salt compartment cap by turning it counter clockwise.
- Step 3: At first use, fill the compartment with 1 kg salt and water until it is almost overflowing.

If available, using a funnel will make filling easier. Replace the cap and close it. After every 20-30 Cycles add salt into your machine until it fills up (approx. 1 kg).

Only add water to the salt compartment on first use.

- Use softener salt specifically produced for use in dishwashers.
- When you start your dishwasher, the salt compartment is filled with water, therefore put the softener salt in prior to starting your machine.
- If the softener salt has overflowed and you do not start the machine immediately, run a short washing program to protect your machine against corrosion.

Test Strip

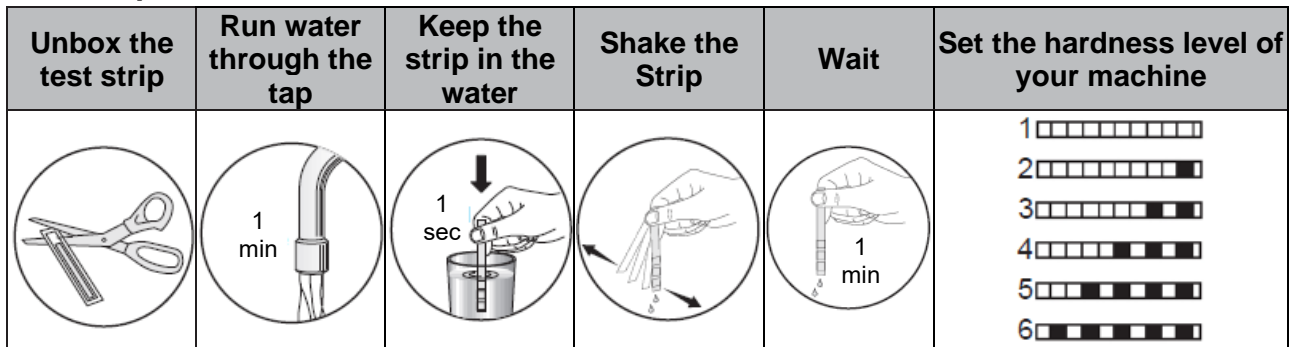

NOTE: The level is set to 3 as default. If the water is well water or has a hardness level above 90 dF, we recommend that you use filter and refinement devices.

Water Hardness Table



Level	German dH	French dF	British dE	Indicator
1	0-5	0-9	0-6	L1 is seen on the display.
2	6-11	10-20	7-14	L2 is seen on the display.
3	12-17	21-30	15-21	L3 is seen on the display.
4	18-22	31-40	22-28	L4 is seen on the display.
5	23-31	41-55	29-39	L5 is seen on the display.
6	32-50	56-90	40-63	L6 is seen on the display.

Water Softener System

The dishwasher is equipped with a water softener which reduces the hardness in the mains water supply. To find out the hardness level of your tap water, please use the test strip (if available).

Setting

- Turn on the machine by pressing the On/Off button “⏻”.
- Press the Program button “⏸” for at least 3 seconds immediately after the machine is turned on.
- Release the Program button “⏸” when “SL” is shown. Next, the last setting level is displayed.

- Press the program button “” to set the desired level. Each press of the program button increases the level. Once level 6 has been reached, the next press returns the level to 1.
- The last selected water hardness level is stored in the memory by turning the machine off with the On/Off button “”.

Detergent usage

Only use detergents specifically designed for domestic dishwashers. Keep your detergents in cool, dry places out of reach of children.

- Add the proper detergent for the selected program to ensure the best performance. The amount of detergent needed depends on the cycle, load size, and soil level of dishes.
- Do not fill detergent into the detergent compartment more than required; otherwise you can see whitish streaks or bluish layers on glass and dishes and may cause glass corrosion. Continued use of too much detergent may cause machine damage.
- Using little detergent can result in poor cleaning and you can see whitish streak in hard water.

NOTE: See the detergent manufacturer’s instructions for a further information.

Filling the detergent

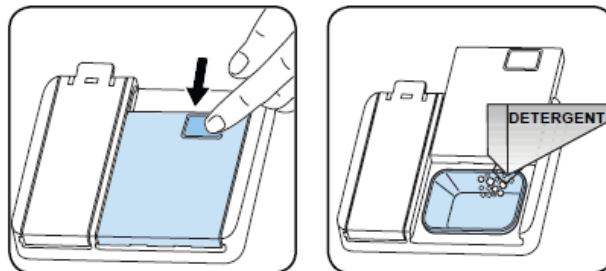

- Push the latch to open the dispenser and pour in the detergent.
- Close the lid and press it until it locks in place. The dispenser should be refilled just before the start of each programme. If the dishes are heavily soiled, place additional detergent in the pre-wash detergent chamber.

Using combined detergents

- These products should be used according to the manufacturer’s instructions.
- Never put combined detergents into the interior section or the cutlery basket. Combined detergents contain not only the detergent but also rinse-aid, salt replacement substances and additional components depending on the combination.
- We recommend you do not use combined detergents in short programmes. Please use powder detergents instead. If you encounter problems when using combined detergents, please contact the detergent manufacturer.
- When you stop using combined detergents, make sure that water hardness and rinse aid settings are set to the correct level.

Rinse-aid usage

- The rinse aid helps to dry the dishes without streaks and stains. Rinse-aid is required for stain-free utensils and clear glasses. The rinse aid is automatically released during the hot rinse phase.
- If rinse aid dosage setting set too low, whitish stains remains on dishes and dishes do not dry and washed clean.
- If rinse aid dosage setting set too height, you can see bluish layers on glass and dishes.

Filling the rinse-aid and setting

To fill the rinse aid compartment, open the rinse-aid compartment cap. Fill the compartment with rinse aid to the **MAX** level and then close the cap. Be careful not to overfill the rinse aid compartment and wipe up any spills.

In order to change the rinse aid level, follow the below steps before turning on the machine:

- Push the programme button “⏏” and hold it down.
- Turn the machine on “⏻”. Hold down the programme button until “rA” disappears from the display. Rinse aid setting follows water hardness setting.
- The machine will display the last setting. Set the level by pushing the programme button “⏏”.
- Switch off “⏻” the machine to save the setting.
- The factory setting is “4”. If the dishes are not drying properly or are spotted, increase the level. If blue stains form on your dishes, decrease the level.

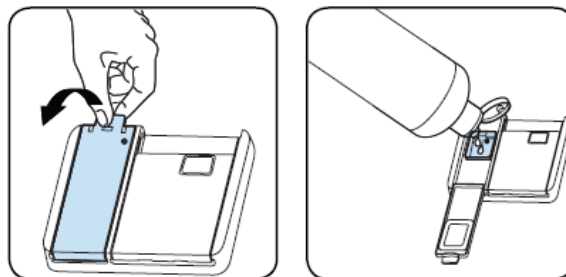

Level	Brightener Dose	Indicator
1	Rinse-aid not dispensed	r1 is shown on the display.
2	1 dose is dispensed	r2 is shown on the display.
3	2 doses are dispensed	r3 is shown on the display.
4	3 doses are dispensed	r4 is shown on the display.
5	4 doses are dispensed	r5 is shown on the display.

5. LOADING YOUR DISHWASHER

For best results, follow these loading guidelines.

Loading the household dishwasher up to the capacity indicated by the manufacturer will contribute to energy and water savings.

Manual pre-rinsing of tableware items leads to increased water and energy consumption and is not recommended. You can place cups, glasses, stemware, small plates, bowls, etc. in upper basket. Do not lean long glasses against one another or they cannot remain steady and may receive damage.

When placing long stem glasses and goblets, lean them against the basket edge or rack and not against other items.

Place all containers such as cups, glasses and pots into the dishwasher with the opening facing downwards otherwise water can collect on items. If there is cutlery basket in machine, you are recommended to use the cutlery grid in order to obtain the best result. Place all large (pots, pans, lids, plates, bowls etc.) and very dirty items in the lower rack. Dishes and cutlery should not be placed above each other.

 **WARNING:** Take care not to obstruct the rotation of spray arms.

 **WARNING:** Make sure after loading the dishes do not prevent opening the detergent dispenser.

Recommendations

Remove any coarse residue on dishes before placing the dishes in the machine. Start the machine with full load.

 Do not overload the drawers or place dishes in the wrong basket.

 **WARNING:** To avoid any possible injuries, place long-handle and sharp-pointed knives with their sharp points facing down or horizontally on the baskets.

Upper Basket

1. Height adjustment

Turn the Rail Stop Clips, at the ends of the rails, to the sides to open them (as shown in the image below), then pull out and remove the basket. Change the position of the wheels, then reinstall the basket to the rail, making sure to close the Rail Stop Clips. When the upper basket is in the higher position, large items such as pans can be placed on the lower basket.

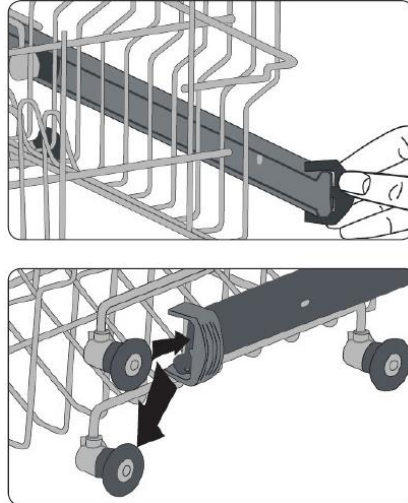

2. Height Adjustable Rack (Mug Shelf)

The height adjustable racks enable glasses and cups to be placed on or under the racks. The racks can be adjusted to 2 different heights. Cutlery and utensils can also be placed on the racks horizontally.

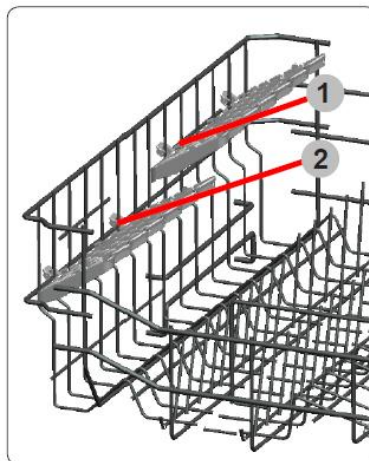

3. Height Adjustable Rack

The foldable racks in the upper basket enable the placement of large items such as pots and pans. Each section can be folded separately. The foldable racks can be either raised up or folded down.

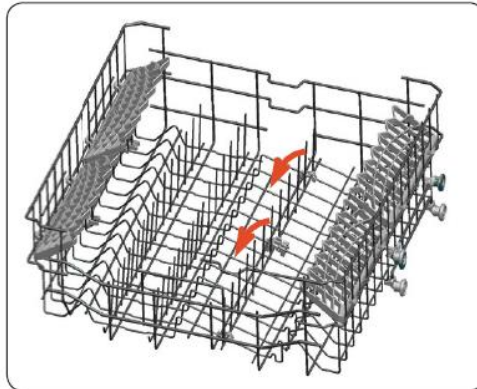

4. Lower Basket Two Folding Racks

The folding racks on the lower basket allow for the placement of larger items, such as pots and pans. Each section can be folded separately. They can either be folded down or raised up, as shown in the images below.

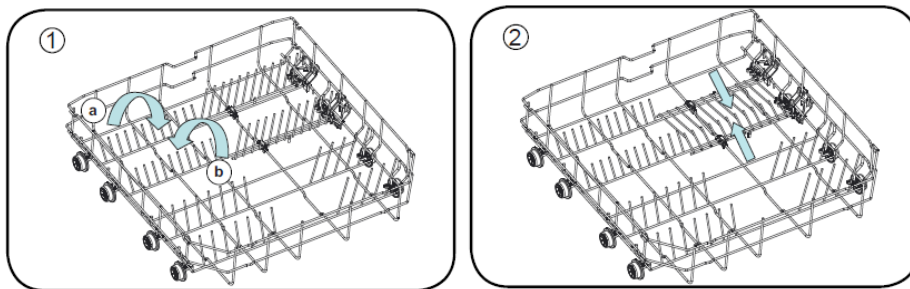

5. Upper Cutlery Basket (Third Rack)

The upper cutlery basket is designed for the placement of large and small cutlery and utensils.

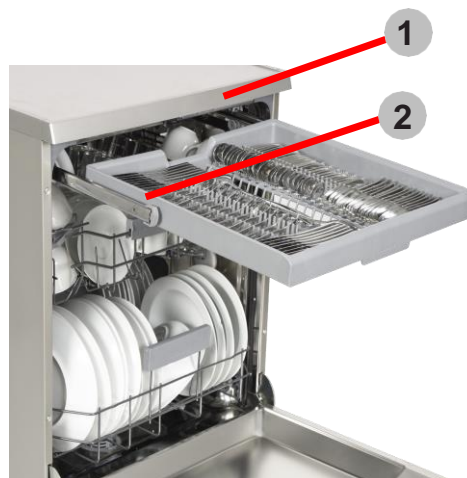

! **WARNING:** Knives and other sharp objects must be placed horizontally in the cutlery basket.

5.1 ALTERNATIVE BASKET LOADS:

LOWER BASKET

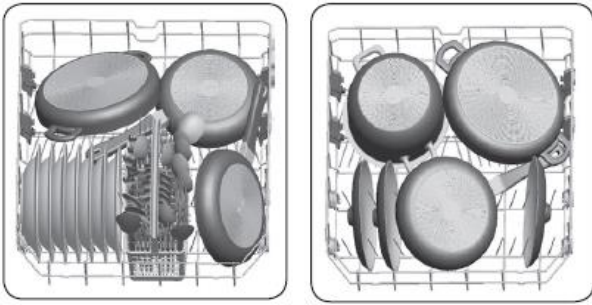

UPPER BASKET

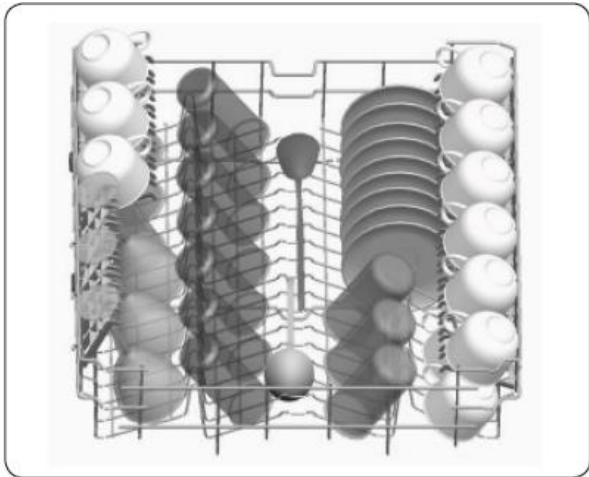

INCORRECT LOADS

Incorrect loading can cause poor washing and drying performance. Please follow the recommendations for a good performance result.

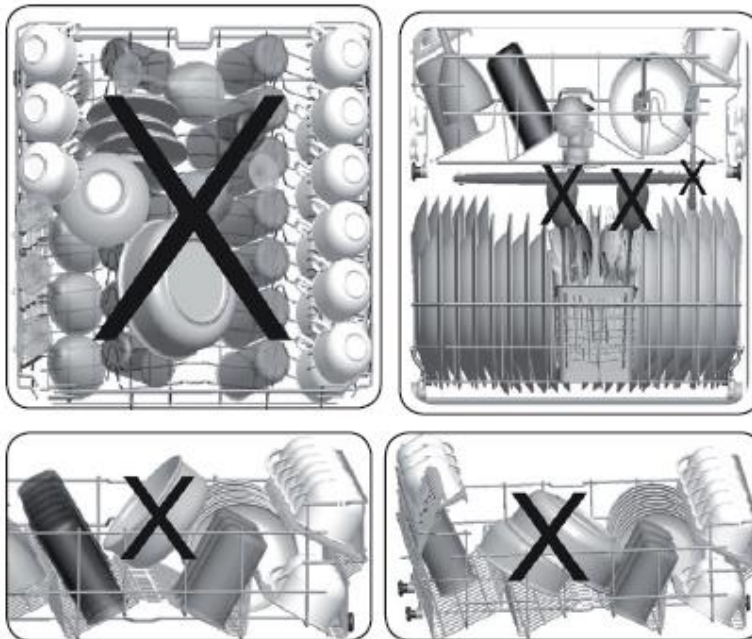

Unsuitable items for dishwashing

- Cigarette ashes, candle leftovers, polish, paint, chemical substances, iron-alloy materials.
- Forks, spoons and knives with wooden, bone, ivory or nacre coated handles; glued items, items soiled with abrasive, acidic or base chemicals. Temperature-sensitive plastics, copper or tin coated containers.
- Aluminium and silver objects.
Some delicate glasses, ornamental printed porcelains; some crystal items, adhered cutlery, lead crystal glasses, cutting boards, synthetic fibres items.
- Absorbent items such as sponges or kitchen rugs.

🚫 IMPORTANT: Purchase dishwasher-proof kitchenware.

6. CONTROL PANEL DESCRIPTIONS

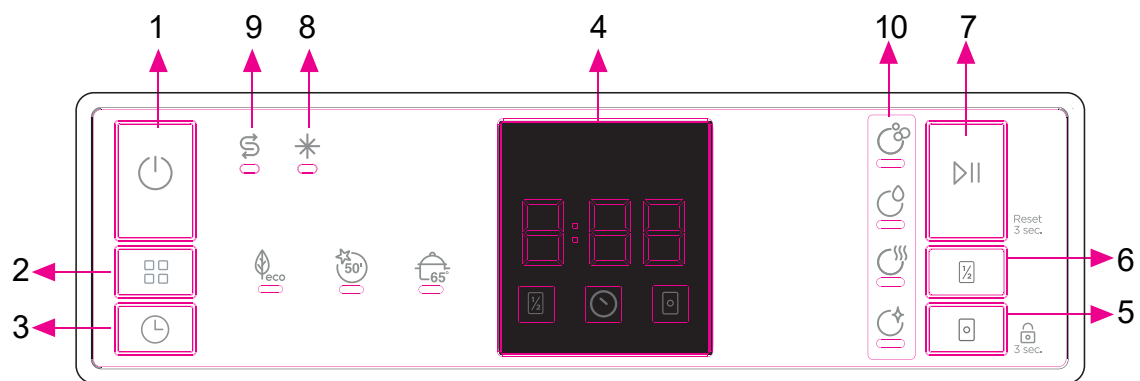

1. On/Off button
2. Program Selection Button
3. Delay Start Button
4. Remaining Time Indicator
5. Tablet Button
6. Half Load Quick Wash Button
7. Start/Pause Button
8. Rinse Aid Indicator
9. Salt Indicator
10. Washing Indicators
 - a. Washing Indicator
 - b. Rinse Indicator
 - c. Drying Indicator
 - d. End Indicator

On/Off Button

Switch the machine on by pressing the On/Off button “⏻”. The On/Off “⏻” indicator lights as long as the machine is on. If any button is not pressed, the machine turns off automatically after 15 minutes.

Program Selection Button

Select a suitable program by pressing Program Selection button “⏏”.

Delay Start Button

You can delay the start time of the program for 1-2...9 hours by pressing the Delay button “⌚” before the program starts. To activate the delay time, press Start/Pause button “▶||”. If you want to change the delay time, first press the Start/Pause button “▶||” and then the delay button to select a new delay time. To activate the new delay time, press the Start/Pause button “▶||” again. To cancel the delay, you need to switch to 0 hour by pressing the Delay button “⌚”.

If you switch off the machine after selecting and activating the delay time, the delayed time is cancelled.

Remaining Time Indicator

Program flow can be monitored via the Wash ⏻, Rinse ⏻, Dry ⏻, End ⏻ indicator and remaining time indicator. While the Dry ⏻ indicator is on, the machine remains silent for about 40-50 minutes with respect to the flow of the program you have selected.

Tablet Button

Press the Tablet button “⏏” to activate the Tablet when using combined detergent that contains salt and rinse aid.

Half Load Quick Wash Button

With Half load Quick Wash “½” function, you can shorten the durations of the programmes that you have selected and reduce the energy and water consumption by using half load electricity and water.

Start/Pause Button

Press the Start/Pause button “▶||” to start the selected program. The wash indicator turns on and the remaining time indicator shows the program duration. It also indicates the remaining time during the program flow. If you open the door of your machine when the program is running the duration of the program pauses, and the Start/Pause “▶||” indicator blinks.

Rinse Aid Indicator

When the rinse aid level is low, the rinse aid lack warning indicator “*” turns on and you should fill the rinse aid chamber.



Salt Indicator





When there is insufficient softening salt, the salt lack warning indicator “S” turns on and you should fill up the salt chamber.

Washing Indicators

You can monitor the program flow with the Washing Indicators on the control panel.

- Wash 
- Rinse 
- Dry 
- End 

 **NOTE:** Child lock “” is activated/deactivated by pressing the Tablet button “” for about 3 seconds. When it is activated, all indicator blink and “CL” is shown on the remaining time indicator once. When it is deactivated, all indicator and “CL” blink twice.

 **NOTE:** If you have used an extra feature on the latest washing program, this feature will remain active also on the next washing program. If you want to cancel this feature on the newly selected washing program, press the Half load “”, Tablet “” or Delay “” buttons until the related indicators are off or turn the machine off with the On/Off button “” if any washing program is not running. Otherwise, if the machine is running for a washing program, it is primarily paused and the cancellation is performed as explained above.

6.1 Changing a Program

If you would like to change the program when the machine is already running.

1. Press the Start/Pause button “”.

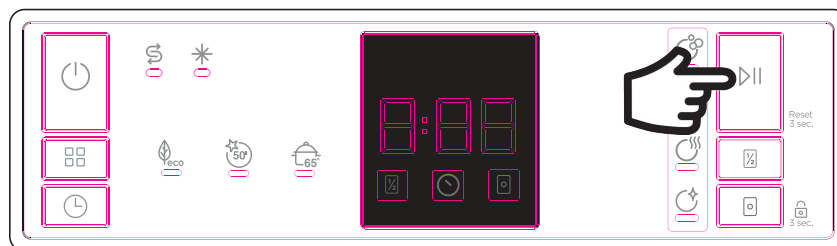

2. After the program stops, select your desired program by pressing Program Selection button “”.

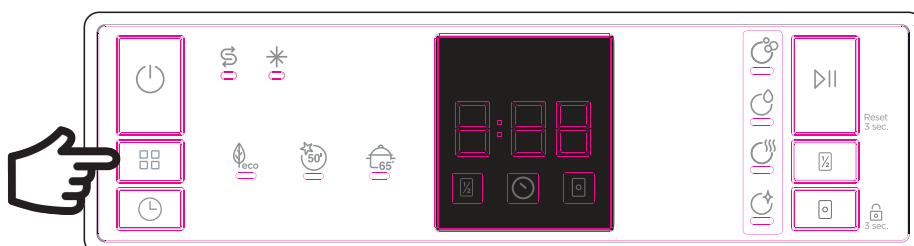

3. Start newly selected program by pressing the Start/Pause button “▶||”. The new program will resume the course of the old program.

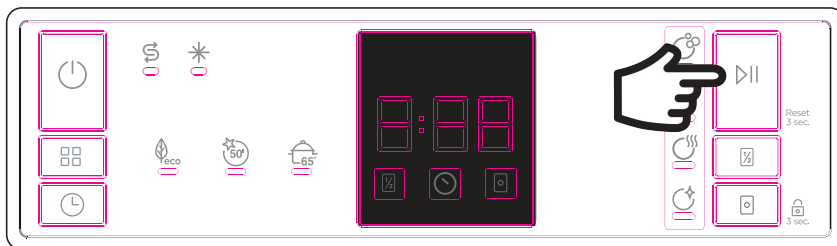

6.2 Cancelling a Program

If you would like to cancel a program when it is running.

1. Press the Start/Pause button “▶||” for 3 seconds.

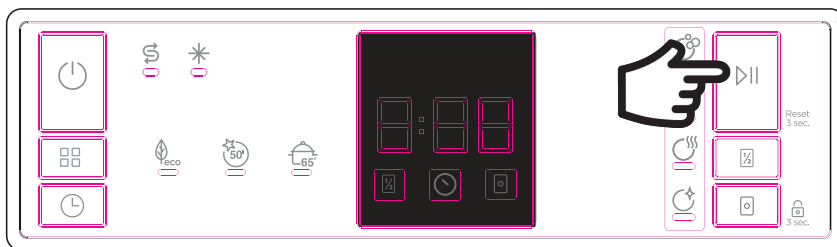

2. When the End led turns on, switch your machine off by pressing the On/Off button “⏻”.

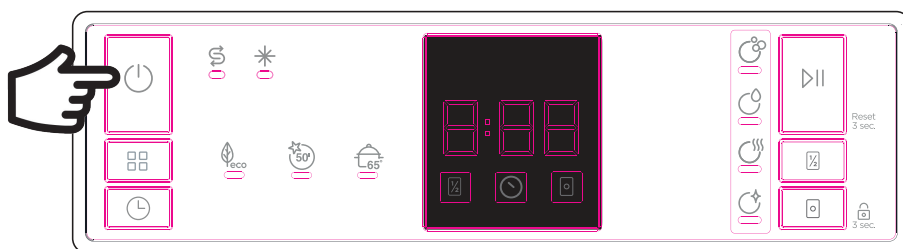

6.3 Switching the Machine Off

Switch your machine off with On/Off button “⏻” after the program has ended and the End led turns on.

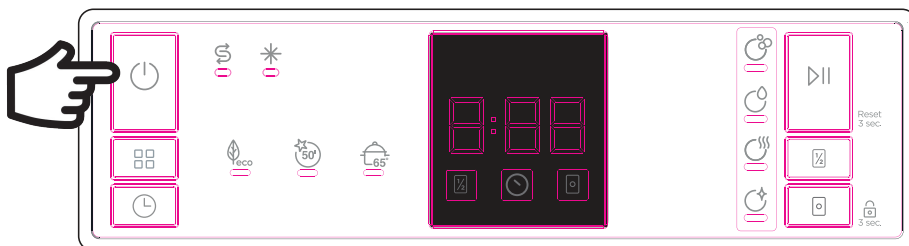

- ⓘ **NOTE:** Do not open the door before the program ends.
- ⓘ **NOTE:** At the end of the washing program, you can leave the door of your machine to open for drying
- ⓘ **NOTE:** If the door of the machine is opened or power is cut off during washing, the program will continue when the door is closed or the power is restored.

7. PROGRAM TABLE

	Program 1	Program 2	Program 3
Program	Smart Eco	Super 50'	Intensive 65°C
Type of Soil:	Standard program for normally soiled daily using dishes with reduced energy and water consumptions.	Suitable for normally soiled daily dishes with faster program.	Suitable for heavily soiled dishes.
Level of Soil:	Medium	Medium	Heavy
Amount of Detergent: A: 25 cm ³ B: 15 cm ³	A	A	A
Program Duration (h:min)	03:41	00:50	01:57
Electricity consumption (kWh/cycle)	0.937	1.100	1.700
Water consumption (l/cycle)	9.0	12.0	17.2

- The program duration may change according to the amount of dishes, the water temperature, the ambient temperature and selected additional functions.
- Values given for programmes other than the eco programme are indicative only.
- **Smart Eco program** is suitable to clean normally soiled tableware, that for this use, it is the most efficient programme in terms of its combined energy and water consumption.
- Washing tableware in a household dishwasher usually consumes less energy and water in the use phase than hand dishwashing when the household dishwasher is used according to the manufacturer's instructions.
- Only use powder detergent for short programs.
- Short programs do not include drying.
- To assist drying, we recommend slightly opening the door after a cycle is complete.

8. CLEANING AND MAINTENANCE

Cleaning your dishwasher is important to maintain the machine's service life. Make sure that the water softening setting (If available) is done correctly and correct amount of detergent is used to prevent limescale accumulation. Refill the salt compartment when the salt sensor light comes on.

Oil and limescale may build up in your Dishwasher over time. If this occurs:

- Fill the detergent compartment but do not load any dishes. Select a programme which runs at high temperature and run the Dishwasher empty. If this does not clean your Dishwasher sufficiently, use a cleaning agent designed for use with dishwashers.
- To extend the life of your dishwasher, clean the appliance regularly on each month.
- Wipe the door seals regularly with a damp cloth to remove any accumulated residue or foreign objects.

Filters

Clean the filters and spray arms at least once a week. If any food waste remains or foreign objects on the coarse and fine filters, remove them and clean them thoroughly with water.

- a) Micro Filter
- b) Coarse Filter
- c) Metal Filter

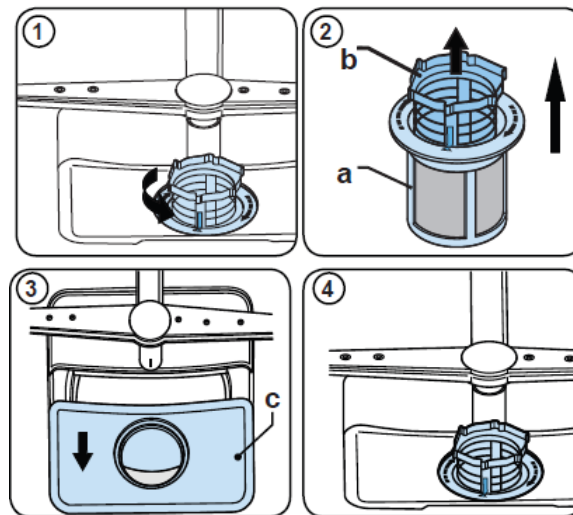

- Step 1: To remove and clean the filter combination, turn it counter clockwise and remove it by lifting it upwards.
- Step 2: Pull the coarse filter out of the micro filter.
- Step 3: Then pull and remove the metal filter. Rinse the filter with lots of water until it is free of residue.
- Step 4: Reassemble the filters. Replace the filter insert, and rotate it clockwise.

 **NOTE:** Never use your dishwasher without a filter.

 **NOTE:** Incorrect fitting of the filter will reduce the washing effectiveness.

 **NOTE:** Clean filters are necessary for proper running of the machine.

Spray arms

Make sure that the spray holes are not clogged and that no food waste or foreign object is stuck to the spray arms. If there is any clogging, remove the spray arms and clean them under water. To remove the upper spray arm undo the nut holding it in position by turning it clockwise and pulling it downwards. Make sure that the nut is properly tightened when refitting the upper spray arm.

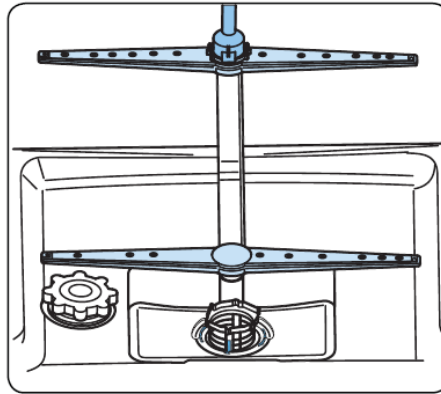

Drain Pump

Large food residues or foreign objects which were not captured by the filters may block the waste water pump. The rinsing water will then be above the filter.

⚠ Warning Risk of cuts!

When cleaning the waste water pump, ensure that you do not injure yourself on pieces of broken glass or pointed implements.

In this case:

1. First always disconnect the appliance from the power supply.
2. Take out baskets.
3. Remove the filters.
4. Scoop out water, use a sponge if required.
5. Check the area and remove any foreign objects.
6. Install filters.
7. Re-insert baskets.

9. TROUBLESHOOTING

FAULT	POSSIBLE CAUSE	TROUBLESHOOTING
White stains remain on dishes.	Not enough detergent used.	Use the correct amount of detergent, as instructed in the program table.
	Rinse aid dosage and/or water softener setting set too low.	Increase rinse aid and/or water softener level.
	High water hardness level.	Increase water softener level and add salt.
	Salt compartment cap not closed properly.	Check that the salt compartment cap is closed properly.
Dishes do not dry.	Drying option is not selected.	Select a program with a drying option.
	Rinse aid dosage set too low.	Increase rinse aid dosage setting.
Rust stains form on the dishes.	Stainless-steel quality of the dishes is insufficient.	Use only dishwasher-proof sets.
	High level of salt in wash water.	Adjust the water hardness level using water hardness table.
	Salt compartment cap not closed properly.	Check that the salt compartment cap is closed properly.
	Too much salt spilled in the Dishwasher while filling it with salt.	Use funnel while filling salt to the compartment to avoid spillage.
	A poor main grounding.	Consult a qualified electrician immediately.
Detergent remains in the detergent compartment.	Detergent was added when the detergent compartment was wet.	Make sure detergent compartment is dry before use.

10. ERROR CODE

ERROR CODE	POSSIBLE FAULT	WHAT TO DO
FF	Water inlet system failure	Make sure the water inlet tap is open and water is flowing.
		Separate the inlet hose from the tap and clean the filter of the hose.
		Contact for service if the error continues.
F5	Pressure system failure	Contact for service.
F3	Continuous water input	Close the tap and contact for service.
F2	Inability to discharge water	Water discharge hose and filters may be clogged.
		Cancel the program.
		If the error continues, contact for service.
F8	Heater error	Contact for service.
F1	Overflow	Unplug the machine and close the tap.
		Contact for service.
FE	Faulty electronic card	Contact for service.
F7	Overheating	Contact for service.
F6	Faulty heater sensor	Contact for service.
HI	High voltage failure	Contact for service.
LO	Low voltage failure	Contact for service.

The installation and repairing procedures should always be carried out by the Authorised Service Agent in order to avoid possible risks. The manufacturer shall not be held liable for damages that may arise from procedures carried out by unauthorised persons. Repairs may be carried out by technicians only. If a component has to be replaced, ensure that only original spare parts are used. Improper repairs or use of non-original spare parts may cause considerable damage and put the user at considerable risk. Contact information for your customer service such as after sales service number can be found on warranty card

11. TECHNICAL SPECIFICATION

Model	EDW-M1331D(WH)
Capacity	13 Place Settings
Voltage	220–240V~
Frequency	50Hz
Total Power	1,900W
Rated Current	10A
Water Supply Pressure	Max: 1 (Mpa). Min: 0.03 (Mpa)
Product Dimension (mm)	598 (W) x 850 (H) x 598 (D)
Carton Dimension (mm)	644 (W) x 881 (H) x 661 (D)
Net / Gross Weight	46.1 KGS / 47.7 KGS

ELBA