



ELBA

BUILT-IN OVEN **MODEL: EBO-M7388(BK)**

Owner's Manual

Please read this manual carefully before operating your set.

Retain it for future reference.

Record model number and serial number of the set.

See the label attached on the set and quote this information to your dealer when you require service.

For The Warranty Terms & Conditions, Please Refer To Warranty Certificate

CONTENTS

1. SAFETY PRECAUTIONS.....	1
2. ATTENTIONS.....	2
3. INSTALLATION.....	2
3.1 BEFORE THE INSTALLATION.....	2
3.2 INSTALLATION OF BUILT-IN OVEN.....	3
3.3 ACCESSORIES.....	3-4
4. CONNECTION OF THE APPLIANCE.....	5
4.1 FITTING ON A POWER SUPPLY CABLE.....	5
4.2 CONNECTING THE SUPPLY CABLE TO THE MAINS.....	5
5. HOW TO USE YOUR OVEN.....	5-6
6. PRODUCT DESCRIPTIONS.....	6
7. PROGRAMS AND FUNCTIONS.....	7
7.1 SELECTING THE COOKING PROGRAMS.....	7
7.2 SELECTING THE COOKING DURATION.....	8
7.3 SELECTING THE MANUAL MODE FUNCTION SETTING.....	8
7.4 SELECTING THE COOKING TEMPERATURE.....	8
8. CLEANING AND MAINTENANCE.....	8-9
9. TECHNICAL SPECIFICATION.....	10

We recommend that you read the instructions in this owner's manual carefully before using it for the best performance and to extend the lifespan of your appliance, as it will provide you with all the instructions you require to ensure its safe installation, use and maintenance.

1. SAFETY PRECAUTIONS

- In order to avoid bump against people or oven during transportation, please grip the handle on the two external sides. Do not carry the appliance at the front handle, this might damage the oven door.
- To ensure your safety, all electric appliances should only be installed or serviced by qualified technician. If the supply cord is damaged, it must be replaced by the authorized service center or similarly qualified technician in order to avoid hazard.
- Do not place supply cord on the edge of table and counter, or near any heating appliance.
- In order to avoid electric shock, do not immerse supply cord, plug or other parts into water.
- Do not place the appliance near electric stove, heated oven, microwave or other heat source.
- In order to avoid burning or explosion, combustibles or flammable material (curtains, cloth, wallpaper and others) should be kept away from the appliance.
- Do not place paperboard, plastic or other similar items in the oven. When the oven is not being used, everything should be removed except provided accessory.
- Do not cover slag pan or other parts with tinsel since it will result overheat.
- Accessible parts may become hot during use, please keep away from children.
- Never obstruct vents provided for ventilation and heat dispersal.
- The ends of door handle may become hot during use, please grip the middle parts.
- Disconnect the oven from the power supply before cleaning or maintenance.
- When the appliance is faulty, please contact the authorized service center.
- Always use insulation gloves to carry ovenware or handle oil plate.
- Disconnect the oven from the power supply and waiting until it is cool, before cleaning.
- In order to avoid electric shock, never use wire brush to clean the appliance since pieces of metal is easy to touch live part.
- Never use metal scouring pads or sharp scrapers which will damage the door surface or interior wall, leading to glass broken or scratches of the enamel.
- In order to avoid burn or electric shock, never put too much food or metal utensils.
- Please make sure the oven function has been switched off when it is not be used.
- Unplug from the socket when you are planning not to use the oven for long time.
- Never use your oven outside the cabinet.
- Other purpose except baking is not allowed.
- Do not lean or rest on the opened oven door. This may damage the oven. The door can bear a maximum weight of 8 kg.

2. ATTENTIONS

- In order to avoid electric shock, please make sure the oven has been shut off before carrying out the maintenance.
- Use only original accessories provided by ELBA or its authorized service center.
- Do not use wet parts of body to touch the oven.
- Do not pull and push the oven by its supply cord, this may lead to socket disconnection.
- Improper or dangerous operations are forbidden.
- Do not let the power cord of other appliances to touch the heated parts of the oven.
- The oven should not be exposed to rain or direct sunshine.
- Do not use or store flammable objects near to the oven.

Distributors decline all liability for not following above instructions or some improper operations which caused personal injury and property loss.

3. INSTALLATION

3.1 Before the Installation

- Please check the products and make sure that there is no damage caused by striking or heavy load.
- The oven door is level, and you can open and close the oven door flexibly.
- Specification on the marking plate is in compliance with the regulations.

If the oven appears in an abnormal way, do not install and unplug the power supply before contacting the authorized service center. Do not attempt to repair or service the oven by yourself. Repair or maintenance should only be carried out by a qualified technician or the authorized service center.

This appliance must be installed only by qualified technician or the authorized service center. Manufacturer declines all responsibility for improper installation, which may harm persons and cause damage to the property.

Important:

- The power supply to the appliance must be cut off before any adjustments or maintenance work is carried out.
- The AC power supply should be supplied with 220-240V~, 50/60Hz with minimum 15A distribution circuit fuse or at least 15A distribution circuit breaker.

3.2 Installation of Built-in Oven

The material of the cabinet should be insulated, and the clearance between the edge of the cabinet and the oven should be over 100mm for ventilation. The panels of the adjacent cabinets must be made of heat-resistant material which can withstand temperatures of up to 100°C. In compliance with current safety standards, contact with the electrical parts of the oven must not be possible once it has been installed.

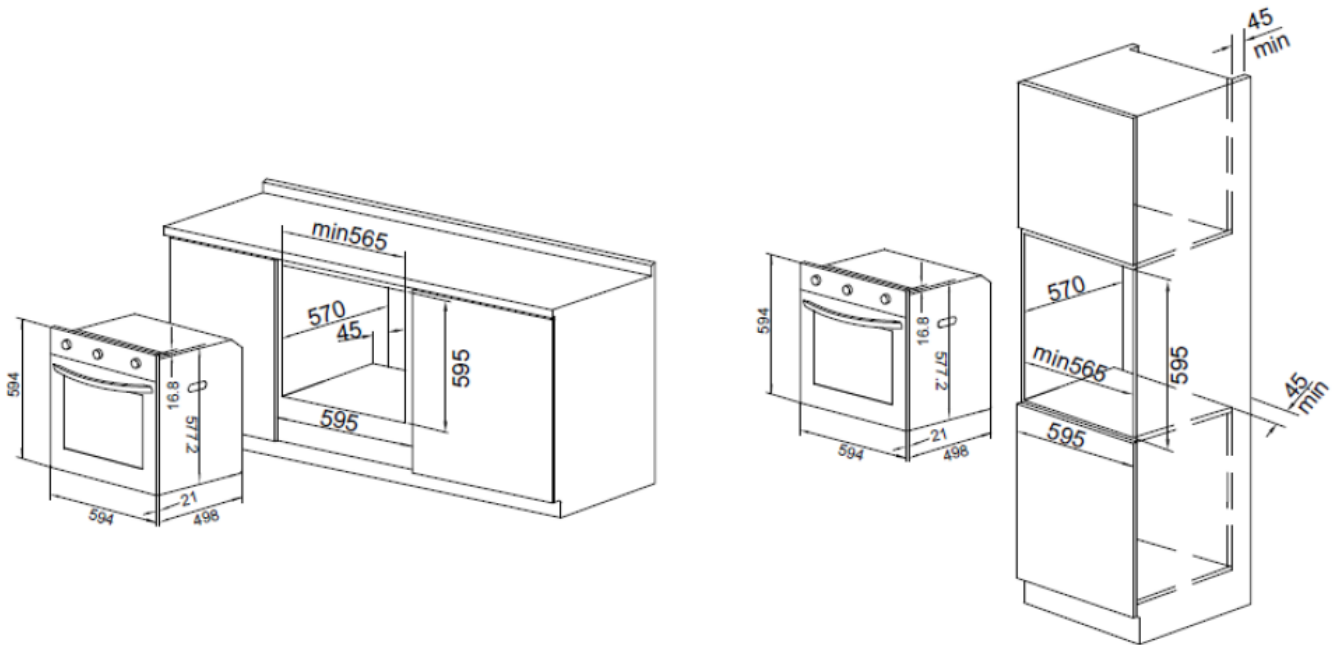

3.3 Accessories

Grilling Rack

For roasting and grilling.

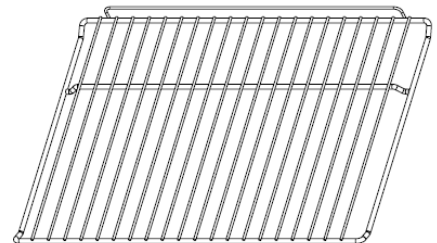

Baking Tray

For cooking large quantity of food such as cakes, pastries, frozen food and etc. For use in collecting oil spillage and meat juices.

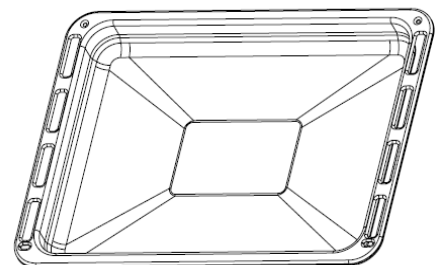

Shelves Positioning

To ensure the appliance to operate safely, correct placement of the shelves on the side rails is required. This is to ensure that the food will not slide out or during removal of the shelves.

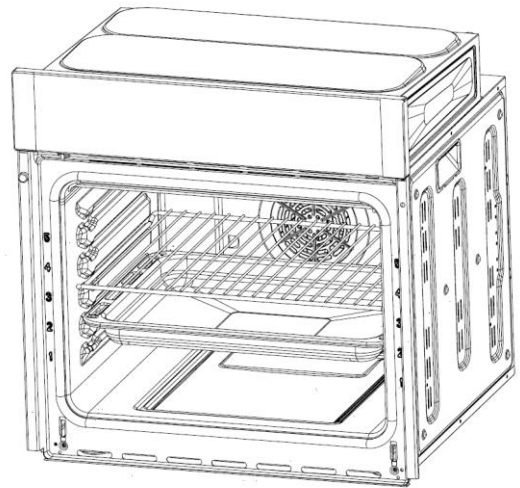

Rotisserie Usage

The rotisserie works in combination with the grill element to heat the food equally.

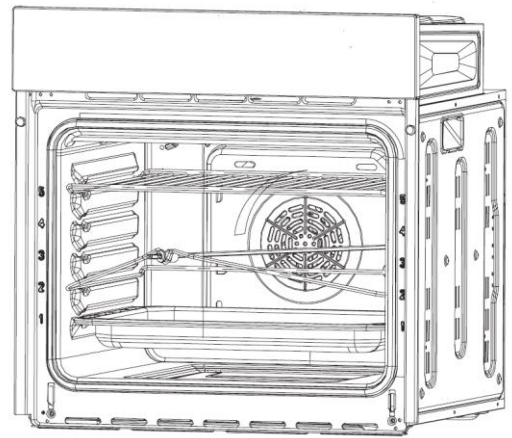

Note: Please do not use the handle to carry or move the oven during installation or handling.

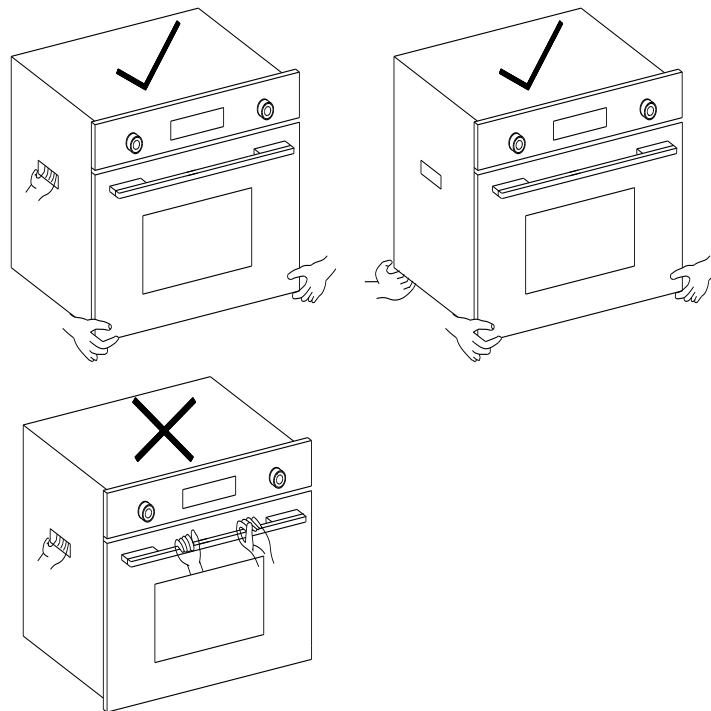

4. CONNECTION OF THE APPLIANCE

4.1 Fitting on a Power Supply Cable

The appliance has to be equipped with a three-core power supply cable which is designed to operate with an alternating current. The AC power supply should be supplied with 220-240V~, 50/60Hz and a minimum 15A distribution circuit fuse or at least 15A distribution circuit breaker.

4.2 Connecting the Supply Cable to the Mains

Install a standardized plug corresponding to the load indicated on the marking plate. The supply cable should be positioned so that it does not reach a temperature of more than 50°C with respect to the room temperature, anywhere along its length, or protected by insulation having an appropriate rating.

Before making the connection, check that:

- The electrical safety of this appliance can only be guaranteed if the appliance is correctly and efficiently earthed, in compliance with regulations on electrical safety.
- Always ensure that the earthling is connected. If you have any doubts please contact a qualified technician to check the connection. The manufacturer declines all liability of damage resulting from a connection which has not been earthed properly.
- Before plugging the appliance into the mains, check that the specifications indicated on the marking plate correspond to the electrical mains system of your home.
- Check that the electrical capacity of the system and sockets will support the maximum power of the appliance, as indicated on the marking plate.
- If the socket and appliance plug are not compatible, have the socket replaced with a suitable model by a qualified technician. The latter, in particular, will also have to ensure that the cross sections of the socket cables are suitable for the power absorbed by the appliance.
- The use of adapters, multiple sockets and /or extensions, is not recommended. If their use cannot be avoided, remember to use only single or multiple adapters and extensions which comply with current safety regulations. In these cases, never exceed the maximum current capacity indicated on the single adapter or extension and the maximum power indicated on the multiple adapter .The plug and socket must be easily accessible.

5. HOW TO USE YOUR OVEN

- The first time you use your appliance, we recommend that set the thermostat to the highest setting and leave the oven on for about half an hour with nothing in it, with the oven door shut completely. Then open the oven door and let the air in. The odor that is often detected during this initial use is due to the evaporation of substances used to protect the oven during storage and until it is installed.

- Place the baking tray provided at the bottom shelf of the oven to prevent any sauce and/or grease from dripping onto the bottom of the oven only when grilling food or when using the rotisserie. For all other types of baking, never use the bottom shelf and never place anything on the bottom of the oven when it is in operation because this could damage the enamel. Always place your cookware (dishes, aluminum foil, etc.) on the grilling rack provided with the appliance inserted especially along the oven guides.
- After baking food contains sugar and salt, please clean your oven promptly, or these will attach to the oven surface.
- Use baking tray to roast high temperature food such as meat, poultry, fish, and others.

6. PRODUCT DESCRIPTION

Cooking Function

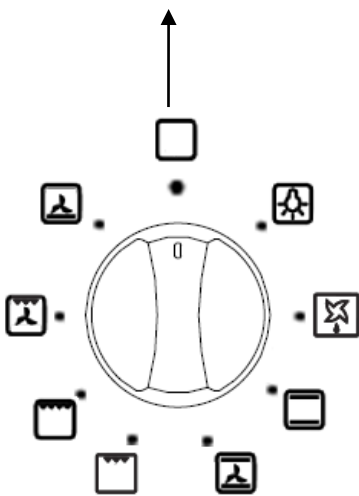

Cooking Time Setting

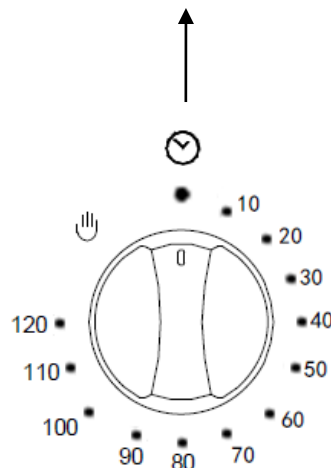

Temperature Setting

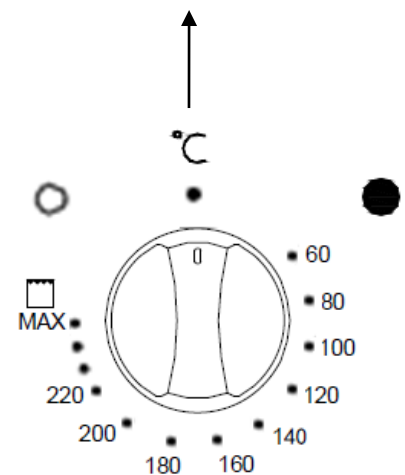

 Manual Cooking Time









 Oven Indication Light

 Max Temperature 250°C

7. PROGRAMS AND FUNCTIONS

7.1 Selecting the Cooking Programs

To select the cooking programs, turn the knob to desire program. The detail programs as below:

Symbol	Function Descriptions
	Oven Lamp: Enables the user to observe the progress of cooking without opening the door.
	Defrost: The circulation of air at room temperature enables quicker thawing of frozen food (without the use of any heat). It is a gentle but quick way to speed up the defrosting time and thawing of ready-made and cream filled dishes.
	Top and Bottom Heating: The top and bottom element work together to provide conventional cooking. The oven needs to be pre-heated to the required temperature and is ideal for single item such as large cakes. Best results are achieved by placing food in the center of the oven.
	Bottom Heating with Fan: Combination of the fan and bottom heating elements provides more even heat distribution, saving up to 30-40% of energy. Dishes slightly brown on the outside and still moist on the inside. This program is suitable for cooking dishes with gravy and sauce at higher temperature.
	Top Grilling: The top grilling element switches on and off to maintain at certain temperature. The temperature range can be set within the range of 50-250°C. Suitable for grilling small amount of meat and ribs.
	Double Top Grilling: The double top grilling element switches on two powerful upper element and off to maintain at certain temperature. The temperature range can be set within the range of 50-250°C. This program can be used together with the rotisserie. You can use this function for tender cuts of meat, steak, chops, sausages, fish, cheese toasties and other quick cooking foods.
	Top with Fan: The top heating elements and the fan work together. This combination of features increases the effectiveness of the unidirectional thermal radiation of the heating elements through forced circulation of the air throughout the oven. This helps prevent food from burning on the surface, allowing the heat to penetrate right into the food. Excellent results are achieved with kebabs made with meats and vegetables, sausages, ribs lamb chops, chicken in a spicy sauce, etc.
	Conventional with Fan: The top, bottom element and fan work together to provide conventional cooking with even heat. The oven needs to be pre-heated to the required temperature and is ideal for fast cooking. Best results are achieved by placing food in the center of the oven.

7.2 Selecting the Cooking Duration

This function is used to operate the oven in the desired duration.

7.3 Selecting the Manual Mode Function Settings

To operate in manual mode, turn the knob to “” in cooking time setting to enter the manual mode. The cooking duration has to be controlled by the user.

7.4 Selecting the Cooking Temperature

This function is used to set the desired cooking temperature. The temperature “MAX ” is at 250°C.

NOTE: Due to external environment factor, the temperature set may be slightly different to the actual temperature inside the oven.

8. CLEANING AND MAINTENANCE

Before cleaning or performing maintenance on your oven, disconnect the oven from the power supply. To extend the lifespan of your oven, it must be cleaned frequently.

The enamel or stainless steel parts should be cleaned with lukewarm water without using any abrasive powders or corrosive substances which could damage the surface. If the stains are difficult to be removed, use mild cleaner with hot soapy water to clean the area.

- The inside of the oven should preferably be cleaned after using. With the oven temperature cool down, clean the oven with hot soapy water. The soap must be rinsed away and the interior to dry thoroughly. Avoid using abrasive detergents (for example cleaning powders, acid, thinner and etc.) as these could damage the enamel part of the oven. Never use a steam cleaner to clean the inside of the oven.
- Never put aluminum foil at the bottom of the oven, as the accumulation of heat could compromise the baking and damage the enamel. There is a risk of fire if the aluminum foil or baking material touches the heating element.
- Clean the glass door using non-abrasive products or sponges and dry it with a soft cloth.

Replacing the Oven Lamp

- 1) Disconnect the oven from the power supply and unplug the oven if the plug is accessible.
- 2) Remove the glass cover of the lamp holder by turning it counter-clockwise.
- 3) Turn the bulb counter-clockwise to remove the bulb and replace with a bulb resistant to high temperatures. (300° C).
- 4) Replace the glass cover and reconnect the oven to the mains power supply.

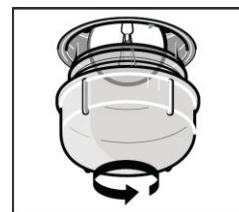

Removing the Oven Door

For a thorough cleaning, you can remove the oven door. Proceed as follow:

- 1) Open the oven door to the fullest extends.
- 2) Open the lever A completely on the left and right hinge (Fig.2).
- 3) Hold the door as shown (Fig.3).
- 4) Gently close the door until left and right hinge levers A are hooked to part B of the door and remove the door when part C is fully attached with door (Fig.4).
- 5) Reassemble the door by following the above procedures backwards.

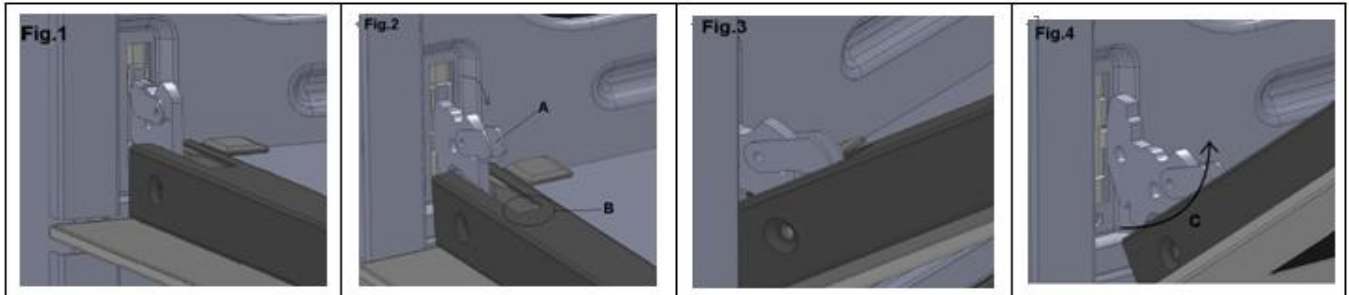

Removing the Inner Glass Door

To remove the inner glass door, proceed as follow:

1. Remove the seal G by unscrew the bolts on two sides.
2. Gently pull out the inner glass and remove it (fig.2)
3. Clean the glass and other components with an appropriate cleaner. Dry thoroughly, and place on a soft surface.
4. Reassemble the door by following the above procedures backwards.

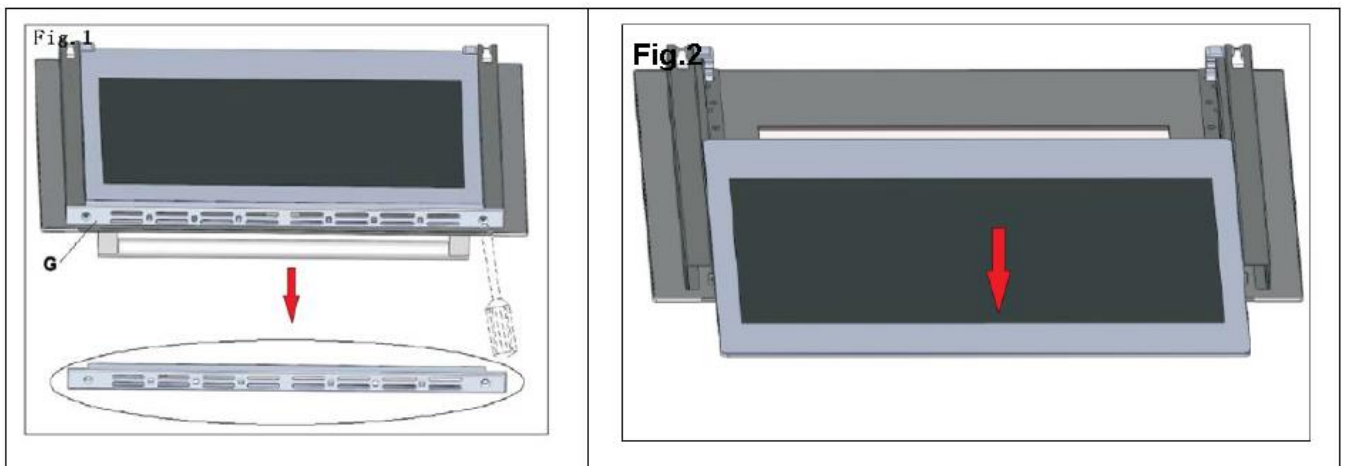

9. TECHNICAL SPECIFICATION

Model	EBO-M7388(BK)
Capacity	73L
Voltage	220 – 240V~
Frequency	50/60Hz
Rated Power	2100 – 2500W
Product Dimension (mm)	594 (W) x 594 (H) x 498 (D)
Built-in Dimension (mm)	565 (W) x 595 (H) x 570 (D)
Carton Dimension (mm)	639 (W) x 658 (H) x 579 (D)
Gross / Net Weight	41.0 KGS / 37.0 KGS

Notice:

Physical measurement may be different from label because of the products is in continuous improvement. Please refer to physical measurement to make sure definite size.

NOTICE

This product must not be disposed together with domestic waste. It has to be disposed at an authorized place for recycling of electrical and electronic appliances. By collecting and recycling waste, you help to save natural resources and make sure the product is disposed in an environmental friendly and healthy way.



ELBA