

# USER'S GUIDE

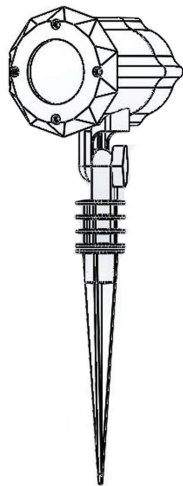

Item Number: LM-LL-RGBMP-0001



MADE IN CHINA

## Safety Attention

**CAUTION!** – Use of controls or adjustments or performance of procedures other than those specified herein may result in hazardous radiation exposure.

This laser product has been properly reported to FDA in compliance with Part 1002, Title 21 of the United States Code of Federal Regulation(CFR). Besides, it meets the requirements for Class 2 Laser Product, tested by Eurofins Product Testing Service (Shanghai) Co., Ltd

**UNDER NO CIRCUMSTANCE** shall attempts be made to open the protective housing or operate the device if the aperture windows are damaged.

## LASER SAFETY WARNINGS

Potential laser injury hazard exists with this product! Read these instructions carefully, which includes below warnings and instruction to use and assembly!

- Avoid direct eye contact with laser light. It is best to position the light away from doorways or areas where people walk. It is best to position the light to other parts of the house or gardens, walls, fences, trees etc. Never intentionally expose your eyes or those of others to direct laser light.
- This laser product can potentially cause instant eye injury if shined directly into person's eyes.
- Do not open the housing or attempt any repairs yourself.

## NON-INTERLOCKED HOUSING WARNING

This unit contains high power laser devices internally. Do not open the laser housing, due to potential exposure to unsafe levels of laser radiation. The laser power levels accessible if the unit is opened can cause blindness, skin burns and fires.

For safety purposes, do not try to relocate or mount the light while it's on. Do not point towards any person, vehicles, traffic routes or flying air-craft overhead.

**Laser Radiation**  
**Avoid Direct Eye Contact**  
**Class 2 Laser Product**

**Diode Laser**  
**Max Output <1mW**  
**Wavelengths: 450-650nm**

## Product Specification

Laser Classification / Power	Class II / Less than 1 mW (single beam)
Laser Wavelength(s)	532nm Green / 660nm Red/450nm Blue
Laser Diode Life	About 8000 hours (at 4hrs per day)
Power Input	120 - 240V AC (provided transformer)
Operating Environment	Indoor / Outdoor; -15° F to 90° F
Waterproof Level	IP65 for the light and IP44 for Adaptor
Projection Coverage	50 ft. X 50 ft.
Maintenance	Maintenance Free

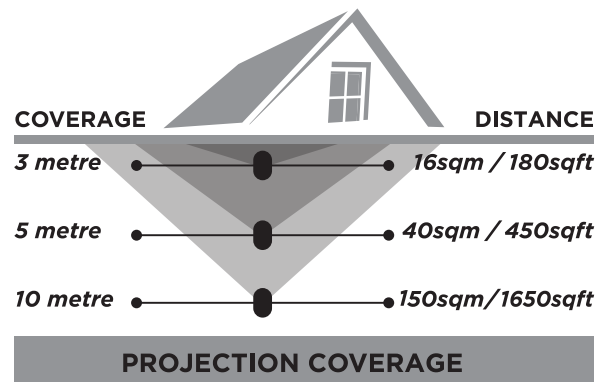

**Please Note:** The closer the projection surface the more intense and bright the Laser light. Projecting from a further distance will increase coverage but reduce brightness.

## Assembly Before You Begin

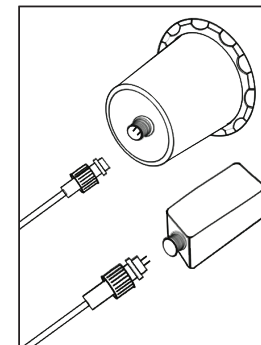
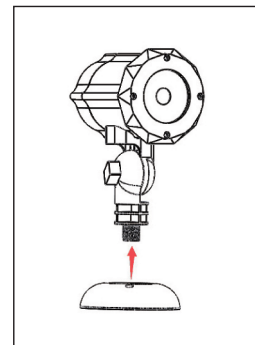
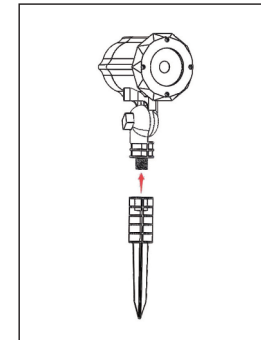
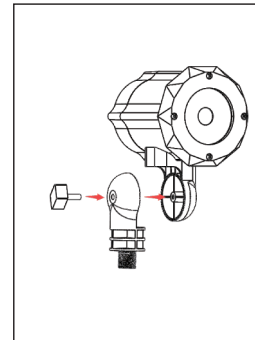

\*Position the projector by loosening and tightening the angle adjustment screws.

\*Attach the cable to the adaptor and the projector light by fully inserting the two-pronged plug and tighten the wire cap.

## Remote Guide

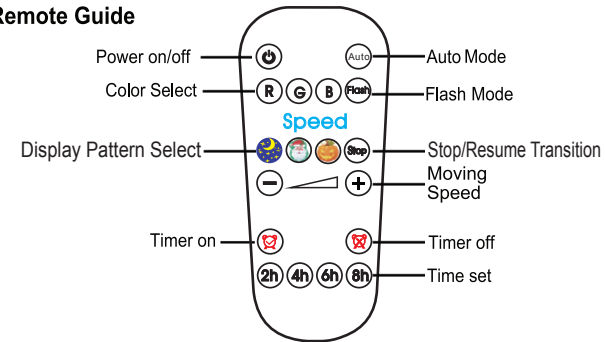

- 1.Power ON/OFF - The light will default to turn on when plugged in. Pressing the power button will turn the lights OFF or back on.
- 2.Color select - Pressing RGB button will turn on relevant color.  
 Note: Certain surfaces reflect colors better than others. For instance, a green laser reflects off of leaves better than red lasers.
- 3.Auto- auto mode, the laser lights will turn on randomly.
- 4.Flash Mode - Press this button, the laser lights will flash.  
 Display Pattern Select- Select different themes Stars, Christmas and Halloween by these 3 buttons.  
 Stop-Press this button, the laser light will stop changing and project only one image.
- 5.Speed - Press this to adjust flash/moving speed(static,medium, fast).
- 6.Timer on/off. Press timer on button and select the time for light on. Press timer off button to reset time select or cancel timer.
- 7.Time set. (2, 4, 6, or 8 hours) – Press timer on button and press # hours and then the light will go into standby Mode after # hours. For example, If you want your light to display from 6pm to midnight daily: At desired time, in this case, 6pm, press the "6h" button. The lights will turn off after 6hrs (midnight) and will cycle again to turn on at 6pm the next day and so on. Timer settings will be saved until timer reset or if the unit is unplugged. A triple-flash indication from the projector will confirm your timer setting.
- 8.Retractable Antenna – Extend for maximum range (Up to 50 ft. depending on surroundings).

Please feel free to contact us if any problem you may have at following mail: [sales@ledmall.com](mailto:sales@ledmall.com) or visit our web: [www.ledmall.com](http://www.ledmall.com) for detail information.