

3M™ Water Filtration Products

SPEC# _____

QUANTITY _____

application: **MULTIPLE EQUIPMENT**

models:

DP190/DP195



3M Purification Inc. Water Filtration Products Models DP190 & DP195 dual port water filtration systems help provide consistent high quality water for the multiple applications of cold beverages, ice and coffee at a combined flow rate of up to 5 gpm (18.9 lpm). Two separate streams exit the manifold. Both streams have reduced sediment and chlorine taste and odor. One stream has added scale inhibition media from a dedicated cartridge to help reduce the ability of calcium and magnesium to precipitate as hard scale on the evaporator plates of an ice machine and/or the heating coils of a coffee brewer. The second stream supplies cold beverage dispensers and includes no added scale inhibitor.

The DP190 filters combine chlorine taste and odor reduction with cyst, bacteria and sediment reduction to 0.2 micron. **The DP195 filters** combine chlorine taste and odor reduction with sediment reduction to 3 micron for more turbid water.

PRODUCT BENEFITS

- One system with dual outlet connections simultaneously supplies cold beverage dispensers and ice machines/coffee brewers.
- Up to 5 gpm (18.9 lpm) total flow of water especially treated for consistent great tasting cold beverages, clearer and consistent ice and the perfect cup of coffee or tea.
- Revolutionary **Integrated Membrane Pre-Activated Carbon Technology ("IMPACT")** dual-zone media cartridge construction combines a membrane in series with premium activated carbon to provide superior throughput and cartridge life.
- Reduction of up to 99.99% of common water-borne heterotrophic bacteria by membrane filtration as tested by 3M Purification (HF90 replacement cartridge).
- NSF and/or FDA CFR-21 compliant materials.
- Built-in bacteria inhibitor intended to reduce fouling of media (HF90 replacement cartridge).
- Reduction of scale build-up on evaporator plates and heating coils from a controlled forced-feed orifice addition of scale inhibitor, as tested by 3M Purification.
- Sanitary Quick Change (SQC) encapsulated cartridge design allows for fast and easy cartridge change-outs with a 1/4 turn.
- 3/4" NPT horizontal inlet and outlet ports allow direct or easily adaptable connections to existing plumbing lines.
- Expansion kit available to serve higher capacities and flow rates.
- Manifold includes outlet check valves.

PRODUCT SPECIFICATIONS

Model Number	Part Number	Reduction Claims	Nominal Micron Rating	Capacity	Service Flow Rate	Application	Replacement Cartridge	Sizing
DP190	56243-01	Cysts ¹ , Bacteria ² , Sediment, Chlorine Taste and Odor, Scale	0.2	54,000 gallons (204,412 liters)	5.0 gpm (18.9 lpm)	Most Normal Water	DP190 CARTRIDGE 56138-01 (HF90 & HF8-S)	For simultaneous operation of carbonators, coffee machines and ice machines
DP195	56243-02	Sediment, Chlorine Taste and Odor, Scale	3			Higher Turbidity Water	DP195 CARTRIDGE 56138-04 (HF95 & HF8-S)	

¹Includes oocysts of cryptosporidium and toxoplasma and cysts of giardia and entamoeba
²As tested with E.Coli ATCC (11229)



DP190/DP195

SPEC# _____
QUANTITY _____
MODEL NUMBER _____
PART NUMBER _____

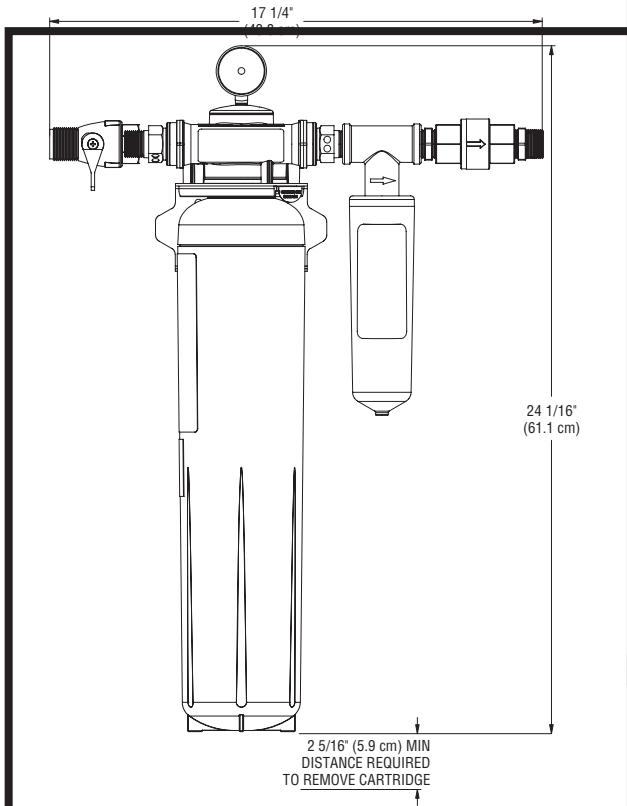

⚠ WARNING: To reduce the risk associated with the ingestion of contaminants:

- Do not use with water that is microbiologically unsafe or of unknown quality without adequate disinfection before or after the system. Systems certified for cyst reduction may be used on disinfected water that may contain filterable cysts. EPA Establishment #070595-CT-001

3M Purification Inc. recommends regularly scheduled maintenance and replacement of the filter cartridge(s) in order for the product to perform as advertised/sold. 3M Purification shall not be liable for system failures due to improper maintenance.

LIMITED WARRANTY

3M Purification Inc. warrants this Product will be free from defects in material and manufacture for five (5) years from the date of purchase: The filter cartridge or filter membrane is warranted to be free from defects in material and manufacture for one (1) year. This warranty does not cover failures resulting from abuse, misuse, alteration or damage not caused by 3M Purification Inc. or failure to follow installation and use instructions. No warranty is given as to the service life of any filter cartridge or membrane as it will vary with local water conditions and water consumption. 3M PURIFICATION INC. MAKES NO OTHER WARRANTIES OR CONDITIONS, EXPRESS OR IMPLIED, INCLUDING, BUT NOT LIMITED TO, ANY IMPLIED WARRANTY OR CONDITION OF MERCHANTABILITY OR FITNESS FOR A PARTICULAR PURPOSE OR ANY IMPLIED WARRANTY OR CONDITION ARISING OUT OF A COURSE OF DEALING, CUSTOMER OR USAGE OF TRADE. If the Product fails to satisfy this Limited Warranty during the warranty period, 3M Purification Inc. will replace the Product or refund your Product purchase price. This warranty does not cover labor. The remedy stated in this paragraph is Customer's sole remedy and 3M Purification Inc.'s exclusive obligation. For additional information, see the entire Limited Warranty located in the product Installation and Operating Instruction Manual.

Limitation of Liability: 3M Purification Inc. will not be liable for any loss or damage arising from this 3M Purification Inc. product, whether direct, indirect, special, incidental, or consequential, regardless of the legal theory asserted, including warranty, contract, negligence or strict liability. Some states and countries do not allow the exclusion or limitation of incidental or consequential damages, so the above limitation or exclusion may not apply to you.

3M Purification Inc. Water Filtration Products

PHYSICAL SPECIFICATIONS

- System includes a single cartridge manifold with built-in pressure gauge, inlet water shut-off valve, outlet check valves, mounting brackets, a single cartridge filter and a dedicated external scale inhibition cartridge.
- Inlet and outlet plumbing connections are 3/4" NPT (choice of male or female is included).
- Filter cartridge is o-ring seal type.
- System maximum operating pressure of 125 psi (862 kPa) and operating temperature of 100°F (37.8°C).
- Recommended combined service flow rate is up to 5 gpm (18.9 lpm).
- Filter cartridge incorporates a bacteriostatic carbon block filtration medium (HF90 replacement cartridge). Second cartridge includes a scale inhibition medium (HF8-S).
- System materials are NSF and/or FDA CFR-21 compliant.
- Cartridges are sanitary in design, requiring no contact with the filter media during cartridge change-out.
- Filter cartridges require no pre-activation.
- Shipping weight: 15 lbs. (6.8 kg).
- Operating weight: 16.5 lbs. (7.5 kg).

IMPORTANT: INSTALLATION TIPS

These installation tips are for informational purposes only and are not intended to be used as actual installation instructions. CAUTION: To reduce the risk associated with property damage due to water leakage:

- **Read and follow** Use Instructions before installation and use of this system.
- Installation and use **MUST** comply with all state and local plumbing codes.
- **Protect from freezing**, remove filter cartridge when temperatures are expected to drop below 40°F (4.4°C).
- **Do not install on hot water supply lines.** The maximum operating water temperature of this filter system is 100°F (37.8°C).
- **Do not install** if water pressure exceeds 125 psi (862 kPa). If your water pressure exceeds 80 psi (552 kPa), you must install a pressure limiting valve. Contact a plumbing professional if you are uncertain how to check your water pressure.
- **Do not install** where water hammer conditions may occur. If water hammer conditions exist you must install a water hammer arrester. Contact a plumbing professional if you are uncertain how to check for this condition.
- The disposable filter cartridge **MUST** be replaced every 12 months, at the rated capacity or if a noticeable reduction in flow rate occurs.



3M Purification Inc.
400 Research Parkway
Meriden, CT 06450 U.S.A.
Toll Free: 1.800.243.6894
Worldwide: 203.237.5541
Fax: 203.630.4530
www.3mpurification.com

3M is a trademark of 3M Company.
© 2011 3M Company. All rights reserved.
LITFS295 0811B
70-0201-9421-6
Please recycle. Printed in U.S.A.

3M™ Water Filtration Products

SPEC# _____

QUANTITY _____

application: **MULTIPLE EQUIPMENT**

models:

High Flow Series Cyst Replacement Cartridges



3M™ Water Filtration Products line of cyst reduction replacement cartridges offer multiple solutions to help improve the taste, appearance and consistency of your product at flow rates from 1 gpm up to 5 gpm

PRODUCT BENEFITS

- Sanitary Quick Change (SQC) encapsulated cartridge design reduces media contamination during change-outs.
- Expansive breadth of product offering that can accommodate most applications.
- Multiple choice of medias to help provide solutions for varying water conditions.
- Certified by NSF to Standard 53 for cyst¹ reduction.
- FDA CFR-21 compliant materials.
- NSF certified; 3M Purification: Commercial Modular-High Flow Series.
- Contains, Integrated Pre-Activated Carbon Technology ("I.M.P.A.C.T.") media HF40 series thru HF90 series only excluding HF90-S-SR, HF90-S-SR5.

PRODUCT SPECIFICATIONS

Model No.	Part No	3M ID#	Micron Rating	Claims	Flow Rate	Capacity
HF90	5613503	70020020155	0.2	Bacteria ² , Bacteriostatic, Particulate, Chlorine Taste & Odor, Turbidity, Cyst ¹	5 gpm (18.9 lpm)	54,000 gals. (204,412 lit.)
HF90-S	5613505	70020020163	0.2	Bacteria ² , Bacteriostatic, Particulate, Chlorine Taste & Odor, Turbidity, Cyst ¹ , Scale Inhibitor ³	5 gpm (18.9 lpm)	54,000 gals. (204,412 lit.)
HF90-S-SR	5617105	70020020767	0.2	Bacteria ² , Bacteriostatic, Particulate, cyst ¹ , Scale Inhibitor ³	5 gpm (18.9 lpm)	N/A
HF90-S-SR5	5617107	70020020775	0.2	Bacteria ² , Bacteriostatic, Particulate, cyst ¹ , scale inhibitor ³	5 gpm (18.9 lpm)	N/A
HF60	5613403	70020020122	0.2	Bacteria ² , Bacteriostatic, Particulate, Chlorine Taste & Odor, Cyst ¹	3.34 gpm (12.6 lpm)	35,000 gals. (132,489 lit.)
HF60-S	5613405	70020116706	0.2	Bacteria ² , Bacteriostatic, Particulate, Chlorine Taste & Odor, Cyst ¹ , Scale Inhibitor ³	3.34 gpm (12.6 lpm)	35,000 gals. (132,489 lit.)
HF40	5613303	70020020114	0.2	Bacteria ² , Bacteriostatic, Particulate, Chlorine Taste & Odor, Cyst ¹	2.1 gpm (7.9 lpm)	25,000 gals. (94,635 lit.)
HF40-S	5613305	70020121417	0.2	Bacteria ² , Bacteriostatic, Particulate, Chlorine Taste & Odor, Cyst ¹ , Scale Inhibitor ³	2.1 gpm (7.9 lpm)	25,000 gals. (94,635 lit.)
HF30	5615105	70020020577	0.5	Particulate, Chlorine Taste & Odor, Cyst ¹	1.67 gpm (6.3 lpm)	14,000 gals. (52,996 lit.)
HF30-S	5615107	70020020585	0.5	Particulate, Chlorine Taste & Odor, Cyst ¹ , Scale Inhibitor ³	1.67 gpm (6.3 lpm)	14,000 gals. (52,996 lit.)
HF30-MS	5615111	70020020601	0.5	Particulate, Chlorine Taste & Odor, Cyst ¹ , proprietary Scale Inhibitor blend ³	1.67 gpm (6.3 lpm)	14,000 gals. (52,996 lit.)
HF20	5615101	70020020551	0.5	Particulate, Chlorine Taste & Odor, Cyst ¹	1.5 gpm (5.7 lpm)	9,000 gals. (34,069 lit.)
HF20-S	5615103	70020020569	0.5	Particulate, Chlorine Taste & Odor, Cyst ¹ , Scale Inhibitor ³	1.5 gpm (5.7 lpm)	9,000 gals. (34,069 lit.)
HF20-MS	5615109	70020020593	0.5	Particulate, Chlorine Taste & Odor, Cyst ¹ , Scale Inhibitor blend ³	1.5 gpm (5.7 lpm)	9,000 gals. (34,069 lit.)
HF10-MS	5609329	70020019595	0.5	Particulate, Chlorine Taste & Odor, Cyst ¹ , Scale Inhibitor blend ³	1.0 gpm (3.8 lpm)	3,500 gals. (13,249 lit.)

¹Based on the use of Cryptosporidium parvum oocysts.

²As tested with E.Coli ATCC (11229). As tested and verified by manufacturer's laboratory.

³As tested and verified by manufacturer's laboratory.



Cyst Replacement Cartridges

3M™ Water Filtration Products

SPEC# _____

QUANTITY _____

MODEL NUMBER _____

PART NUMBER _____

Model No.	Part No	Shipping Dimension	Weight	Case Qty
HF90	5613503	28" x 4-7/8" x 4-7/8" (71.1 cm. x 12.4 cm. x 12.4 cm)	5 lbs. (2.3 kg.)	1
HF90-S	5613505	28" x 4-7/8" x 4-7/8" (71.1 cm. x 12.4 cm. x 12.4 cm)"	5 lbs. (2.3 kg.)	1
HF90-S-SR	5617105	28" x 4-7/8" x 4-7/8" (71.1 cm. x 12.4 cm. x 12.4 cm)	5 lbs. (2.3 kg.)	1
HF90-S-SR5	5617107	28" x 4-7/8" x 4-7/8" (71.1 cm. x 12.4 cm. x 12.4 cm)	5 lbs. (2.3 kg.)	1
HF60	5613403	22" x 4-7/8" x 4-7/8" (55.9 cm. x 12.4 cm. x 12.4 cm)	3.4 lbs. (1.5 kg.)	1
HF60-S	5613405	22" x 4-7/8" x 4-7/8" (55.9 cm. x 12.4 cm. x 12.4 cm)	3.4 lbs. (1.5 kg.)	1
HF40	5613303	10-1/2" x 5-1/2" x 23-1/4" (26.7 cm. x 14 cm. x 59.1 cm)	5 lbs. (2.3 kg.)	2
HF40-S	5613305	10-1/2" x 5-1/2" x 23-1/4" (26.7 cm. x 14 cm. x 59.1 cm)	5 lbs. (2.3 kg.)	2
HF30	5615105	10-1/2" x 10-1/2" x 28-1/4" (26.7 cm. x 26.7 cm. x 71.8 cm)	9 lbs. (4.1 kg.)	4
HF30-S	5615107	10-1/2" x 10-1/2" x 28-1/4" (26.7 cm. x 26.7 cm. x 71.8 cm)	"9 lbs. (4.1 kg.)"	4
HF30-MS	5615111	10-1/2" x 10-1/2" x 28-1/4" (26.7 cm. x 26.7 cm. x 71.8 cm)	9 lbs. (4.1 kg.)	4
HF20	5615101	15-1/4" x 10-1/2" x 23-1/4" (38.7 cm. x 26.7 cm. x 59.1 cm)	"10 lbs. (4.5 kg.)"	6
HF20-S	5615103	15-1/4" x 10-1/2" x 23-1/4" (38.7 cm. x 26.7 cm. x 59.1 cm)	10 lbs. (4.5 kg.)	6
HF20-MS	5615109	15-1/4" x 10-1/2" x 23-1/4" (38.7 cm. x 26.7 cm. x 59.1 cm)	10 lbs. (4.5 kg.)	6
HF10-MS	5609329	20-3/8" x 10-1/2" x 15-3/4" (51.8 cm. x 26.7 cm. x 40.0 cm)	10 lbs. (4.5 kg.)	8

SPECIFICATIONS

- Maximum operating pressure of 125 psi (862 kPa) and operating temperature of 100° (37.8°C).
- Materials are FDA CFR-21 Compliant.
- Shipping weight: Refer to Price Book
- Operating weight: Contact factory

IMPORTANT: INSTALLATION TIPS

These installation tips are for informational purposes only and are not intended to be used as actual installation instructions.

⚠️WARNING: To reduce the risk associated with the ingestion of contaminants:

- **Do not use with water that is microbiologically unsafe or of unknown quality without adequate disinfection before or after the system.** Systems certified for cyst reduction may be used on disinfected water that contain filterable cysts. EPA Establishment #070595-CT-001.

CAUTION: To reduce the risk associated with property damage due to water leakage:

- **Read and follow** Use Instructions before installation and use of this system.
- Installation and use **MUST** comply with all state and local plumbing codes.
- **Protect from freezing**, remove filter cartridge when temperatures are expected to drop below 40°F (4.4°C).
- **Do not install on hot water supply lines.** The maximum operating water temperature of this filter system is 100°F (37.8°C).
- **Do not install** if water pressure exceeds 125 psi (862 kPa). If your water pressure exceeds 80 psi (552 kPa), you must install a pressure limiting valve. Contact a plumbing professional if you are uncertain how to check your water pressure.
- **Do not install** where water hammer conditions may occur. If water hammer conditions exist you must install a water hammer arrester. Contact a plumbing professional if you are uncertain how to check for this condition.
- The disposable filter cartridge **MUST** be replaced every twelve (12) months, at the rated capacity or sooner if a noticeable reduction in flow rate occurs.

LIMITED WARRANTY

3M Purification Inc. warrants this Product will be free from defects in material and manufacture for one (1) year from the date of purchase: This warranty does not cover failures resulting from abuse, misuse, alteration or damage not caused by 3M Purification Inc. or failure to follow installation and use instructions. No warranty is given as to the service life of any filter cartridge or membrane as it will vary with local water conditions and water consumption. **3M PURIFICATION INC. MAKES NO OTHER WARRANTIES OR CONDITIONS, EXPRESS OR IMPLIED, INCLUDING, BUT NOT LIMITED TO, ANY IMPLIED WARRANTY OR CONDITION OF MERCHANTABILITY OR FITNESS FOR A PARTICULAR PURPOSE OR ANY IMPLIED WARRANTY OR CONDITION ARISING OUT OF A COURSE OF DEALING, CUSTOMER OR USAGE OF TRADE.** If the Product fails to satisfy this Limited Warranty during the warranty period, 3M Purification Inc. will replace the Product or refund your Product purchase price. This warranty does not cover labor. **The remedy stated in this paragraph is Customer's sole remedy and 3M Purification Inc.'s exclusive obligation. For additional information, see the entire Limited Warranty located in the product Installation and Operating Instruction Manual.**

Limitation of Liability. 3M Purification Inc. will not be liable for any loss or damage arising from this 3M Purification Inc. product, whether direct, indirect, special, incidental, or consequential, regardless of the legal theory asserted, including warranty, contract, negligence or strict liability. Some states and countries do not allow the exclusion or limitation of incidental or consequential damages, so the above limitation or exclusion may not apply to you.



3M Purification Inc.
400 Research Parkway
Meriden, CT 06450 U.S.A.
Toll Free: 1-866-990-9785
Worldwide: 203-237-5541
Fax: 203-238-8977
www.3Mfoodservice.com • 3Mpurification.com

3M is a trademark of 3M Company.
© 2013 3M Company. All rights reserved.
70020303148 REV 0513

3M™ Water Filtration Products

3M™ High Flow Series Cyst Rated Cartridges

3M Water Filtration Products' line of cyst reduction rated cartridges offers multiple solutions to help improve the taste, appearance and consistency of your product at flow rates from 1 gpm up to 5 gpm.

Product Benefits:

- Sanitary Quick Change (SQC) encapsulated cartridge design reduces media contamination during change-outs
- Expansive breadth of product offerings that can accommodate most applications
- Multiple choice of medias to help provide solutions for varying water conditions
- Certified by NSF to Standard 53 for cyst¹ reduction
- NSF and CSA certified
- Contains Integrated Membrane Pre-Activated Carbon Technology ("I.M.P.A.C.T.") media; HF20-I, HF20-SI and HF40 through HF90 Series only



Model Number	3M ID	Part No	Micron Rating	Claims	Flow Rate	Capacity
HF90	70020020155	5613503	0.2	Bacteria ² , Particulate, Chlorine Taste and Odour, Cyst ¹	5 gpm (18.9 lpm)	54,000 gal (204,412 L)
HF90-S	70020020163	5613505	0.2	Bacteria ² , Particulate, Chlorine Taste and Odour, Cyst ¹ , Scale Inhibitor ³	5 gpm (18.9 lpm)	54,000 gal (204,412 L)
HF60	70020020122	5613403	0.2	Bacteria ² , Particulate, Chlorine Taste and Odour, Cyst ¹	3.34 gpm (12.6 lpm)	35,000 gal (132,489 L)
HF60-S	70020116706	5613405	0.2	Bacteria ² , Particulate, Chlorine Taste and Odour, Cyst ¹ , Scale Inhibitor ³	3.34 gpm (12.6 lpm)	35,000 gal (132,489 L)
HF40	70020020114	5613303	0.2	Bacteria ² , Particulate, Chlorine Taste and Odour, Cyst ¹	2.1 gpm (7.9 lpm)	25,000 gal (94,635 L)
HF40-S	70020121417	5613305	0.2	Bacteria ² , Particulate, Chlorine Taste and Odour, Cyst ¹ , Scale Inhibitor ³	2.1 gpm (7.9 lpm)	25,000 gal (94,635 L)
HF30	70020020577	5615105	0.5	Particulate, Chlorine Taste and Odour, Cyst ¹	1.67 gpm (6.3 lpm)	14,000 gal (52,996 L)
HF30-S	70020020585	5615107	0.5	Particulate, Chlorine Taste and Odour, Cyst ¹ , Scale Inhibitor ³	1.67 gpm (6.3 lpm)	14,000 gal (52,996 L)
HF30-MS	70020020601	5615111	0.5	Particulate, Chlorine Taste and Odour, Cyst ¹ , Scale Inhibitor ³	1.67 gpm (6.3 lpm)	14,000 gal (52,996 L)
HF20	70020020551	5615101	0.5	Particulate, Chlorine Taste and Odour, Cyst ¹	1.5 gpm (5.7 lpm)	9,000 gal (34,069 L)
HF20-I	70020352327	5636428	0.2	Bacteria ² , Particulate, Chlorine Taste and Odour, Cyst ¹	1.67 gpm (6.3 lpm)	14,000 gal (52,996 L)
HF20-S	70020020569	5615103	0.5	Particulate, Chlorine Taste and Odour, Cyst ¹ , Scale Inhibitor ³	1.5 gpm (5.7 lpm)	9,000 gal (34,069 L)
HF20-SI	70020352335	5636429	0.2	Bacteria ² , Particulate, Chlorine Taste and Odour, Cyst ¹ , Scale Inhibitor ³	1.67 gpm (6.3 lpm)	14,000 gal (52,996 L)
HF20-MS	70020020593	5615109	0.5	Particulate, Chlorine Taste and Odour, Cyst ¹ , Scale Inhibitor ³	1.5 gpm (5.7 lpm)	9,000 gal (34,069 L)
HF10-MS	70020019595	5609329	0.5	Particulate, Chlorine Taste and Odour, Cyst ¹ , Scale Inhibitor ³	1.0 gpm (3.8 lpm)	3,500 gal (13,249 L)

1. Based on the use of Cryptosporidium parvum oocysts.
 2. As tested with E.Coli ATCC (11229). As tested and verified by manufacturer's laboratory.
 3. As tested and verified by manufacturer's laboratory.

3M Water Filtration Products

Product Specifications:

- Temperature: 4.4°C - 37.8°C (40°F - 100°F)
- Pressure: 172 - 862 kPa (25 - 125 psi)
- Shipping weight: Refer to Price Book
- Operating weight: Contact factory

Spec # _____

Quantity _____

Model # _____

Part # _____

Shipping Specifications

Model No.	Part No.	Shipping Dimension	Weight	Case Qty.
HF90	5613503	71.1 cm × 12.4 cm × 12.4 cm (28"H × 4-7/8"W × 4-7/8"L)	2.3 kg (5 lb)	1
HF90-S	5613505	71.1 cm × 12.4 cm × 12.4 cm (28"H × 4-7/8"W × 4-7/8"L)	2.3 kg (5 lb)	1
HF60	5613403	55.9 cm × 12.4 cm × 12.4 cm (22"H × 4-7/8"W × 4-7/8"L)	1.5 kg (3.4 lb)	1
HF60-S	5613405	55.9 cm × 12.4 cm × 12.4 cm (22"H × 4-7/8"W × 4-7/8"L)	1.5 kg (3.4 lb)	1
HF40	5613303	26.7 cm × 14 cm × 59.1 cm (10-1/2"H × 5-1/2"W × 23-1/4"L)	2.3 kg (5 lb)	2
HF40-S	5613305	26.7 cm × 14 cm × 59.1 cm (10-1/2"H × 5-1/2"W × 23-1/4"L)	2.3 kg (5 lb)	2
HF30	5615105	26.7 cm × 26.7 cm × 71.8 cm (10-1/2"H × 10-1/2"W × 28-1/4"L)	4.1 kg (9 lb)	4
HF30-S	5615107	26.7 cm × 26.7 cm × 71.8 cm (10-1/2"H × 10-1/2"W × 28-1/4"L)	4.1 kg (9 lb)	4
HF30-MS	5615111	26.7 cm × 26.7 cm × 71.8 cm (10-1/2"H × 10-1/2"W × 28-1/4"L)	4.1 kg (9 lb)	4
HF20	5615101	38.7 cm × 26.7 cm × 59.1 cm (15-1/4"H × 10-1/2"W × 23-1/4"L)	4.5 kg (10 lb)	6
HF20-I	5636428	20.64 cm × 29.53 cm × 41.91 cm (8.13"H × 11.63"W × 16.5"L)	6.75 kg (14.88 lb)	6
HF20-S	5615103	38.7 cm × 26.7 cm × 59.1 cm (15-1/4"H × 10-1/2"W × 23-1/4"L)	4.5 kg (10 lb)	6
HF20-SI	5636429	20.64 cm × 29.53 cm × 41.91 cm (8.13"H × 11.63"W × 16.5"L)	6.89 kg (15.18 lb)	6
HF20-MS	5615109	38.7 cm × 26.7 cm × 59.1 cm (15-1/4"H × 10-1/2"W × 23-1/4"L)	4.5 kg (10 lb)	6
HF10-MS	5609329	51.8 cm × 26.7 cm × 40.0 cm (20-3/8"H × 10-1/2"W × 15-3/4"L)	4.5 kg (10 lb)	8

Important Installation Tips:

These installation tips are for informational purposes only and are not intended to be used as actual installation instructions.

⚠ WARNING: To reduce the risk associated with the ingestion of contaminants:

- **DO NOT use with water that is microbiologically unsafe or of unknown quality without adequate disinfection before or after the system.** Systems certified for cyst reduction may be used on disinfected water that contain filterable cysts.

CAUTION: To reduce the risk associated with property damage due to water leakage:

- **Read and follow** Use Instructions before installation and use of this system.
- Installation and use **MUST** comply with all provincial and local plumbing codes.
- **Protect from freezing**, remove filter cartridge when temperatures are expected to drop below 4.4°C (40°F).
- **DO NOT install on hot water supply lines.** The maximum operating water temperature of this filter system is 37.8°C (100°F).
- **DO NOT install** if water pressure exceeds 862 kPa (125 psi). If your water pressure exceeds 552 kPa (80 psi), you must install a pressure limiting valve. Contact a plumbing professional if you are uncertain how to check your water pressure.
- **DO NOT install** where water hammer conditions may occur. If water hammer conditions exist you must install a water hammer arrester. Contact a plumbing professional if you are uncertain how to check for this condition.
- The disposable filter cartridge **MUST** be replaced every twelve (12) months, at the rated capacity or sooner if a noticeable reduction in flow rate occurs.

Limited Warranty

Warranty, Limited Remedy, and Disclaimer: 3M warrants that each 3M product meets the applicable 3M product specification at the time 3M ships the product. 3M MAKES NO OTHER EXPRESS OR IMPLIED WARRANTIES OR CONDITIONS, INCLUDING ANY IMPLIED WARRANTY OR CONDITION OF MERCHANTABILITY OR FITNESS FOR A PARTICULAR PURPOSE. If a 3M product does not conform to this warranty, the sole and exclusive remedy is, at 3M's option, replacement of the 3M product or refund of the purchase price.

Limitation of Liability: Except for the limited remedy above, and except to the extent prohibited by law, 3M will not be liable for any loss or damage arising from or related to the 3M product, whether direct, indirect, special, incidental, or consequential, regardless of the legal or equitable theory asserted.



3M Separation and Purification
Sciences Division

3M Canada
P.O. Box 5757
London, ON N6A 4T1

1-800-364-3577
3M.ca/FoodServiceFiltration



System tested and certified by NSF international against NSF/ANSI 42 and 53 for the reduction of the claims specified on the Performance Data Sheet and against CSA B483.1.

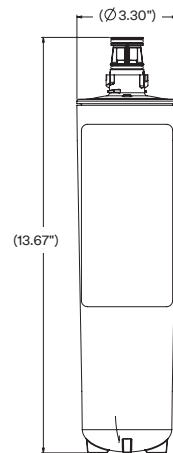

3M and 3M Science. Applied to Life, are trademarks of 3M. Used under license in Canada. © 2021, 3M. All rights reserved. 2103-19803 E



High Flow
Series Filters

3M™ Water Filtration Products

Performance Data Sheets

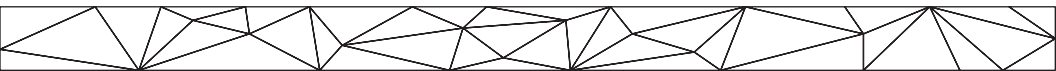

Table of Contents

DWS160-L.....	3
HF05-MS.....	4
HF15-MS.....	6
HF10-MS	8
HF20, HF20-S, HF20-MS.....	10
HF25, HF25-S, HF25-MS.....	12
HF30, HF30-S, HF30-MS.....	14
HF35-CL.....	16
HF35, HF35-S, HF35-MS.....	18
HF20-I, HF20-SI	20
HF40, HF40-S.....	22
HF45, HF45-S	24
HF60, HF60-S.....	26
HF65, HF65-S	28
HF60-CL, HF60-CLS.....	30
HF65-CL.....	32
HF90-CL, HF90-CLS.....	34
HF95-CL.....	36
HF90, HF90-S.....	38
HF95, HF95-S	40
HF20-A020-SR.....	42
HF20-A020-S-SR	44
HF20-S-SR.....	46
HF40-S-SR.....	48
HF60-A020-S-SR.....	50
HF60-S-SR, HF60-S-SR5.....	52
HF90-SR, HF90-S-SR, HF90-S-SR5.....	54



Performance Data Sheet

Model: DWS160-L

Use Replacement Cartridge 160-L.

The concentration of the indicated substances in water entering the system was reduced to a concentration less than or equal to the permissible limit for water leaving the system as specified in NSF/ANSI Standard 42 and Standard 53.



System tested and certified by NSF International against NSF/ANSI Standard 42 and Standard 53 for the reduction of substances listed below.

Capacity: 6000 Gallons (22,712 Liters) Contaminant Reduction Determined by NSF testing.

Contaminant	Average Influent Concentration	NSF specified Challenge Concentration	Avg % Reduction	Average Product Water Concentration	Max Permissible Product Water Concentration	NSF Reduction Requirements	NSF Test Report
Chlorine Taste and Odor	2.0 mg/L	2.0 mg/L ± 10%	97.5%	0.05 mg/L	N/A	≥ 50%	J-001456899
Nominal Particulate Class L, ≥0.5 to < 1.0 µm	4, 666,667 pts/mL	At least 10,000 particles/mL	99.9%	2565 pts/ml	N/A	≥85%	J-00126785
Benzene	0.017 mg/L	0.015 mg/L ± 10%	>97.1%	0.0005 mg/L	0.005 mg/L	N/A	J-00144130
Cyst*	120,000 cysts/L	Minimum 50,000 cysts/L	99.99%	13 cyst/L	N/A	≥99.95%	J-00126784
Lead pH @8.5	0.150 mg/L	0.15 mg/L ± 10%	>99.3%	0.001 mg/L	0.010 mg/L	N/A	J-00144127
Lead pH @8.5	0.150 mg/L	0.15 mg/L ± 10%	>99.3%	0.001 mg/L	0.010 mg/L	N/A	J-00144129
P-Dichlorobenzene	0.225 mg/L	0.225 mg/L ± 10%	99.7%	0.0005 mg/L	0.075 mg/L	N/A	J-00144131
Toxaphene	0.017 mg/L	0.015 mg/L ± 10%	>93.9%	0.001 mg/L	0.003 mg/L	N/A	J-00144132

* Based on the use of *Cryptosporidium parvum* oocysts

Application Guidelines/Water Supply Parameters

Service Flow	2.5 gpm (9.4 lpm)
Water Supply	Potable Water
Water Pressure	25 - 125 psi (172 - 862 kPa)
Water Temperature	40° F - 100° F (4.4° C - 38° C)

It is essential that the manufacturer's recommended installation, maintenance and filter replacement requirements be carried out for the product to perform as advertised. See Installation Manual for Warranty information.

Note: While the testing was performed under standard laboratory conditions, actual performance may vary.

Replacement Cartridge: 160-L. For estimated costs of replacement elements please call 866.990.9785 or visit our website at www.3Mpurification.com

Parts and service available from:



3M Purification Inc.
 400 Research Parkway
 Meriden, CT 06450, U.S.A.
 Tel (866) 990-9785
 (203) 237-5541
 Fax (203) 238-8701
www.3Mpurification.com

3M is a trademark of 3M Company used under license.
 © 2020 3M Company. All rights reserved.
 NSF is a trademark of NSF International

⚠ WARNING

Read entire manual. Failure to follow all guides and rules could cause personal injury or property damage.

- Check with your local public works department for plumbing codes. You must follow their guidelines as you install the water filtration system.

- Your water filtration system will withstand up to 125 pounds per square inch (psi) water pressure. If your house water supply pressure is higher than 80 psi, install a pressure reducing valve before installing the water filtration system.

To reduce the risk associated with the ingestion of contaminants:

- DO NOT use with water that is microbiologically unsafe or of unknown quality without adequate disinfection before or after the system. Systems certified for cyst reduction may be used on disinfected water that may contain filterable cysts.

NOTICE

To reduce the risk associated with water leakage or flooding:

- Read and follow Use Instructions before installation and use of this system.
- Change the disposable filter cartridge at the recommended interval; the disposable filter cartridge MUST be replaced every 12 months or sooner.
- Failure to replace the disposable filter cartridge at recommended intervals may lead to reduced filter performance and failure of the filter, causing property damage from water leakage or flooding.
- Flush 5.0 gallons through cartridge before use (flush approximately 2 minutes).

Performance Data Sheet

Model: High Flow Series/HF05-MS

Use Replacement Cartridge HF05-MS

The concentration of the indicated substances in water entering the system was reduced to a concentration less than or equal to the permissible limit for water leaving the system as specified in NSF/ANSI Standard 42 and CSA B483.1.



System tested and certified by NSF International against NSF/ANSI Standard 42 and CSA B483.1 for the reduction of substances as listed below.

Capacity: See chart on next page.
Contaminant Reduction Determined by NSF testing.

Substance Reduction	Average Influent	NSF/ANSI specified Challenge Concentration	Avg % Reduction	Average Product Water Concentration	Max Permissible Product Water Concentration	NSF Reduction Requirements	NSF Test Report
Chlorine Taste and Odor	1.9 mg/L	2.0 mg/L ± 10%	99.9%	0.05 mg/L	N/A	≥ 50%	J-00177388

FOR COMMERCIAL USE ONLY

Application Guidelines/Water Supply Parameters
Service Flow
Water Supply
Water Pressure
Water Temperature

See chart on next page.
Potable Water
25-125 psi (172 – 862 kPa)
40° F - 100° F (4.4° C - 38° C)

It is essential that the manufacturer's recommended installation, maintenance and filter replacement requirements be carried out for the product to perform as advertised. See System Installation Manual for Warranty information.

Note: While the testing was performed under standard laboratory conditions, actual performance may vary.

Replacement Cartridge: HF05-MS. For estimated costs of replacement elements please call 866.990.9785 or visit our website at www.3Mpurification.com



Parts and service available from:

3M Purification Inc.
400 Research Parkway
Mendenot, NJ 06450, U.S.A.
Tel: (866) 990-9785
(203) 237-5541
Fax: (203) 238-8701
www.3Mpurification.com

3M is a trademark of 3M Company used under license.
© 2020 3M Company. All rights reserved.
NSF is a trademark of NSF International



WARNING
Read entire manual. Failure to follow all guides and rules could cause personal injury or property damage.

- Check with your local public works department for plumbing codes. You must follow their guidelines as you install the water filtration system.
- Your water filtration system will withstand up to 125 pounds per square inch (psi) water pressure. If your house water supply pressure is higher than 80 psi, install a pressure reducing valve before installing the water filtration system.

To reduce the risk associated with the ingestion of contaminants:

- DO NOT use with water that is microbiologically unsafe or of unknown quality without adequate disinfection before or after the system.

NOTICE

To reduce the risk associated with water leakage or flooding:

- Read and follow Use Instructions before installation and use of this system.
- Change the disposable filter cartridge at the recommended interval; the disposable filter cartridge **MUST** be replaced every 12 months or sooner.
- Failure to replace the disposable filter cartridge at recommended intervals may lead to reduced filter performance and failure of the filter, causing property damage from water leakage or flooding.

Performance Data Sheet

Model: High Flow Series/HF05-MS

Use Replacement Cartridge HF05-MS

HF05-MS Cartridge Flow and Capacity Information

Head & Manifold	# of Cartridges	Flow Rate	Flush Instructions	Capacity
NH3 Series Head	1	.75 gpm (2.8 lpm)	Flush 1.5 gals through cartridge(s) before use (flush approx. 2 mins.)	1,500 gallons (5,678 liters)
VH3 Series Head	1	.75 gpm (2.8 lpm)	Flush 1.5 gals through cartridge(s) before use (flush approx. 2 mins.)	1,500 gallons (5,678 liters)
High Flow Series Twin 2XX Manifold	2	1.5 gpm (5.7 lpm)	Flush 3.0 gals through cartridge(s) before use (flush approx. 2 mins.)	3,000 gallons (11,356 liters)
High Flow Series Triple 3XX Manifold	3	2.25 gpm (8.5 lpm)	Flush 4.5 gals through cartridge(s) before use (flush approx. 2 mins.)	4,500 gallons (17,034 liters)
High Flow Series Single DF1XX Manifold	1	.75 gpm (2.8 lpm)	Flush 1.5 gals through cartridge(s) before use (flush approx. 2 mins.)	1,500 gallons (5,678 liters)
High Flow Series Twin DF2XX Manifold	2	1.5 gpm (5.7 lpm)	Flush 3.0 gals through cartridge(s) before use (flush approx. 2 mins.)	3,000 gallons (11,356 liters)
High Flow Series Single DP1XX Manifold	1	.75 gpm (2.8 lpm)	Flush 1.5 gals through cartridge(s) before use (flush approx. 2 mins.)	1,500 gallons (5,678 liters)
High Flow Series Twin DP2XX Manifold	2	1.5 gpm (5.7 lpm)	Flush 3.0 gals through cartridge(s) before use (flush approx. 2 mins.)	3,000 gallons (11,356 liters)
High Flow Series Triple DP3XX Manifold	3	2.25 gpm (8.5 lpm)	Flush 4.5 gals through cartridge(s) before use (flush approx. 2 mins.)	4,500 gallons (17,034 liters)
High Flow Series Single SF1XX Manifold	1	.75 gpm (2.8 lpm)	Flush 1.5 gals through cartridge(s) before use (flush approx. 2 mins.)	1,500 gallons (5,678 liters)
High Flow Series DIDF2XX Manifold	2	1.5 gpm (5.7 lpm)	Flush 3.0 gals through cartridge(s) before use (flush approx. 2 mins.)	3,000 gallons (11,356 liters)

Performance Data Sheet

Model: High Flow Series/HF15-MS

Use Replacement Cartridge HF15-MS

The concentration of the indicated substances in water entering the system was reduced to a concentration less than or equal to the permissible limit for water leaving the system as specified in NSF/ANSI Standard 42 and CSA B483.1.



System tested and certified by NSF International against NSF/ANSI Standard 42 and CSA B483.1 for the reduction of substances as listed below.

Capacity: See chart on next page.
Contaminant Reduction: Determined by NSF testing.

Substance Reduction	Average Influent	NSF/ANSI specified Challenge Concentration	Avg % Reduction	Average Product Water Concentration	Max Permissible Product Water Concentration	NSF Reduction Requirements	NSF Test Report
Chlorine Taste and Odor	2.0 mg/L	2.0 mg/L ± 10%	90.5%	0.19 mg/L	N/A	≥ 50%	J-00177392
Particulate Class I, ≥0.5 to <1.0 µm	7,900,000 particles/mL	At least 10,000 particles/mL	99.9%	1815 pts/mL	N/A	≥ 85%	J-00100653

FOR COMMERCIAL USE ONLY

Application Guidelines/Water Supply Parameters

Service Flow	See chart on next page
Water Supply	Potable Water
Water Pressure	25 -125 psi (172 – 862 kPa)
Water Temperature	40° F - 100° F (4.4° C - 38° C)

It is essential that the manufacturer's recommended installation, maintenance and filter replacement requirements be carried out for the product to perform as advertised. See Installation Manual for Warranty information.

Note: While the testing was performed under standard laboratory conditions, actual performance may vary.

Replacement Cartridge: HF15-MS. For estimated costs of replacement elements please call 866.990.9785 or visit our website at www.3Mpurification.com

Parts and service available from:



3M Purification Inc.
400 Research Parkway
Meriden, CT 06450, U.S.A.
Tel (866) 990-9785
(203) 237-5541
Fax (203) 238-8701
www.3Mpurification.com

3M is a trademark of 3M Company used under license.
© 2020 3M Company. All rights reserved.
NSF is a trademark of NSF International

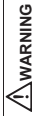

WARNING
Read entire manual. Failure to follow all guides and rules could cause personal injury or property damage.

- Check with your local public works department for plumbing codes. You must follow their guidelines as you install the water filtration system.
 - Your water filtration system will withstand up to 125 pounds per square inch (psi) water pressure. If your house water supply pressure is higher than 80 psi, install a pressure reducing valve before installing the water filtration system.
- To reduce the risk associated with the ingestion of contaminants:**
- DO NOT use with water that is microbiologically unsafe or of unknown quality without adequate disinfection before or after the system.

NOTICE

To reduce the risk associated with water leakage or flooding:

- Read and follow Use Instructions before installation and use of this system.
- Change the disposable filter cartridge at the recommended interval; the disposable filter cartridge MUST be replaced every 12 months or sooner.
- Failure to replace the disposable filter cartridge at recommended intervals may lead to reduced filter performance and failure of the filter, causing property damage from water leakage or flooding.

Performance Data Sheet
Model: High Flow Series/HF15-MS
 Use Replacement Cartridge HF15-MS

HF15-MS Cartridge Flow and Capacity Information

Head & Manifold	# of Cartridges	Flow Rate	Flush Instructions	Capacity
NH3 Series Head	1	1 gpm (3.8 lpm)	Flush 2.0 gals through cartridge(s) before use (flush approx. 2 mins.)	3,500 gallons (13,249 liters)
VH3 Series Head	1	1 gpm (3.8 lpm)	Flush 2.0 gals through cartridge(s) before use (flush approx. 2 mins.)	3,500 gallons (13,249 liters)
High Flow Series Twin 2XX Manifold	2	2 gpm (7.57 lpm)	Flush 4.0 gals through cartridge(s) before use (flush approx. 2 mins.)	7,000 gallons (26,498 liters)
High Flow Series Triple 3XX Manifold	3	3 gpm (11.36 lpm)	Flush 6.0 gals through cartridge(s) before use (flush approx. 2 mins.)	10,500 gallons (39,747 liters)
High Flow Series Single DF1XX Manifold	1	1 gpm (3.8 lpm)	Flush 2.0 gals through cartridge(s) before use (flush approx. 2 mins.)	3,500 gallons (13,249 liters)
High Flow Series Twin DF2XX Manifold	2	2 gpm (7.57 lpm)	Flush 4.0 gals through cartridge(s) before use (flush approx. 2 mins.)	7,000 gallons (26,498 liters)
High Flow Series Single DP1XX Manifold	1	1 gpm (3.8 lpm)	Flush 2.0 gals through cartridge(s) before use (flush approx. 2 mins.)	3,500 gallons (13,249 liters)
High Flow Series Twin DP2XX Manifold	2	2 gpm (7.57 lpm)	Flush 4.0 gals through cartridge(s) before use (flush approx. 2 mins.)	7,000 gallons (26,498 liters)
High Flow Series Triple DP3XX Manifold	3	3 gpm (11.36 lpm)	Flush 6.0 gals through cartridge(s) before use (flush approx. 2 mins.)	10,500 gallons (39,747 liters)
High Flow Series Single SF1XX Manifold	1	1 gpm (3.8 lpm)	Flush 2.0 gals through cartridge(s) before use (flush approx. 2 mins.)	3,500 gallons (13,249 liters)
High Flow Series DIDF2XX Manifold	2	2 gpm (7.57 lpm)	Flush 4.0 gals through cartridge(s) before use (flush approx. 2 mins.)	7,000 gallons (26,498 liters)

Performance Data Sheet

Model: High Flow Series/HF10-MS

Use Replacement Cartridge HF10-MS

The concentration of the indicated substances in water entering the system was reduced to a concentration less than or equal to the permissible limit for water leaving the system as specified in NSF/ANSI Standard 42, Standard 53 and CSA B483.1.



System tested and certified by NSF International against NSF/ANSI Standard 42, Standard 53, and CSA B483.1 for the reduction of substances as listed below.

Capacity: See chart on next page.
Contaminant Reduction Determined by NSF testing.

Substance Reduction	Average Influent	NSF/ANSI specified Challenge Concentration	Avg % Reduction	Average Product Water Concentration	Max Permissible Product Water Concentration	NSF Reduction Requirements	NSF Test Report
Particulate Class I, ≥ 0.5 to < 1.0 μm	4,833.333 pts/mL	At least 10,000 particles/mL	98.9%	52.167 pts/mL	N/A	$\geq 85\%$	J-00177426
Chlorine Taste and Odor	1.9 mg/L	2.0 mg/L $\pm 10\%$	97.4%	0.05 mg/L	N/A	$\geq 50\%$	J-00177390
Cyst Reduction*	87,000 cysts/L	Minimum 50,000 cysts/L	99.99%	4 cysts/L	N/A	$\geq 99.95\%$	J-00109556
Asbestos	10.1 MFL	10^7 to 10^8 fibers per liter	99%	0.17 MFL	N/A	$\geq 99\%$	J-00109555

*Based on the use of *Cryptosporidium parvum* oocysts.

FOR COMMERCIAL USE ONLY

Application Guidelines/Water Supply Parameters
Service Flow
Water Supply
Water Pressure
Water Temperature

See chart on next page
Potable Water
25 -125 psi (172 – 862 kPa)
40° F - 100° F (4.4° C - 38° C)
It is essential that the manufacturer's recommended installation, maintenance and filter replacement requirements be carried out for the product to perform as advertised. See Installation Manual for Warranty information.

Note: While the testing was performed under standard laboratory conditions, actual performance may vary.

Replacement Cartridge: HF10-MS For estimated costs of replacement elements please call 866.990.9785 or visit our website at www.3Mpurification.com

Parts and service available from:



3M Purification Inc.
400 Research Parkway
Menden, CT 06450, U.S.A.
Tel (866) 990-9785
(203) 237-5541
Fax (203) 238-8701
www.3Mpurification.com

3M is a trademark of 3M Company used under license.
© 2020 3M Company All rights reserved.
NSF is a trademark of NSF International



WARNING

Read entire manual. Failure to follow all guides and rules could cause personal injury or property damage.

- Check with your local public works department for plumbing codes. You must follow their guidelines as you install the water filtration system.
- Your water filtration system will withstand up to 125 pounds per square inch (psi) water pressure. If your house water supply pressure is higher than 80 psi, install a pressure reducing valve before installing the water filtration system.

To reduce the risk associated with the ingestion of contaminants:

- DO NOT use with water that is microbiologically unsafe or of unknown quality without adequate disinfection before or after the system. Systems certified for cyst reduction may be used on disinfected water that may contain filterable cysts.

NOTICE

To reduce the risk associated with water leakage or flooding:

- Read and follow Use instructions before installation and use of this system.
- Change the disposable filter cartridge at the recommended interval; the disposable filter cartridge MUST be replaced every 12 months or sooner.
- Failure to replace the disposable filter cartridge at recommended intervals may lead to reduced filter performance and failure of the filter, causing property damage from water leakage or flooding.

Performance Data Sheet
Model: High Flow Series/HF10-MS
 Use Replacement Cartridge HF10-MS

HF10-MS Cartridge Flow and Capacity Information

Head & Manifold	# of Cartridges	Flow Rate	Flush Instructions	Capacity
NH3 Series Head	1	1 gpm (3.8 lpm)	Flush 2.0 gals through cartridge(s) before use (flush approx. 2 mins.)	3,500 gallons (13,249 liters)
VH3 Series Head	1	1 gpm (3.8 lpm)	Flush 2.0 gals through cartridge(s) before use (flush approx. 2 mins.)	3,500 gallons (13,249 liters)
High Flow Series Twin 2XX Manifold	2	2 gpm (7.57 lpm)	Flush 4.0 gals through cartridge(s) before use (flush approx. 2 mins.)	7,000 gallons (26,498 liters)
High Flow Series Triple 3XX Manifold	3	3 gpm (11.36 lpm)	Flush 6.0 gals through cartridge(s) before use (flush approx. 2 mins.)	10,500 gallons (39,747 liters)
High Flow Series Single DP1XX Manifold	1	1 gpm (3.8 lpm)	Flush 2.0 gals through cartridge(s) before use (flush approx. 2 mins.)	3,500 gallons (13,249 liters)
High Flow Series Twin DP2XX Manifold	2	2 gpm (7.57 lpm)	Flush 4.0 gals through cartridge(s) before use (flush approx. 2 mins.)	7,000 gallons (26,498 liters)
High Flow Series Single DP1XX Manifold	1	1 gpm (3.8 lpm)	Flush 2.0 gals through cartridge(s) before use (flush approx. 2 mins.)	3,500 gallons (13,249 liters)
High Flow Series Twin DP2XX Manifold	2	2 gpm (7.57 lpm)	Flush 4.0 gals through cartridge(s) before use (flush approx. 2 mins.)	7,000 gallons (26,498 liters)
High Flow Series Triple DP3XX Manifold	3	3 gpm (11.36 lpm)	Flush 6.0 gals through cartridge(s) before use (flush approx. 2 mins.)	10,500 gallons (39,747 liters)
High Flow Series Single SF1XX Manifold	1	1 gpm (3.8 lpm)	Flush 2.0 gals through cartridge(s) before use (flush approx. 2 mins.)	3,500 gallons (13,249 liters)
High Flow Series DIDF2XX Manifold	2	2 gpm (7.57 lpm)	Flush 4.0 gals through cartridge(s) before use (flush approx. 2 mins.)	7,000 gallons (26,498 liters)

Performance Data Sheet

Model: High Flow Series/HF20, HF20-S and HF20-MS

Use Replacement Cartridge HF20, HF20-S, or HF20-MS
 The concentration of the indicated substances in water entering the system was reduced to a concentration less than or equal to the permissible limit for water leaving the system as specified in NSF/ANSI Standard 42, Standard 53 and CSA B483.1.



System tested and certified by NSF International against NSF/ANSI Standard 42, Standard 53 and CSA B483.1 for the reduction of substances as listed.

Capacity: See chart on next page.
 Contaminant Reduction Determined by NSF testing

Contaminant Reduction	Average Influent	NSF/ANSI specified Challenge Concentration	Avg % Reduction	Average Product Water Concentration	Max Permissible Product Water Concentration	NSF Reduction Requirements	NSF Test Report
Chlorine Taste and Odor	2.1 mg/L	2.0 mg/L ± 10%	96.6%	0.07 mg/L	N/A	≥ 50%	J-00210797
Nominal Particulate Class I, ≥ 0.5 µm to ≤ 1.0 µm	11,666,667 pts/mL	At least 10,000 particles/mL	99.8%	18,567 pts/mL	N/A	≥85%	J-00210878
Cyst*	145,000 cysts/L	Minimum 50,000 cysts/L	99.99%	1 cyst/L	N/A	≥99.95%	J-00210801

* Based on the use of *Cryptosporidium parvum* oocysts

FOR COMMERCIAL USE ONLY

Application Guidelines/Water Supply Parameters
Service Flow
Water Supply
Water Pressure
Water Temperature



Read entire manual. Failure to follow all guides and rules could cause personal injury or property damage.

- Check with your local public works department for plumbing codes. You must follow their guidelines as you install the water filtration system.
- Your water filtration system will withstand up to 125 pounds per square inch (psi) water pressure. If your house water supply pressure is higher than 80 psi, install a pressure reducing valve before installing the water filtration system.

To reduce the risk associated with the ingestion of contaminants:

- DO NOT use with water that is microbiologically unsafe or of unknown quality without adequate disinfection before or after the system. Systems certified for cyst reduction may be used on disinfected water that may contain filterable cysts.

NOTICE

To reduce the risk associated with water leakage or flooding:

- Read and follow Use Instructions before installation and use of this system.
- Change the disposable filter cartridge at the recommended interval; the disposable filter cartridge **MUST** be replaced every 12 months or sooner.
- Failure to replace the disposable filter cartridge at recommended intervals may lead to reduced filter performance and failure of the filter, causing property damage from water leakage or flooding.

It is essential that the manufacturer's recommended installation, maintenance and filter replacement requirements be carried out for the product to perform as advertised. See System Installation Manual for Warranty information.

Note: While the testing was performed under standard laboratory conditions, actual performance may vary.

Replacement Cartridge: HF20, HF20-S, or HF20-MS. For estimated costs of replacement elements please call 866.990.9785 or visit our website at www.3Mpurification.com

Parts and service available from:



3M Purification Inc.
 400 Research Parkway
 Meriden, CT 06450, U.S.A.
 Tel (866) 990-9785
 (203) 237-5541
 Fax (203) 238-8701
www.3Mpurification.com

3M is a trademark of 3M Company used under license.
 © 2020 3M Company. All rights reserved.
 NSF is a trademark of NSF International

Performance Data Sheet

Model: High Flow Series/HF20, HF20-S and HF20-MS

Use Replacement Cartridge HF20, HF20-S, or HF20-MS

HF20, HF20-S, or HF20-MS Cartridge Flow and Capacity Information

Head & Manifold	# of Cartridges	Flow Rate	Flush Instructions	Capacity
NH3 Series Head	1	1.5 gpm (5.67 lpm)	Flush 3.0 gals through cartridge(s) before use (flush approx. 2 mins.)	9,000 gallons (34,069 liters)
VH3 Series Head	1	1.5 gpm (5.67 lpm)	Flush 3.0 gals through cartridge(s) before use (flush approx. 2 mins.)	9,000 gallons (34,069 liters)
High Flow Series Twin 2XX Manifold	2	3.0 gpm (11.36 lpm)	Flush 6.0 gals through cartridge(s) before use (flush approx. 2 mins.)	18,000 gallons (68,137 liters)
High Flow Series Triple 3XX Manifold	3	4.5 gpm (17.03 lpm)	Flush 9.0 gals through cartridge(s) before use (flush approx. 2 mins.)	27,000 gallons (102,206 liters)
High Flow Series Single DF1XX Manifold	1	1.5 gpm (5.67 lpm)	Flush 3.0 gals through cartridge(s) before use (flush approx. 2 mins.)	9,000 gallons (34,069 liters)
High Flow Series Twin DF2XX Manifold	2	3.0 gpm (11.36 lpm)	Flush 6.0 gals through cartridge(s) before use (flush approx. 2 mins.)	18,000 gallons (68,137 liters)
High Flow Series Single DP1XX Manifold	1	1.5 gpm (5.67 lpm)	Flush 3.0 gals through cartridge(s) before use (flush approx. 2 mins.)	9,000 gallons (34,069 liters)
High Flow Series Twin DP2XX Manifold	2	3.0 gpm (11.36 lpm)	Flush 6.0 gals through cartridge(s) before use (flush approx. 2 mins.)	18,000 gallons (68,137 liters)
High Flow Series Triple DP3XX Manifold	3	4.5 gpm (17.03 lpm)	Flush 9.0 gals through cartridge(s) before use (flush approx. 2 mins.)	27,000 gallons (102,206 liters)
High Flow Series Single SF1XX Manifold	1	1.5 gpm (5.67 lpm)	Flush 3.0 gals through cartridge(s) before use (flush approx. 2 mins.)	9,000 gallons (34,069 liters)
High Flow Series DIDF2XX Manifold	2	3.0 gpm (11.36 lpm)	Flush 6.0 gals through cartridge(s) before use (flush approx. 2 mins.)	18,000 gallons (68,137 liters)

Performance Data Sheet

Model: High Flow Series/ HF25, HF25-S and HF25-MS

Use Replacement Cartridge HF25, HF25-S or HF25-MS



System tested and certified by NSF International against NSF/ANSI Standard 42 and CSA B483.1 for the reduction of substances as listed below.

The concentration of the indicated substances in water entering the system was reduced to a concentration less than or equal to the permissible limit for water leaving the system as specified in NSF/ANSI Standard 42 and CSA B483.1.

Capacity: See chart on next page.
Contaminant Reduction Determined by NSF Testing.

Substance Reduction	Average Influent	NSF/ANSI specified Challenge Concentration	Avg % Reduction	Average Product Water Concentration	Max Permissible Product Water Concentration	NSF Reduction Requirements	NSF Test Report
Chlorine Taste and Odor	1.9 mg/L	2.0 mg/L \pm 10%	93.1%	0.14 mg/L	N/A	\geq 50%	J-00177378
Nominal Particulate Class I, \leq 0.5 μ m to \leq 1.0 μ m	4,333,333 pts/mL	At least 10,000 particles/mL	99.2%	32,667 pts/mL	N/A	\geq 85%	J-00210878

FOR COMMERCIAL USE ONLY

Application Guidelines/Water Supply Parameters
Service Flow
Water Supply
Water Pressure
Water Temperature

See chart on next page
Potable Water
25 - 125 psi (172 - 862 kPa)
40° F - 100° F (4.4° C - 38° C)

It is essential that the manufacturer's recommended installation, maintenance and filter replacement requirements be carried out for the product to perform as advertised. See System Installation Manual for Warranty information.

Note: While the testing was performed under standard laboratory conditions, actual performance may vary.

Replacement Cartridge: HF25, HF25-S and HF25-MS. For estimated costs of replacement elements please call 866.990.9785 or visit our website at www.3Mpurification.com

Parts and service available from:



3M Purification Inc.
400 Research Parkway
Meriden, CT 06450, U.S.A.
Tel: (866) 990-9785
(203) 237-5541
Fax: (203) 238-8701
www.3Mpurification.com

3M is a trademark of 3M Company used under license.
© 2020 3M Company. All rights reserved.
NSF is a trademark of NSF International



WARNING

Read entire manual. Failure to follow all guides and rules could cause personal injury or property damage.

- Check with your local public works department for plumbing codes. You must follow their guidelines as you install the water filtration system.
- Your water filtration system will withstand up to 125 pounds per square inch (psi) water pressure. If your house water supply pressure is higher than 80 psi, install a pressure reducing valve before installing the water filtration system.

To reduce the risk associated with the ingestion of contaminants:

- DO NOT use with water that is microbiologically unsafe or of unknown quality without adequate disinfection before or after the system.

NOTICE

To reduce the risk associated with water leakage or flooding:

- Read and follow Use Instructions before installation and use of this system.
- Change the disposable filter cartridge at the recommended interval; the disposable filter cartridge **MUST** be replaced every 12 months or sooner.
- Failure to replace the disposable filter cartridge at recommended intervals may lead to reduced filter performance and failure of the filter, causing property damage from water leakage or flooding.

Performance Data Sheet
Model: High Flow Series/ HF25, HF25-S and HF25-MS
 Use Replacement Cartridge HF25, HF25-S or HF25-MS

HF25, HF25-S and HF25-MS Cartridge Flow and Capacity Information

Head & Manifold	# of Cartridges	Flow Rate	Flush Instructions	Capacity
NH3 Series Head	1	1.5 gpm (5.67 lpm)	Flush 3.0 gals through cartridge(s) before use (flush approx. 2 mins.)	10,000 gallons (37,854 liters)
VH3 Series Head	1	1.5 gpm (5.67 lpm)	Flush 3.0 gals through cartridge(s) before use (flush approx. 2 mins.)	10,000 gallons (37,854 liters)
High Flow Series Twin 2XX Manifold	2	3.0 gpm (11.36 lpm)	Flush 6.0 gals through cartridge(s) before use (flush approx. 2 mins.)	20,000 gallons (75,708 liters)
High Flow Series Triple 3XX Manifold	3	4.5 gpm (17.03 lpm)	Flush 9.0 gals through cartridge(s) before use (flush approx. 2 mins.)	30,000 gallons (113,562 liters)
High Flow Series Single DF-1XX Manifold	1	1.5 gpm (5.67 lpm)	Flush 3.0 gals through cartridge(s) before use (flush approx. 2 mins.)	10,000 gallons (37,854 liters)
High Flow Series Twin DF2XX Manifold	2	3.0 gpm (11.36 lpm)	Flush 6.0 gals through cartridge(s) before use (flush approx. 2 mins.)	20,000 gallons (75,708 liters)
High Flow Series Single DP-1XX Manifold	1	1.5 gpm (5.67 lpm)	Flush 3.0 gals through cartridge(s) before use (flush approx. 2 mins.)	10,000 gallons (37,854 liters)
High Flow Series Twin DP2XX Manifold	2	3.0 gpm (11.36 lpm)	Flush 6.0 gals through cartridge(s) before use (flush approx. 2 mins.)	20,000 gallons (75,708 liters)
High Flow Series Triple DP3XX Manifold	3	4.5 gpm (17.03 lpm)	Flush 9.0 gals through cartridge(s) before use (flush approx. 2 mins.)	30,000 gallons (113,562 liters)
High Flow Series Single SF-1XX Manifold	1	1.5 gpm (5.67 lpm)	Flush 3.0 gals through cartridge(s) before use (flush approx. 2 mins.)	10,000 gallons (37,854 liters)
High Flow Series DIDF2XX Manifold	2	3.0 gpm (11.36 lpm)	Flush 6.0 gals through cartridge(s) before use (flush approx. 2 mins.)	20,000 gallons (75,708 liters)

Performance Data Sheet

Model: High Flow Series/HF30, HF30-S and HF30-MS

Use Replacement Cartridge HF30, HF30-S or HF30-MS

The concentration of the indicated substances in water entering the system was reduced to a concentration less than or equal to the permissible limit for water leaving the system as specified in NSF/ANSI Standard 42, Standard 53 and CSA B483.1.



System tested and certified by NSF International against NSF/ANSI Standard 42, Standard 53 and CSA B483.1 for the reduction of substances as listed below.

Capacity: See chart on next page.
Contaminant Reduction: Determined by NSF testing.

Substance Reduction	Average Influent	NSF/ANSI specified Challenge Concentration	Avg % Reduction	Average Product Water Concentration	Max Permissible Product Water Concentration	NSF Reduction Requirements	NSF Test Report
Chlorine Taste and Odor	2.0 mg/L	2.0 mg/L ± 10%	97.5%	0.05 mg/L	N/A	≥ 50%	J-00177380
Nominal Particulate Class I, ≥ 0.5 µm to ≤ 1.0 µm	4,333-333 pt/mL	At least 10,000 particles/mL	99.2%	32,667 pt/mL	N/A	≥ 85%	J-00177428
Cyst*	97,500 cysts/L	Minimum 50,000 cysts/L	>99.99%	13 cyst/L	N/A	≥ 99.95%	J-00124427
Turbidity	11.8 NTU	11 ± 1 NTU	98.8	0.13 NTU	0.5 NTU	N/A	J-00029891

*Based on the use of Cryptosporidium parvum oocysts

FOR COMMERCIAL USE ONLY

Application Guidelines/Water Supply Parameters
Service Flow
Water Supply
Water Pressure
Water Temperature

See chart on next page

Potable Water

25-125 psi (1.72 – 862 kPa)

40° F - 100° F (4.4° C - 38° C)

It is essential that the manufacturer's recommended installation, maintenance and filter replacement requirements be carried out for the product to perform as advertised. See System Installation Manual for Warranty information.

Note: While the testing was performed under standard laboratory conditions, actual performance may vary.

Replacement Cartridge: HF30, HF30-S or HF30-MS. For estimated costs of replacement elements please call 866-990-9785 or visit our website at www.3Mpurification.com

Parts and service available from:



3M Purification Inc.
400 Research Parkway
Meriden, CT 06450, U.S.A.
Tel (866) 990-9785
(203) 237-5541
Fax (203) 238-8701
www.3Mpurification.com

3M is a trademark of 3M Company used under license.
© 2020 3M Company. All rights reserved.
NSF is a trademark of NSF International

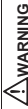

WARNING

Read entire manual. Failure to follow all guides and rules could cause personal injury or property damage.

- Check with your local public works department for plumbing codes. You must follow their guidelines as you install the water filtration system.
- Your water filtration system will withstand up to 125 pounds per square inch (psi) water pressure. If your house water supply pressure is higher than 80 psi, install a pressure reducing valve before installing the water filtration system.

To reduce the risk associated with the ingestion of contaminants:

- DO NOT use with water that is microbiologically unsafe or of unknown quality without adequate disinfection before or after the system. Systems certified for cyst reduction may be used on disinfected water that may contain filterable cysts.

NOTICE

To reduce the risk associated with water leakage or flooding:

- Read and follow Use Instructions before installation and use of this system.
- Change the disposable filter cartridge at the recommended interval; the disposable filter cartridge MUST be replaced every 12 months or sooner.
- Failure to replace the disposable filter cartridge at recommended intervals may lead to reduced filter performance and failure of the filter, causing property damage from water leakage or flooding.

Performance Data Sheet
Model: High Flow Series/HF30, HF30-S and HF30-MS
 Use Replacement Cartridge HF30, HF30-S or HF30-MS

HF30, HF30-S and HF30-MS Cartridge Flow and Capacity Information

Head & Manifold	# of Cartridges	Flow Rate	Flush Instruction	Capacity
NH3 Series Head	1	1.67 gpm (6.32 lpm)	Flush 3.34 gals through cartridge(s) before use (flush approx. 2 mins.)	14,000 gallons (52,996 liters)
VH3 Series Head	1	1.67 gpm (6.32 lpm)	Flush 3.34 gals through cartridge(s) before use (flush approx. 2 mins.)	14,000 gallons (52,996 liters)
High Flow Series Twin 2XX Manifold	2	3.34 gpm (12.64 liters)	Flush 7.0 gals through cartridge(s) before use (flush approx. 2 mins.)	28,000 gallons (105,992 liters)
High Flow Series Triple 3XX Manifold	3	5.01 gpm (18.96 liters)	Flush 10.0 gals through cartridge(s) before use (flush approx. 2 mins.)	42,000 gallons (158,987 liters)
High Flow Series Single DF1XX Manifold	1	1.67 gpm (6.32 lpm)	Flush 3.34 gals through cartridge(s) before use (flush approx. 2 mins.)	14,000 gallons (52,996 liters)
High Flow Series Twin DF2XX Manifold	2	3.34 gpm (12.64 liters)	Flush 7.0 gals through cartridge(s) before use (flush approx. 2 mins.)	28,000 gallons (105,992 liters)
High Flow Series Single DP1XX Manifold	1	1.67 gpm (6.32 lpm)	Flush 3.34 gals through cartridge(s) before use (flush approx. 2 mins.)	14,000 gallons (52,996 liters)
High Flow Series Twin DP2XX Manifold	2	3.34 gpm (12.64 liters)	Flush 7.0 gals through cartridge(s) before use (flush approx. 2 mins.)	28,000 gallons (105,992 liters)
High Flow Series Triple DP3XX Manifold	3	5.01 gpm (18.96 liters)	Flush 10.0 gals through cartridge(s) before use (flush approx. 2 mins.)	42,000 gallons (158,987 liters)
High Flow Series Single SF1XX Manifold	1	1.67 gpm (6.32 lpm)	Flush 3.34 gals through cartridge(s) before use (flush approx. 2 mins.)	14,000 gallons (52,996 liters)
High Flow Series DIDF2XX Manifold	2	3.34 gpm (12.64 liters)	Flush 7.0 gals through cartridge(s) before use (flush approx. 2 mins.)	28,000 gallons (105,992 liters)

Performance Data Sheet

Model: High Flow Series/HF35-CL

Use Replacement Cartridge HF35-CL

The concentration of the indicated substances in water entering the system was reduced to a concentration less than or equal to the permissible limit for water leaving the system as specified in NSF/ANSI Standard 42 and CSA B483.1.



System tested and certified by NSF International against NSF/ANSI Standard 42 and CSA B483.1 for the reduction of substances as listed below.

Capacity: See chart on next page.
Contaminant Reduction: Determined by NSF Testing.

Contaminant Reduction	Average Influent	NSF/ANSI specified Challenge Concentration	Avg % Reduction	Average Product Water Concentration	Max Permissible Product Water Concentration	NSF/ANSI Requirements	NSF Test Report
Chlorine Taste and Odor	2.0 mg/L	2.0 mg/L ± 10%	96.6%	0.19 mg/L	N/A	≥ 50%	J-00119093
Chloramine	3.0 mg/L	3.0 mg/L ± 10%	96.6%	0.10 mg/L	<0.5 mg/L	N/A	J-00119093

FOR COMMERCIAL USE ONLY

Application Guidelines/Water Supply Parameters

Service Flow	See chart on next page
Water Supply	Potable Water
Water Pressure	25 -125 psi (172 - 862 kPa)
Water Temperature	40° F - 100° F (4.4° C - 38° C)

It is essential that the manufacturer's recommended installation, maintenance and filter replacement requirements be carried out for the product to perform as advertised. See System Installation Manual for Warranty information.

Note: While the testing was performed under standard laboratory conditions, actual performance may vary.

Replacement Cartridge: HF35-CL. For estimated costs of replacement elements please call 866.990.9785 or visit our website at www.3mpurification.com

Parts and service available from:



3M Purification Inc.
400 Research Parkway
Meriden, CT 06450, U.S.A.
Tel (866) 990-9785
(203) 237-5541
Fax (203) 238-8701
www.3mpurification.com

3M is a trademark of 3M Company used under license.
© 2020 3M Company. All rights reserved.
NSF is a trademark of NSF International



WARNING

Read entire manual. Failure to follow all guides and rules could cause personal injury or property damage.

- Check with your local public works department for plumbing codes. You must follow their guidelines as you install the water filtration system.
- Your water filtration system will withstand up to 125 pounds per square inch (psi) water pressure. If your house water supply pressure is higher than 80 psi, install a pressure reducing valve before installing the water filtration system.

To reduce the risk associated with the ingestion of contaminants:

- DO NOT use with water that is microbiologically unsafe or of unknown quality without adequate disinfection before or after the system.

NOTICE

To reduce the risk associated with water leakage or flooding:

- Read and follow Use instructions before installation and use of this system.
- Change the disposable filter cartridge at the recommended interval; the disposable filter cartridge MUST be replaced every 12 months or sooner.
- Failure to replace the disposable filter cartridge at recommended intervals may lead to reduced filter performance and failure of the filter, causing property damage from water leakage or flooding.

Performance Data Sheet
Model: High Flow Series/HF35-CL
 Use Replacement Cartridge HF35-CL

HF35-CL Cartridge Flow and Capacity Information

Head & Manifold	# of Cartridges	Flow Rate	Flush Instructions	Capacity
NH3 Series Head	1	1.67 gpm (6.3 lpm)	Flush 3.34 gals through cartridge(s) before use (flush approx. 2 mins.)	3,600 gallons (13,626 liters)
VH3 Series Head	1	1.67 gpm (6.3 lpm)	Flush 3.34 gals through cartridge(s) before use (flush approx. 2 mins.)	3,600 gallons (13,626 liters)
High Flow Series Twin 2XX Manifold	2	3.34 gpm (12.6 lpm)	Flush 7.0 gals through cartridge(s) before use (flush approx. 2 mins.)	7200 gallons (27,252 liters)
High Flow Series Triple 3XX Manifold	3	5.01 gpm (19.0 lpm)	Flush 10.0 gals through cartridge(s) before use (flush approx. 2 mins.)	10,800 gallons (40,878 liters)
High Flow Series Single DF1XX Manifold	1	1.67 gpm (6.3 lpm)	Flush 3.34 gals through cartridge(s) before use (flush approx. 2 mins.)	3,600 gallons (13,626 liters)
High Flow Series Twin DF2XX Manifold	2	3.34 gpm (12.6 lpm)	Flush 7.0 gals through cartridge(s) before use (flush approx. 2 mins.)	7200 gallons (27,252 liters)
High Flow Series Single DP1XX Manifold	1	1.67 gpm (6.3 lpm)	Flush 3.34 gals through cartridge(s) before use (flush approx. 2 mins.)	3,600 gallons (13,626 liters)
High Flow Series Twin DP2XX Manifold	2	3.34 gpm (12.6 lpm)	Flush 7.0 gals through cartridge(s) before use (flush approx. 2 mins.)	7200 gallons (27,252 liters)
High Flow Series Triple D3PXX Manifold	3	5.01 gpm (19.0 lpm)	Flush 10.0 gals through cartridge(s) before use (flush approx. 2 mins.)	10,800 gallons (40,878 liters)
High Flow Series Single SF1XX Manifold	1	1.67 gpm (6.3 lpm)	Flush 3.34 gals through cartridge(s) before use (flush approx. 2 mins.)	3,600 gallons (13,626 liters)
High Flow Series DIDF2XX Manifold	2	3.34 gpm (12.6 lpm)	Flush 7.0 gals through cartridge(s) before use (flush approx. 2 mins.)	7200 gallons (27,252 liters)

Performance Data Sheet

Model: High Flow Series/HF35, HF35-S and HF35-MS

Use Replacement Cartridge HF35, HF35-S or HF35-MS

The concentration of the indicated substances in water entering the system was reduced to a concentration less than or equal to the permissible limit for water leaving the system as specified in NSF/ANSI Standard 42 and CSA B483.1.



System tested and certified by NSF International against NSF/ANSI Standard 42 and CSA B483.1 for the reduction of substances as listed below.

Capacity: See chart on next page.

Contaminant Reduction Determined by NSF Testing.

Contaminant Reduction	Average Influent	NSF/ANSI specified Challenge Concentration	Avg % Reduction	Average Product Water Concentration	Max Permissible Product Water Concentration	NSF/ANSI Reduction Requirements	NSF Test Report
Chlorine Taste and Odor	1.9 mg/L	2.0 mg/L ± 10%	95.7%	0.08 mg/L	N/A	≥ 50%	J-00177384
Nominal Particulate Class I, ≥0.5 to < 1.0 µm	7,686,667 pts/mL	At least 10,000 particles/mL	99.9%	1392 pts/mL	N/A	≥85%	J-00100653

FOR COMMERCIAL USE ONLY

Application Guidelines/Water Supply Parameters

Service Flow	See chart on next page
Water Supply	Potable Water
Water Pressure	25 - 125 psi (172 - 862 kPa)
Water Temperature	40° F - 100° F (4.4° C - 38° C)

It is essential that the manufacturer's recommended installation, maintenance and filter replacement requirements be carried out for the product to perform as advertised. See System Installation Manual for Warranty information.

Note: While the testing was performed under standard laboratory conditions, actual performance may vary.

Replacement Cartridge: HF35, HF35-S or HF35-MS. For estimated costs of replacement elements please call 866.990.9785 or visit our website at www.3Mpurification.com

Parts and service available from:



3M Purification Inc.
 400 Research Parkway
 Meriden, CT 06450, U.S.A.
 Tel: (866) 990-9785
 (203) 237-5541
 Fax: (203) 238-8701
www.3Mpurification.com

3M is a trademark of 3M Company used under license.
 © 2020 3M Company. All rights reserved.
 NSF is a trademark of NSF International

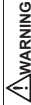

WARNING
 Read entire manual. Failure to follow all guides and rules could cause personal injury or property damage.

- Check with your local public works department for plumbing codes. You must follow their guidelines as you install the water filtration system.
- Your water filtration system will withstand up to 125 pounds per square inch (psi) water pressure. If your house water supply pressure is higher than 80 psi, install a pressure reducing valve before installing the water filtration system.

To reduce the risk associated with the ingestion of contaminants:

- DO NOT use with water that is microbiologically unsafe or of unknown quality without adequate disinfection before or after the system.

NOTICE

To reduce the risk associated with water leakage or flooding:

- Read and follow Use Instructions before installation and use of this system.
- Change the disposable filter cartridge at the recommended interval; the disposable filter cartridge **MUST** be replaced every 12 months or sooner.
- Failure to replace the disposable filter cartridge at recommended intervals may lead to reduced filter performance and failure of the filter, causing property damage from water leakage or flooding.

Performance Data Sheet

Model: High Flow Series/HF35, HF35-S and HF35-MS

Use Replacement Cartridge HF35, HF35-S or HF35-MS

HF35, HF35-S and HF35-MS Cartridge Flow and Capacity Information

Head & Manifold	# of Cartridges	Flow Rate	Flush Instructions	Capacity
NH3 Series Head	1	1.67 gpm (6.3 lpm)	Flush 3.34 gals through cartridge(s) before use (flush approx. 2 mins.)	12,600 gallons (47,696 liters)
VH3 Series Head	1	1.67 gpm (6.3 lpm)	Flush 3.34 gals through cartridge(s) before use (flush approx. 2 mins.)	12,600 gallons (47,696 liters)
High Flow Series Twin 2XX Manifold	2	3.34 gpm (12.6 lpm)	Flush 7.0 gals through cartridge(s) before use (flush approx. 2 mins.)	25,200 gallons (95,392 liters)
High Flow Series Triple 3XX Manifold	3	5.01 gpm (19.0 lpm)	Flush 10.0 gals through cartridge(s) before use (flush approx. 2 mins.)	37,800 gallons (143,089 liters)
High Flow Series Single DF1XX Manifold	1	1.67 gpm (6.3 lpm)	Flush 3.34 gals through cartridge(s) before use (flush approx. 2 mins.)	12,600 gallons (47,696 liters)
High Flow Series Twin DF2XX Manifold	2	3.34 gpm (12.6 lpm)	Flush 7.0 gals through cartridge(s) before use (flush approx. 2 mins.)	25,200 gallons (95,392 liters)
High Flow Series Single DP1XX Manifold	1	1.67 gpm (6.3 lpm)	Flush 3.34 gals through cartridge(s) before use (flush approx. 2 mins.)	12,600 gallons (47,696 liters)
High Flow Series Twin DP2XX Manifold	2	3.34 gpm (12.6 lpm)	Flush 7.0 gals through cartridge(s) before use (flush approx. 2 mins.)	25,200 gallons (95,392 liters)
High Flow Series Triple DP3XX Manifold	3	5.01 gpm (19.0 lpm)	Flush 10.0 gals through cartridge(s) before use (flush approx. 2 mins.)	37,800 gallons (143,089 liters)
High Flow Series Single SF1XX Manifold	1	1.67 gpm (6.3 lpm)	Flush 3.34 gals through cartridge(s) before use (flush approx. 2 mins.)	12,600 gallons (47,696 liters)
High Flow Series DIDF2XX Manifold	2	3.34 gpm (12.6 lpm)	Flush 7.0 gals through cartridge(s) before use (flush approx. 2 mins.)	25,200 gallons (95,392 liters)

Performance Data Sheet

Model: HF20-I and HF20-SI

Use Replacement Cartridge: **HF20-I or HF20-SI**

The concentration of the indicated substances in water entering the system was reduced to a concentration less than or equal to the permissible limit for water leaving the system as specified in NSF/ANSI Standard 42, Standard 53 and CSA B483.1.



System tested and certified by NSF International against NSF/ANSI Standard 42, Standard 53 and CSA B483.1 for the reduction of substances as listed.

Capacity 14,000 Gallons (52,995 Liters)		Contaminant Reduction Determined by NSF testing.		NSF Test Report		
Substance Reduction	Average Influent	NSF specified Challenge Concentration	Avg % Reduction	Max Permissible Product Water Concentration	NSF Reduction Requirements	NSF Test Report
Particulate Class I, ≥0.5 to <1.0 µm	1,053,333 pps/mL	At least 10,000 pps/mL	99.8%	1492 pps/mL	≥ 85%	J-00267164
Chlorine Taste and Odor	2.0 mg/L	2.0 mg/L ± 10%	93.0%	0.14 mg/L	≥ 50%	J-00363040
Cyst Reduction*	120,000 cysts/L	Minimum 50,000 cysts/L	99.99%	1 cyst/L	99.95%	J-00267166

* Based on the use of *Cryptosporidium parvum* oocysts

FOR COMMERCIAL USE ONLY

Application Guidelines/Water Supply Parameters	
Service Flow	1.67 gpm (6.32 lpm)
Water Supply	Potable Water
Water Pressure	25-125 psi (206 – 862 kPa)
Water Temperature	40° F - 100° F (4.4° C - 38° C)

It is essential that the manufacturer's recommended installation, maintenance and filter replacement requirements be carried out for the product to perform as advertised. See System Installation Manual for Warranty information.

Note: While the testing was performed under standard laboratory conditions, actual performance may vary.

Replacement Cartridge: HF20-I or HF20-SI. For estimated costs of replacement elements please call 866.990.9785 or visit our website at www.3mpurification.com

Parts and service available from:



3M Purification Inc.
 400 Research Parkway
 Meriden, CT 06450, U.S.A.
 Tel (603) 222-7880
 (203) 237-5541
 Fax (203) 238-8701
www.3mpurification.com

3M is a trademark of 3M Company used under license.
 © 2019 3M Company. All rights reserved.
 NSF is a trademark of NSF International



WARNING

To reduce the risk associated with ingestion of contaminants:

- Do not use with water that is microbiologically unsafe or of unknown quality without adequate disinfection before and after the system. Systems certified for cyst reduction may be used on disinfected water that may contain filterable cysts.

Read entire manual. Failure to follow all guides and rules could cause personal injury or property damage.

- Check with your local public works department for plumbing codes. You must follow their guidelines as you install the water filtration system.
- Your water filtration system will withstand up to 125 pounds per square inch (psi) water pressure. If your water supply pressure is higher than 80 psi, install a pressure reducing valve before installing the water filtration system.

NOTICE

To reduce the risk associated with property damage due to water leakage or flooding:

- Read and follow all instructions before installation and use of this system.
- Change the disposable filter cartridge at the recommended interval; the disposable filter cartridge **MUST** be replaced every 6 months or sooner
- Failure to replace the disposable filter cartridge at recommended intervals may lead to reduced filter performance and failure of the filter, causing property damage from water leakage or flooding.

IMPORTANT: Flush at least 3.34 gallons through cartridge before use (flush approximately 2 minutes).



Performance Data Sheet

Model: High Flow Series/HF40 and HF40-S

Use Replacement Cartridge HF40 or HF40-S
 The concentration of the indicated substances in water entering the system was reduced to a concentration less than or equal to the permissible limit for water leaving the system as specified in NSF/ANSI Standard 42, Standard 53 and CSA B483.1.



System tested and certified by NSF International against NSF/ANSI Standard 42, Standard 53 and CSA B483.1 for the reduction of substances as listed below.

Capacity: See chart on next page.
 Contaminant Reduction: Determined by NSF testing.

Substance Reduction	Average Influent	NSF/ANSI specified Challenge Concentration	Avg % Reduction	Average Product Water Concentration	Max Permissible Product Water Concentration	NSF/ANSI Requirements	NSF Test Report
Chlorine Taste and Odor	1.9 mg/L	2.0 mg/L ± 10%	96.8%	0.06 mg/L	N/A	≥ 50%	J-00215320
Nominal Particulate Class I, ≥ 0.5 µm to ≤ 1.0 µm	4,066,667 pbs/mL	At least 10,000 particles/mL	99.9%	2665 pbs/mL	N/A	≥ 85%	J-00125785
Cyst*	120,000 cysts/L	Minimum 50,000 cysts/L	99.98%	13 cysts/L	N/A	≥ 99.95%	J-00125784

* Based on the use of *Cryptosporidium parvum* oocysts

FOR COMMERCIAL USE ONLY

Application Guidelines/Water Supply Parameters	
Service Flow	See chart on next page
Water Supply	Potable Water
Water Pressure	25 - 125 psi (172 - 862 kPa)
Water Temperature	40° F - 100° F (4.4° C - 38° C)

It is essential that the manufacturer's recommended installation, maintenance and filter replacement requirements be carried out for the product to perform as advertised. See System Installation Manual for Warranty information.

Note: While the testing was performed under standard laboratory conditions, actual performance may vary.

Replacement Cartridge: HF40 or HF40-S. For estimated costs of replacement elements please call 866.990.9785 or visit our website at www.3Mpurification.com.

Parts and service available from:



3M Purification Inc.
 400 Research Parkway
 Meriden, CT 06450, U.S.A.
 Tel (866) 990-9785
 (203) 237-5541
 Fax (203) 238-8701
www.3Mpurification.com

3M is a trademark of 3M Company used under license.
 © 2020 3M Company. All rights reserved.
 NSF is a trademark of NSF International



WARNING

Read entire manual. Failure to follow all guides and rules could cause personal injury or property damage.

- Check with your local public works department for plumbing codes. You must follow their guidelines as you install the water filtration system.
- Your water filtration system will withstand up to 125 pounds per square inch (psi) water pressure. If your house water supply pressure is higher than 80 psi, install a pressure reducing valve before installing the water filtration system.

To reduce the risk associated with the ingestion of contaminants:

- DO NOT use with water that is microbiologically unsafe or of unknown quality without adequate disinfection before or after the system. Systems certified for cyst reduction may be used on disinfected water that may contain filterable cysts.

NOTICE

To reduce the risk associated with water leakage or flooding:

- Read and follow Use Instructions before installation and use of this system.
- Change the disposable filter cartridge at the recommended interval; the disposable filter cartridge MUST be replaced every 12 months or sooner.
- Failure to replace the disposable filter cartridge at recommended intervals may lead to reduced filter performance and failure of the filter, causing property damage from water leakage or flooding.

Performance Data Sheet
Model: High Flow Series/HF40 and HF40-S
 Use Replacement Cartridge HF40 or HF40-S

HF40 and HF40-S Cartridge Flow and Capacity Information

Head & Manifold	# of Cartridges	Flow Rate	Flush Instruction	Capacity
NH3 Series Head	1	2.5 gpm (9.5 lpm)	Flush 5.0 gals through cartridge(s) before use (flush approx. 2 mins.)	25,000 gallons (94,635 liters)
VH3 Series Head	1	2.5 gpm (9.5 lpm)	Flush 5.0 gals through cartridge(s) before use (flush approx. 2 mins.)	25,000 gallons (94,635 liters)
High Flow Series Twin 2XX Manifold	2	5.0 gpm (19.0 lpm)	Flush 10.0 gals through cartridge(s) before use (flush approx. 2 mins.)	50,000 gallons (189,270 liters)
High Flow Series Triple 3XX Manifold	3	7.5 gpm (28.4 lpm)	Flush 15 gals through cartridge(s) before use (flush approx. 2 mins.)	75,000 gallons (283,905 liters)
High Flow Series Single DF-1XX Manifold	1	2.5 gpm (9.5 lpm)	Flush 5.0 gals through cartridge(s) before use (flush approx. 2 mins.)	25,000 gallons (94,635 liters)
High Flow Series Twin DF-2XX Manifold	2	5.0 gpm (19.0 lpm)	Flush 10.0 gals through cartridge(s) before use (flush approx. 2 mins.)	50,000 gallons (189,270 liters)
High Flow Series Single DP-1XX Manifold	1	2.5 gpm (9.5 lpm)	Flush 5.0 gals through cartridge(s) before use (flush approx. 2 mins.)	25,000 gallons (94,635 liters)
High Flow Series Twin DP-2XX Manifold	2	5.0 gpm (19.0 lpm)	Flush 10.0 gals through cartridge(s) before use (flush approx. 2 mins.)	50,000 gallons (189,270 liters)
High Flow Series Triple DP-3XX Manifold	3	7.5 gpm (28.4 lpm)	Flush 15.0 gals through cartridge(s) before use (flush approx. 2 mins.)	75,000 gallons (283,905 liters)
High Flow Series Single SF-1XX Manifold	1	2.5 gpm (9.5 lpm)	Flush 5.0 gals through cartridge(s) before use (flush approx. 2 mins.)	25,000 gallons (94,635 liters)
High Flow Series DIDF-2XX Manifold	2	5.0 gpm (19.0 lpm)	Flush 10.0 gals through cartridge(s) before use (flush approx. 2 mins.)	50,000 gallons (189,270 liters)

Performance Data Sheet

Model: High Flow Series/HF45 and HF45-S

Use Replacement Cartridge HF45 or HF45-S



System tested and certified by NSF International against NSF/ANSI Standard 42 and CSA B483.1 for the reduction of substances as listed below.

The concentration of the indicated substances in water entering the system was reduced to a concentration less than or equal to the permissible limit for water leaving the system as specified in NSF/ANSI Standard 42 and CSA B483.1.

Capacity: See chart on next page.
Contaminant Reduction Determined by NSF testing.

Substance Reduction	Average Influent	NSF/ANSI specified Challenge Concentration	Avg % Reduction	Average Product Water Concentration	Max Permissible Product Water Concentration	NSF Reduction Requirements	NSF Test Report
Chlorine Taste and Odor	2.0 mg/L	2.0 mg/L ± 10%	97.5%	0.05 mg/L	N/A	≥ 50%	J-00089385

FOR COMMERCIAL USE ONLY

Application Guidelines/Water Supply Parameters
Service Flow
Water Supply
Water Pressure
Water Temperature

It is essential that the manufacturer's recommended installation, maintenance and filter replacement requirements be carried out for the product to perform as advertised. See System Installation Manual for Warranty information.

Note: While the testing was performed under standard laboratory conditions, actual performance may vary.

Replacement Cartridge: HF45 or HF45-S. For estimated costs of replacement elements please call 866.990.9785 or visit our website at www.3Mpurification.com

Parts and service available from:



3M Purification Inc.
400 Research Parkway
Menden, CT 06450, U.S.A.
Tel (866) 990-9785
(203) 237-5541
Fax (203) 238-8701
www.3Mpurification.com

3M is a trademark of 3M Company used under license.
© 2020 3M Company. All rights reserved.
NSF is a trademark of NSF International



Read entire manual. Failure to follow all guides and rules could cause personal injury or property damage.

- Check with your local public works department for plumbing codes. You must follow their guidelines as you install the water filtration system.
- Your water filtration system will withstand up to 125 pounds per square inch (psi) water pressure. If your house water supply pressure is higher than 80 psi, install a pressure reducing valve before installing the water filtration system.

To reduce the risk associated with the ingestion of contaminants:

- DO NOT use with water that is microbiologically unsafe or of unknown quality without adequate disinfection before or after the system.

NOTICE

To reduce the risk associated with water leakage or flooding:

- Read and follow Use Instructions before installation and use of this system.
- Change the disposable filter cartridge at the recommended interval; the disposable filter cartridge MUST be replaced every 12 months or sooner.
- Failure to replace the disposable filter cartridge at recommended intervals may lead to reduced filter performance and failure of the filter, causing property damage from water leakage or flooding.

Performance Data Sheet
Model: High Flow Series/HF45 and HF45-S
 Use Replacement Cartridge HF45 or HF45-S

HF45 and HF45-S Cartridge Flow and Capacity Information

Head & Manifold	# of Cartridges	Flow Rate	Flush Instructions	Capacity
NH3 Series Head	1	2.1 gpm (7.9 lpm)	Flush 5.0 gals through cartridge(s) before use (flush approx. 2 mins.)	25,000 gallons (94,635 liters)
VH3 Series Head	1	2.1 gpm (7.9 lpm)	Flush 5.0 gals through cartridge(s) before use (flush approx. 2 mins.)	25,000 gallons (94,635 liters)
High Flow Series Twin 2XX Manifold	2	4.2 gpm (15.9 lpm)	Flush 10.0 gals through cartridge(s) before use (flush approx. 2 mins.)	50,000 gallons (189,271 liters)
High Flow Series Triple 3XX Manifold	3	6.3 gpm (23.8 lpm)	Flush 15 gals through cartridge(s) before use (flush approx. 2 mins.)	75,000 gallons (283,906 liters)
High Flow Series Single DF1XX Manifold	1	2.1 gpm (7.9 lpm)	Flush 5.0 gals through cartridge(s) before use (flush approx. 2 mins.)	25,000 gallons (94,635 liters)
High Flow Series Twin DF2XX Manifold	2	4.2 gpm (15.9 lpm)	Flush 10.0 gals through cartridge(s) before use (flush approx. 2 mins.)	50,000 gallons (189,271 liters)
High Flow Series Single DP1XX Manifold	1	2.1 gpm (7.9 lpm)	Flush 5.0 gals through cartridge(s) before use (flush approx. 2 mins.)	25,000 gallons (94,635 liters)
High Flow Series Twin DP2XX Manifold	2	4.2 gpm (15.9 lpm)	Flush 10.0 gals through cartridge(s) before use (flush approx. 2 mins.)	50,000 gallons (189,271 liters)
High Flow Series Triple DP3XX Manifold	3	6.3 gpm (23.8 lpm)	Flush 15.0 gals through cartridge(s) before use (flush approx. 2 mins.)	75,000 gallons (283,906 liters)
High Flow Series Single SF1XX Manifold	1	2.1 gpm (7.9 lpm)	Flush 5.0 gals through cartridge(s) before use (flush approx. 2 mins.)	25,000 gallons (94,635 liters)
High Flow Series DIDF2XX Manifold	2	4.2 gpm (15.9 lpm)	Flush 10.0 gals through cartridge(s) before use (flush approx. 2 mins.)	50,000 gallons (189,271 liters)

Performance Data Sheet

Model: High Flow Series/ HF60 and HF60-S

Use Replacement Cartridge: HF60 or HF60-S



System tested and certified by NSF International against NSF/ANSI Standard 42, Standard 53 and CSA B483.1 for the reduction of substances as listed below.

The concentration of the indicated substances in water entering the system was reduced to a concentration less than or equal to the permissible limit for water leaving the system as specified in NSF/ANSI Standard 42, Standard 53 and CSA B483.1.

Capacity: See chart on next page.
Contaminant Reduction Determined by NSF testing.

Contaminant Reduction	Average Influent	NSF/ANSI specified Challenge Concentration	Avg % Reduction	Average Product Water Concentration	Max Permissible Product Water Concentration	NSF/ANSI Reduction Requirements	NSF Test Report
Chlorine Taste and Odor	2.0 mg/L	2.0 mg/L ± 10%	97.5%	0.05 mg/L	N/A	≥ 50%	J-00120457
Nominal Particulate Class I, 0.5 ≤ 1.0 µm	4,066,667 pti/mL	At least 10,000 particles/mL	99.9%	2565 pti/mL	N/A	≥ 85%	J-00125785
Cyst* * Based on the use of <i>Cryptosporidium parvum</i> oocysts	120,000 cysts/L	Minimum 50,000 cysts/L	99.98%	13 cysts/L	N/A	≥ 99.95%	J-00125784

FOR COMMERCIAL USE ONLY

Application Guidelines	Water Supply Parameters
Service Flow	See chart on next page
Water Supply	Potable Water
Water Pressure	25-125 psi (172 - 862 kPa)
Water Temperature	40° F - 100° F (4.4° C - 38° C)

It is essential that the manufacturer's recommended installation, maintenance and filter replacement requirements be carried out for the product to perform as advertised. See System Installation Manual for Warranty information.

Note: While the testing was performed under standard laboratory conditions, actual performance may vary.

Replacement Cartridge: HF60 or HF60-S. For estimated costs of replacement elements please call 866.990.9785 or visit our website at www.3Mpurification.com

Parts and service available from:



3M Purification Inc.
400 Research Parkway
Meriden, CT 06450, U.S.A.
Tel (866) 990-9785
Fax (203) 237-5541
www.3Mpurification.com

3M is a trademark of 3M Company used under license.
© 2020 3M Company. All rights reserved.
NSF is a trademark of NSF International

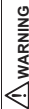

WARNING

Read entire manual. Failure to follow all guides and rules could cause personal injury or property damage.

- Check with your local public works department for plumbing codes. You must follow their guidelines as you install the water filtration system.
- Your water filtration system will withstand up to 125 pounds per square inch (psi) water pressure. If your house water supply pressure is higher than 80 psi, install a pressure reducing valve before installing the water filtration system.

To reduce the risk associated with the ingestion of contaminants:

- DO NOT use with water that is microbiologically unsafe or of unknown quality without adequate disinfection before or after the system. Systems certified for cyst reduction may be used on disinfected water that may contain filterable cysts.

NOTICE

To reduce the risk associated with water leakage or flooding:

- Read and follow Use Instructions before installation and use of this system.
- Change the disposable filter cartridge at the recommended interval; the disposable filter cartridge MUST be replaced every 12 months or sooner.
- Failure to replace the disposable filter cartridge at recommended intervals may lead to reduced filter performance and failure of the filter, causing property damage from water leakage or flooding.

Performance Data Sheet
Model: High Flow Series/HF60 and HF60-S
 Use Replacement Cartridge HF60 or HF60-S

HF60 and HF60-S Cartridge Flow and Capacity Information

Head & Manifold	# of Cartridges	Flow Rate	Flush Instructions	Capacity
NH3 Series Head	1	3.34 gpm (12.6 lpm)	Flush 7.0 gals through cartridge(s) before use (flush approx. 2 mins.)	35,000 gallons (132,475 liters)
VH3 Series Head	1	3.34 gpm (12.6 lpm)	Flush 7.0 gals through cartridge(s) before use (flush approx. 2 mins.)	35,000 gallons (132,475 liters)
High Flow Series Twin 2XX Manifold	2	6.68 gpm (25.3 lpm)	Flush 13.5 gals through cartridge(s) before use (flush approx. 2 mins.)	70,000 gallons (264,950 liters)
High Flow Series Triple 3XX Manifold	3	10.02 gpm (37.9 lpm)	Flush 20.1 gals through cartridge(s) before use (flush approx. 2 mins.)	105,000 gallons (397,425 liters)
High Flow Series Single DF1XX Manifold	1	3.34 gpm (12.6 lpm)	Flush 7.0 gals through cartridge(s) before use (flush approx. 2 mins.)	35,000 gallons (132,475 liters)
High Flow Series Twin DF2XX Manifold	2	6.68 gpm (25.3 lpm)	Flush 13.5 gals through cartridge(s) before use (flush approx. 2 mins.)	70,000 gallons (264,950 liters)
High Flow Series Single DP1XX Manifold	1	3.34 gpm (12.6 lpm)	Flush 7.0 gals through cartridge(s) before use (flush approx. 2 mins.)	35,000 gallons (132,475 liters)
High Flow Series Twin DP2XX Manifold	2	6.68 gpm (25.3 lpm)	Flush 13.5 gals through cartridge(s) before use (flush approx. 2 mins.)	70,000 gallons (264,950 liters)
High Flow Series Triple DP3XX Manifold	3	10.02 gpm (37.9 lpm)	Flush 20.1 gals through cartridge(s) before use (flush approx. 2 mins.)	105,000 gallons (397,425 liters)
High Flow Series Single SF1XX Manifold	1	3.34 gpm (12.6 lpm)	Flush 7.0 gals through cartridge(s) before use (flush approx. 2 mins.)	35,000 gallons (132,475 liters)
High Flow Series DIF2XX Manifold	2	6.68 gpm (25.3 lpm)	Flush 13.5 gals through cartridge(s) before use (flush approx. 2 mins.)	70,000 gallons (264,950 liters)

Performance Data Sheet

Model: High Flow Series HF65 and HF65-S

Use Replacement Cartridge HF65 or HF65-S



System tested and certified by NSF International against NSF/ANSI Standard 42 and CSA B483.1 for the reduction of substances as listed below.

The concentration of the indicated substances in water entering the system was reduced to a concentration less than or equal to the permissible limit for water leaving the system as specified in NSF/ANSI Standard 42 and CSA B483.1.

Capacity: See chart on next page.
Contaminant Reduction Determined by NSF testing.

Contaminant Reduction	Average Influent	NSF/ANSI specified Challenge Concentration	Avg % Reduction	Average Product Water Concentration	Max Permissible Product Water Concentration	NSF Reduction Requirements	NSF Test Report
Chlorine Taste and Odor	1.9 mg/L	2.0 mg/L \pm 10%	91.1%	0.17 mg/L	N/A	\geq 50%	J-00177374

FOR COMMERCIAL USE ONLY

Application Guidelines/Water Supply Parameters	
Service Flow	See chart on next page
Water Supply	Potable Water
Water Pressure	25-125 psi (172 - 862 kPa)
Water Temperature	40° F - 100° F (4.4° C - 38° C)

It is essential that the manufacturer's recommended installation, maintenance and filter replacement requirements be carried out for the product to perform as advertised. See System Installation Manual for Warranty information.

Note: While the testing was performed under standard laboratory conditions, actual performance may vary.

Replacement Cartridge: HF65 or HF65-S. For estimated costs of replacement elements please call 866.990.9785 or visit our website at www.3Mpurification.com

Parts and service available from:



3M Purification Inc.
400 Research Parkway
Meriden, CT 06450, U.S.A.
Tel (866) 990-9785
(203) 237-5541
Fax (203) 238-8701
www.3Mpurification.com

3M is a trademark of 3M Company used under license.
© 2020 3M Company. All rights reserved.
NSF is a trademark of NSF International

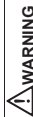

WARNING
Read entire manual. Failure to follow all guides and rules could cause personal injury or property damage.

- Check with your local public works department for plumbing codes. You must follow their guidelines as you install the water filtration system.
- Your water filtration system will withstand up to 125 pounds per square inch (psi) water pressure. If your house water supply pressure is higher than 80 psi, install a pressure reducing valve before installing the water filtration system.
- To reduce the risk associated with the ingestion of contaminants:**
 - DO NOT use with water that is microbiologically unsafe or of unknown quality without adequate disinfection before or after the system.

NOTICE

To reduce the risk associated with water leakage or flooding:

- Read and follow Use Instructions before installation and use of this system.
- Change the disposable filter cartridge at the recommended interval; the disposable filter cartridge **MUST** be replaced every 12 months or sooner.
- Failure to replace the disposable filter cartridge at recommended intervals may lead to reduced filter performance and failure of the filter, causing property damage from water leakage or flooding.

Performance Data Sheet
Model: High Flow Series HF65 and HF65-S
 Use Replacement Cartridge HF65 or HF 65-S

HF65 and H65-S Cartridge Flow and Capacity Information

Head & Manifold	# of Cartridges	Flow Rate	Flush Instruction	Capacity
NH3 Series Head	1	3.34 gpm (12.64 lpm)	Flush 7.0 gals through cartridge(s) before use (flush approx. 2 mins.)	35,000 gallons (132,489 liters)
VH3 Series Head	1	3.34 gpm (12.64 lpm)	Flush 7.0 gals through cartridge(s) before use (flush approx. 2 mins.)	35,000 gallons (132,489 liters)
High Flow Series Twin 2XX Manifold	2	6.68 gpm (25.28 lpm)	Flush 13.5 gals through cartridge(s) before use (flush approx. 2 mins.)	70,000 gallons (264,979 liters)
High Flow Series Triple 3XX Manifold	3	10.02 gpm (37.92 lpm)	Flush 20.1 gals through cartridge(s) before use (flush approx. 2 mins.)	105,000 gallons (397,468 liters)
High Flow Series Single DF1XX Manifold	1	3.34 gpm (12.64 lpm)	Flush 7.0 gals through cartridge(s) before use (flush approx. 2 mins.)	35,000 gallons (132,489 liters)
High Flow Series Twin DF2XX Manifold	2	6.68 gpm (25.28 lpm)	Flush 13.5 gals through cartridge(s) before use (flush approx. 2 mins.)	70,000 gallons (264,979 liters)
High Flow Series Single DP1XX Manifold	1	3.34 gpm (12.64 lpm)	Flush 7.0 gals through cartridge(s) before use (flush approx. 2 mins.)	35,000 gallons (132,489 liters)
High Flow Series Twin DP2XX Manifold	2	6.68 gpm (25.28 lpm)	Flush 13.5 gals through cartridge(s) before use (flush approx. 2 mins.)	70,000 gallons (264,979 liters)
High Flow Series Triple DP3XX Manifold	3	10.02 gpm (37.92 lpm)	Flush 20.1 gals through cartridge(s) before use (flush approx. 2 mins.)	105,000 gallons (397,468 liters)
High Flow Series Single SF1XX Manifold	1	3.34 gpm (12.64 lpm)	Flush 7.0 gals through cartridge(s) before use (flush approx. 2 mins.)	35,000 gallons (132,489 liters)
High Flow Series DIF2XX Manifold	2	6.68 gpm (25.28 lpm)	Flush 13.5 gals through cartridge(s) before use (flush approx. 2 mins.)	70,000 gallons (264,979 liters)

Performance Data Sheet

Model: High Flow Series/ HF60-CL and HF60-CLS

Use Replacement Cartridge: HF60-CL and HF60-CLS



US
C

System tested and certified by NSF International against NSF/ANSI Standard 42, Standard 53 and CSA B483.1 for the reduction of claims specified on the Performance Data Sheet.

The concentration of the indicated substances in water entering the system was reduced to a concentration less than or equal to the permissible limit for water leaving the system as specified in NSF/ANSI Standard 42, Standard 53 and CSA B483.1.

Contaminant Reduction Determined by NSF testing.

Substance Reduction	Average Influent Concentration	NSF specified Challenge Concentration	Avg % Reduction	Average Product Water Concentration	Max Permissible Product Water Concentration	NSF Reduction Requirements	NSF Test Report
Nominal Particulate Class I, ≥ 0.5 to < 1.0 μm	4,066,667 pps/mL	At least 10,000 particles/mL	99.9%	2,565 pps/mL	N/A	$\geq 85\%$	J-00125785
Cyst* Based on the use of <i>Cryptosporidium parvum</i> oocysts	120,000 cysts/L	Minimum 50,000 cysts/L	99.98%	13 cysts/L	N/A	$\geq 99.95\%$	J-00125784

FOR COMMERCIAL USE ONLY

Application Guidelines/Water Supply Parameters

Service Flow	See chart on next page
Water Supply	Potable Water
Water Pressure	25 - 125 psi (172 - 862 kPa)
Water Temperature	40° F - 100° F (4.4° C - 38° C)

It is essential that the manufacturer's recommended installation, maintenance and filter replacement requirements be carried out for the product to perform as advertised. See System Installation Manual for Warranty information.

Note: While the testing was performed under standard laboratory conditions, actual performance may vary.

Replacement Cartridge: HF60-CL and HF60-CLS. For estimated costs of replacement elements please call 866.990.9785 or visit our website at www.3Mpurification.com

Parts and service available from:



3M Purification Inc.
400 Research Parkway
Meriden, CT 06450, U.S.A.
Tel (866) 990-9785
(203) 237-5541
Fax (203) 238-8701
www.3Mpurification.com

3M is a trademark of 3M Company used under license.
© 2020 3M Company. All rights reserved.
NSF is a trademark of NSF International

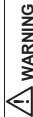

WARNING

Read entire manual. Failure to follow all guides and rules could cause personal injury or property damage.

- Check with your local public works department for plumbing codes. You must follow their guidelines as you install the water filtration system.
- Your water filtration system will withstand up to 125 pounds per square inch (psi) water pressure. If your house water supply pressure is higher than 80 psi, install a pressure reducing valve before installing the water filtration system.

To reduce the risk associated with the ingestion of contaminants:

- DO NOT use with water that is microbiologically unsafe or of unknown quality without adequate disinfection before or after the system. Systems certified for cyst reduction may be used on disinfected water that may contain filterable cysts.

NOTICE

To reduce the risk associated with water leakage or flooding:

- Read and follow Use Instructions before installation and use of this system.
- Change the disposable filter cartridge at the recommended interval; the disposable filter cartridge **MUST** be replaced every 12 months or sooner.
- Failure to replace the disposable filter cartridge at recommended intervals may lead to reduced filter performance and failure of the filter, causing property damage from water leakage or flooding.

Performance Data Sheet
Model: High Flow Series/ HF60-CL and HF60-CLS
 Use Replacement Cartridge HF60-CL or HF60-CLS

HF60-CL and HF60-CLS Cartridge Flow and Capacity Information

Head & Manifold	# of Cartridges	Flow Rate	Flush Instruction	Capacity
NH3 Series Head	1	2.2 gpm (8.3 lpm)	Flush 7.0 gals through cartridge(s) before use	4,700 gallons (17,790 liters)
VH3 Series Head	1	2.2 gpm (8.3 lpm)	Flush 7.0 gals through cartridge(s) before use	4,700 gallons (17,790 liters)
High Flow Series Twin 2XX Manifold	2	4.4 gpm (16.6 liters)	Flush 13.5 gals through cartridge(s) before use	9,400 gallons (35,580 liters)
High Flow Series Triple 3XX Manifold	3	6.6 gpm (24.9 liters)	Flush 20.1 gals through cartridge(s) before use	14,100 gallons (53,370 liters)
High Flow Series Single DF1XX Manifold	1	2.2 gpm (8.3 lpm)	Flush 7.0 gals through cartridge(s) before use	4,700 gallons (17,790 liters)
High Flow Series Twin DF2XX Manifold	2	4.4 gpm (16.6 liters)	Flush 13.5 gals through cartridge(s) before use	9,400 gallons (35,580 liters)
High Flow Series Single DP1XX Manifold	1	2.2 gpm (8.3 lpm)	Flush 7.0 gals through cartridge(s) before use	4,700 gallons (17,790 liters)
High Flow Series Twin DP2XX Manifold	2	4.4 gpm (16.6 liters)	Flush 13.5 gals through cartridge(s) before use	9,400 gallons (35,580 liters)
High Flow Series Triple DP3XX Manifold	3	6.6 gpm (24.9 liters)	Flush 20.1 gals through cartridge(s) before use	14,100 gallons (53,370 liters)
High Flow Series Single SF1XX Manifold	1	2.2 gpm (8.3 lpm)	Flush 7.0 gals through cartridge(s) before use	4,700 gallons (17,790 liters)
High Flow Series DDF2XX Manifold	2	4.4 gpm (16.6 liters)	Flush 13.5 gals through cartridge(s) before use	9,400 gallons (35,580 liters)

Performance Data Sheet

Model: High Flow Series/ HF65-CL

Use Replacement Cartridge: HF65-CL

System tested and certified by NSF International against NSF/ANSI Standard 42 and CSA B483.1 for the reduction of substances as listed below.



The concentration of the indicated substances in water entering the system was reduced to a concentration less than or equal to the permissible limit for water leaving the system as specified in NSF/ANSI Standard 42 and CSA B483.1.

Capacity: See chart on next page.
Contaminant Reduction Determined by NSF Testing

Contaminant Reduction	Average Influent	NSF/ANSI specified Challenge Concentration	Avg % Reduction	Average Product Water Concentration	Max Permissible Product Water Concentration	NSF Reduction Requirements	NSF Test Report
Nominal Particulate Class V, $\geq 30.0 \mu\text{m}$ to $\leq 1.0 \mu\text{m}$	6,133 pps/mL	At least 1,000 particles/mL	97.4%	159 pps/mL	N/A	$\geq 85\%$	J-00099135
Chlorine Taste and Odor	2.1 mg/L	2.0 mg/L $\pm 10\%$	97.6%	0.05 mg/L	N/A	$\geq 50\%$	J-00097231
Chloramine @ 2.1 ppm	3.1 mg/L	3.0 mg/L $\pm 10\%$	95.2%	0.13 mg/L	0.5 mg/L	N/A	J-00112392
Chloramine @ 1.7 ppm	3.0 mg/L	3.0 mg/L $\pm 10\%$	94.5%	0.17 mg/L	0.5 mg/L	N/A	J-00112394
Chloramine @ 1.0 ppm	3.0 mg/L	3.0 mg/L $\pm 10\%$	92.8%	0.17 mg/L	0.5 mg/L	N/A	J-00112395

FOR COMMERCIAL USE ONLY

Application Guidelines/Water Supply Parameters:

Service Flow	See chart on next page
Water Supply	Potable Water
Water Pressure	25 -125 psi (172 – 862 kPa)
Water Temperature	40° F - 100° F (4.4° C - 38° C)
Capacity:	
Capacity @ 2.1 gpm	7,000 gallons (26,498 liters)
Capacity @ 1.7 gpm	8,000 gallons (30,283 liters)
Capacity @ 1.0 gpm	15,000 gallons (56,781 liters)

It is essential that the manufacturer's recommended installation, maintenance and filter replacement requirements be carried out for the product to perform as advertised. See System Installation Manual for Warranty Information.

Note: While the testing was performed under standard laboratory conditions, actual performance may vary.

Replacement Cartridge: HF65-CL. For estimated costs of replacement elements please call 866.990.9785 or visit our website at www.3Mpurification.com

Parts and service available from:



3M Purification Inc.
400 Research Parkway
Meriden, CT 06450, U.S.A.
Tel (866) 990-9785
(203) 237-5541
Fax (203) 238-8701
www.3Mpurification.com

3M is a trademark of 3M Company used under license.
© 2020 3M Company. All rights reserved.
NSF is a trademark of NSF International



WARNING

Read entire manual. Failure to follow all guides and rules could cause personal injury or property damage.

- Check with your local public works department for plumbing codes. You must follow their guidelines as you install the water filtration system.
 - Your water filtration system will withstand up to 125 pounds per square inch (psi) water pressure. If your house water supply pressure is higher than 80 psi, install a pressure reducing valve before installing the water filtration system.
- To reduce the risk associated with the ingestion of contaminants:
- DO NOT use with water that is microbiologically unsafe or of unknown quality without adequate disinfection before or after the system.

NOTICE

- To reduce the risk associated with water leakage or flooding:
- Read and follow Use Instructions before installation and use of this system.
 - Change the disposable filter cartridge at the recommended interval; the disposable filter cartridge MUST be replaced every 12 months or sooner.
 - Failure to replace the disposable filter cartridge at recommended intervals may lead to reduced filter performance and failure of the filter, causing property damage from water leakage or flooding.

Performance Data Sheet

Model: High Flow Series/ HF65-CL

Use Replacement Cartridge HF65-CL

HF65-CL Cartridge Flow and Capacity Information

Head & Manifold	# of Cartridges	Flow Rate		Flush Instructions		Capacity
		2.1 gpm (7.9 lpm)	1.7 gpm (6.4 lpm)	Flush 7.0 gallons through cartridge(s) before use	7,000 gallons (26,498 liters)	
NH3 Series Head	1	1.7 gpm (6.4 lpm)	1.0 gpm (3.8 lpm)	Flush 7.0 gallons through cartridge(s) before use	7,000 gallons (26,498 liters)	
		2.1 gpm (7.9 lpm)	1.7 gpm (6.4 lpm)		8,000 gallons (30,283 liters)	
		1.7 gpm (6.4 lpm)	1.0 gpm (3.8 lpm)		15,000 gallons (56,781 liters)	
VH3 Series Head	1	1.7 gpm (6.4 lpm)	1.0 gpm (3.8 lpm)	Flush 7.0 gallons through cartridge(s) before use	7,000 gallons (26,498 liters)	
		2.1 gpm (7.9 lpm)	1.7 gpm (6.4 lpm)		8,000 gallons (30,283 liters)	
		1.7 gpm (6.4 lpm)	1.0 gpm (3.8 lpm)		15,000 gallons (56,781 liters)	
High Flow Series Twin 2XX Manifold	2	4.2 gpm (15.9 lpm)	3.4 gpm (12.9 lpm)	Flush 13.5 gallons through cartridge(s) before use	14,000 gallons (52,996 liters)	
		2.0 gpm (7.6 lpm)	1.7 gpm (6.4 lpm)		16,000 gallons (60,567 liters)	
		2.1 gpm (7.9 lpm)	1.7 gpm (6.4 lpm)		30,000 gallons (113,562 liters)	
High Flow Series Triple 3XX Manifold	3	6.3 gpm (23.8 lpm)	5.1 gpm (19.3 lpm)	Flush 20.1 gallons through cartridge(s) before use	21,000 gallons (79,494 liters)	
		2.0 gpm (7.6 lpm)	1.7 gpm (6.4 lpm)		24,000 gallons (90,850 liters)	
		2.1 gpm (7.9 lpm)	1.7 gpm (6.4 lpm)		45,000 gallons (170,344 liters)	
High Flow Series Single DF1XX Manifold	1	2.1 gpm (7.9 lpm)	1.7 gpm (6.4 lpm)	Flush 7.0 gallons through cartridge(s) before use	7,000 gallons (26,498 liters)	
		1.0 gpm (3.8 lpm)	1.0 gpm (3.8 lpm)		8,000 gallons (30,283 liters)	
		1.0 gpm (3.8 lpm)	1.0 gpm (3.8 lpm)		15,000 gallons (56,781 liters)	
High Flow Series Twin DF2XX Manifold	2	4.2 gpm (15.9 lpm)	3.4 gpm (12.9 lpm)	Flush 13.5 gallons through cartridge(s) before use	14,000 gallons (52,996 liters)	
		2.0 gpm (7.6 lpm)	1.7 gpm (6.4 lpm)		16,000 gallons (60,567 liters)	
		2.1 gpm (7.9 lpm)	1.7 gpm (6.4 lpm)		30,000 gallons (113,562 liters)	
High Flow Series Single DP1XX Manifold	1	1.7 gpm (6.4 lpm)	1.0 gpm (3.8 lpm)	Flush 7.0 gallons through cartridge(s) before use	7,000 gallons (26,498 liters)	
		1.0 gpm (3.8 lpm)	1.0 gpm (3.8 lpm)		8,000 gallons (30,283 liters)	
		1.0 gpm (3.8 lpm)	1.0 gpm (3.8 lpm)		15,000 gallons (56,781 liters)	
High Flow Series Twin DP2XX Manifold	2	4.2 gpm (15.9 lpm)	3.4 gpm (12.9 lpm)	Flush 13.5 gallons through cartridge(s) before use	14,000 gallons (52,996 liters)	
		2.0 gpm (7.6 lpm)	1.7 gpm (6.4 lpm)		16,000 gallons (60,567 liters)	
		2.1 gpm (7.9 lpm)	1.7 gpm (6.4 lpm)		30,000 gallons (113,562 liters)	
High Flow Series Triple DP3XX Manifold	3	6.3 gpm (23.8 lpm)	5.1 gpm (19.3 lpm)	Flush 20.1 gallons through cartridge(s) before use	21,000 gallons (79,494 liters)	
		2.0 gpm (7.6 lpm)	1.7 gpm (6.4 lpm)		24,000 gallons (90,850 liters)	
		2.1 gpm (7.9 lpm)	1.7 gpm (6.4 lpm)		45,000 gallons (170,344 liters)	
High Flow Series Single SF1XX Manifold	1	2.1 gpm (7.9 lpm)	1.7 gpm (6.4 lpm)	Flush 7.0 gallons through cartridge(s) before use	7,000 gallons (26,498 liters)	
		1.0 gpm (3.8 lpm)	1.0 gpm (3.8 lpm)		8,000 gallons (30,283 liters)	
		1.0 gpm (3.8 lpm)	1.0 gpm (3.8 lpm)		15,000 gallons (56,781 liters)	
High Flow Series DIF2XX Manifold	2	4.2 gpm (15.9 lpm)	3.4 gpm (12.9 lpm)	Flush 13.5 gallons through cartridge(s) before use	14,000 gallons (52,996 liters)	
		2.0 gpm (7.6 lpm)	1.7 gpm (6.4 lpm)		16,000 gallons (60,567 liters)	
		2.1 gpm (7.9 lpm)	1.7 gpm (6.4 lpm)		30,000 gallons (113,562 liters)	

Performance Data Sheet

Model: High Flow Series/HF90-CL and HF90-CLS

Use Replacement Cartridge HF90-CL and HF90-CLS
 The concentration of the indicated substances in water entering the system was reduced to a concentration less than or equal to the permissible limit for water leaving the system as specified in NSF/ANSI Standard 42, Standard 53 and CSA B483.1.



System tested and certified by NSF International against NSF/ANSI Standard 42, Standard 53 and CSA B483.1 for the reduction of substances as listed below.

Capacity: See chart on next page.

Contaminant Reduction Determined by NSF testing.

Substance Reduction	Average Influent	NSF/ANSI specified Challenge Concentration	Avg. % Reduction	Average Product Water Concentration	Max Permissible Product Water Concentration	NSF/ANSI Reduction Requirements	NSF Test Report
Chlorine Taste and Odor	2.9 mg/L	2.0 mg/L ± 10%	95.5%	0.13 mg/L	N/A	≥ 50%	J-00145563
Nominal Particulate Class I, 0.5 ≤ 1.0 µm	4,066,667 pts/mL	At least 10,000 particles/mL	99.9%	2565 pts/mL	N/A	≥ 85%	J-00125785
Chloramine	2.9 mg/L	2.0 mg/L ± 10%	95.5%	0.13 mg/L	N/A	≥ 50%	J-00145563
Cyst*	120,000 cysts/L	Minimum 50,000 cysts/L	99.98%	13 cyst/L	N/A	≥ 99.95%	J-00125784
Turbidity	11.5 NTU	11 ± 1 NTU	98.4%	0.19 NTU	0.5 NTU	N/A	J-00110254

* Based on the use of *Cryptosporidium parvum* oocysts

FOR COMMERCIAL USE ONLY

Application Guidelines/Water Supply Parameters

Service Flow	See chart on next page
Water Supply	Potable Water
Water Pressure	25 -125 psi (172 - 862 kPa)
Water Temperature	40° F - 100° F (4.4° C - 38° C)

It is essential that the manufacturer's recommended installation, maintenance and filter replacement requirements be carried out for the product to perform as advertised. See System Installation Manual for Warranty Information.

Note: While the testing was performed under standard laboratory conditions, actual performance may vary.

Replacement Cartridge: HF90-CL and HF90-CLS. For estimated costs of replacement elements please call 866.990.9785 or visit our website at www.3Mpurification.com

Parts and service available from:



3M Purification Inc.
 400 Research Parkway
 Meriden, CT 06450, U.S.A.
 Tel (866) 990-9785
 (203) 237-5541
 Fax (203) 238-8701
www.3Mpurification.com

3M is a trademark of 3M Company used under license.
 © 2020 3M Company. All rights reserved.
 NSF is a trademark of NSF International

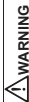

WARNING

Read entire manual. Failure to follow all guides and rules could cause personal injury or property damage.

- Check with your local public works department for plumbing codes. You must follow their guidelines as you install the water filtration system.
- Your water filtration system will withstand up to 125 pounds per square inch (psi) water pressure. If your house water supply pressure is higher than 80 psi, install a pressure reducing valve before installing the water filtration system.

To reduce the risk associated with the ingestion of contaminants:

- DO NOT use with water that is microbiologically unsafe or of unknown quality without adequate disinfection before or after the system. Systems certified for cyst reduction may be used on disinfected water that may contain filterable cysts.

NOTICE

To reduce the risk associated with water leakage or flooding:

- Read and follow Use Instructions before installation and use of this system.
- Change the disposable filter cartridge at the recommended interval; the disposable filter cartridge MUST be replaced every 12 months or sooner.
- Failure to replace the disposable filter cartridge at recommended intervals may lead to reduced filter performance and failure of the filter, causing property damage from water leakage or flooding.

Performance Data Sheet
Model: High Flow Series/HF90-CL and HF90-CLS
 Use Replacement Cartridge HF90-CL or HF90-CLS

HF90-CL and HF90-CLS Cartridge Flow and Capacity Information

Head & Manifold	# of Cartridges	Flow Rate	Flush Instruction	Capacity
NH3 Series Head	1	1.33 gpm (5.0 lpm)	Flush 10.0 gals through cartridge(s) before use	12,500 gallons (47,317 liters)
VH3 Series Head	1	1.33 gpm (5.0 lpm)	Flush 10.0 gals through cartridge(s) before use	12,500 gallons (47,317 liters)
High Flow Series Twin 2XX Manifold	2	2.66 gpm (10.1 lpm)	Flush 20.0 gals through cartridge(s) before use	25,000 gallons (94,635 liters)
High Flow Series Triple 3XX Manifold	3	3.99 gpm (15.1 lpm)	Flush 30.0 gals through cartridge(s) before use	37,500 gallons (141,952 liters)
High Flow Series Single DF1XX Manifold	1	1.33 gpm (5.0 lpm)	Flush 10.0 gals through cartridge(s) before use	12,500 gallons (47,317 liters)
High Flow Series Twin DF2XX Manifold	2	2.66 gpm (10.1 lpm)	Flush 20.0 gals through cartridge(s) before use	25,000 gallons (94,635 liters)
High Flow Series Single DP1XX Manifold	1	1.33 gpm (5.0 lpm)	Flush 10.0 gals through cartridge(s) before use	12,500 gallons (47,317 liters)
High Flow Series Twin DP2XX Manifold	2	2.66 gpm (10.1 lpm)	Flush 20.0 gals through cartridge(s) before use	25,000 gallons (94,635 liters)
High Flow Series Triple DP3XX Manifold	3	3.99 gpm (15.1 lpm)	Flush 30.0 gals through cartridge(s) before use	37,500 gallons (141,952 liters)
High Flow Series Single SF1XX Manifold	1	1.33 gpm (5.0 lpm)	Flush 10.0 gals through cartridge(s) before use	12,500 gallons (47,317 liters)
High Flow Series DIF2XX Manifold	2	2.66 gpm (10.1 lpm)	Flush 20.0 gals through cartridge(s) before use	25,000 gallons (94,635 liters)

Performance Data Sheet

Model: High Flow Series/HF95-CL

Use Replacement Cartridge HF95-CL



System tested and certified by NSF International against NSF/ANSI Standard 42 and CSA B483.1 for the reduction of substances as specified below.

The concentration of the indicated substances in water entering the system was reduced to a concentration less than or equal to the permissible limit for water leaving the system as specified in NSF/ANSI Standard 42 and CSA B483.1.

Capacity: See chart on next page.
Contaminant Reduction Determined by NSF testing

Contaminant Reduction	Average Infiltrant	NSF specified Challenge Concentration	Avg % Reduction	Average Product Water Concentration	Max Permissible Product Water Concentration	NSF Reduction Requirements	NSF Test Report
Chlorine Taste and Odor	2.1 mg/L	2.0 mg/L ± 10%	97.6%	0.05 mg/L	N/A	≥ 50%	J-00097231
Nominal Particulate Class V ≥ 30.0 µm to ≤ 1.0 µm	6,133 pps/mL	At least 1,000 particles/mL	97.4%	159 pts/mL	N/A	≥85%	J-00099135

FOR COMMERCIAL USE ONLY

Application Guidelines/Water Supply Parameters	
Service Flow	See chart on next page
Water Supply	Potable Water
Water Pressure	25 - 125 psi (172 - 862 kPa)
Water Temperature	40° F - 100° F (4.4° C - 37.8° C)

It is essential that the manufacturer's recommended installation, maintenance and filter replacement requirements be carried out for the product to perform as advertised. See System Installation Manual for Warranty information.

Note: While the testing was performed under standard laboratory conditions, actual performance may vary.

Replacement Cartridge: HF95-CL. For estimated costs of replacement elements please call 1-800-222-7880 or visit our website at www.3Mpurification.com

Parts and service available from:



3M Purification Inc.
400 Research Parkway
Meriden, CT 06450, U.S.A.
Tel (866) 990-9785
Tel (203) 237-5541
Fax (203) 238-8701
www.3Mpurification.com

3M is a trademark of 3M Company used under license.
© 2020 3M Company. All rights reserved.
NSF is a trademark of NSF International



WARNING
Read entire manual. Failure to follow all guides and rules could cause personal injury or property damage.

- Check with your local public works department for plumbing codes. You must follow their guidelines as you install the water filtration system.
- Your water filtration system will withstand up to 125 pounds per square inch (psi) water pressure. If your house water supply pressure is higher than 80 psi, install a pressure reducing valve before installing the water filtration system.

To reduce the risk associated with the ingestion of contaminants:

- DO NOT use with water that is microbiologically unsafe or of unknown quality without adequate disinfection before or after the system.

NOTICE

To reduce the risk associated with water leakage or flooding:

- Read and follow Use Instructions before installation and use of this system.
- Change the disposable filter cartridge at the recommended interval; the disposable filter cartridge MUST be replaced every 12 months or sooner.
- Failure to replace the disposable filter cartridge at recommended intervals may lead to reduced filter performance and failure of the filter, causing property damage from water leakage or flooding.

Performance Data Sheet

Model: High Flow Series/HF95-CL

Use Replacement Cartridge HF95-CL

HF95-CL Cartridge Flow and Capacity Information

Head & Manifold	# of Cartridges	Flow Rate	Flush Instruction	Capacity
NH3 Series Head	1	2.5 gpm (9.5 lpm)	Flush 10.0 gals through cartridge(s) before use	30,000 gallons (113,550 liters)
VH3 Series Head	1	2.5 gpm (9.5 lpm)	Flush 10.0 gals through cartridge(s) before use	30,000 gallons (113,550 liters)
High Flow Series Twin 2XX Manifold	2	5.0 gpm (18.93 lpm)	Flush 20.0 gals through cartridge(s) before use	60,000 gallons (227,100 liters)
High Flow Series Triple 3XX Manifold	3	7.5 gpm (22.5 lpm)	Flush 30.0 gals through cartridge(s) before use	90,000 gallons (340,650 liters)
High Flow Series Single DF1XX Manifold	1	2.5 gpm (9.5 lpm)	Flush 10.0 gals through cartridge(s) before use	30,000 gallons (113,550 liters)
High Flow Series Twin DF2XX Manifold	2	5.0 gpm (18.93 lpm)	Flush 20.0 gals through cartridge(s) before use	60,000 gallons (227,100 liters)
High Flow Series Single DP1XX Manifold	1	2.5 gpm (9.5 lpm)	Flush 10.0 gals through cartridge(s) before use	30,000 gallons (113,550 liters)
High Flow Series Twin DP2XX Manifold	2	5.0 gpm (18.93 lpm)	Flush 20.0 gals through cartridge(s) before use	60,000 gallons (227,100 liters)
High Flow Series Triple DP3XX Manifold	3	7.5 gpm (22.5 lpm)	Flush 30.0 gals through cartridge(s) before use	90,000 gallons (340,650 liters)
High Flow Series Single SF1XX Manifold	1	2.5 gpm (9.5 lpm)	Flush 10.0 gals through cartridge(s) before use	30,000 gallons (113,550 liters)
High Flow Series DIF2XX Manifold	2	5.0 gpm (18.93 lpm)	Flush 20.0 gals through cartridge(s) before use	60,000 gallons (227,100 liters)

Performance Data Sheet

Model: High Flow Series/HF90 and HF90-S

Use Replacement Cartridge HF90 and HF90-S
 The concentration of the indicated substances in water entering the system was reduced to a concentration less than or equal to the permissible limit for water leaving the system as specified in NSF/ANSI Standard 42, Standard 53 and CSA B483.1.



System tested and certified by NSF International against NSF/ANSI Standard 42, Standard 53 and CSA B483.1 for the reduction of substances as listed below...

Capacity: See chart on next page.
 Contaminant Reduction Determined by NSF testing.

Substance Reduction	Average Influent	NSF/ANSI specified Challenge Concentration	Avg % Reduction	Average Product Water Concentration	Max Permissible Product Water Concentration	NSF/ANSI Reduction Requirements	NSF Test Report
Chlorine Taste and Odor	2.0 mg/L	2.0 mg/L ± 10%	96.3%	0.07 mg/L	N/A	≥ 90%	J-00128559
Nominal Particulate Class I, 0.5 ≤ 1.0 µm	4,066,667 pts/mL	At least 10,000 particles/mL	99.9%	2,565 pts/mL	N/A	≥ 85%	J-00125785
Cyst*	120,000 cysts/L	Minimum 50,000 cysts/L	99.98%	13 cysts/L	N/A	≥ 99.95%	J-00125784
Turbidity	11.5 NTU	11 ± 1 NTU	98.4%	0.19 NTU	0.5 NTU	N/A	J-00110254

* Based on the use of Cryptosporidium parvum oocysts

FOR COMMERCIAL USE ONLY

Application Guidelines/Water Supply Parameters	
Service Flow	See chart on next page
Water Supply	Potable Water
Water Pressure	25-125 psi (1.72 - 862 kPa)
Water Temperature	40° F - 100° F (4° C - 38° C)

It is essential that the manufacturer's recommended installation, maintenance and filter replacement requirements be carried out for the product to perform as advertised. See System Installation Manual for Warranty information.

Note: While the testing was performed under standard laboratory conditions, actual performance may vary.

Replacement Cartridge: HF90 and HF90-S. For estimated costs of replacement elements please call 866.990.9785 or visit our website at www.3Mpurification.com

Parts and service available from:



3M Purification Inc.
 400 Research Parkway
 Meriden, CT 06450, U.S.A.
 Tel (866) 990-9785
 (203) 237-5541
 Fax (203) 238-8701
www.3Mpurification.com

3M is a trademark of 3M Company used under license.
 © 2020 3M Company. All rights reserved.
 NSF is a trademark of NSF International



WARNING

- Read entire manual. Failure to follow all guides and rules could cause personal injury or property damage.**
- Check with your local public works department for plumbing codes. You must follow their guidelines as you install the water filtration system.
 - Your water filtration system will withstand up to 125 pounds per square inch (psi) water pressure. If your house water supply pressure is higher than 80 psi, install a pressure reducing valve before installing the water filtration system.

To reduce the risk associated with the ingestion of contaminants:

- DO NOT use with water that is microbiologically unsafe or of unknown quality without adequate disinfection before or after the system. Systems certified for cyst reduction may be used on disinfected water that may contain filterable cysts.

NOTICE

To reduce the risk associated with water leakage or flooding:

- Read and follow Use Instructions before installation and use of this system.
- Change the disposable filter cartridge at the recommended interval; the disposable filter cartridge MUST be replaced every 12 months or sooner.
- Failure to replace the disposable filter cartridge at recommended intervals may lead to reduced filter performance and failure of the filter, causing property damage from water leakage or flooding.

Performance Data Sheet
Model: High Flow Series/HF90 and HF90-S
 Use Replacement Cartridge HF90 or HF90-S

HF90 and HF90-S Flow and Capacity Information

Head & Manifold	# of Cartridges	Flow Rate	Flush Instructions	Capacity
NH3 Series Head	1	5 gpm (18.92 lpm)	Flush 10.0 gals through cartridge(s) before use (flush approx. 2 mins.)	54,000 gallons (204,412 liters)
VH3 Series Head	1	5 gpm (18.92 lpm)	Flush 10.0 gals through cartridge(s) before use (flush approx. 2 mins.)	54,000 gallons (204,412 liters)
High Flow Series Twin 2XX Manifold	2	10 gpm (37.85 lpm)	Flush 20.0 gals through cartridge(s) before use (flush approx. 2 mins.)	108,000 gallons (408,825 liters)
High Flow Series Triple 3XX Manifold	3	15 gpm (56.77 lpm)	Flush 30.0 gals through cartridge(s) before use (flush approx. 2 mins.)	162,000 gallons (613,236 liters)
High Flow Series Single DF1XX Manifold	1	5 gpm (18.92 lpm)	Flush 10.0 gals through cartridge(s) before use (flush approx. 2 mins.)	54,000 gallons (204,412 liters)
High Flow Series Twin DF2XX Manifold	2	10 gpm (37.85 lpm)	Flush 20.0 gals through cartridge(s) before use (flush approx. 2 mins.)	108,000 gallons (408,825 liters)
High Flow Series Single DP1XX Manifold	1	5 gpm (18.92 lpm)	Flush 10.0 gals through cartridge(s) before use (flush approx. 2 mins.)	54,000 gallons (204,412 liters)
High Flow Series Twin DP2XX Manifold	2	10 gpm (37.85 lpm)	Flush 20.0 gals through cartridge(s) before use (flush approx. 2 mins.)	108,000 gallons (408,825 liters)
High Flow Series Triple DP3XX Manifold	3	15 gpm (56.77 lpm)	Flush 30.0 gals through cartridge(s) before use (flush approx. 2 mins.)	162,000 gallons (613,236 liters)
High Flow Series Single SF1XX Manifold	1	5 gpm (18.92 lpm)	Flush 10.0 gals through cartridge(s) before use (flush approx. 2 mins.)	54,000 gallons (204,412 liters)
High Flow Series DIF2XX Manifold	2	10 gpm (37.85 lpm)	Flush 20.0 gals through cartridge(s) before use (flush approx. 2 mins.)	108,000 gallons (408,825 liters)

Performance Data Sheet

Model: High Flow Series/HF95 and HF95-S

Use Replacement Cartridge: HF95 or HF95-S

The concentration of the indicated substances in water entering the system was reduced to a concentration less than or equal to the permissible limit for water leaving the system as specified in NSF/ANSI Standard 42 and CSA B483.1.



System tested and certified by NSF International against NSF/ANSI Standard 42 and CSA B483.1 for the reduction of substances as listed below.

Capacity: See chart on next page.
Contaminant Reduction: Determined by NSF testing.

Substance Reduction	Average Influent	NSF/ANSI specified Challenge Concentration	Avg % Reduction	Average Product Water Concentration	Max Permissible Product Water Concentration	NSF Reduction Requirements	NSF Test Report
Chlorine Taste and Odor	2.0 mg/L	2.0 mg/L \pm 10%	96.6%	0.07 mg/L	N/A	\geq 50%	J-00089365

FOR COMMERCIAL USE ONLY

Application Guidelines/Water Supply Parameters

Service Flow	See chart on next page
Water Supply	Potable Water
Water Pressure	25-125 psi (172 - 862 kPa)
Water Temperature	40° F - 100° F (4.4° C - 38° C)

It is essential that the manufacturer's recommended installation, maintenance and filter replacement requirements be carried out for the product to perform as advertised. See System Installation Manual for Warranty information.

Note: While the testing was performed under standard laboratory conditions, actual performance may vary.

Replacement Cartridge: HF95 or HF95-S. For estimated costs of replacement elements please call 866.990.9785 or visit our website at www.3Mpurification.com

Parts and service available from:



3M Purification Inc.
400 Research Parkway
Menden, CT 06450, U.S.A.
Tel (866) 990-9785
(203) 237-5541
Fax (203) 236-8701
www.3Mpurification.com

3M is a trademark of 3M Company used under license.
© 2020 3M Company. All rights reserved.
NSF is a trademark of NSF International



WARNING

Read entire manual. Failure to follow all guides and rules could cause personal injury or property damage.

- Check with your local public works department for plumbing codes. You must follow their guidelines as you install the water filtration system.
- Your water filtration system will withstand up to 125 pounds per square inch (psi) water pressure. If your house water supply pressure is higher than 80 psi, install a pressure reducing valve before installing the water filtration system.

To reduce the risk associated with the ingestion of contaminants:

- DO NOT use with water that is microbiologically unsafe or of unknown quality without adequate disinfection before or after the system.

NOTICE

To reduce the risk associated with water leakage or flooding:

- Read and follow Use Instructions before installation and use of this system.
- Change the disposable filter cartridge at the recommended interval; the disposable filter cartridge **MUST** be replaced every 12 months or sooner.
- Failure to replace the disposable filter cartridge at recommended intervals may lead to reduced filter performance and failure of the filter, causing property damage from water leakage or flooding.

Performance Data Sheet

Model: High Flow Series/HF95 and HF95-S

Use Replacement Cartridge HF95 or HF95-S

HF95 and HF95-S Cartridge Flow and Capacity Information

Head & Manifold	# of Cartridges	Flow Rate	Flush Instructions	Capacity
NH3 Series Head	1	5 gpm (18.9 lpm)	Flush 10.0 gals through cartridge(s) before use (flush approx. 2 mins.)	54,000 gallons (204,390 liters)
VH3 Series Head	1	5 gpm (18.9 lpm)	Flush 10.0 gals through cartridge(s) before use (flush approx. 2 mins.)	54,000 gallons (204,390 liters)
High Flow Series Twin 2XX Manifold	2	10 gpm (37.9 lpm)	Flush 20.0 gals through cartridge(s) before use (flush approx. 2 mins.)	108,000 gallons (408,780 liters)
High Flow Series Triple 3XX Manifold	3	15 gpm (56.8 lpm)	Flush 30.0 gals through cartridge(s) before use (flush approx. 2 mins.)	162,000 gallons (613,170 liters)
High Flow Series Single DF1XX Manifold	1	5 gpm (18.9 lpm)	Flush 10.0 gals through cartridge(s) before use (flush approx. 2 mins.)	54,000 gallons (204,390 liters)
High Flow Series Twin DF2XX Manifold	2	10 gpm (37.9 lpm)	Flush 20.0 gals through cartridge(s) before use (flush approx. 2 mins.)	108,000 gallons (408,780 liters)
High Flow Series Single DP1XX Manifold	1	5 gpm (18.9 lpm)	Flush 10.0 gals through cartridge(s) before use (flush approx. 2 mins.)	54,000 gallons (204,390 liters)
High Flow Series Twin DP2XX Manifold	2	10 gpm (37.9 lpm)	Flush 20.0 gals through cartridge(s) before use (flush approx. 2 mins.)	108,000 gallons (408,780 liters)
High Flow Series Triple DP3XX Manifold	3	15 gpm (56.8 lpm)	Flush 30.0 gals through cartridge(s) before use (flush approx. 2 mins.)	162,000 gallons (613,170 liters)
High Flow Series Single SF1XX Manifold	1	5 gpm (18.9 lpm)	Flush 10.0 gals through cartridge(s) before use (flush approx. 2 mins.)	54,000 gallons (204,390 liters)
High Flow Series DIDF2XX Manifold	2	10 gpm (37.9 lpm)	Flush 20.0 gals through cartridge(s) before use (flush approx. 2 mins.)	108,000 gallons (408,780 liters)

Performance Data Sheet

Model: High Flow Series/HF20-A020-SR

Use Replacement Cartridge: HF20-A020-SR

The concentration of the indicated substances in water entering the system was reduced to a concentration less than or equal to the permissible limit for water leaving the system as specified in NSF/ANSI Standard 42, Standard 53 and CSA B483.1.



System tested and certified by NSF International against NSF/ANSI Standard 42, Standard 53 and CSA B483.1 for the reduction of substances as listed.

Substance Reduction	Average Influent	NSF specified Challenge Concentration	Contaminant Reduction	Average Product Water Concentration	Max Permissible Product Water Concentration	NSF Reduction Requirements	NSF Test Report
Particulate Class I, ≥0.5 to <1.0 µm	3,433,333 pts/mL	At least 10,000 pts/mL	99.3%	22,100 pts/mL	N/A	≥ 85%	J-00304397
Cyst Reduction*	135,000 cysts/L	Minimum 50,000 cysts/L	99.99%	1 cyst/L	N/A	99.95%	J-00304396

Capacity: See chart on next page. Contaminant Reduction Determined by NSF testing.

FOR COMMERCIAL USE ONLY

Application Guidelines/Water Supply Parameters	
Service Flow	2.0 gpm (7.6 lpm)
Water Supply	Potable Water
Water Pressure	25 - 125 psi (172 - 862 kPa)
Water Temperature	40° F - 100° F (4.4° C - 38° C)

It is essential that the manufacturer's recommended installation, maintenance and filter replacement requirements be carried out for the product to perform as advertised. See System Installation Manual for Warranty information.

Note: While the testing was performed under standard laboratory conditions, actual performance may vary.

Replacement Cartridge: HF20-A020-SR. For estimated costs of replacement elements please call 866.990.9785 or visit our website at www.3Mpurification.com

Parts and service available from:



3M Purification Inc.
 400 Research Parkway
 Meriden, CT 06450, U.S.A.
 Tel. (866) 990-9785
 (203) 237-5541
 Fax (203) 238-8701
www.3Mpurification.com

3M is a trademark of 3M Company used under license.
 © 2020 3M Company. All rights reserved.
 NSF is a trademark of NSF International

⚠WARNING

To reduce the risk associated with ingestion of contaminants:

- Do not use with water that is microbiologically unsafe or of unknown quality without adequate disinfection before and after the system. Systems certified for cyst reduction may be used on disinfected water that may contain filterable cysts.

Read entire manual. Failure to follow all guides and rules could cause personal injury or property damage.

- Check with your local public works department for plumbing codes. You must follow their guidelines as you install the water filtration system.
- Your water filtration system will withstand up to 125 pounds per square inch (psi) water pressure. If your water supply pressure is higher than 80 psi, install a pressure reducing valve before installing the water filtration system.

NOTICE

To reduce the risk associated with property damage due to water leakage or flooding:

- Read and follow all Instructions before installation and use of this system.
- Change the disposable filter cartridge at the recommended interval; the disposable filter cartridge MUST be replaced every 6 months or sooner.
- Failure to replace the disposable filter cartridge at recommended intervals may lead to reduced filter performance and failure of the filter, causing property damage from water leakage or flooding.

IMPORTANT: See flushing instructions on next page.

HF20-A020-SR Cartridge Flow and Capacity Information

Head & Manifold	# of Cartridges	Flow Rate	Flush Instruction	Capacity
NH3 Series Head	1	2 gpm (7.6 lpm)	Flush 4.0 gals through cartridge(s) before use (flush approx. 2 mins)	N/A
VH3 Series Head	1	2 gpm (7.6 lpm)	Flush 4.0 gals through cartridge(s) before use (flush approx. 2 mins)	N/A
High Flow Series Twin 2XX Manifold	2	4 gpm (15.1 lpm)	Flush 8.0 gals through cartridge(s) before use (flush approx. 2 mins)	N/A
High Flow Series Triple 3XX Manifold	3	6 gpm (22.7 lpm)	Flush 12.0 gals through cartridge(s) before use (flush approx. 2 mins)	N/A
High Flow Series Single DF1XX Manifold	1	2 gpm (7.6 lpm)	Flush 4.0 gals through cartridge(s) before use (flush approx. 2 mins)	N/A
High Flow Series Twin DF2XX Manifold	2	4 gpm (15.1 lpm)	Flush 8.0 gals through cartridge(s) before use (flush approx. 2 mins)	N/A
High Flow Series Single DP1XX Manifold	1	2 gpm (7.6 lpm)	Flush 4.0 gals through cartridge(s) before use (flush approx. 2 mins)	N/A
High Flow Series Twin DP2XX Manifold	2	4 gpm (15.1 lpm)	Flush 8.0 gals through cartridge(s) before use (flush approx. 2 mins)	N/A
High Flow Series Triple DP3XX Manifold	3	6 gpm (22.7 lpm)	Flush 12.0 gals through cartridge(s) before use (flush approx. 2 mins)	N/A
High Flow Series Single SF1XX Manifold	1	2 gpm (7.6 lpm)	Flush 4.0 gals through cartridge(s) before use (flush approx. 2 mins)	N/A
High Flow Series DIDF2XX Manifold	2	4 gpm (15.1 lpm)	Flush 8.0 gals through cartridge(s) before use (flush approx. 2 mins)	N/A

Performance Data Sheet

Model: High Flow Series/HF20-A020-S-SR

Use Replacement Cartridge: HF20-A020-S-SR

The concentration of the indicated substances in water entering the system was reduced to a concentration less than or equal to the permissible limit for water leaving the system as specified in NSF/ANSI Standard 42, Standard 53 and CSA B483.1.

 System tested and certified by NSF International against NSF/ANSI Standard 42, Standard 53 and CSA B483.1 for the reduction of substances as listed.

Capacity: See chart on next page.

Contaminant Reduction Determined by NSF testing.

Substance Reduction	Average Influent	NSF specified Challenge Concentration	Avg. % Reduction	Average Product Water Concentration	Max. Permissible Product Water Concentration	NSF Reduction Requirements	NSF Test Report
Particulate Class I, ≥ 0.5 to < 1.0 μm	3,433,333 pts/mL	At least 10,000 pts/mL	99.3%	22,100 pts/mL	N/A	$\geq 85\%$	J-00304397
Cyst Reduction*	135,000 cysts/L	Minimum 50,000 cysts/L	99.99%	1 cyst/L	N/A	99.95%	J-00304396

* Based on the use of *Cryptosporidium parvum* oocysts

FOR COMMERCIAL USE ONLY

Application Guidelines/Water Supply Parameters	
Service Flow	2.0 gpm (7.6 lpm)
Water Supply	Potable Water
Water Pressure	25 - 125 psi (172 - 862 kPa)
Water Temperature	40° F - 100° F (4.4° C - 38° C)

It is essential that the manufacturer's recommended installation, maintenance and filter replacement requirements be carried out for the product to perform as advertised. See System Installation Manual for Warranty information.

Note: While the testing was performed under standard laboratory conditions, actual performance may vary.

Replacement Cartridge: HF20-A020-S-SR. For estimated costs of replacement elements please call 866.990.9785 or visit our website at www.3Mpurification.com

Parts and service available from:



3M Purification Inc.
 400 Research Parkway
 Meriden, CT 06450, U.S.A.
 Tel (866) 990-9785
 Tel (203) 237-5541
 Fax (203) 238-8701
www.3Mpurification.com

3M is a trademark of 3M Company used under license.
 © 2020 3M Company. All rights reserved.
 NSF is a trademark of NSF International

⚠ WARNING

To reduce the risk associated with ingestion of contaminants:

- Do not use with water that is microbiologically unsafe or of unknown quality without adequate disinfection before and after the system. Systems certified for cyst reduction may be used on disinfected water that may contain filterable cysts.

Read entire manual. Failure to follow all guides and rules could cause personal injury or property damage.

- Check with your local public works department for plumbing codes. You must follow their guidelines as you install the water filtration system.
- Your water filtration system will withstand up to 125 pounds per square inch (psi) water pressure. If your water supply pressure is higher than 80 psi, install a pressure reducing valve before installing the water filtration system.

NOTICE

To reduce the risk associated with property damage due to water leakage or flooding:

- Read and follow all instructions before installation and use of this system.
- Change the disposable filter cartridge at the recommended interval, the disposable filter cartridge MUST be replaced every 6 months or sooner.
- Failure to replace the disposable filter cartridge at recommended intervals may lead to reduced filter performance and failure of the filter, causing property damage from water leakage or flooding.

IMPORTANT: See flushing instructions on next page.

HF20-A020-S-SR Cartridge Flow and Capacity Information

Head & Manifold	# of Cartridges	Flow Rate	Flush Instruction	Capacity
NH3 Series Head	1	2 gpm (7.6 lpm)	Flush 4.0 gals through cartridge(s) before use (flush approx. 2 mins)	N/A
VH3 Series Head	1	2 gpm (7.6 lpm)	Flush 4.0 gals through cartridge(s) before use (flush approx. 2 mins)	N/A
High Flow Series Twin 2XX Manifold	2	4 gpm (15.1 lpm)	Flush 8.0 gals through cartridge(s) before use (flush approx. 2 mins)	N/A
High Flow Series Triple 3XX Manifold	3	6 gpm (22.7 lpm)	Flush 12.0 gals through cartridge(s) before use (flush approx. 2 mins)	N/A
High Flow Series Single DF1XX Manifold	1	2 gpm (7.6 lpm)	Flush 4.0 gals through cartridge(s) before use (flush approx. 2 mins)	N/A
High Flow Series Twin DF2XX Manifold	2	4 gpm (15.1 lpm)	Flush 8.0 gals through cartridge(s) before use (flush approx. 2 mins)	N/A
High Flow Series Single DP1XX Manifold	1	2 gpm (7.6 lpm)	Flush 4.0 gals through cartridge(s) before use (flush approx. 2 mins)	N/A
High Flow Series Twin DP2XX Manifold	2	4 gpm (15.1 lpm)	Flush 8.0 gals through cartridge(s) before use (flush approx. 2 mins)	N/A
High Flow Series Triple DP3XX Manifold	3	6 gpm (22.7 lpm)	Flush 12.0 gals through cartridge(s) before use (flush approx. 2 mins)	N/A
High Flow Series Single SF1XX Manifold	1	2 gpm (7.6 lpm)	Flush 4.0 gals through cartridge(s) before use (flush approx. 2 mins)	N/A
High Flow Series DIDF2XX Manifold	2	4 gpm (15.1 lpm)	Flush 8.0 gals through cartridge(s) before use (flush approx. 2 mins)	N/A

Performance Data Sheet

Model: High Flow Series/HF20-S-SR

Use Replacement Cartridge: HF20-S-SR

The concentration of the indicated substances in water entering the system was reduced to a concentration less than or equal to the permissible limit for water leaving the system as specified in NSF/ANSI Standard 42, Standard 53 and CSA B483.1.



System tested and certified by NSF International against NSF/ANSI Standard 42, Standard 53 and CSA B483.1 for the reduction of substances as listed.

Substance Reduction	Average Influent	NSF specified Challenge Concentration	Avg % Reduction	Average Product Water Concentration	Max Permissible Product Water Concentration	NSF Reduction Requirements	NSF Test Report
Particulate Class I, 20.5 to <1.0 µm	3,433,333 pts/mL	At least 10,000 pts/mL	99.3%	22,100 pts/mL	N/A	≥ 85%	J-00304397
Cyst Reduction*	135,000 cysts/L	Minimum 50,000 cysts/L	99.99%	1 cyst/L	N/A	99.95%	J-00304396

Capacity: See chart on next page. Contaminant Reduction Determined by NSF testing.

FOR COMMERCIAL USE ONLY

Application Guidelines/Water Supply Parameters	
Service Flow	2.0 gpm (7.6 lpm)
Water Supply	Potable Water
Water Pressure	25 - 125 psi (172 - 862 kPa)
Water Temperature	40° F - 100° F (4.4° C - 38° C)

It is essential that the manufacturer's recommended installation, maintenance and filter replacement requirements be carried out for the product to perform as advertised. See System Installation Manual for Warranty information.

Note: While the testing was performed under standard laboratory conditions, actual performance may vary.

Replacement Cartridge: HF20-S-SR. For estimated costs of replacement elements please call 866.990.9785 or visit our website at www.3mpurification.com

Parts and service available from:



3M Purification Inc.
 400 Research Parkway
 St. Louis, MO 63165 U.S.A.
 Tel (866) 990-9785
 Tel (203) 237-5541
 Fax (203) 238-9701
www.3mpurification.com

3M is a trademark of 3M Company, used under license.
 © 2020 3M Company. All rights reserved.
 NSF is a trademark of NSF International

⚠ WARNING

To reduce the risk associated with ingestion of contaminants:

- Do not use with water that is microbiologically unsafe or of unknown quality without adequate disinfection before and after the system. Systems certified for cyst reduction may be used on disinfected water that may contain filterable cysts.

Read entire manual. Failure to follow all guides and rules could cause personal injury or property damage.

- Check with your local public works department for plumbing codes. You must follow their guidelines as you install the water filtration system.
- Your water filtration system will withstand up to 125 pounds per square inch (psi) water pressure. If your water supply pressure is higher than 80 psi, install a pressure reducing valve before installing the water filtration system.

NOTICE

To reduce the risk associated with property damage due to water leakage or flooding:

- Read and follow all instructions before installation and use of this system.
- Change the disposable filter cartridge at the recommended interval; the disposable filter cartridge MUST be replaced every 6 months or sooner.
- Failure to replace the disposable filter cartridge at recommended intervals may lead to reduced filter performance and failure of the filter, causing property damage from water leakage or flooding.

IMPORTANT: See flushing instructions on next page.

HF20-S-SR Cartridge Flow and Capacity Information

Head & Manifold	# of Cartridges	Flow Rate	Flush Instruction	Capacity
NH3 Series Head	1	2 gpm (7.6 lpm)	Flush 4.0 gals through cartridge(s) before use (flush approx. 2 mins)	N/A
VH3 Series Head	1	2 gpm (7.6 lpm)	Flush 4.0 gals through cartridge(s) before use (flush approx. 2 mins)	N/A
High Flow Series Twin 2XX Manifold	2	4 gpm (15.1 lpm)	Flush 8.0 gals through cartridge(s) before use (flush approx. 2 mins)	N/A
High Flow Series Triple 3XX Manifold	3	6 gpm (22.7 lpm)	Flush 12.0 gals through cartridge(s) before use (flush approx. 2 mins)	N/A
High Flow Series Single DF1XX Manifold	1	2 gpm (7.6 lpm)	Flush 4.0 gals through cartridge(s) before use (flush approx. 2 mins)	N/A
High Flow Series Twin DF2XX Manifold	2	4 gpm (15.1 lpm)	Flush 8.0 gals through cartridge(s) before use (flush approx. 2 mins)	N/A
High Flow Series Single DP1XX Manifold	1	2 gpm (7.6 lpm)	Flush 4.0 gals through cartridge(s) before use (flush approx. 2 mins)	N/A
High Flow Series Twin DP2XX Manifold	2	4 gpm (15.1 lpm)	Flush 8.0 gals through cartridge(s) before use (flush approx. 2 mins)	N/A
High Flow Series Triple DP3XX Manifold	3	6 gpm (22.7 lpm)	Flush 12.0 gals through cartridge(s) before use (flush approx. 2 mins)	N/A
High Flow Series Single SF1XX Manifold	1	2 gpm (7.6 lpm)	Flush 4.0 gals through cartridge(s) before use (flush approx. 2 mins)	N/A
High Flow Series DID/DF2XX Manifold	2	4 gpm (15.1 lpm)	Flush 8.0 gals through cartridge(s) before use (flush approx. 2 mins)	N/A

Performance Data Sheet

Model: High Flow Series/HF40-S-SR

Use Replacement Cartridge: HF40-S-SR

The concentration of the indicated substances in water entering the system was reduced to a concentration less than or equal to the permissible limit for water leaving the system as specified in NSF/ANSI Standard 42, Standard 53 and CSA B483. 1.



System tested and certified by NSF International against NSF/ANSI Standard 42, Standard 53 and CSA B483.1 for the reduction of substances as listed.

Substance Reduction	Average Influent	NSF specified Challenge Concentration	Avg % Reduction	Average Product Water Concentration	Max Permissible Product Water Concentration	NSF Reduction Requirements	NSF Test Report
Particulate Class I, ≥0.5 to <1.0 µm	3,433.333 pts/mL	At least 10,000 pts/mL	99.3%	22,100 pts/mL	N/A	≥ 85%	J-00304397
Cyst Reduction*	135,000 cyst/L	Minimum 50,000 cysts/L	99.99%	1 cyst/L	N/A	99.95%	J-00304396

* Based on the use of *Cryptosporidium parvum* oocysts

FOR COMMERCIAL USE ONLY

Application Guidelines/Water Supply Parameters	
Service Flow	2.5 gpm. (9.5 lpm)
Water Supply	Potable Water
Water Pressure	25 - 125 psi (1.72 - 862 kPa)
Water Temperature	40° F - 100° F (4.4° C - 38° C)

It is essential that the manufacturer's recommended installation, maintenance and filter replacement requirements be carried out for the product to perform as advertised. See System Installation Manual for Warranty information.

Note: While the testing was performed under standard laboratory conditions, actual performance may vary.

Replacement Cartridge: HF40-S-SR For estimated costs of replacement elements please call 866.990.9785 or visit our website at www.3mpurification.com

Parts and service available from:



3M Purification Inc.
400 Research Parkway
Minden, CT 06450, U.S.A.
Tel. (866) 990-9785
Fax (203) 226-9701
www.3mpurification.com

3M is a trademark of 3M Company used under license.
© 2020 3M Company. All rights reserved.
NSF is a trademark of NSF International

Capacity: See chart on next page. Contaminant Reduction Determined by NSF testing.

⚠WARNING

To reduce the risk associated with ingestion of contaminants:

- Do not use with water that is microbiologically unsafe or of unknown quality without adequate disinfection before and after the system. Systems certified for cyst reduction may be used on disinfected water that may contain filterable cysts.

Read entire manual. Failure to follow all guides and rules could cause personal injury or property damage.

- Check with your local public works department for plumbing codes. You must follow their guidelines as you install the water filtration system.
- Your water filtration system will withstand up to 125 pounds per square inch (psi) water pressure. If your water supply pressure is higher than 80 psi, install a pressure reducing valve before installing the water filtration system.

NOTICE

To reduce the risk associated with property damage due to water leakage or flooding:

- Read and follow all instructions before installation and use of this system.
- Change the disposable filter cartridge at the recommended interval; the disposable filter cartridge **MUST** be replaced every 12 months or sooner.
- Failure to replace the disposable filter cartridge at recommended intervals may lead to reduced filter performance and failure of the filter, causing property damage from water leakage or flooding.

IMPORTANT: See flushing instructions on next page.

HF40-S-SR Cartridge Flow and Capacity Information

Head & Manifold	# of Cartridges	Flow Rate	Flush Instruction	Capacity
NH3 Series Head	1	2.5 gpm (9.5 lpm)	Flush 5.0 gals through cartridge(s) before use (flush approx. 2 mins)	N/A
VH3 Series Head	1	2.5 gpm (9.5 lpm)	Flush 5.0 gals through cartridge(s) before use (flush approx. 2 mins)	N/A
High Flow Series Twin 2XX Manifold	2	5 gpm (18.9 lpm)	Flush 10.0 gals through cartridge(s) before use (flush approx. 2 mins)	N/A
High Flow Series Triple 3XX Manifold	3	7.5 gpm (28.4 lpm)	Flush 15.0 gals through cartridge(s) before use (flush approx. 2 mins)	N/A
High Flow Series Single DF1XX Manifold	1	2.5 gpm (9.5 lpm)	Flush 5.0 gals through cartridge(s) before use (flush approx. 2 mins)	N/A
High Flow Series Twin DF2XX Manifold	2	5 gpm (18.9 lpm)	Flush 10.0 gals through cartridge(s) before use (flush approx. 2 mins)	N/A
High Flow Series Single DP1XX Manifold	1	2.5 gpm (9.5 lpm)	Flush 5.0 gals through cartridge(s) before use (flush approx. 2 mins)	N/A
High Flow Series Twin DP2XX Manifold	2	5 gpm (18.9 lpm)	Flush 10.0 gals through cartridge(s) before use (flush approx. 2 mins)	N/A
High Flow Series Triple DP3XX Manifold	3	7.5 gpm (28.4 lpm)	Flush 15.0 gals through cartridge(s) before use (flush approx. 2 mins)	N/A
High Flow Series Single SF1XX Manifold	1	2.5 gpm (9.5 lpm)	Flush 5.0 gals through cartridge(s) before use (flush approx. 2 mins)	N/A
High Flow Series DIDE2XX Manifold	2	5 gpm (18.9 lpm)	Flush 10.0 gals through cartridge(s) before use (flush approx. 2 mins)	N/A

Performance Data Sheet

Model: High Flow Series/HF60-A020-S-SR

Use Replacement Cartridge: HF60-A020-S-SR

The concentration of the indicated substances in water entering the system was reduced to a concentration less than or equal to the permissible limit for water leaving the system as specified in NSF/ANSI Standard 42, Standard 53 and CSA B483.1.



System tested and certified by NSF International against NSF/ANSI Standard 42, Standard 53 and CSA B483.1 for the reduction of substances as listed.

US

Capacity: See chart on next page. Contaminant Reduction Determined by NSF testing.

Substance Reduction	Average Influent	NSF Specified Challenge Concentration	Avg % Reduction	Average Product Water Concentration	Max Permissible Product Water Concentration	NSF Reduction Requirements	NSF Test Report
Particulate Class I, 20.5 to <1.0 µm	3,433,333 pps/mL	At least 10,000 pps/mL	99.3%	22,100 pps/mL	N/A	≥ 85%	J-00304397
Cyst Reduction*	135,000 cysts/L	Minimum 50,000 cysts/L	99.99%	1 cyst/L	N/A	99.95%	J-00304396

* Based on the use of *Cryptosporidium parvum* oocysts

FOR COMMERCIAL USE ONLY

Application Guidelines	Water Supply Parameters
Service Flow	3.5 gpm (13.2 lpm)
Water Supply	Potable Water
Water Pressure	25 - 125 psi (1.72 - 862 kPa)
Water Temperature	40° F - 100° F (4.4° C - 38° C)

It is essential that the manufacturer's recommended installation, maintenance and filler replacement requirements be carried out for the product to perform as advertised. See System Installation Manual for Warranty information.

Note: While the testing was performed under standard laboratory conditions, actual performance may vary.

Replacement Cartridge: HF60-A020-S-SR. For estimated costs of replacement elements please call 866.990.9785 or visit our website at www.3Mpurification.com

Parts and service available from:



3M Purification Inc.
400 Research Parkway
Meriden, CT 06450, U.S.A.
Tel (866) 990-9785
Tel (203) 237-5541
Fax (203) 238-8701
www.3Mpurification.com

3M is a trademark of 3M Company used under license.
© 2020 3M Company. All rights reserved.
NSF is a trademark of NSF International

⚠ WARNING

To reduce the risk associated with ingestion of contaminants:

- Do not use with water that is microbiologically unsafe or of unknown quality without adequate disinfection before and after the system. Systems certified for cyst reduction may be used on disinfected water that may contain filterable cysts.

Read entire manual. Failure to follow all guides and rules could cause personal injury or property damage.

- Check with your local public works department for plumbing codes. You must follow their guidelines as you install the water filtration system.
- Your water filtration system will withstand up to 125 pounds per square inch (psi) water pressure. If your water supply pressure is higher than 80 psi, install a pressure reducing valve before installing the water filtration system.

NOTICE

To reduce the risk associated with property damage due to water leakage or flooding:

- Read and follow all instructions before installation and use of this system.
- Change the disposable filter cartridge at the recommended interval; the disposable filter cartridge **MUST** be replaced every 6 months or sooner.
- Failure to replace the disposable filter cartridge at recommended intervals may lead to reduced filter performance and failure of the filter, causing property damage from water leakage or flooding.

IMPORTANT: See flushing instructions on next page.

HF60-A020-S-SR Cartridge Flow and Capacity Information

Head & Manifold	# of Cartridges	Flow Rate	Flush Instruction	Capacity
NH3 Series Head	1	3.5 gpm (13.3 lpm)	Flush 7.0 gals through cartridge(s) before use (flush approx. 2 mins)	N/A
VH3 Series Head	1	3.5 gpm (13.3 lpm)	Flush 7.0 gals through cartridge(s) before use (flush approx. 2 mins)	N/A
High Flow Series Twin 2XX Manifold	2	7 gpm (26.5 lpm)	Flush 14.0 gals through cartridge(s) before use (flush approx. 2 mins)	N/A
High Flow Series Triple 3XX Manifold	3	10.5 gpm (39.8 lpm)	Flush 21.0 gals through cartridge(s) before use (flush approx. 2 mins)	N/A
High Flow Series Single DF1XX Manifold	1	3.5 gpm (13.3 lpm)	Flush 7.0 gals through cartridge(s) before use (flush approx. 2 mins)	N/A
High Flow Series Twin DF2XX Manifold	2	7 gpm (26.5 lpm)	Flush 14.0 gals through cartridge(s) before use (flush approx. 2 mins)	N/A
High Flow Series Single DP1XX Manifold	1	3.5 gpm (13.3 lpm)	Flush 7.0 gals through cartridge(s) before use (flush approx. 2 mins)	N/A
High Flow Series Twin DP2XX Manifold	2	7 gpm (26.5 lpm)	Flush 14.0 gals through cartridge(s) before use (flush approx. 2 mins)	N/A
High Flow Series Triple DP3XX Manifold	3	10.5 gpm (39.8 lpm)	Flush 21.0 gals through cartridge(s) before use (flush approx. 2 mins)	N/A
High Flow Series Single SF1XX Manifold	1	3.5 gpm (13.3 lpm)	Flush 7.0 gals through cartridge(s) before use (flush approx. 2 mins)	N/A
High Flow Series DIDF2XX Manifold	2	7 gpm (26.5 lpm)	Flush 14.0 gals through cartridge(s) before use (flush approx. 2 mins)	N/A

Performance Data Sheet

Model: High Flow Series/HF60-S-SR and HF60-S-SR5

Use Replacement Cartridge: HF60-S-SR and HF60-S-SR5

The concentration of the indicated substances in water entering the system was reduced to a concentration less than or equal to the permissible limit for water leaving the system as specified in NSF/ANSI Standard 42, Standard 53 and CSA B483.1.



System tested and certified by NSF International against NSF/ANSI Standard 42, Standard 53 and CSA B483.1 for the reduction of substances as listed.

NSF[®] US

Capacity: See chart on next page.

Contaminant Reduction: Determined by NSF testing.

Substance Reduction	Average Influent	NSF specified Challenge Concentration	Avg % Reduction	Average Product Water Concentration	Max Permissible Product Water Concentration	NSF Reduction Requirements	NSF Test Report
Particulate Class I, 20.5 to <1.0 µm	3,433,333 pps/mL	At least 10,000 pps/mL	99.3%	22,100 pps/mL	N/A	≥ 85%	J-00304397
Cyst Reduction*	135,000 cysts/L	Minimum 50,000 cysts/L	99.99%	1 cyst/L	N/A	99.95%	J-00304396

* Based on the use of *Cryptosporidium parvum* oocysts

FOR COMMERCIAL USE ONLY

Application Guidelines/Water Supply Parameters	
Service Flow	3.34 gpm (12.6 lpm)
Water Supply	Potable Water
Water Pressure	25 - 125 psi (172 - 862 kPa)
Water Temperature	40° F - 100° F (4.4° C - 38° C)

It is essential that the manufacturer's recommended installation, maintenance and filter replacement requirements be carried out for the product to perform as advertised. See System Installation Manual for Warranty information.

Note: While the testing was performed under standard laboratory conditions, actual performance may vary.

Replacement Cartridge: HF60-S-SR. For estimated costs of replacement elements please call 866.990.9785 or visit our website at www.3mpurification.com

Parts and service available from:



3M Purification Inc.
 400 Research Parkway
 Meriden, CT 06450, U.S.A.
 Tel (866) 990-9785
 (203) 237-5541
 Fax (203) 238-8701
www.3mpurification.com

3M is a trademark of 3M Company used under license.
 © 2020 3M Company. All rights reserved.
 NSF is a trademark of NSF International

⚠ WARNING

To reduce the risk associated with ingestion of contaminants:

- Do not use with water that is microbiologically unstable or of unknown quality without adequate disinfection before and after the system. Systems certified for cyst reduction may be used on disinfected water that may contain filterable cysts.

Read entire manual. Failure to follow all guides and rules could cause personal injury or property damage.

- Check with your local public works department for plumbing codes. You must follow their guidelines as you install the water filtration system.
- Your water filtration system will withstand up to 125 pounds per square inch (psi) water pressure. If your water supply pressure is higher than 80 psi, install a pressure reducing valve before installing the water filtration system.

NOTICE

To reduce the risk associated with property damage due to water leakage or flooding:

- Read and follow all instructions before installation and use of this system.
- Change the disposable filter cartridge at the recommended interval; the disposable filter cartridge **MUST** be replaced every 12 months or sooner.
- Failure to replace the disposable filter cartridge at recommended intervals may lead to reduced filter performance and failure of the filter, causing property damage from water leakage or flooding.

IMPORTANT: See flushing instructions on next page.

HF60-S-SR and HF60-S-SR5 Cartridge Flow and Capacity Information

Head & Manifold	# of Cartridges	Flow Rate	Flush Instruction	Capacity
NH3 Series Head	1	3.34 gpm (12.6 lpm)	Flush 6.68 gals through cartridge(s) before use (flush approx. 2 mins)	N/A
VH3 Series Head	1	3.34 gpm (12.6 lpm)	Flush 6.68 gals through cartridge(s) before use (flush approx. 2 mins)	N/A
High Flow Series Twin 2XX Manifold	2	6.68 gpm (25.3 lpm)	Flush 13.36 gals through cartridge(s) before use (flush approx. 2 mins)	N/A
High Flow Series Triple 3XX Manifold	3	10.02 gpm (37.9 lpm)	Flush 20.04 gals through cartridge(s) before use (flush approx. 2 mins)	N/A
High Flow Series Single DF1XX Manifold	1	3.34 gpm (12.6 lpm)	Flush 6.68 gals through cartridge(s) before use (flush approx. 2 mins)	N/A
High Flow Series Twin DF2XX Manifold	2	6.68 gpm (25.3 lpm)	Flush 13.36 gals through cartridge(s) before use (flush approx. 2 mins)	N/A
High Flow Series Single DP1XX Manifold	1	3.34 gpm (12.6 lpm)	Flush 6.68 gals through cartridge(s) before use (flush approx. 2 mins)	N/A
High Flow Series Twin DP2XX Manifold	2	6.68 gpm (25.3 lpm)	Flush 13.36 gals through cartridge(s) before use (flush approx. 2 mins)	N/A
High Flow Series Triple DP3XX Manifold	3	10.02 gpm (37.9 lpm)	Flush 20.04 gals through cartridge(s) before use (flush approx. 2 mins)	N/A
High Flow Series Single SF1XX Manifold	1	3.34 gpm (12.6 lpm)	Flush 6.68 gals through cartridge(s) before use (flush approx. 2 mins)	N/A
High Flow Series DIDF2XX Manifold	2	6.68 gpm (25.3 lpm)	Flush 13.36 gals through cartridge(s) before use (flush approx. 2 mins)	N/A

Performance Data Sheet

Model: High Flow Series/HF90-SR, HF90-S-SR, and HF90-S-SR5

Use Replacement Cartridge: HF90-SR, HF90-S-SR, or HF90-S-SR5

The concentration of the indicated substances in water entering the system was reduced to a concentration less than or equal to the permissible limit for water leaving the system as specified in NSF/ANSI Standard 42, Standard 53 and CSA B483.1.



System tested and certified by NSF International against NSF/ANSI Standard 42, Standard 53 and CSA B483.1 for the reduction of substances as listed.

US

Capacity: See chart on next page.

Contaminant Reduction Determined by NSF testing.

Substance Reduction	Average Influent	NSF Specified Challenge Concentration	Avg % Reduction	Average Product Water Concentration	Max Permissible Product Water Concentration	NSF Reduction Requirements	NSF Test Report
Particulate Class I, ≥0.5 to <1.0 µm	3,433.333 pts/mL	At least 10,000 pts/mL	99.3%	22,100 pts/mL	N/A	≥ 85%	J-00304397
Cyst Reduction*	135,000 cysts/L	Minimum 50,000 cysts/L	99.99%	1 cyst/L	N/A	99.95%	J-00304396

* Based on the use of *Cryptosporidium parvum* oocysts

FOR COMMERCIAL USE ONLY

Application Guidelines/Water Supply Parameters	
Service Flow	5.0 gpm (18.9 lpm)
Water Supply	Potable Water
Water Pressure	25 -125 psi (172 – 862 kPa)
Water Temperature	40° F - 100° F (4.4° C - 38° C)

It is essential that the manufacturer's recommended installation, maintenance and filter replacement requirements be carried out for the product to perform as advertised. See System Installation Manual for Warranty information.

Note: While the testing was performed under standard laboratory conditions, actual performance may vary.

Replacement Cartridge: HF90-SR, HF90-S-SR, or HF90-S-SR5. For estimated costs of replacement elements please call 866.990.9785 or visit our website at www.3Mpurification.com

Parts and service available from:



3M Purification Inc.
 400 Research Parkway
 Meriden, CT 06450, U.S.A.
 Tel (866) 990-9785
 (203) 237-5541
 Fax (203) 238-8701
www.3Mpurification.com

3M is a trademark of 3M Company used under license.
 © 2020 3M Company. All rights reserved.
 NSF is a trademark of NSF International

IMPORTANT: See flushing instructions on next page.

⚠WARNING

To reduce the risk associated with ingestion of contaminants:

- Do not use with water that is microbiologically unsafe or of unknown quality without adequate disinfection before and after the system. Systems certified for cyst reduction may be used on disinfected water that may contain filterable cysts.

Read entire manual. Failure to follow all guides and rules could cause personal injury or property damage.

- Check with your local public works department for plumbing codes. You must follow their guidelines as you install the water filtration system.
- Your water filtration system will withstand up to 125 pounds per square inch (psi) water pressure. If your water supply pressure is higher than 80 psi, install a pressure reducing valve before installing the water filtration system.

NOTICE

To reduce the risk associated with property damage due to water leakage or flooding:

- Read and follow all instructions before installation and use of this system.
- Change the disposable filter cartridge at the recommended interval; the disposable filter cartridge **MUST** be replaced every 12 months or sooner.
- Failure to replace the disposable filter cartridge at recommended intervals may lead to reduced filter performance and failure of the filter, causing property damage from water leakage or flooding.

HF90-SR/HF90-S-SR/HF90-S-SR5 Cartridge Flow and Capacity Information

Head & Manifold	# of Cartridges	Flow Rate	Flush Instruction	Capacity
NH3 Series Head	1	5 gpm (18.9 lpm)	Flush 10.0 gals through cartridge(s) before use (flush approx. 2 mins)	N/A
VH3 Series Head	1	5 gpm (18.9 lpm)	Flush 10.0 gals through cartridge(s) before use (flush approx. 2 mins)	N/A
High Flow Series Twin 2XX Manifold	2	10 gpm (37.9 lpm)	Flush 20.0 gals through cartridge(s) before use (flush approx. 2 mins)	N/A
High Flow Series Triple 3XX Manifold	3	15 gpm (56.8 lpm)	Flush 30.0 gals through cartridge(s) before use (flush approx. 2 mins)	N/A
High Flow Series Single DF1XX Manifold	1	5 gpm (18.9 lpm)	Flush 10.0 gals through cartridge(s) before use (flush approx. 2 mins)	N/A
High Flow Series Twin DF2XX Manifold	2	10 gpm (37.9 lpm)	Flush 20.0 gals through cartridge(s) before use (flush approx. 2 mins)	N/A
High Flow Series Single DP1XX Manifold	1	5 gpm (18.9 lpm)	Flush 10.0 gals through cartridge(s) before use (flush approx. 2 mins)	N/A
High Flow Series Twin DP2XX Manifold	2	10 gpm (37.9 lpm)	Flush 20.0 gals through cartridge(s) before use (flush approx. 2 mins)	N/A
High Flow Series Triple DP3XX Manifold	3	15 gpm (56.8 lpm)	Flush 30.0 gals through cartridge(s) before use (flush approx. 2 mins)	N/A
High Flow Series Single SF1XX Manifold	1	5 gpm (18.9 lpm)	Flush 10.0 gals through cartridge(s) before use (flush approx. 2 mins)	N/A
High Flow Series DIDF2XX Manifold	2	10 gpm (37.9 lpm)	Flush 20.0 gals through cartridge(s) before use (flush approx. 2 mins)	N/A



3M Purification Inc.
3M Separation and Purification
Sciences Division
400 Research Parkway
Meriden, CT 06450 USA

Phone 1-866-990-9785
WW 1-203-237-5541
Web 3Mfoodservice.com
3Mpurification.com

3M is a trademark of 3M Company.
All other trademarks are the property of
their respective owners.
© 2020 3M Company. All rights reserved.
34-8725-3186-7

