



**WARNING:**

THIS PEDAL IS NOT DESIGNED FOR USE ON ANY TYPE OF INDOOR EXERCISE BICYCLE OR EQUIPMENT.

Please read the pedal manual carefully and follow the guidelines to prevent accidents and possible injuries.

**COMPONENTS:**

1. Pedal (left & right)
2. Washer

**TOOLS NEEDED:**

-15mm open end wrench for mounting pedal to crank arms.

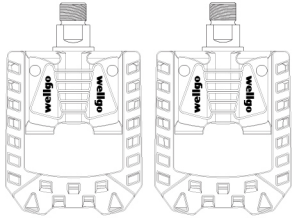

Pedal 2 pcs  
(left & right)





Washer  
2 pcs

## 1 PEDAL INSTALLATION

**Mounting pedals to crank arms**

Use a 15mm open end wrench to mount pedals to crank arms. The pedal axle is stamped with a "L" or "R" to denote left and right side respectively.

※ Right pedal has right-hand thread (Normal )

Left pedal has Left-hand thread (Reverse )

Recommended Torque:  
35 Nm or 25 ft-lbs

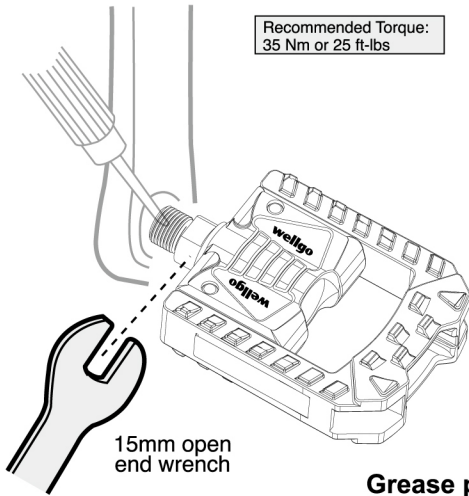

15mm open  
end wrench

**Grease pedal threads  
before installation  
to prevent corrosion.**

## 2 WASHER REPLACEMENT

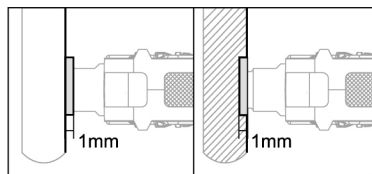

The washer could help better contact while install the pedal to crank arms

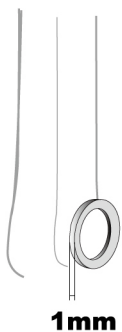

1mm

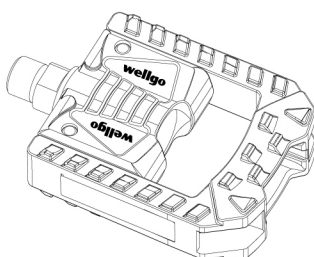

## 3 HOW TO FOLD THE PEDAL

1 Push the pedal to crank direction

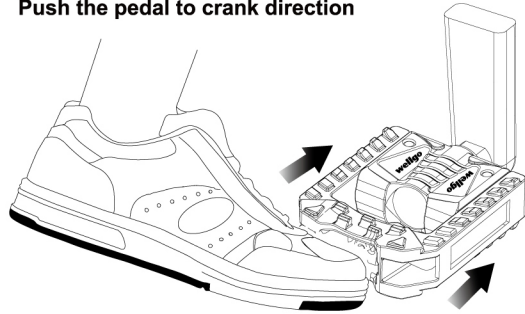

2 Folding the cage up or down

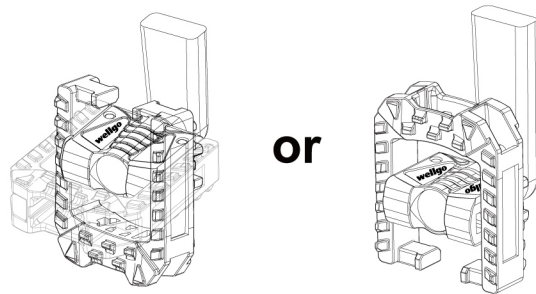

## 4 WAY TO OPEN

1 Push the cage in the direction as arrow shown

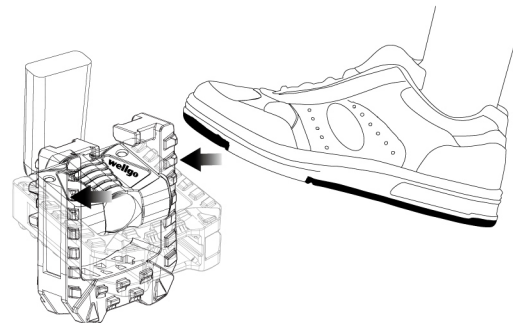

2 Or push up to the direction as arrow shown

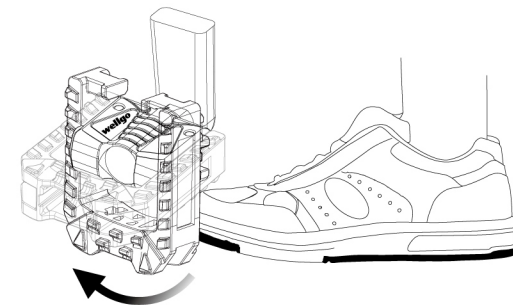

## NOTES

Factory warranty: one year from date of purchase

Warranty is only valid for defective design or production

Warranty conditions:

1. Original receipt of purchase must be shown for warranty service.
  2. When the returned product has no receipt, the warranty date will automatically be assumed to be the date of production. All warranties will be void if the pedals are damaged due to user crash, abuse, or body alterations, modification, or used in any way not intended as described in this user's guide.
- \* The specifications and design are subject to change without further notice.

If you have any questions, please contact your nearest authorised dealer.

For more information please go to [www.wellgopedal.com](http://www.wellgopedal.com)



警告：

此腳踏設計不適用於任何室內運動車或飛輪車種上。

請詳細閱讀踏板說明書並遵從指示來預防意外和可能的傷害。

包含的零件/工具：

- 踏板(左/右)
- 華司

安裝所需工具：

- 15mm開口扳手安裝踏板於曲柄上。

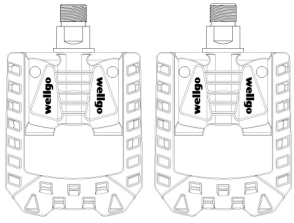

踏板左/右各一只



華司2只

## 1 踏板安裝

使用15mm開口扳手安裝踏板於曲柄上。  
踏板上有標明“L”或“R”字樣來表示左邊和右邊。

※註：

右(Right)邊踏板有著右牙紋(正向 )



左(Left)邊踏板有著左牙紋(反向 )



建議扭力：  
35Nm 或 25 ft-lbs

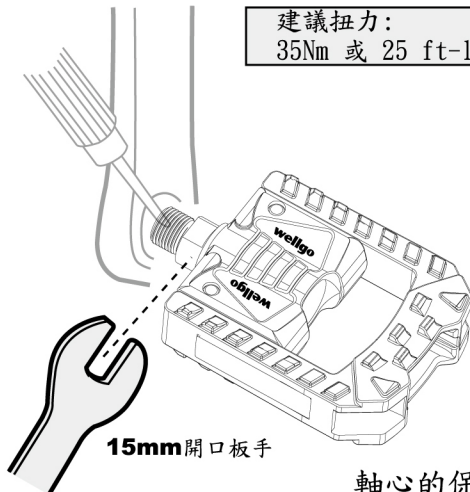

15mm開口扳手

軸心的保養  
清洗後請噴少許防銹油  
於軸心上油。

## 2 華司安裝

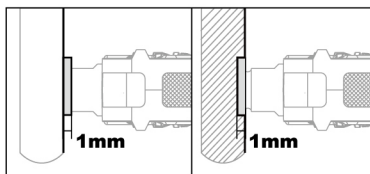

華司安裝增加踏板與曲柄鎖合力



1mm

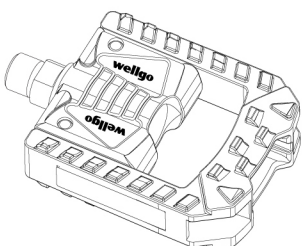

## 3

### 摺疊方式

1 踏板摺疊方式：以踏板外框為施力點，施力

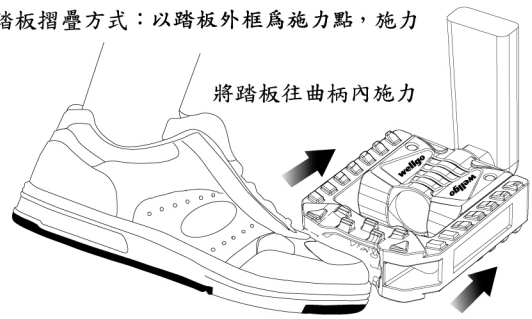

將踏板往曲柄內施力

2 將踏板向前推，再向上或向下即可

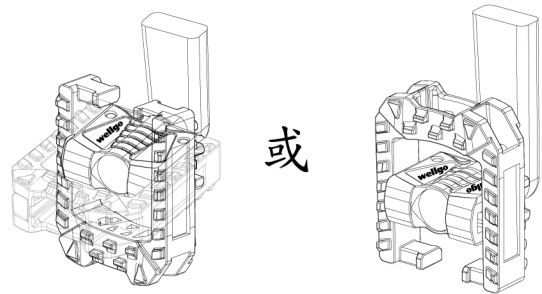

或

## 4

### 展開方式

1 方式一：依照箭頭所指示方向以腳底往內推

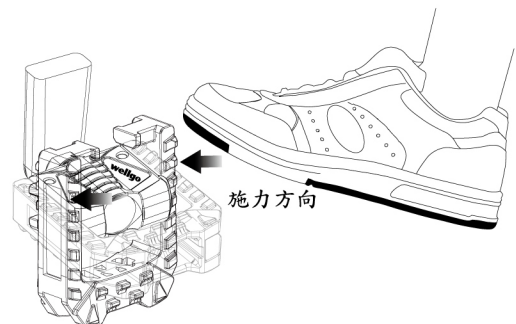

施力方向

2 方式二：依照箭頭所指示方向以腳往上勾

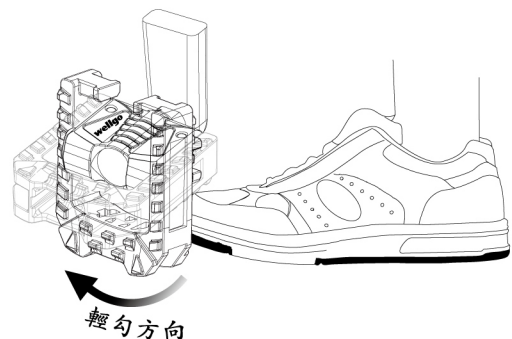

輕勾方向

### 注意事項

原廠保固期限：自購買日起一年只針對設計或製程上的不良提供保固

保固要求所需項目：

1. 要獲得保固服務，您必須擁有原購買收據。

2. 在退回的產品沒有收據的情況下，保固日期的開始日將自動認定為產品生產日期。

如果踏板因人為因素，或是在不當的使用情況而損壞，原廠將不提供保固服務。

\*產品規格與設計如果更改將不另行通知。

如您有任何問題，請聯絡您最近授權代理商。欲獲得更多訊息，請至 [www.wellgopedal.com](http://www.wellgopedal.com)