

The eBike Display
Users Manual

KD58C

Contents

Product name and model.....	1
Specifications.....	1
Appearance and Size.....	1
Function Summary and Button Definition.....	2
◆Function Summary.....	2
◆Button Definition.....	2
Installation.....	2
Function Area Distribution.....	2
General Operation.....	2
◆Switching the E-bike System On/Off.....	2
◆Display Interface.....	2
◆Switching Push-assist mode On/Off.....	3
◆Switching the Lighting On/Off.....	3
◆Assist Level Selection.....	3
◆Power Indicator.....	4
◆Error code Indication.....	4
General Settings.....	4
◆Trip Distance Clearance.....	5
◆Unit Mi/KM Conversion.....	5
◆Wheel Diameter Settings.....	5
◆Speed-limit Settings.....	6
◆Battery Power bar Settings.....	6
Personalized Parameter Settings.....	6
◆Power assist Level Settings.....	7
Power assist Level option.....	7
PAS Ratio settings.....	7
◆Controller Over-current Cut Settings.....	8
◆Power assist Sensor Settings.....	8
◆Speed Sensor Settings.....	8
◆Slow Start up Settings.....	9
◆Backlight Contrast Settings.....	9

◆Power-on Password Settings.....	10
Power-on Password Enable/Disable.....	10
Power-on Password Modify.....	10
◆Exit settings.....	10
Recover default settings.....	11
Quality assurance and warranty scope.....	11
Connection layout.....	12
Warnings.....	12
Attached list 1 Error code definition.....	13
Attached list 2 PAS ratio default value table.....	13

Product name and Model

Electric Bicycle Intelligent Display,
Model: KD58C.

Specifications

- 24V/36V /48V Power Supply
- Rated current: 10mA
- The maximum working current: 30mA
- Off-state leakage current: $<1\mu\text{A}$
- Working temperature: $-20 \sim 60\text{ }^{\circ}\text{C}$
- Storage temperature: $-30 \sim 70\text{ }^{\circ}\text{C}$

Appearance and Size

Product appearance and dimensional drawing (unit: mm)

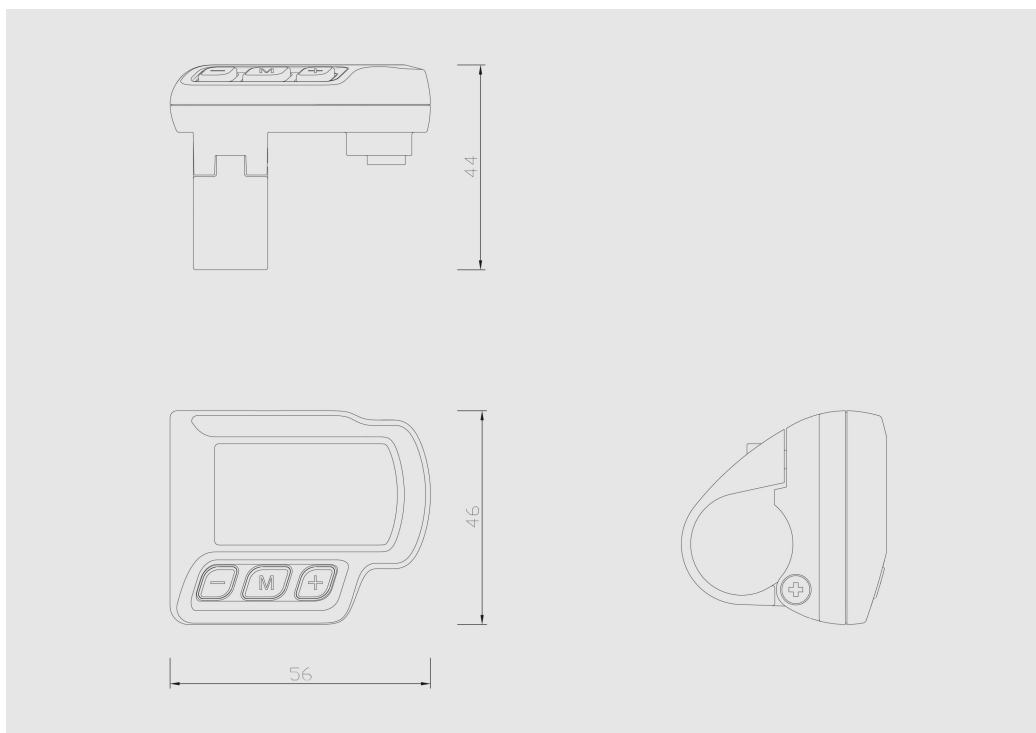

Function Summary and Button Definition

◆Function Summary

KD58C has a lot of functions to meet the users' needs. The indicating contents are as follows:

- Smart Battery
- Assist-level
- Speed indication (incl. running speed, max speed and average speed)
- Motor-output indicator
- Trip time
- Trip distance and Total distance
- The push-assist function
- The Lighting On/Off
- Error Code indication
- Various Parameters Settings (e.g., *wheel size, speed-limited, battery level bar, PAS level, password enable, controller limited current etc.*)
- Recover Default Settings

◆Button Definition

There are three buttons ( ,  , ) on the KD58C display that represent functions respectively: **ON/OFF**, **UP** and **DOWN**.

Installation

KD58C can be mounted on the left side of handlebar close to its grip. Adjust the angle for a good display view. Cut off the power before connecting the corresponding connectors between display and controller..

Function Area Distribution

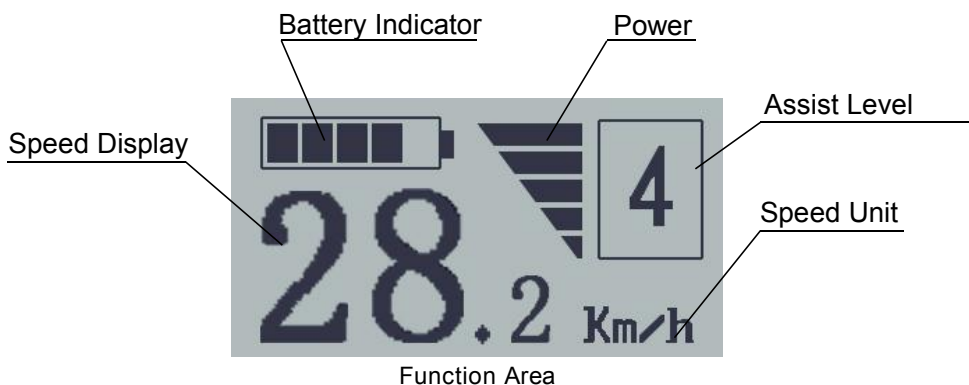

General Operation

◆Switching the E-bike system On/Off

To switch on the E-bike system, hold the **ON/OFF** button for 2 s.

Likewise, hold **ON/OFF** button for 2 s again, the E-bike system will be switched off.

When E-bike system is switched off, the leakage current is less than 1 μ A.

■When E-bike is parked for more than 10 minutes, the E-bike system will be switched off automatically.

◆Display Interface

After the E-bike system is switched on, the display shows current speed by default. To change the indicating information, press **ON/OFF** to show in turn: Current Speed (Km/h) → Trip Distance (Km) → ODO(Km) → Trip Time (Hour) → Average Speed (Km/h)

→ Max Speed (Km/h). Each state will display for 2 seconds and then automatically returns to current speed interface.

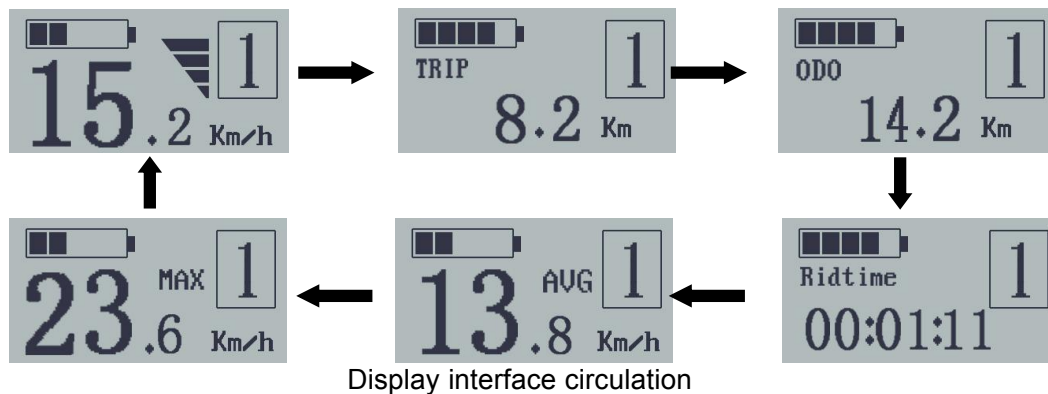

◆ **Switching Push-assist Mode On/Off**

To access the push-assist mode, hold the **DOWN** button for 2 s, the E-bike will go on at a uniform speed of 6 Km/h and “P” is showed on the screen at the same time. The push-assist function is switched off as soon as you release the **DOWN** button.

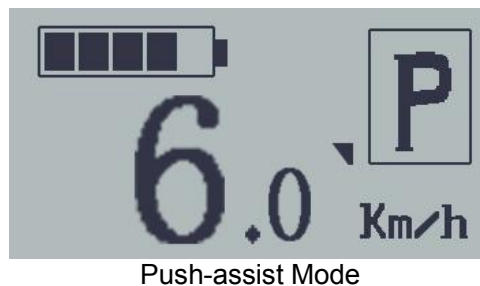

Push-assist Mode

■ **Push-assist function may only be used when pushing the E-bike. Be aware of danger of injury when the wheels of the E-bike do not have ground contact.**

◆ **Switching the Lighting On/Off**

To switch on headlight of the E-bike, hold the **UP** button for 2 s the headlight will be switched on while display backlight darkens.

Likewise, hold the **UP** button for 2 s again, the bike headlight will be switched off while display backlight is gaining brightness.

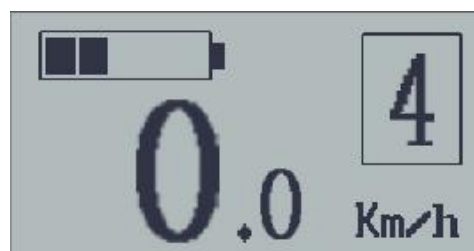

Switch the Lighting on/off

◆ **assist Level options**

Assist levels indicate the output power of the motor. The default value is level “1”.

The default power ranges from level “0” to level “5”. The output power is zero on Level “0”. Level “1” is the minimum power. Level “5” is the maximum power.

Press **UP/DOW** to change assist level as per your needs.



assist Level "4"

◆ Power Indicator

The output power of the motor can be indicated by below interface.



Motor Power Interface

◆ Error code Indication

If an error occurs in the electronic control system, the error code will appear automatically. See error code definitions in **Attached list 1**.

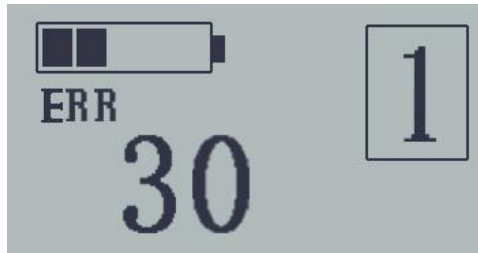

Error Code Indication

■ **Show the display to a Service Center when an error code appears. Or else you will not be able to ride the bike normally.**

General Settings

After the E-bike system is switched on, to access general settings menu, hold both the **UP** and **DOWN** button simultaneously for 2 s.

Press the **Up** or **DOWN** button to choose setting items, press **ON/OFF** to confirm the corresponding settings.

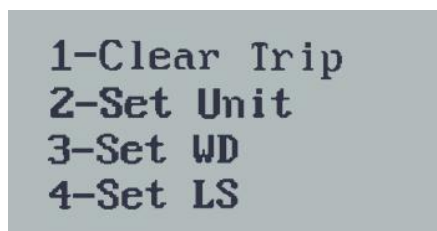



2-Set Unit
3-Set WD
4-Set LS
5-Set Volagte

General settings interface

◆ Trip Distance Clearance

Clear Trip means trip distance clearance. Press the **UP** or **DOWN** button to choose YES or NO to clear the trip distance. The default value is NO. If you choose YES and press the **ON/OFF** button to confirm the option, the display will show 'OK' and return to the general settings interface. Otherwise the display will return to the general settings interface directly.



Clear Trip
YES/NO

Trip distance clearance

◆ Unit Mile/KM Conversion

Set Unit represents unit settings.

To convert unit, press **UP/DOWN** to increase or decrease until the desired setting is displayed.

To store a changed setting, press the **ON/OFF** button to access trip distance clearance settings and the display will show 'OK' then returns to general settings interface. The default value is Metric.

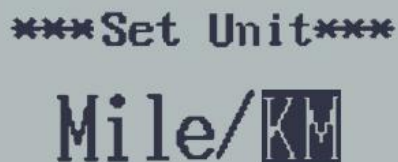

Set Unit
Mile/KM

Mile and Kilometer Conversion Settings Interface

◆ Wheel Diameter Settings

Set WD represents wheel diameter settings. Optional values are 16, 18, 20, 22, 24, 26, 700C and 28. The default value is 26 inch.

To change basic settings, press **UP/DOWN** to increase or decrease until the desired value is displayed.

To store a changed setting, press the **ON/OFF** button and the display will show 'OK' then returns to general settings interface.



Wheel Diameter Settings Interface

◆Speed-limit Settings

Set LS represents limited speed settings. When the running speed is faster than limited speed, the E-bike system will be switched off automatically. Limited speed range is 12Km/h to 40Km/h. The default value is 25Km/h.

To change basic settings, press **UP/DOWN** to increase or decrease until the desired value is displayed.

To store a changed setting, hold **ON/OFF** for 2 s and the display will show 'OK' then returns to general selection settings interface.



Limit Speed Settings Interface

◆Battery Power bar Settings

VOL represents voltage settings. Each bar represents a voltage value. 5 bars voltage values must be entered one by one. For example, VOL 1 is the first bar voltage value, the default value is 31.5V.

To set battery power bar, press **UP/DOWN** to increase or decrease the number.

To store a changed setting and access the second bar, press the **ON/OFF** button.

Likewise, after 5 bars voltage values are entered, hold **ON/OFF** for 2 s to confirm and return to the previous menu.



Battery Power Bar Settings

Personalized Parameter Settings(*Specific Set*)

Personalized Parameter Settings(*Specific Set*) can match various requirements in use.

Hold both **UP** and **DOWN** button for 2s to enter **general settings** and hold the **UP** and **DOWN** button for 2s again to enter personalized parameter settings selection interface. Press the **UP** or **DOWN** button to choose the personalized parameter settings items, then press the **ON/OFF** button to enter the corresponding settings interface.

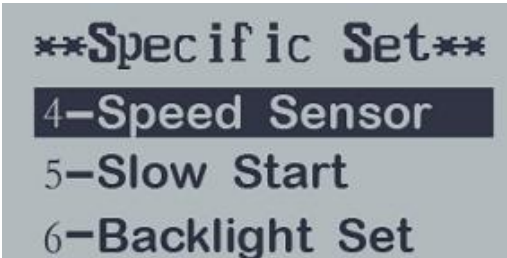
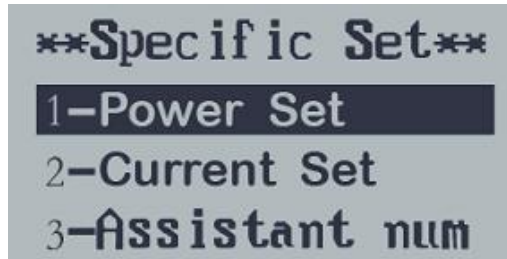

Personalized parameter settings Interface

◆ **Power assist Level Settings**

Power Set means power assist level settings

Power assist Level mode

In assist level settings, there are 8 modes for your choice: 0-3, 1-3, 0-5, 1-5, 0-7, 1-7, 0-9, 1-9. The default value is 0-5.

To select the mode of assist level, press **UP/DOWN** to increase or decrease until the desired assist level mode is displayed.

To store the changed setting and access the PAS ratio settings page, press the **ON/OFF** button.

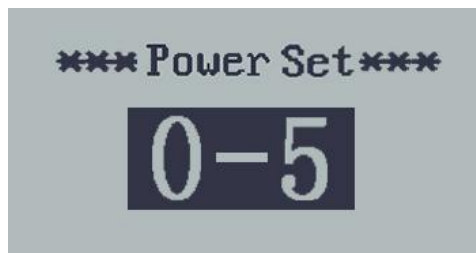

PAS mode option interface

PAS Ratio settings

To modify the value of PAS ratio can meet bikers' different requirements.

For example, the range is "45-55 percent" for PAS level 1, ratio value can be modified and the default is 50 percent.

Press the **UP** or **DOWN** button to increase or decrease the number. Press the **ON/OFF** button to confirm and move to the next PAS level ratio settings. Level 9 is the maximum. After all PAS ratios are input, hold the ***DOWN button** to confirm and return to personalized parameter settings(Specific Set) items interface. For various symbol definitions, please refer to **Attached list 2**.



PAS Ratio Interface

◆ Controller Over-current Cut Settings

Current Set represents controller over-current cut settings. The current value can be changed from 7.0A to 25.0A.

To change basic settings, press the "+" or the "-" button to increase or decrease the value of the current.

To store a changed setting, hold the "ON/OFF" button and then return to previous menu.



Current Settings Interface

◆ Power assist Sensor Settings

Assistant num represents PAS sensitivity settings. The sensitivity value is "5" to "24".

To store a changed setting, press the "ON/OFF" button and then return to previous menu.

To change PAS sensitivity settings, press the "+" or the "-" button to choose the desired sensitivity value.

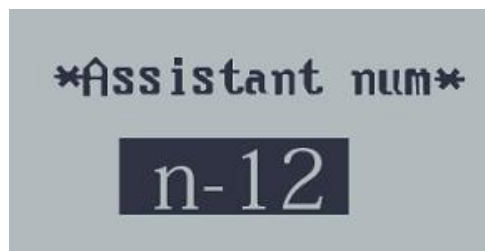

The PAS Sensitivity Settings

◆Speed Sensor Settings

Speed Sensor represents speed sensor settings. The default value is 1

To change speed sensor settings, press the “+” or the “-” button to choose the quantity of magnet heads (the range is from 1 to 15).

To store a changed setting, hold the “**ON/OFF**” button and then return to previous menu.



Speed Sensor Selection

◆Slow Start up Settings

Slow Start represents slow start up. The range is 1-4 seconds, 4 is the slowest.

To change slow start up settings, press the **UP** or **DOWN** button to change the value and press the **ON/OFF** button to confirm. The display will show 'OK' and return to previous menu interface. The default value is 1.



Slow Start up settings interface

◆Backlight Brightness Settings

Backlight Set represents backlight brightness settings. Level “1” is the low brightness, Level “3” is high brightness. The default level is “2”.

To modify the backlight brightness, press the “+” button or the “-” button to choose the desired brightness.

To store a changed setting, press the “**ON/OFF**” button and return to previous menu interface.



Backlight Brightness Settings Interface

◆ Power-on Password Settings

P2:0000 represents power-on password settings. The default password is 1212.

After accessing the power-on password settings, press **UP/DOWN** to modify the value and press **ON/OFF** to confirm digit one by one until the correct 4-digit password is completed. Then press **ON/OFF** to access power-on password enable settings interface, otherwise stay still in the password input state.



Power-on Password Entry Interface

Power-on Password Enable/Disable

Press the **UP** or **DOWN** button to choose Disable or Enable and press the **ON/OFF** button to confirm. The default value is Enable. If you choose Enable, press the **ON/OFF** button to enter Power-on Password Modify interface, otherwise exit the power-on password settings interface.



Power-on Password Disable/Enable Interface

Power-on Password Change

When the display shows "Password Set, P3", press the **UP** or **DOWN** button to modify the value and then press the **ON/OFF** button to confirm digit one by one until the new 4-digit password is completed.

To store the new power-on password, hold the **ON/OFF** button for 2 seconds and then exit settings.

When you switch on the E-bike system next time, the display will show P1,0000, please input the new password to power on.



Power-on Password Change Interface

◆ Exit settings

In the settings state, press the **ON/OFF** button to confirm the input. Hold the **ON/OFF** button for 2 s to save the settings and then exit the current settings. Hold the **DOWN** button for 2 s to cancel the operating but not saving the settings data, and then return to previous menu.

■If there is not any operations in one minute, display will exit the settings state automatically.

Recover default settings

dEF means recover default settings. Press both the **UP** and **ON/OFF** button for 2 s to enter recover default settings. Press the **UP** or **DOWN** button to choose Y or N. Y means that recovers default settings. N means that do not recover default settings. When it is Y, hold the **ON/OFF** button for 2 s to recover default settings, the display shows dEF-00 at the same time, and then return to general display state. The default value is N.



Recover Default Settings Interface

Quality assurance and warranty scope:

I. Warranty:

- 1) The warranty will be valid only for products used in normal usage and conditions.
- 2) The warranty is valid for 24 months after the shipment or delivery to the customer.

II. The following cases do not belong to warranty scope:

- 1) The display is demolished.
- 2) The damage of the display is caused by wrong installation or operation.
- 3) The shell of the display is broken after the display is out of the factory.
- 4) The cable of the display is broken.
- 5) Beyond warranty period.
- 6) The fault or damage of the display is caused by the force majeure (e.g., fire, earthquake, etc.).

Wire connection layout

Connector wire sequence

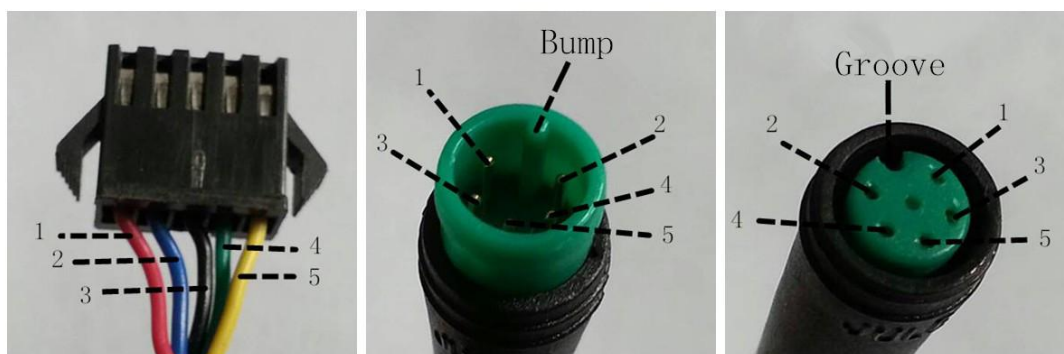

Connector to controller

display end

connection wire end to display

Wire sequence table

Wire sequence	Color	Function
1	Red(VCC)	+
2	Blue(K)	Lock
3	Black(GND)	-
4	Green(RX)	RX
5	Yellow(TX)	TX

■ Some products have wire connection with water-proof connectors, users can not see the color of wires in the harness.

Warnings:

1. Use the display with caution. Don't attempt to release or link the connector when battery is on power.
2. Try to avoid hitting the display.
3. Don't modify system parameters to avoid parameter disorder.
4. Make the display repaired when an error code appears.

■ THIS MANUAL INSTRUCTION IS A GENERAL-PURPOSE VERSION. SOME OF THE VERSIONS FOR THE DISPLAY SOFTWARE WILL BE DIFFERENT FROM SPECIFICATION TO SPECIFICATION. PLEASE ALWAYS REFER TO AN ACTUAL VERSION

Attached list 1: Error code definition

Error Code	Definition
21	Current Abnormality
22	Throttle Abnormality
23	Motor Phase Abnormality
24	Motor Hall Signal Abnormality
25	Brake Abnormality
30	Communication Abnormality

Attached list 2: PAS ratio default value table

Level PAS level mode	1	2	3	4	5	6	7	8	9
0-3/1-3	50%	74%	92%	—	—	—	—	—	—
0-5/ 1-5	50%	61%	73%	85%	96%	—	—	—	—
0-7/ 1-7	40%	50%	60%	70%	80%	90%	96%	—	—
0-9/ 1-9	25%	34%	43%	52%	61%	70%	79%	88%	96%