

MODEL # ERK-EDI-FS

FAN-SHAPED-ELECTRIC LIFTING DESK

BUREAU ÉLÉVATEUR ÉLECTRIQUE EN FORME D'ÉVENTAIL

MESA ELEVADORA ELÉCTRICA EN FORMA DE ABANICO

扇形电动升降桌

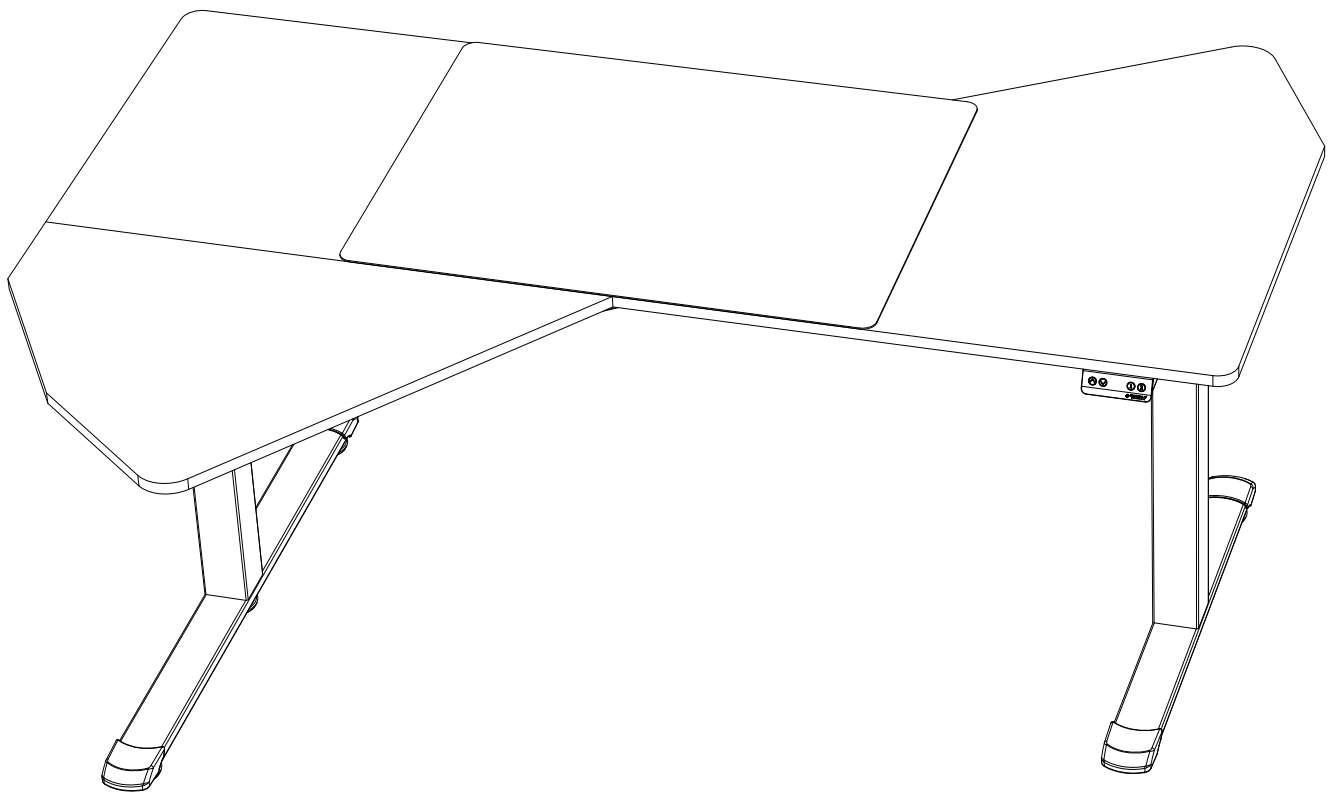

If you need to return the goods, please keep all the packaging materials and return it in the original packaging!

Si vous devez retourner la marchandise, veuillez conserver tous les matériaux d'emballage et le retourner dans l'emballage d'origine!

Si necesita devolver los productos, conserve todos los materiales de embalaje y devuélvalos en el embalaje original!

如需退货请保留好所有包装材料，并按原包装包好退回!

PARTS / PIÈCES / PARTES / 部件清单

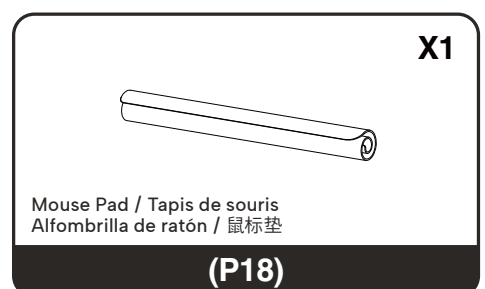
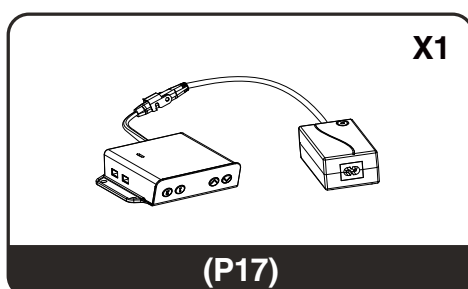
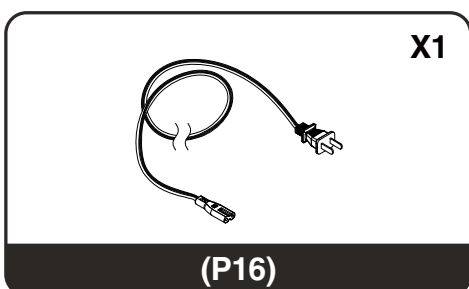
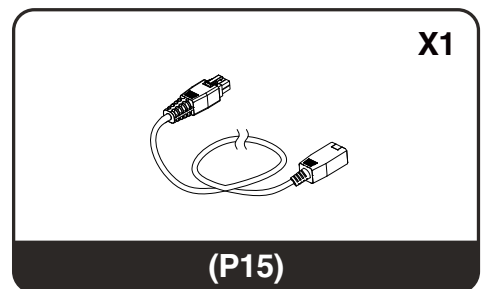
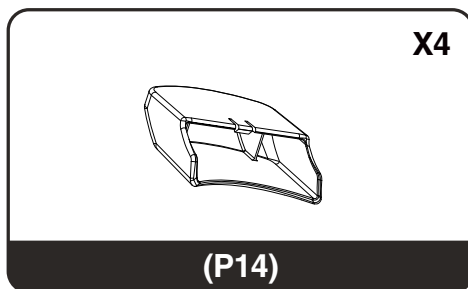
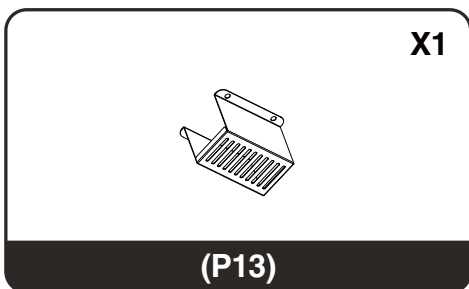
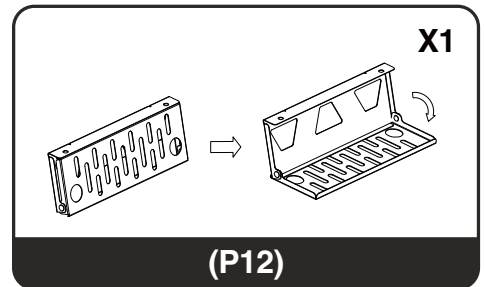
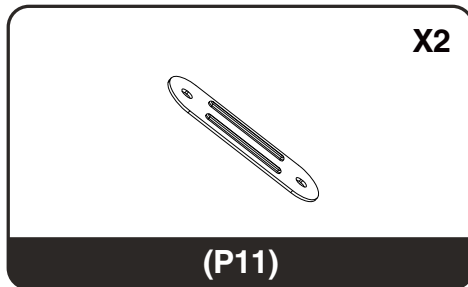
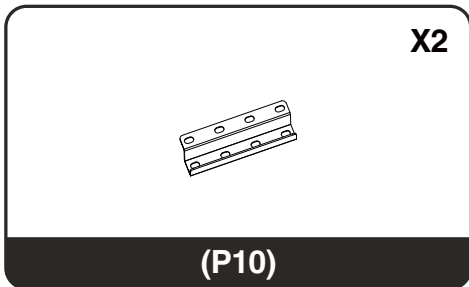
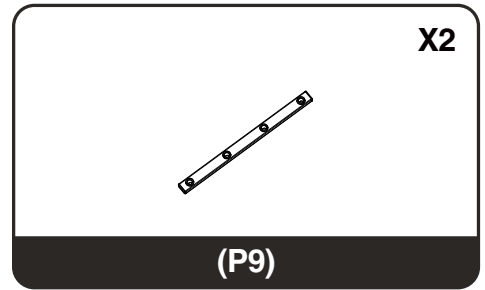
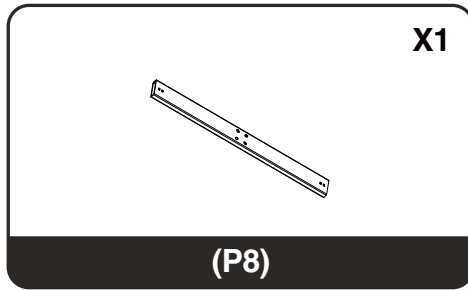
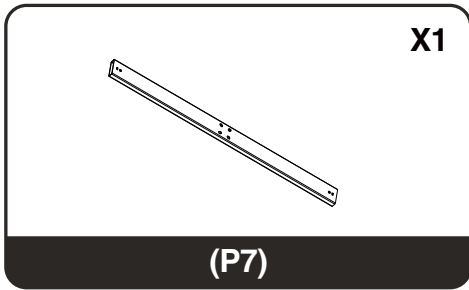
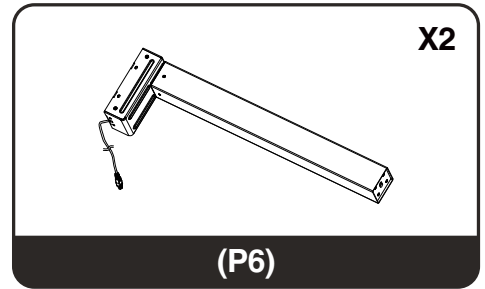
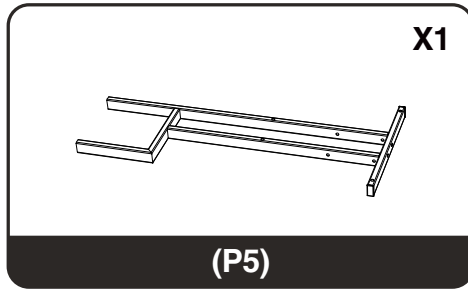
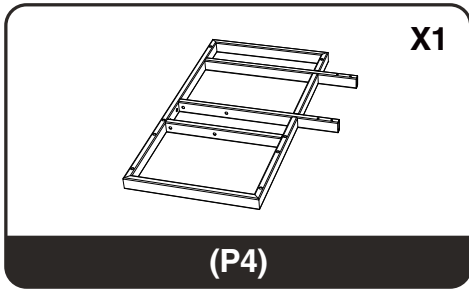
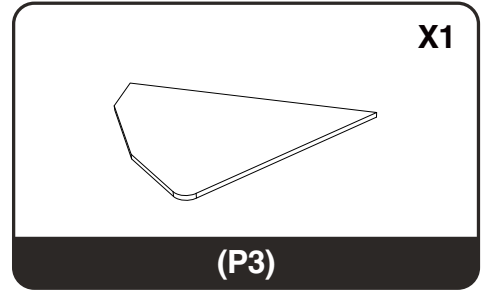
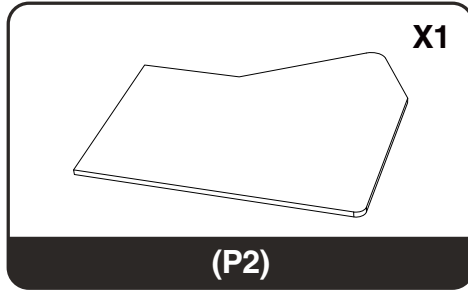
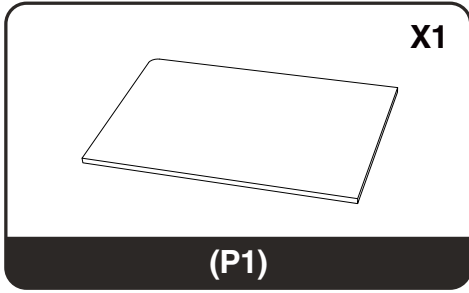

HARDWARE / MATÉRIEL / HARDWARE / 配件清单

M8*35mm X20

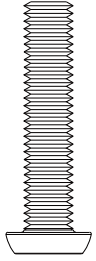

(A)

1/4*12mm X30

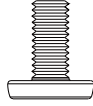

(B)

1/4*51mm X12

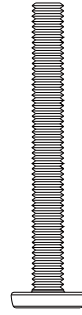

(C)

K4 X1

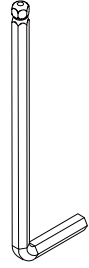

(D)

K5 X1

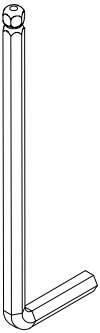

(E)

X5

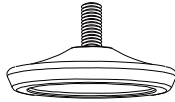

(F)

X5



(G)

X1

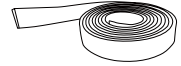

(H)

X5

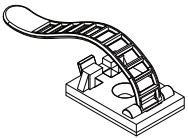

(I)



Do not tighten the screws until all of them are screwed into the holes.

Ne serrez pas les vis avant qu'elles ne soient toutes vissées dans les trous.

No apriete los tornillos hasta que todos estén atornillados en los agujeros.

安装时先不要把螺丝拧紧, 等所有螺丝都拧到螺纹孔上再将全部螺丝拧紧。

ASSEMBLY INSTRUCTIONS

INSTRUCTIONS DE MONTAGE

INSTRUCCIONES DE MONTAJE

安装步骤

STEP 1

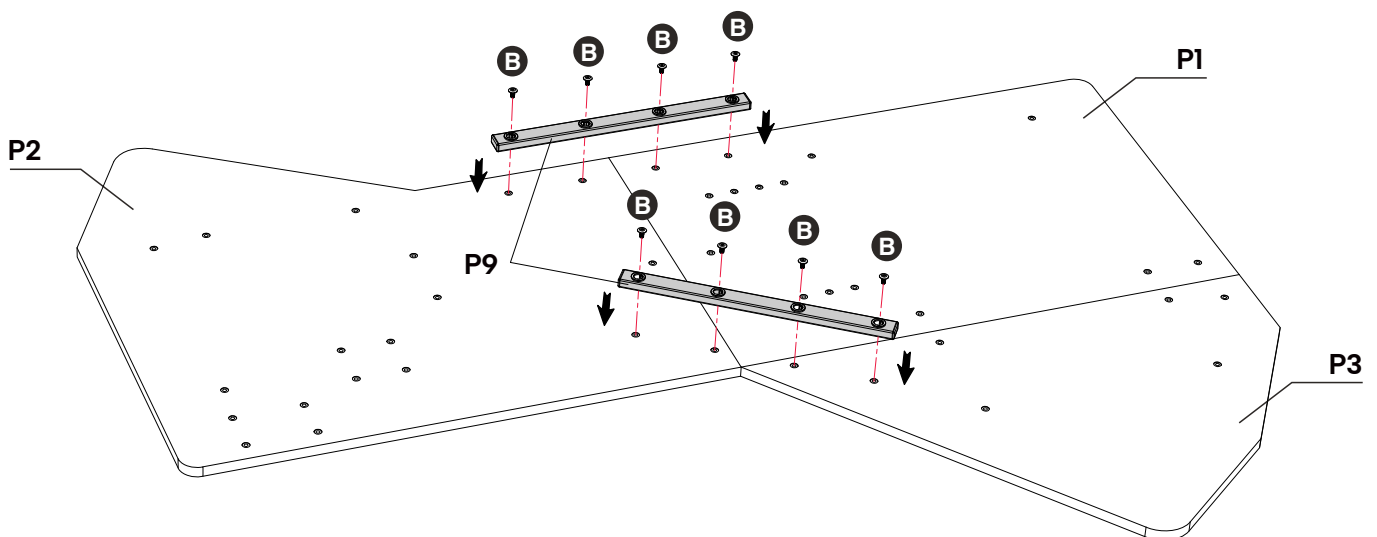
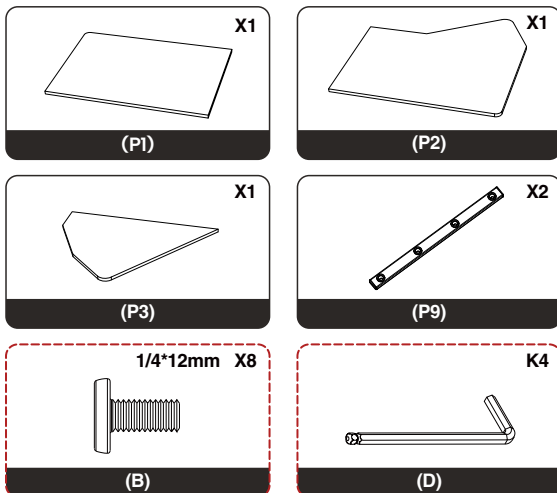

STEP 2

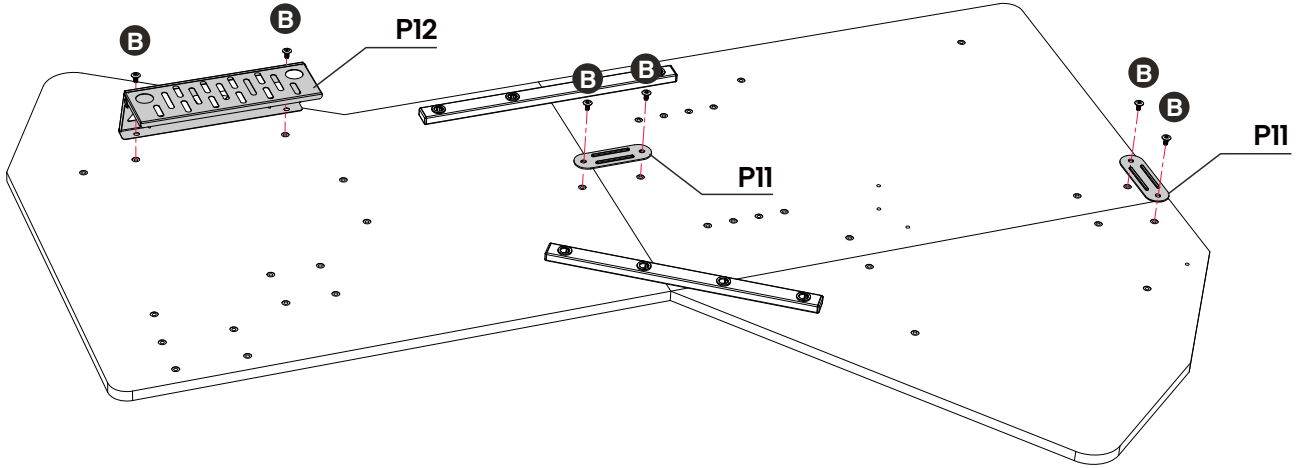
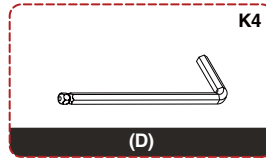
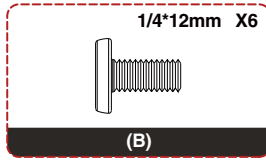
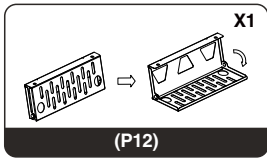
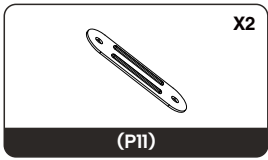

STEP 3

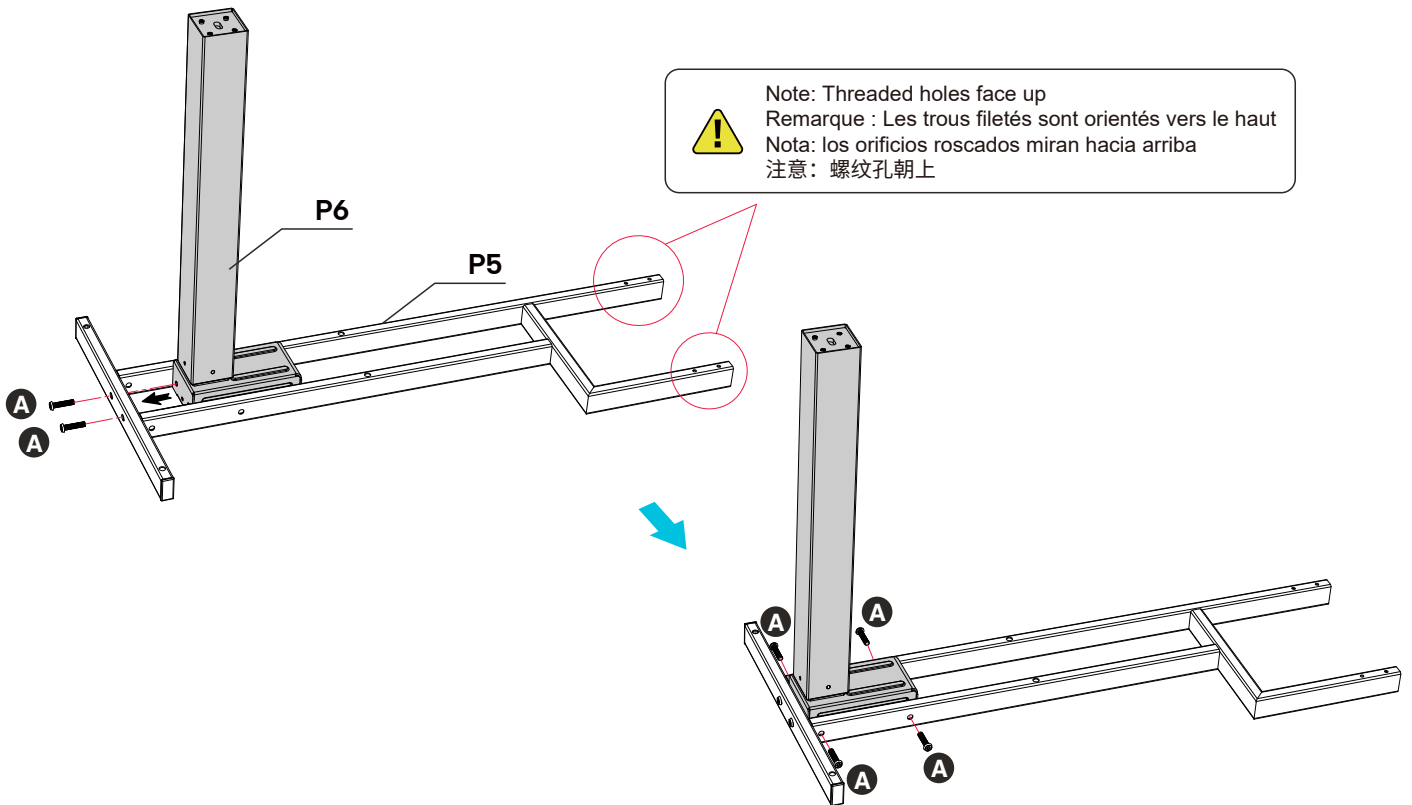
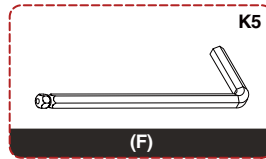
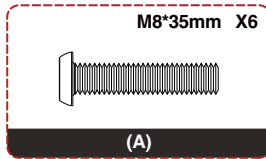
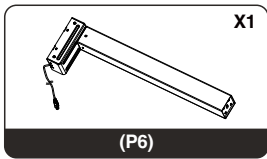
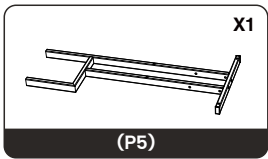

STEP 4

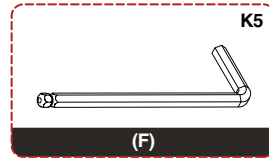
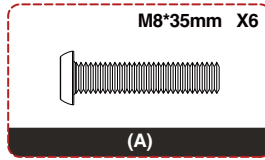
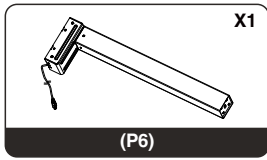
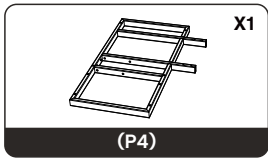

! Note: Threaded holes face up
 Remarque : Les trous filetés sont orientés vers le haut
 Nota: los orificios roscados miran hacia arriba
 注意: 螺纹孔朝上

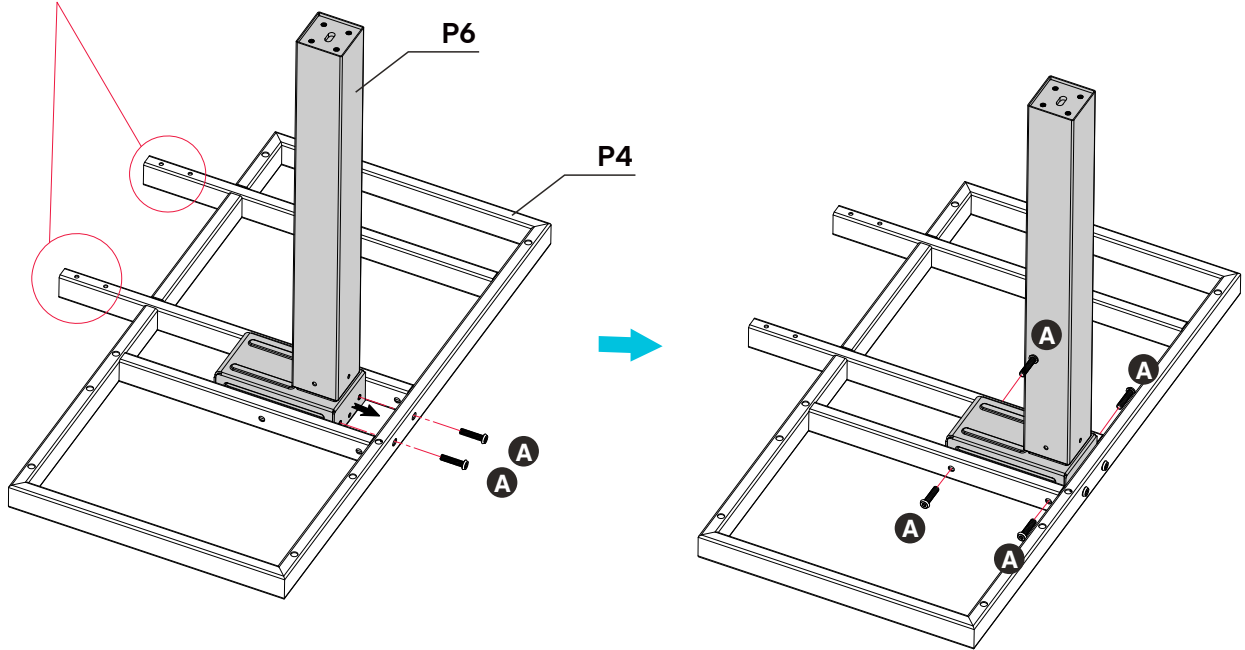

STEP 5

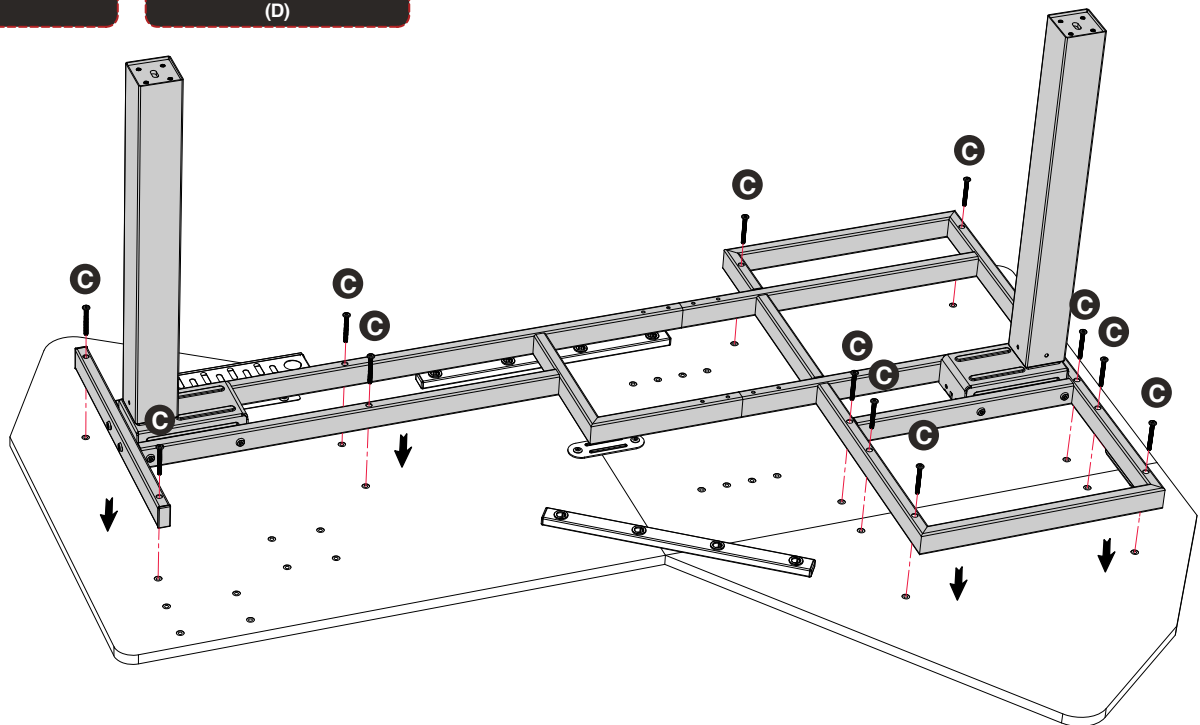
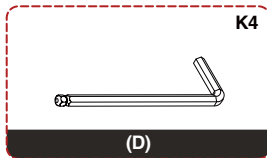
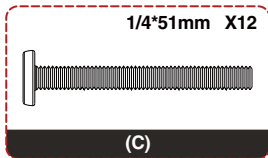

STEP 6

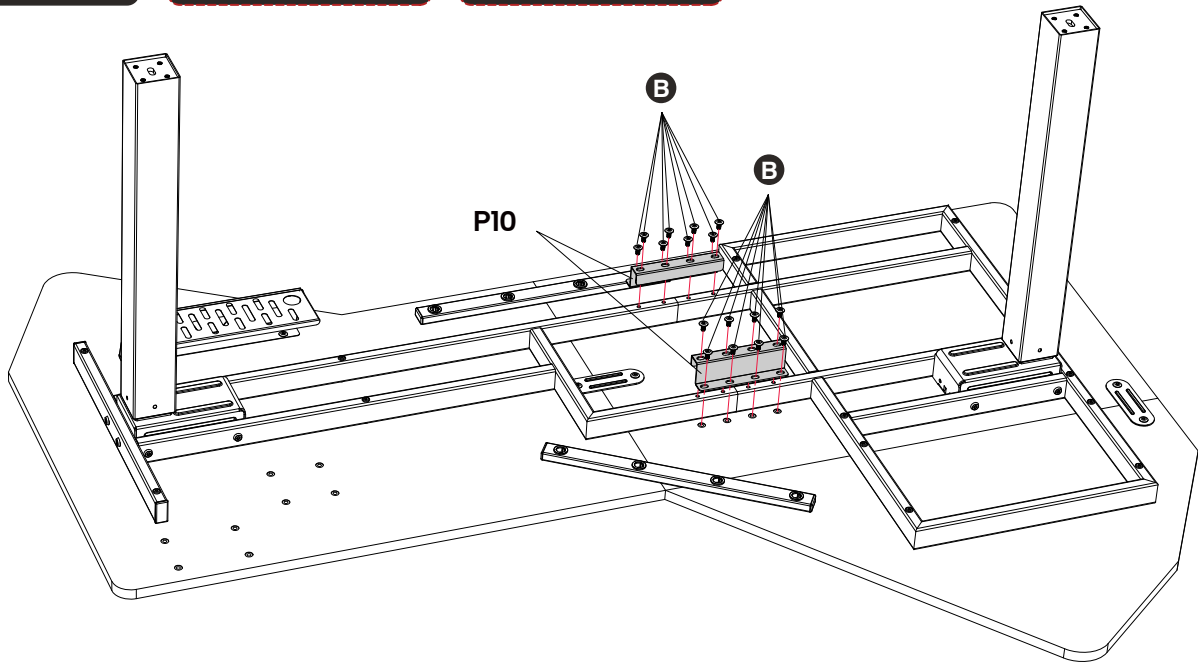
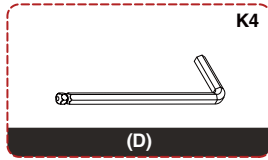
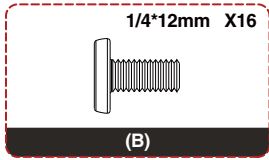
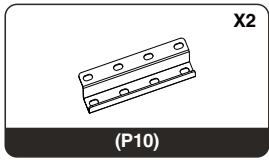

STEP 7

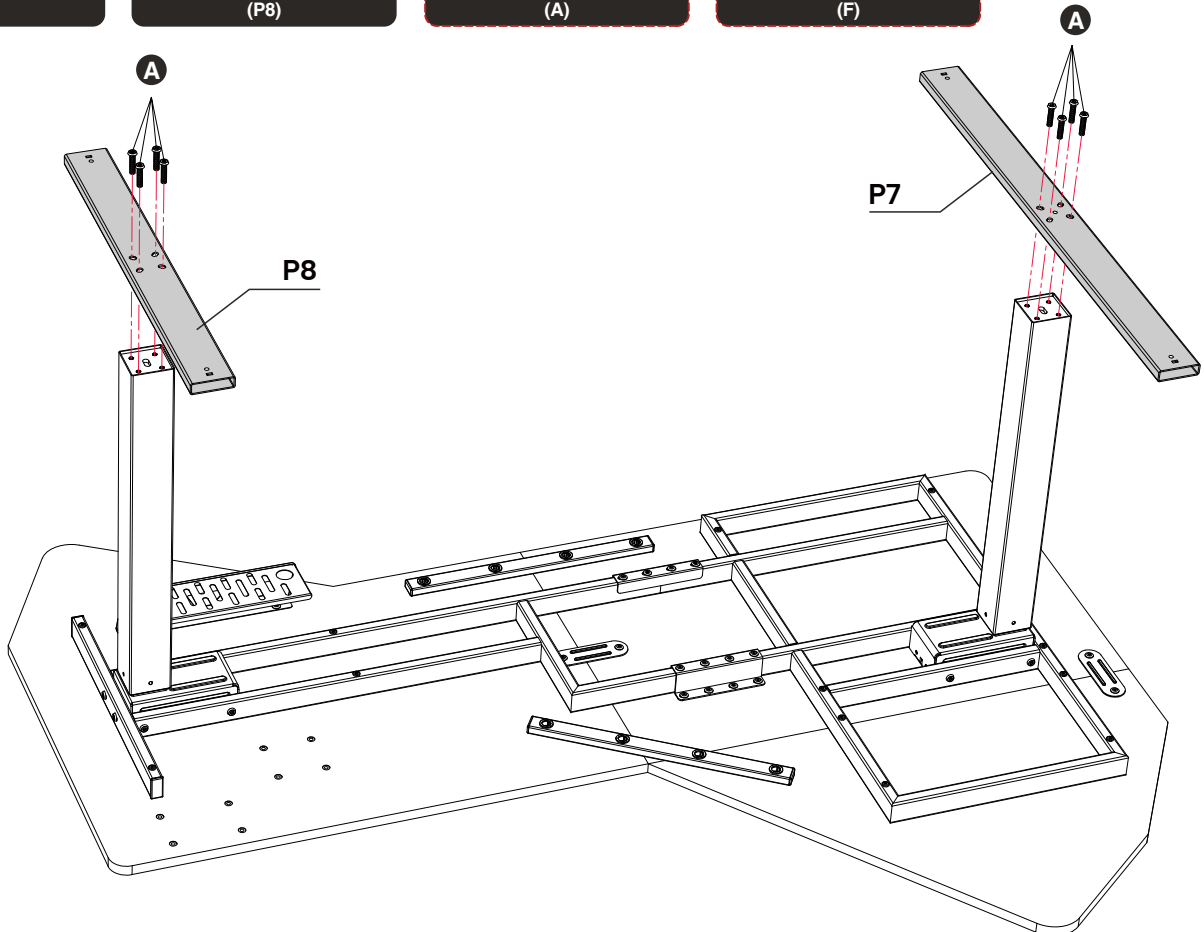
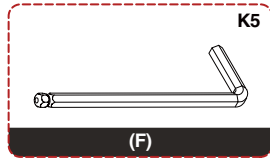
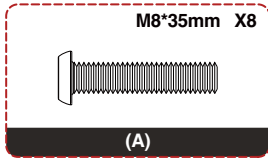
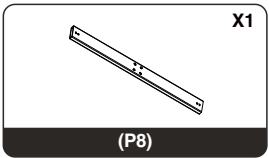
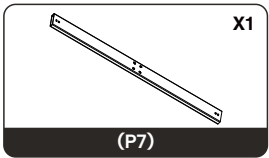

STEP 8

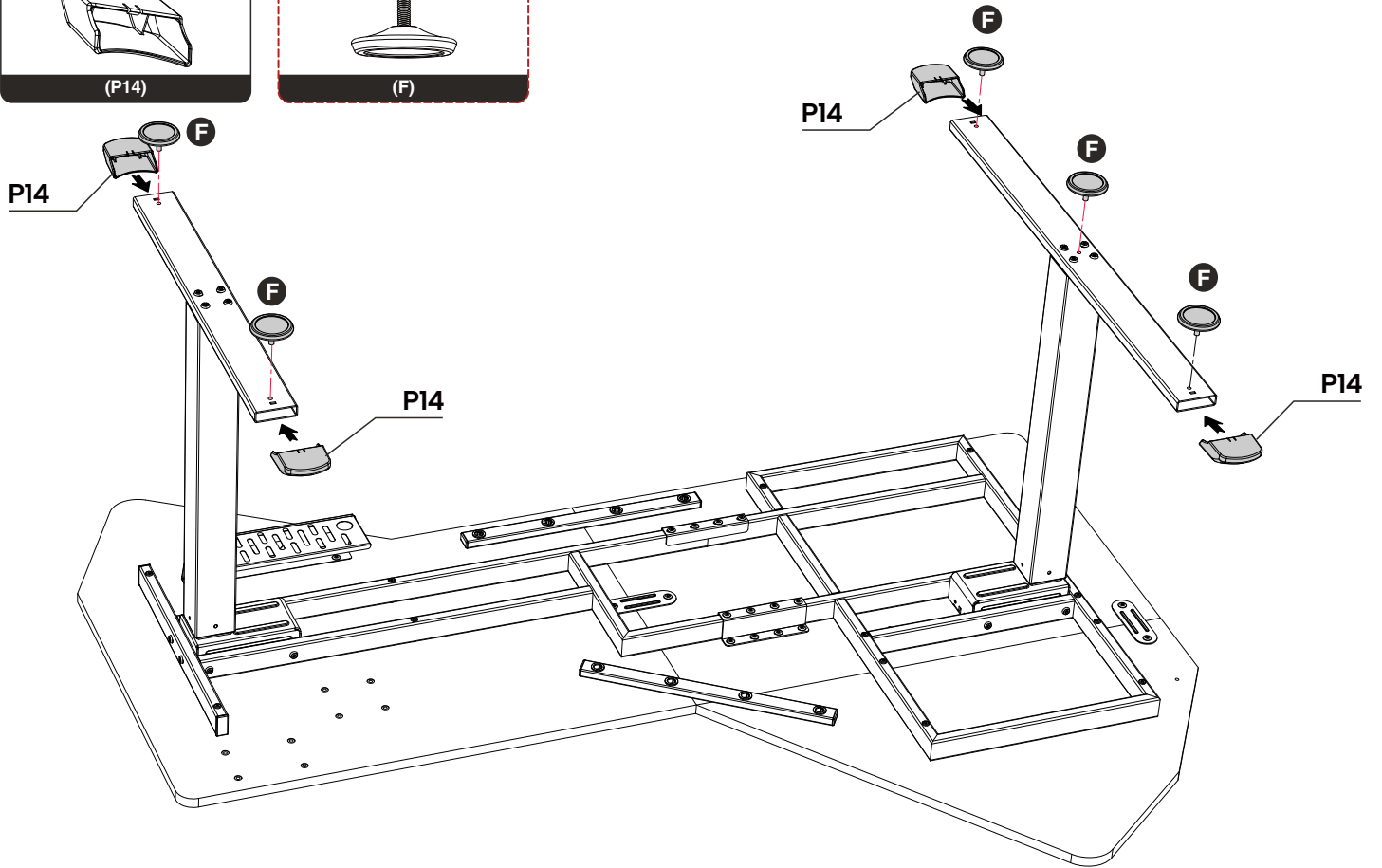
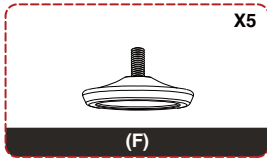
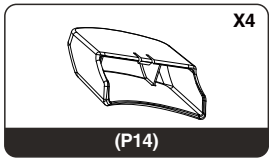

STEP 9

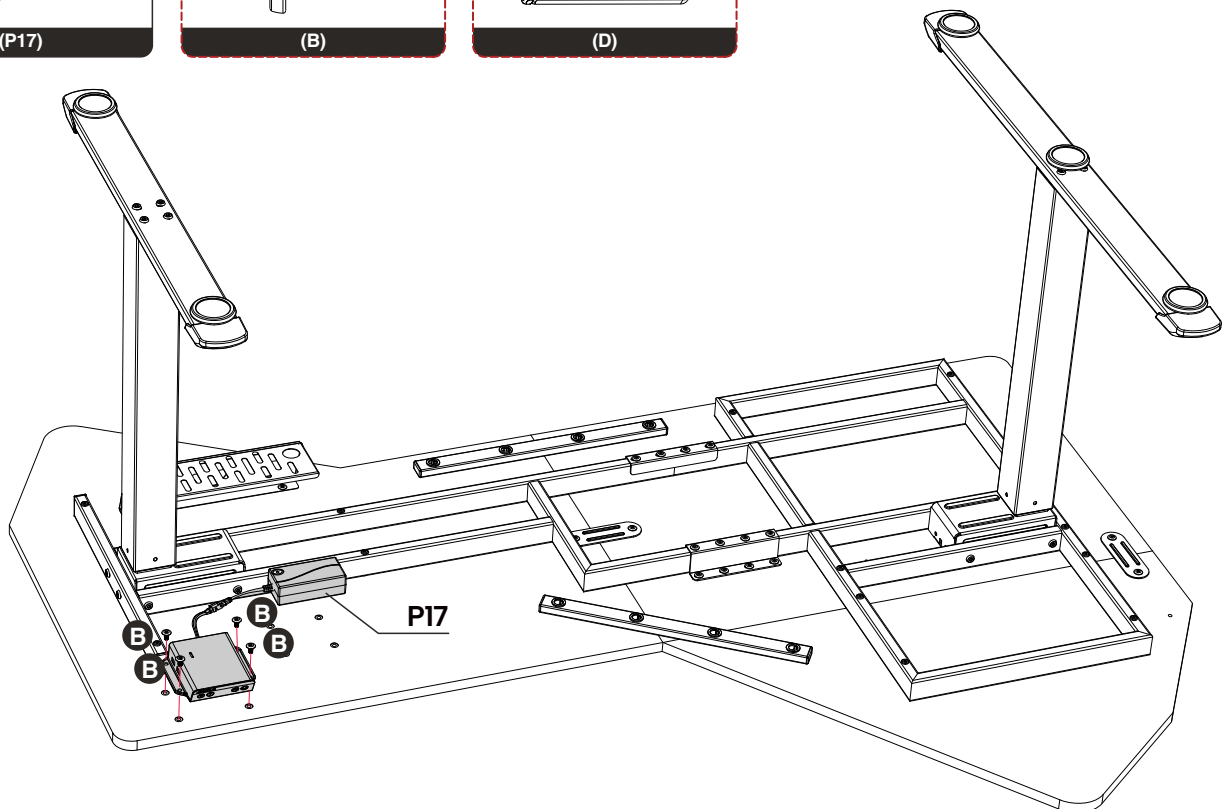
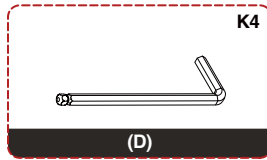
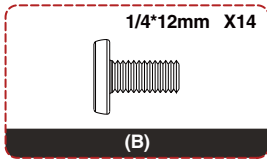
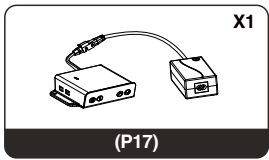

STEP 10

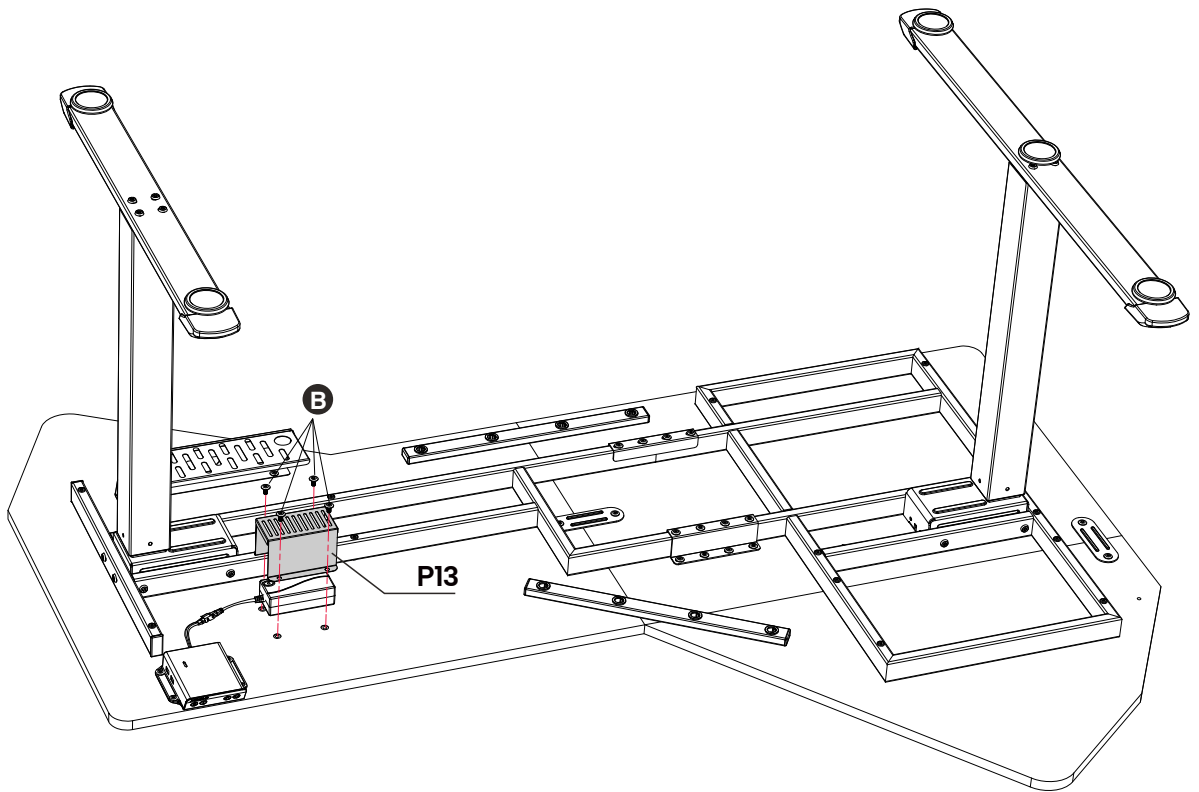
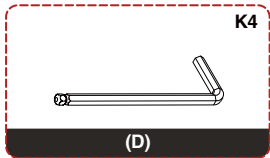
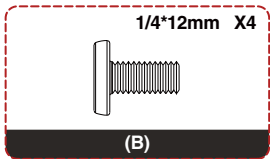
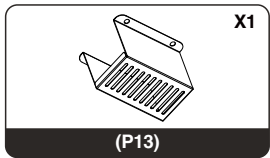

STEP 11

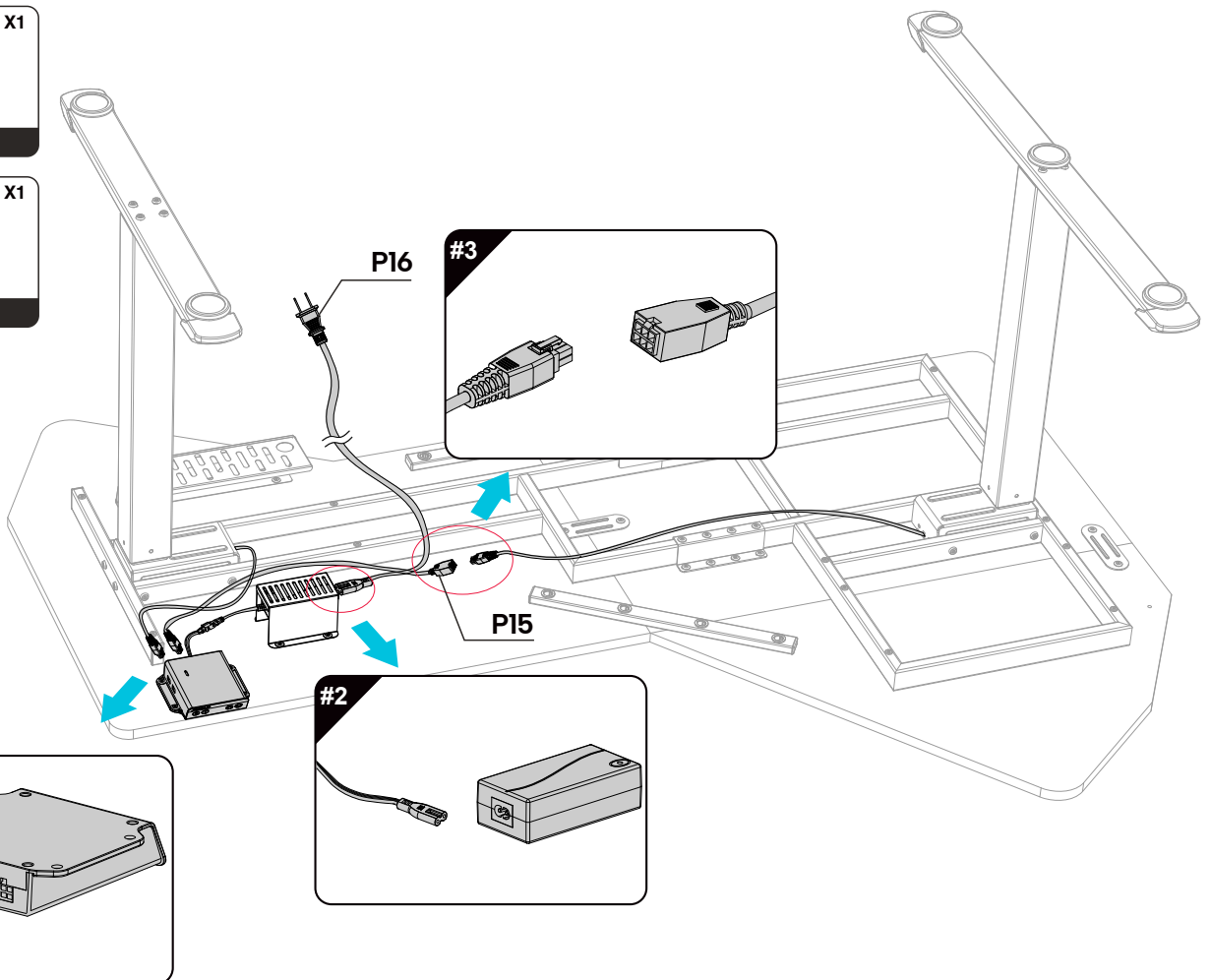
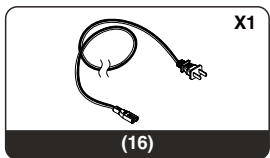
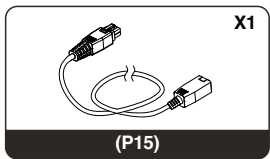

STEP 12

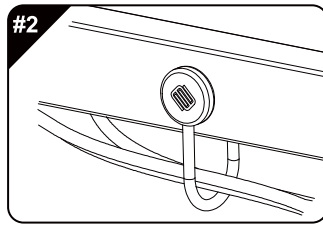
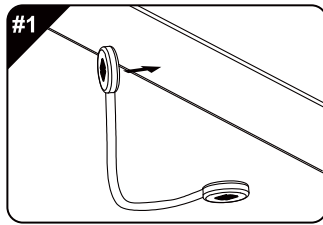
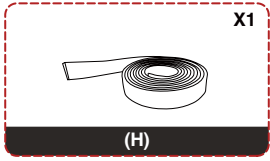
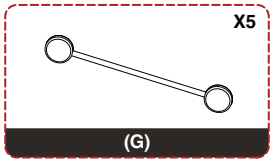

Cut as needed
Coupez selon les besoins
Cortar según sea necesario
根据需要自由裁剪

STEP 13

