

MODEL # **ERK-AED-E70B-V3**

E70 EXPLORED ANCHOR DESK

E70 BUREAU D'ANCRAGE EXPLORÉ

E70 ESCRITORIO DE ANCLAJE EXPLORED

E70 探索版主播桌

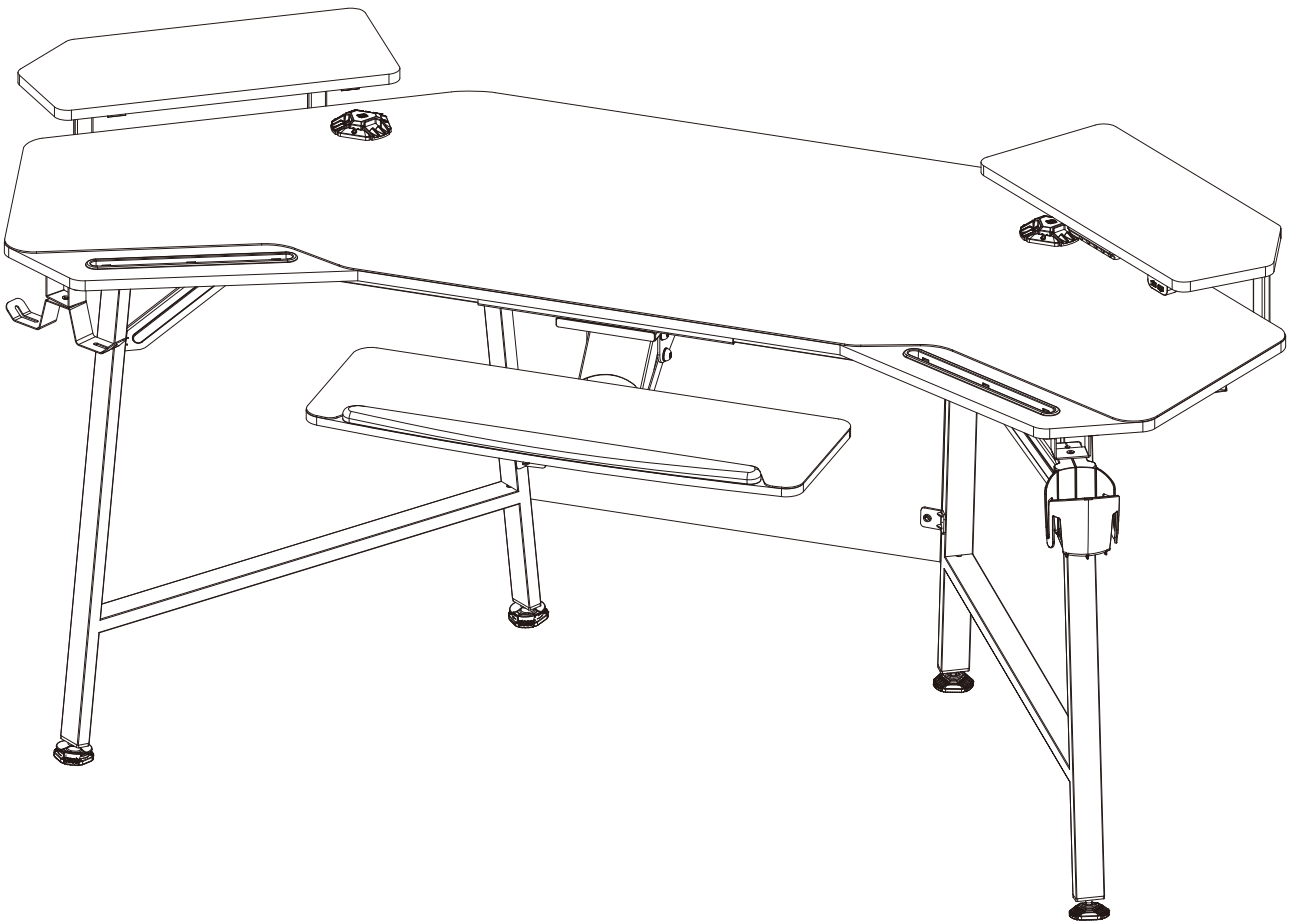

If you need to return the goods, please keep all the packaging materials and return it in the original packaging.
Si vous devez retourner la marchandise, veuillez conserver tous les matériaux d'emballage et le retourner dans l'emballage d'origine.
Si necesita devolver los productos, conserve todos los materiales de embalaje y devuélvalos en el embalaje original.
如需退货请保留好所有包装材料，并按原包装包好退回。

PARTS / PIÈCES / PARTES / 部件清单

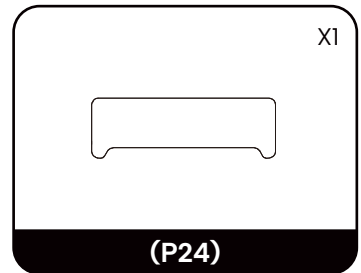
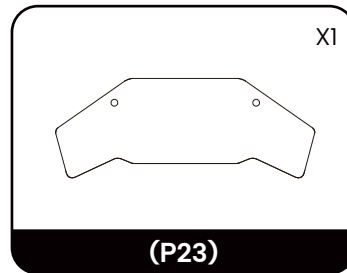
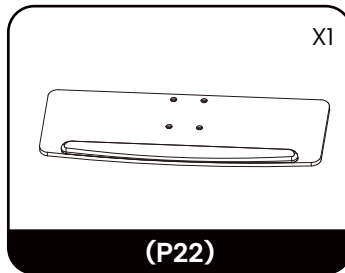
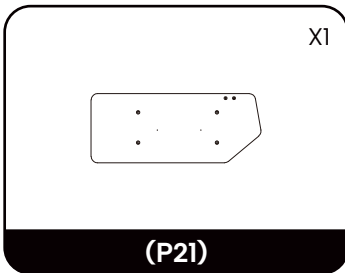
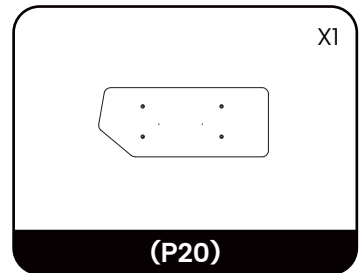
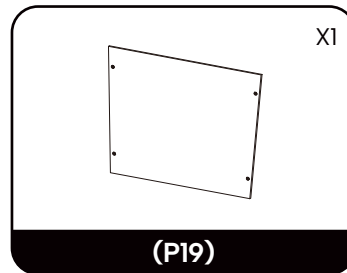
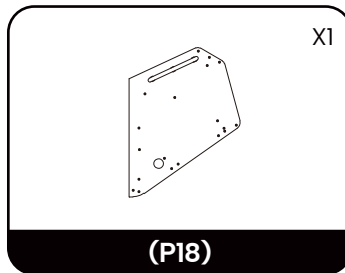
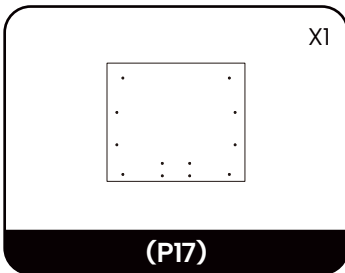
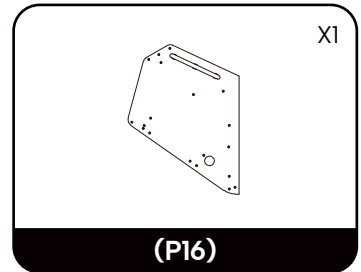
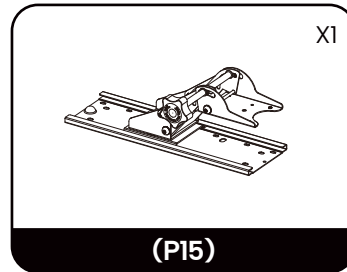
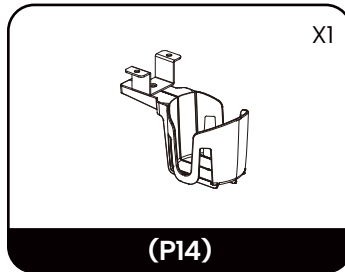
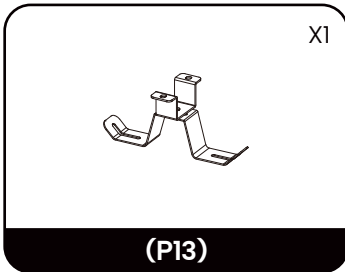
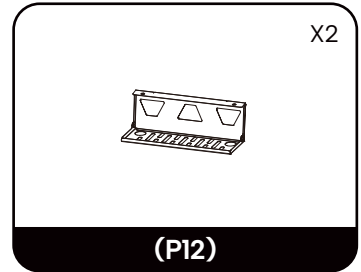
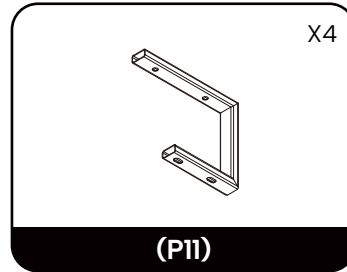
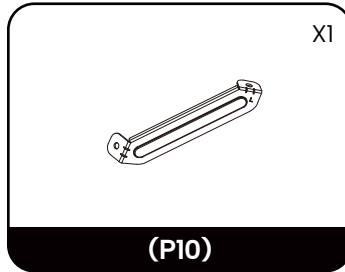
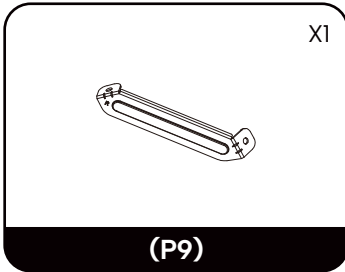
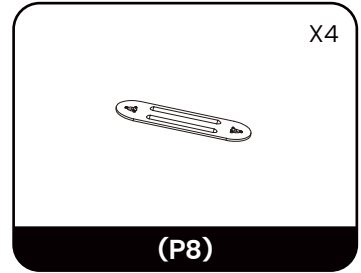
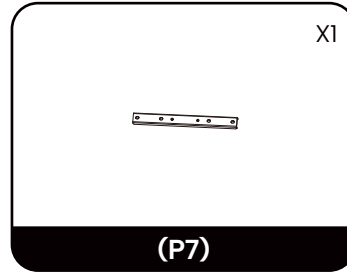
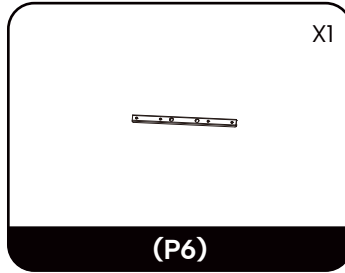
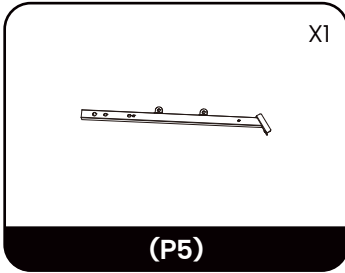
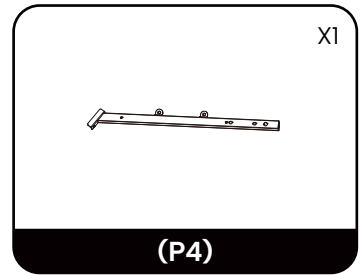
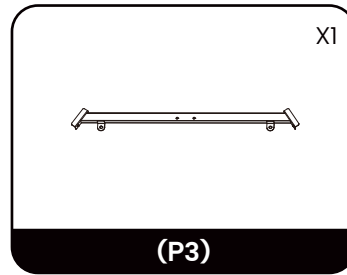
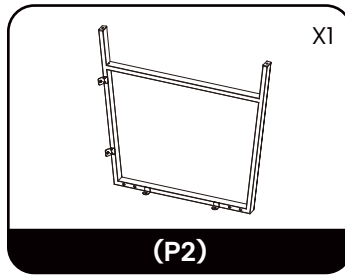
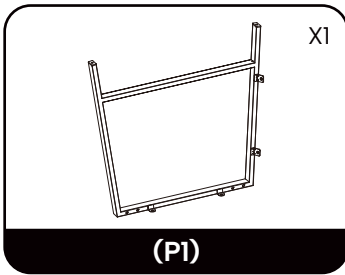

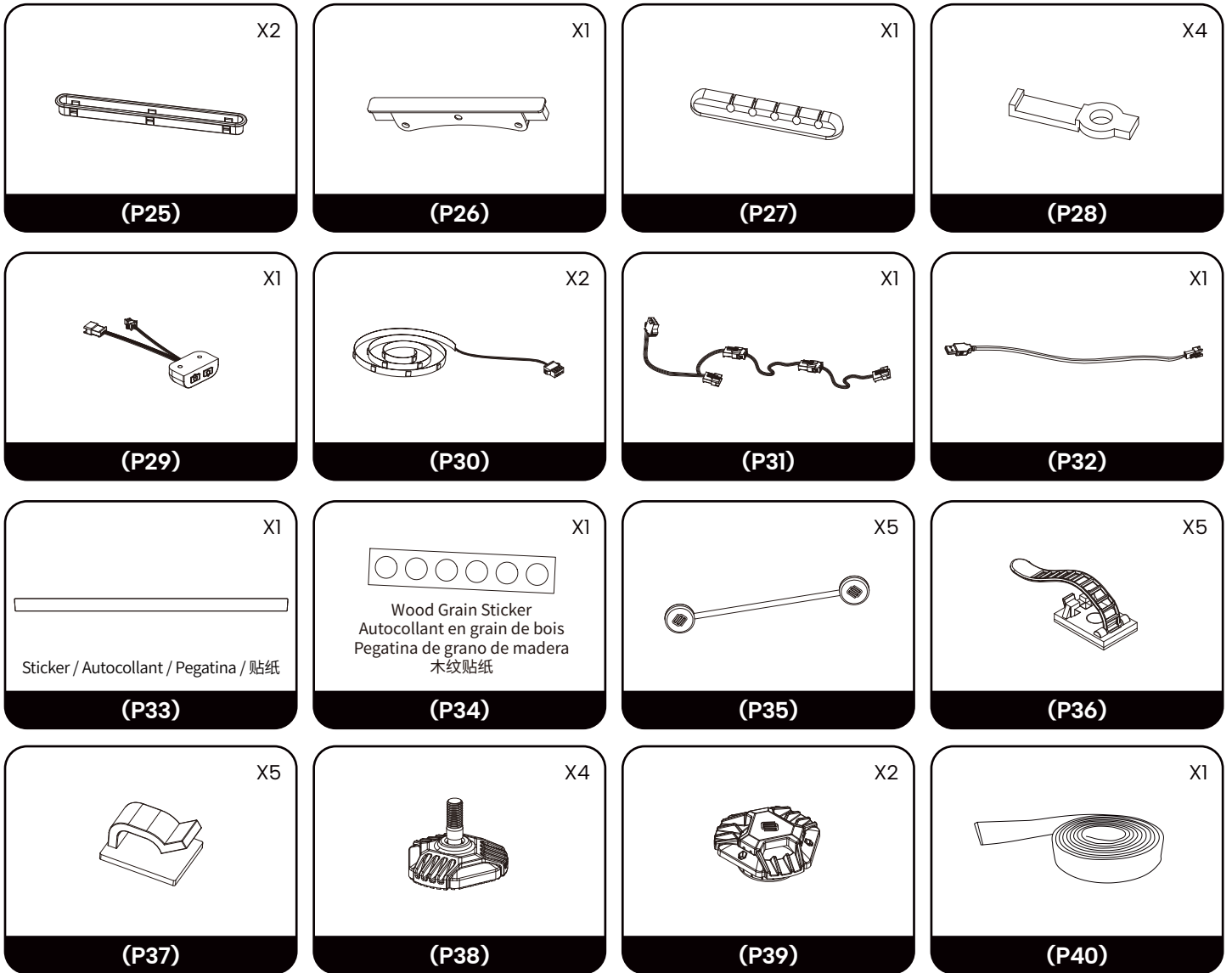

HARDWARE / MATÉRIEL / HARDWARE / 配件清单

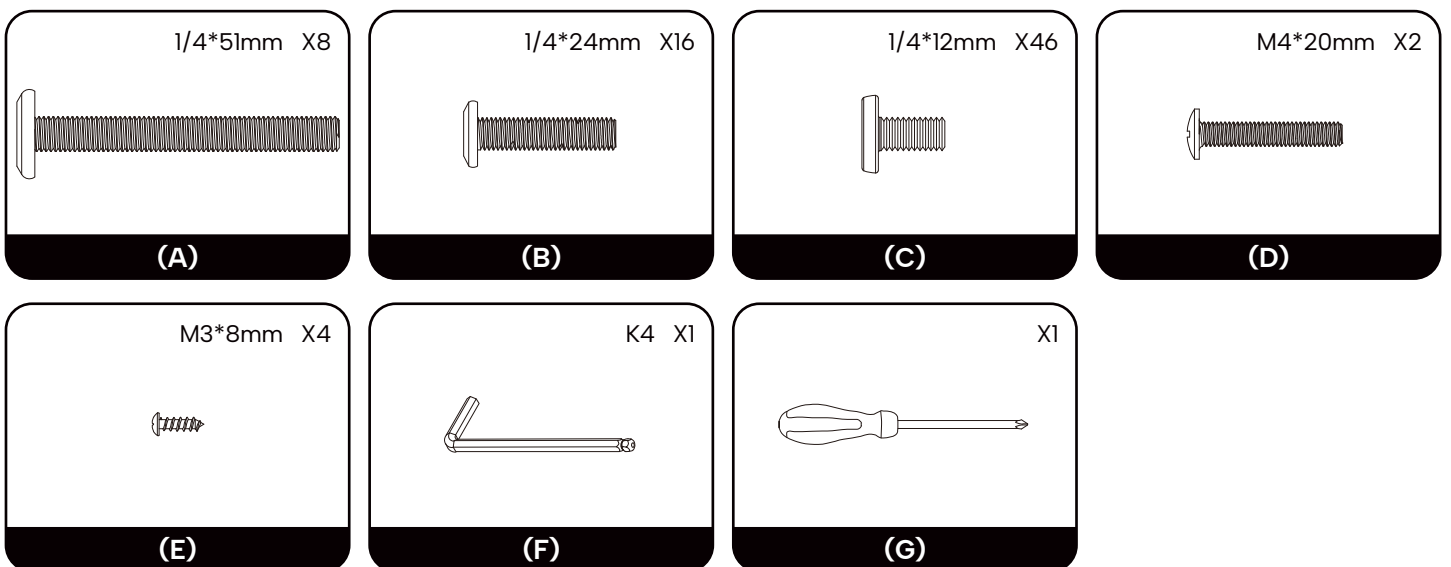



Do not tighten the screws until all of them are fastened into the holes.
 Ne serrez pas les vis tant qu'elles ne sont pas toutes fixées dans les trous.
 No apriete los tornillos hasta que todos estén fijados en los orificios.
 安装时先不要把螺丝拧紧，等所有螺丝都拧到螺纹孔上再将全部螺丝拧紧。

ASSEMBLY INSTRUCTIONS

INSTRUCTIONS DE MONTAGE

INSTRUCCIONES DE MONTAJE

安装说明

STEP 1

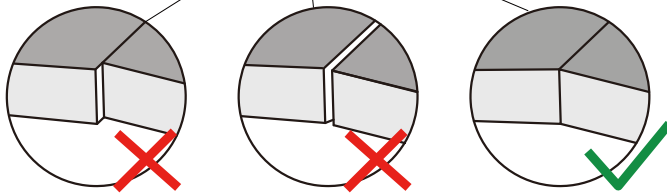
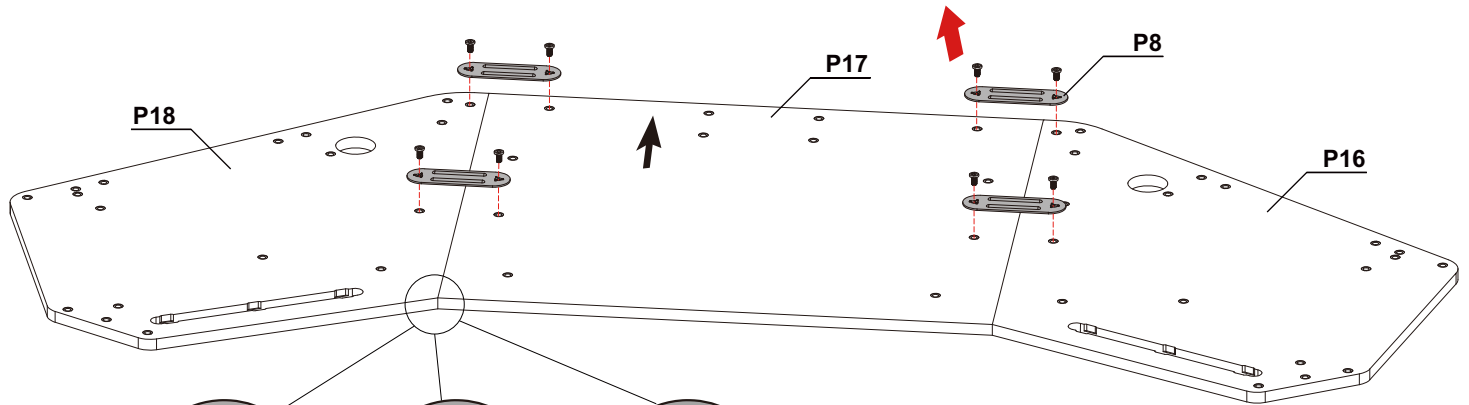
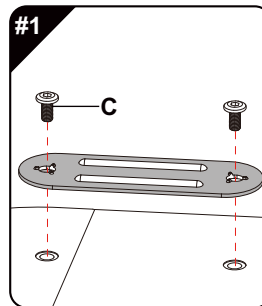
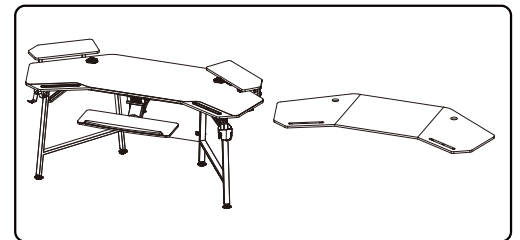
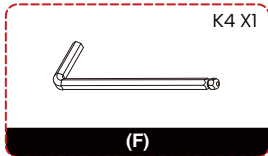
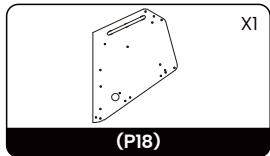
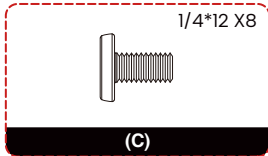
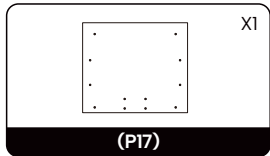
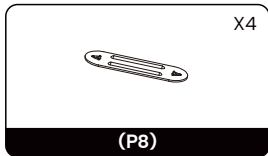
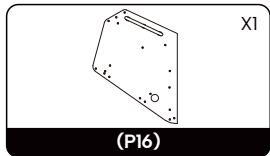

Before tightening the screws, make sure that the two desktop pieces are aligned.
 Avant de serrer les vis, assurez-vous que les deux parties du bureau sont alignées.
 Antes de apretar los tornillos, asegúrese de que las dos piezas del escritorio están alineadas.
 拧紧螺丝之前，确保两块桌板之间相互对齐。

STEP 2

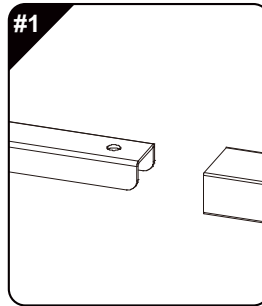
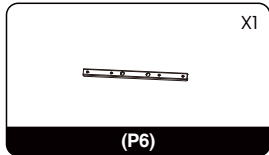
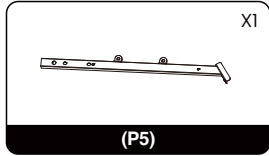
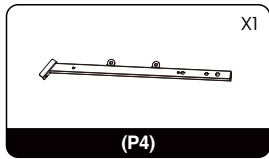

The U-channels face down.
Les canaux en U sont orientés vers le bas.
Los canales en U están orientados hacia abajo.
U型槽面朝下。

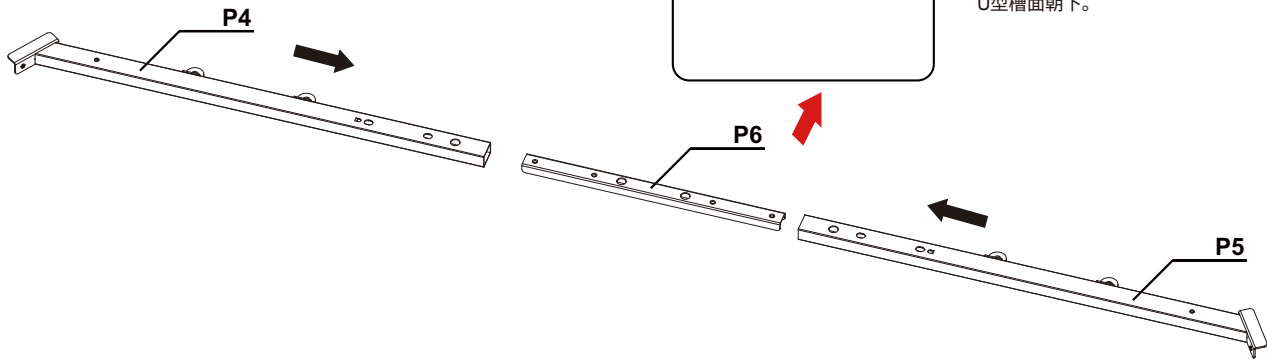

STEP 3

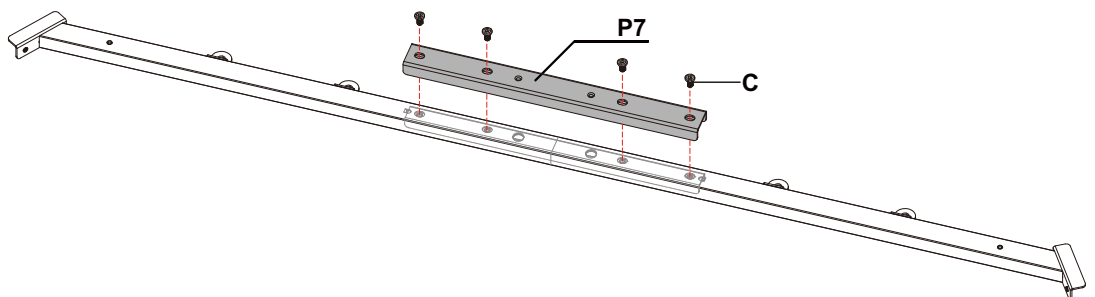
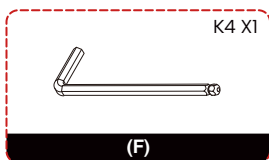
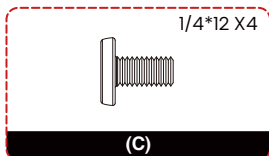
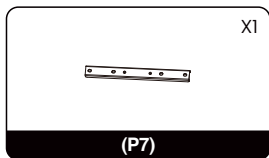

STEP 4

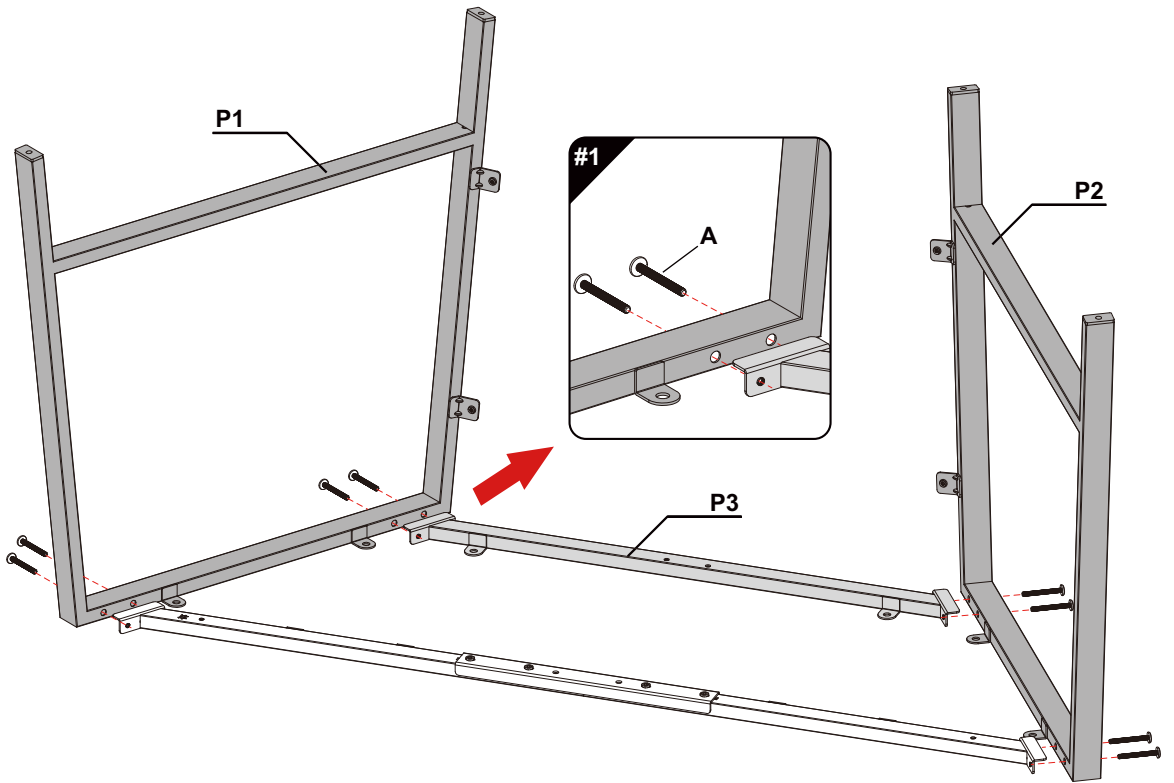
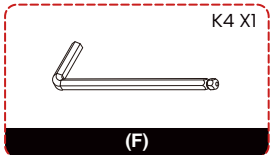
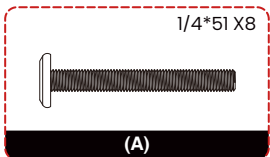
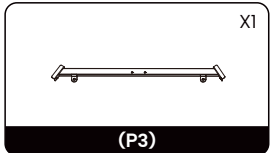
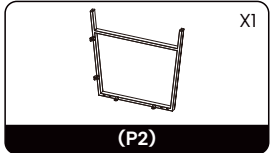
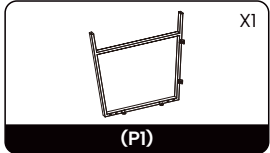

STEP 5

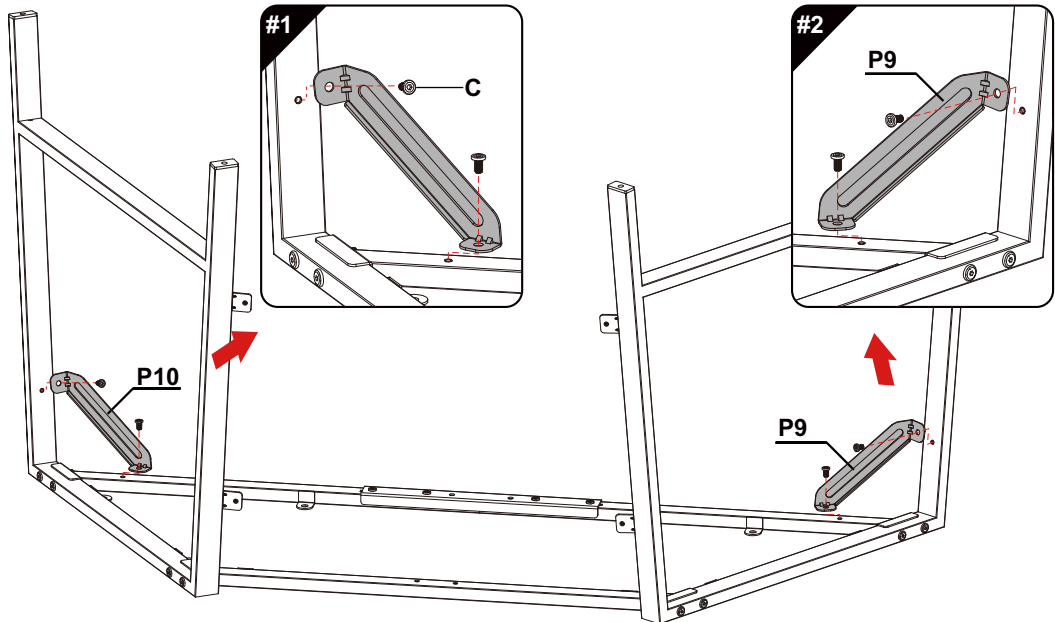
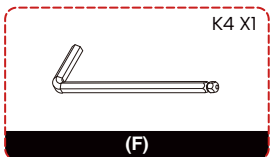
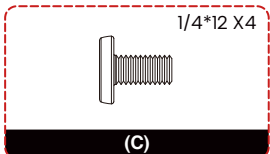
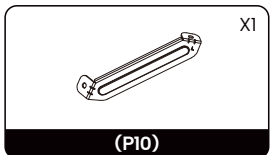
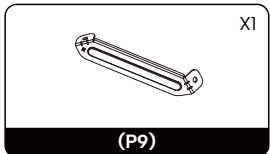

STEP 6

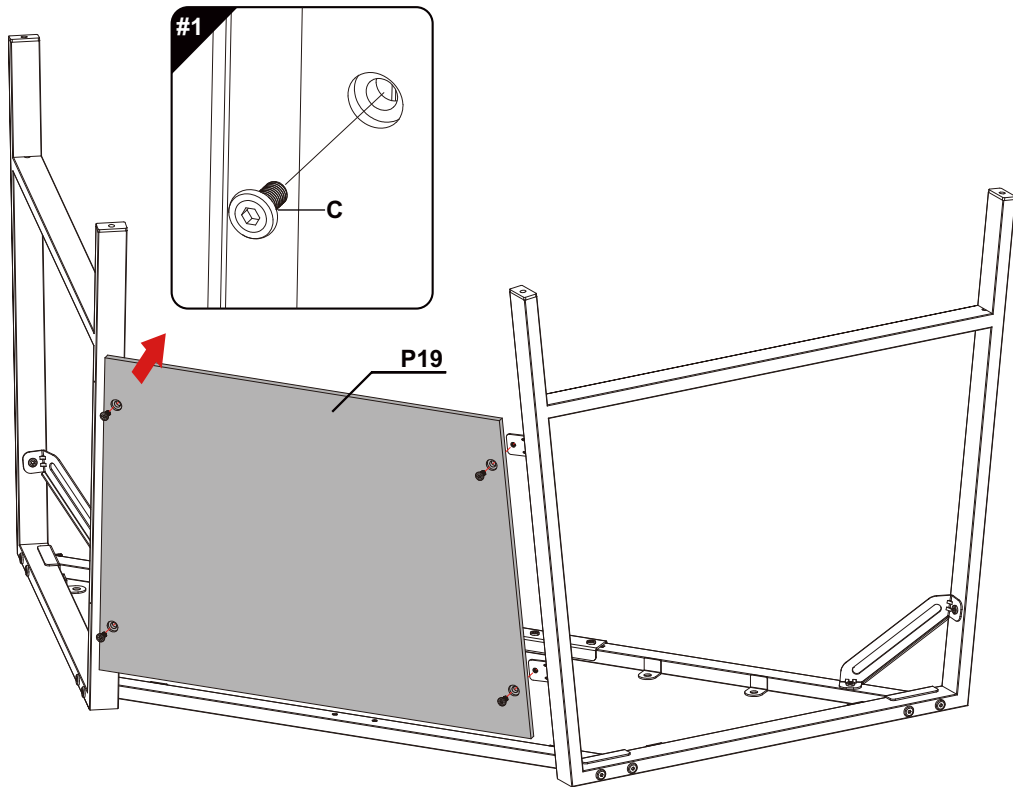
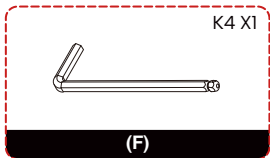
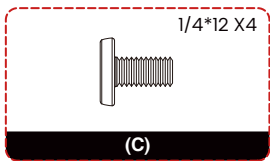
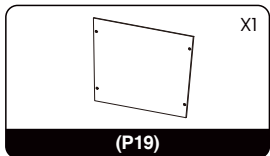

STEP 7

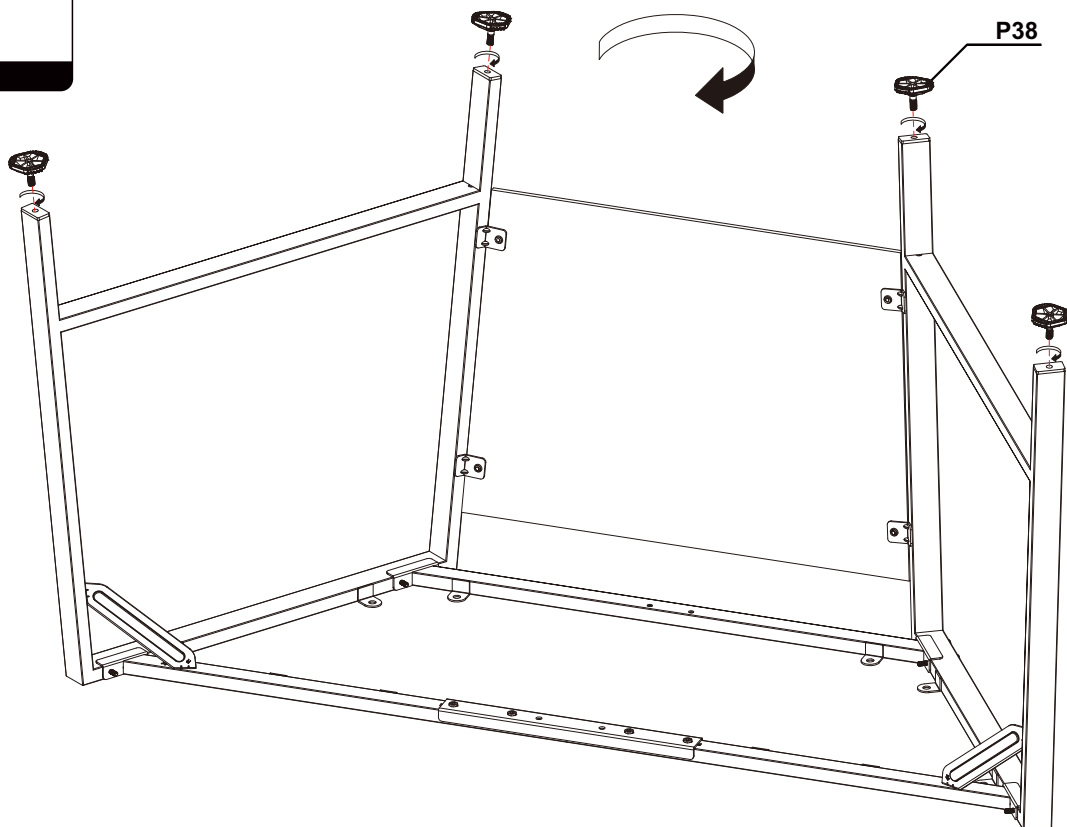
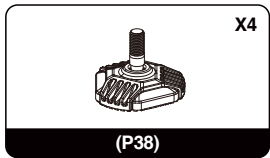

STEP 8

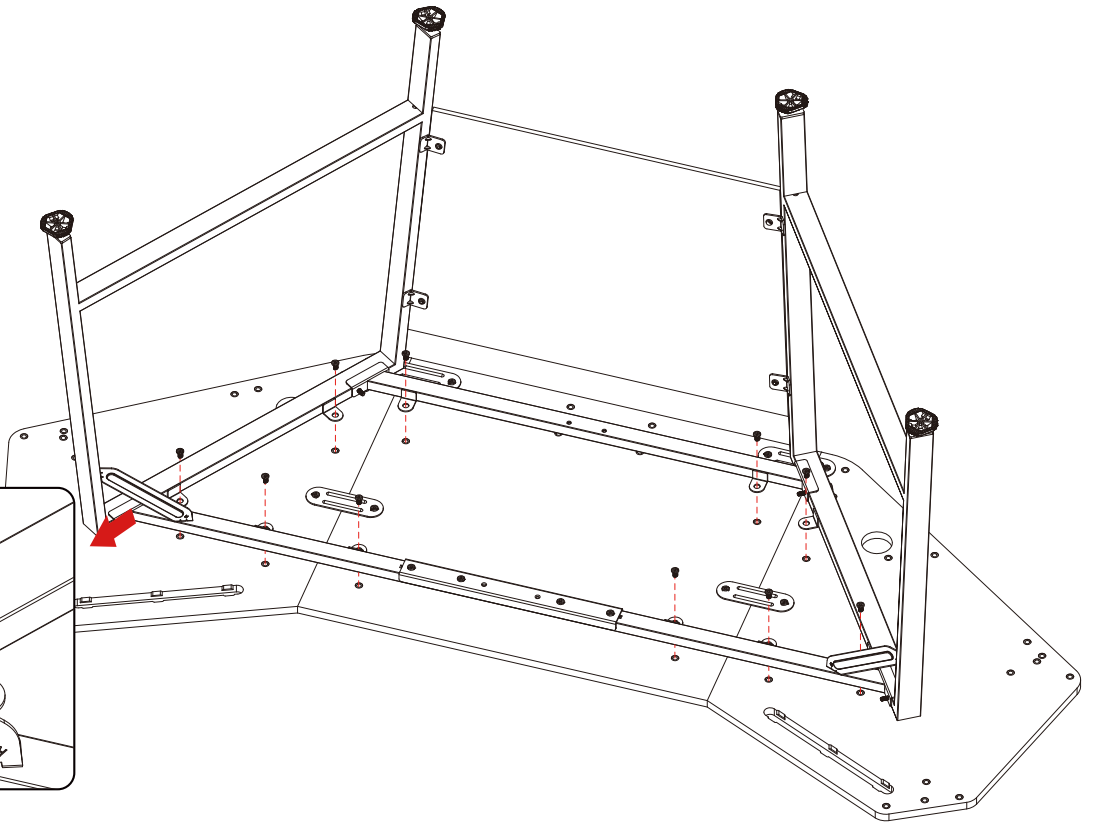
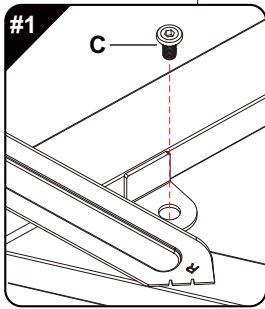
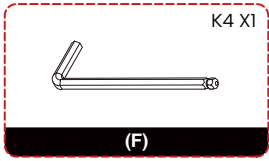
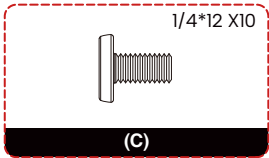

STEP 9

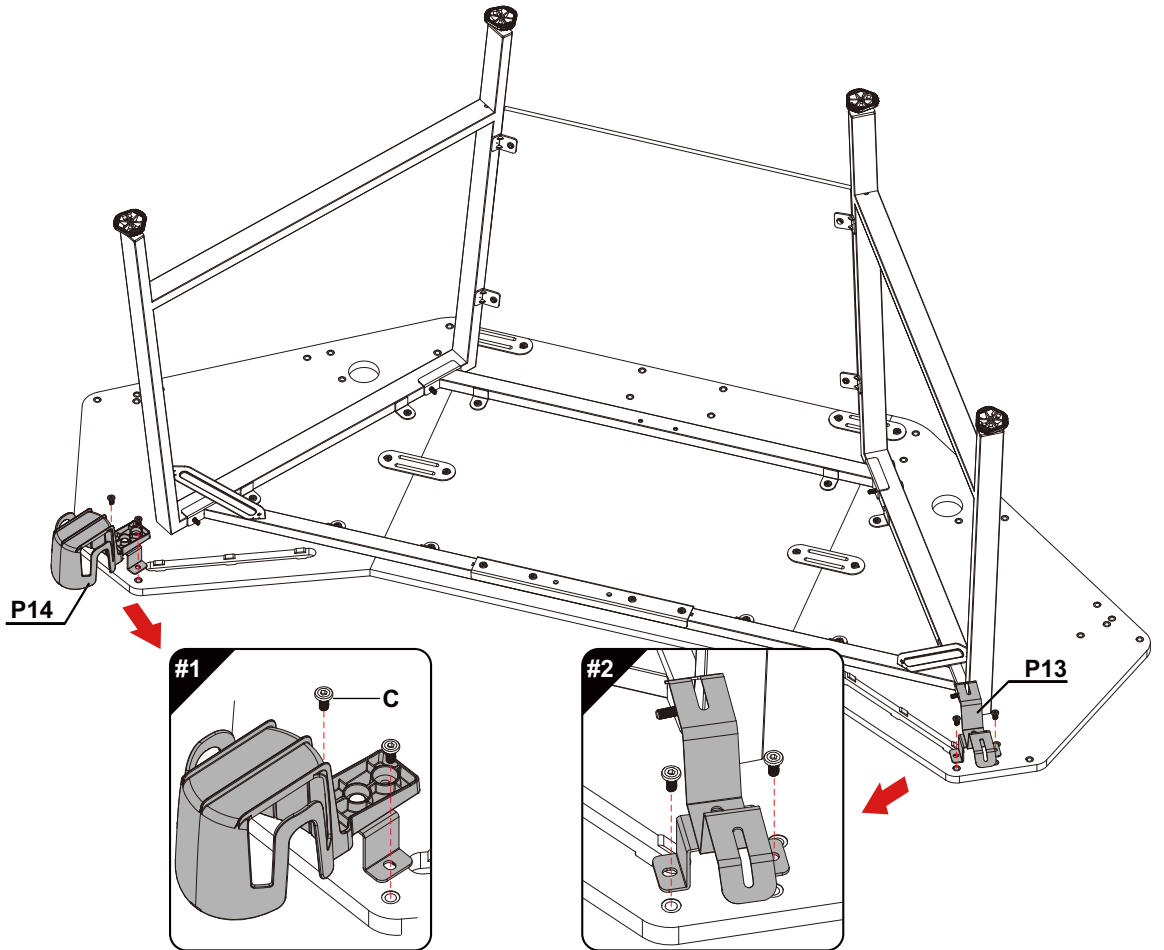
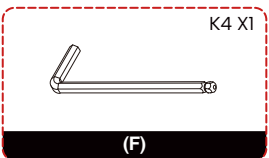
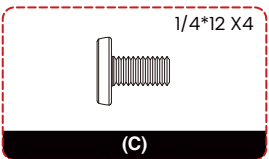
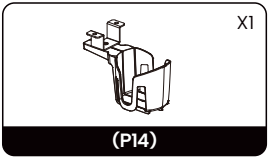
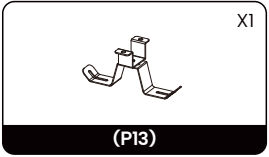

STEP 10

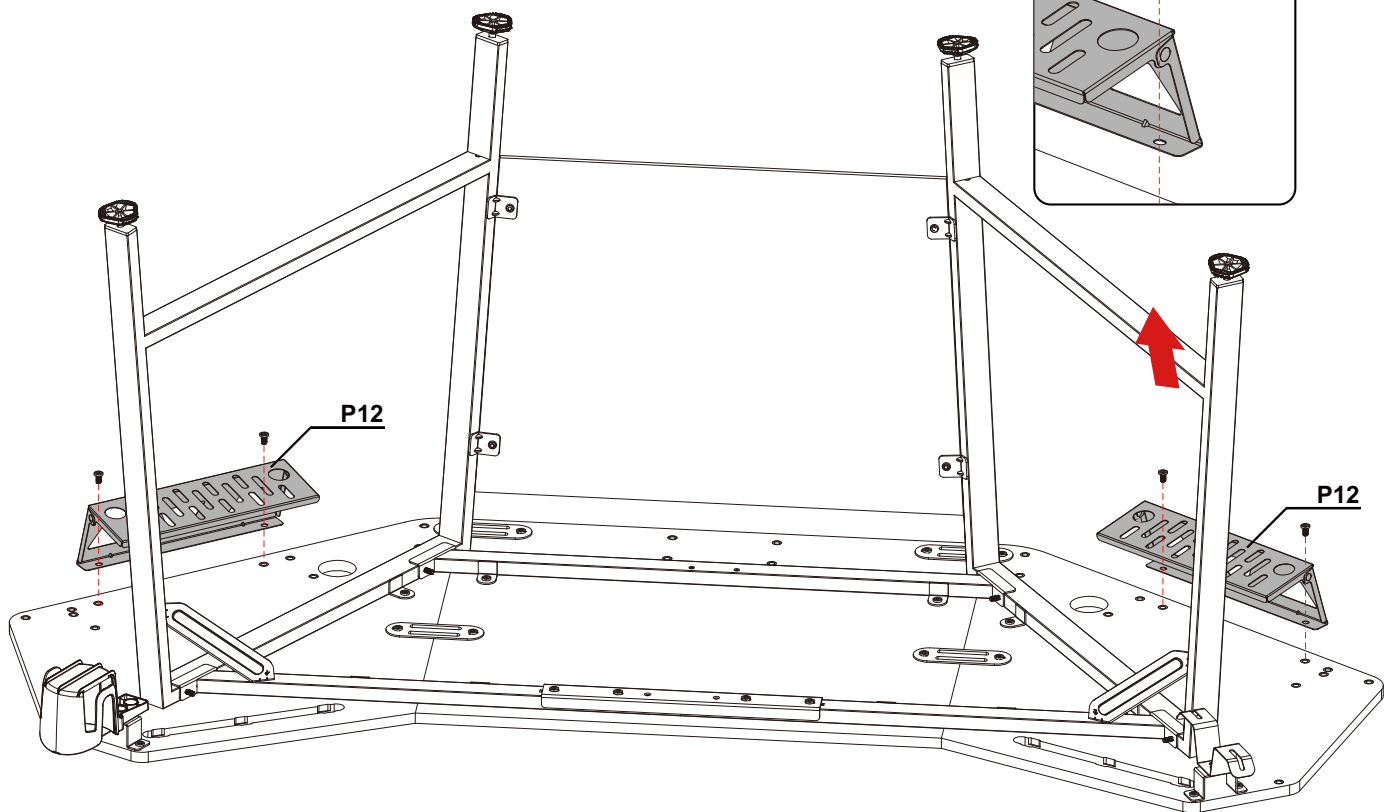
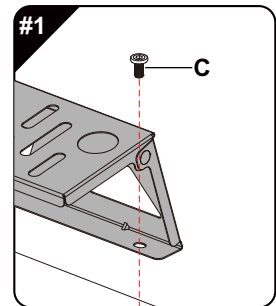
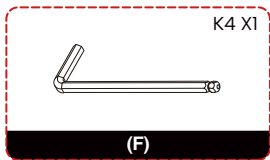
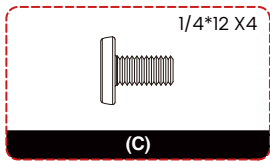
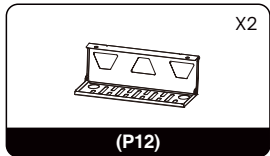

STEP 11

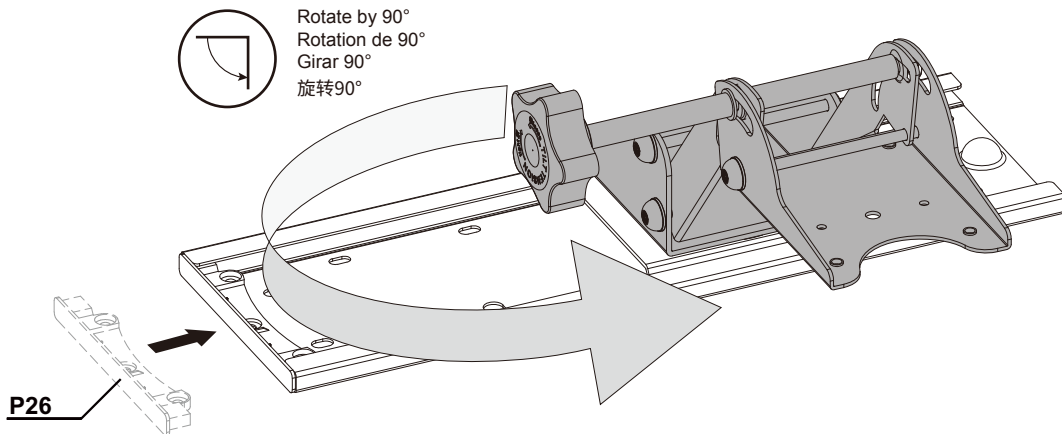
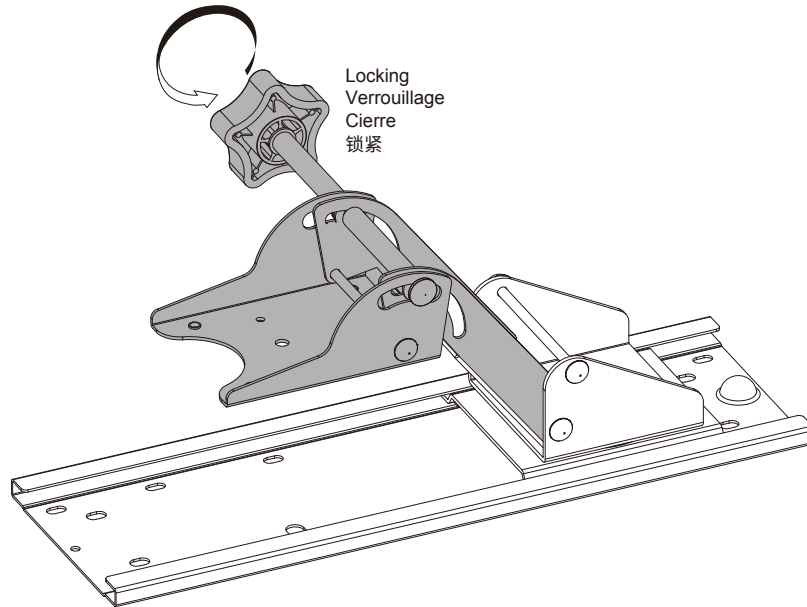
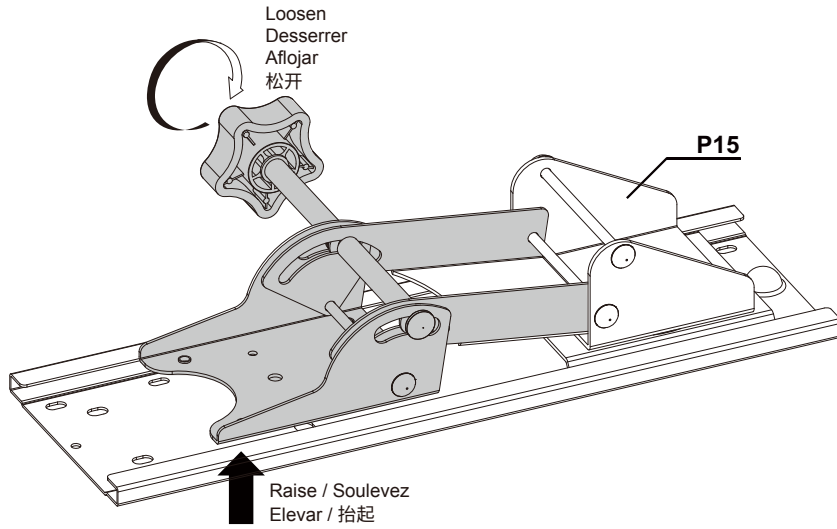
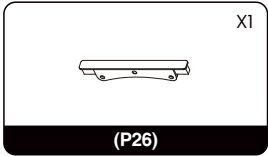
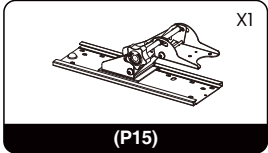

STEP 12

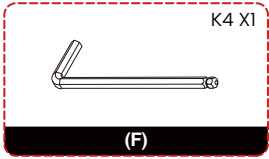
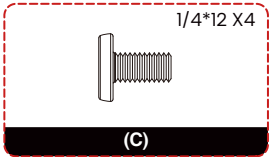

Please cut this cable tie
Veuillez couper ce serre-câble
Por favor, corta esta atadura de cables.
请剪掉扎带

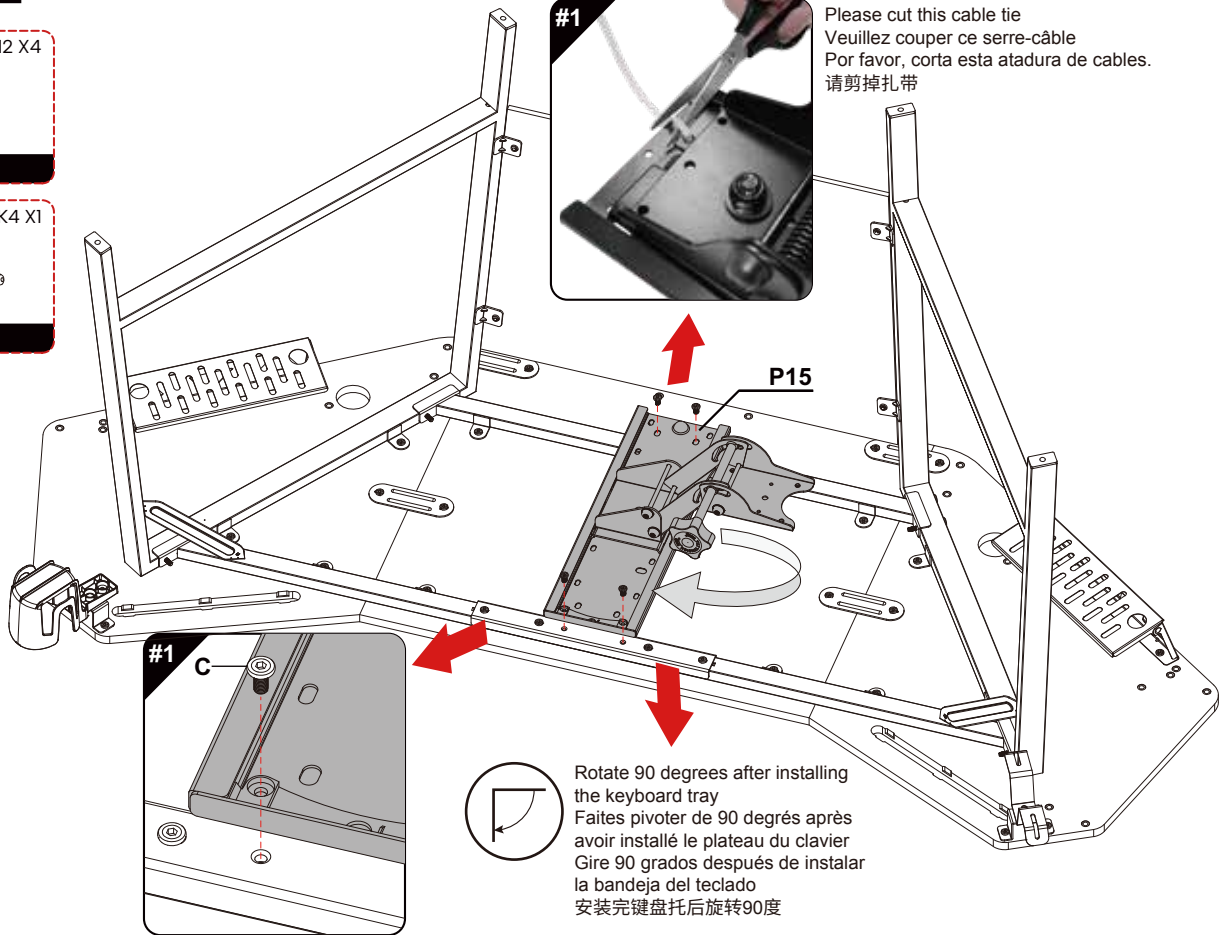

STEP 13

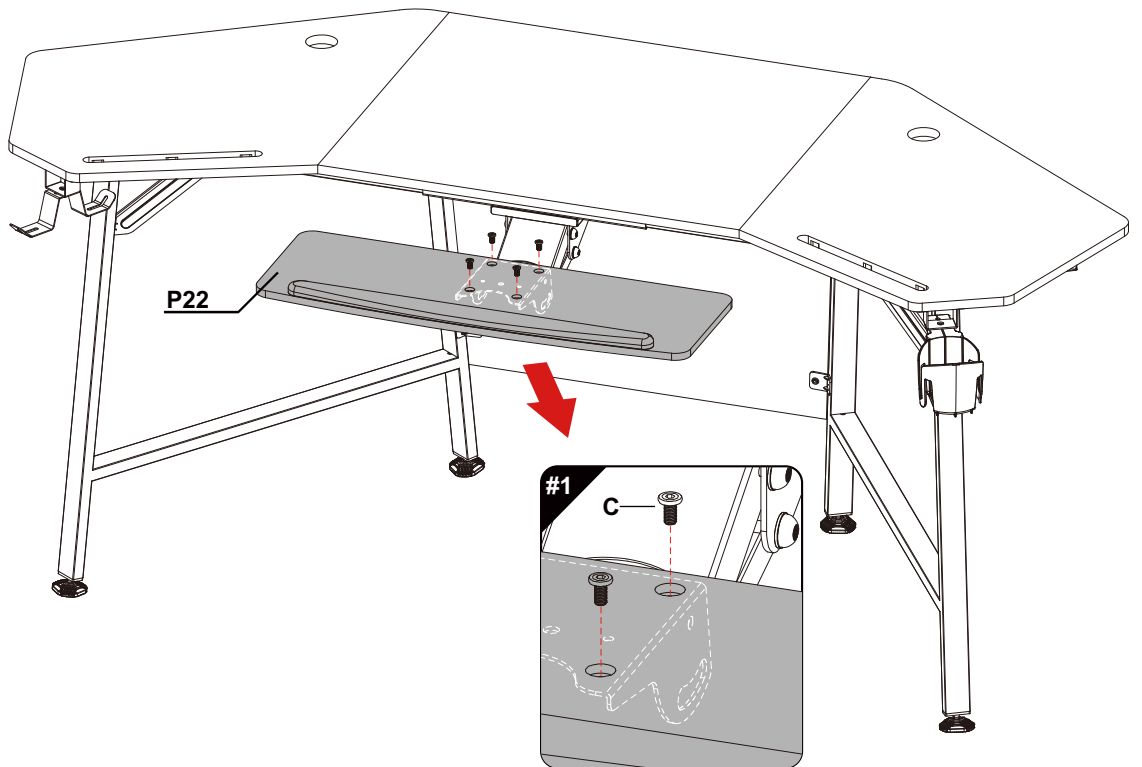
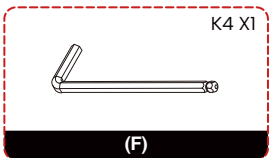
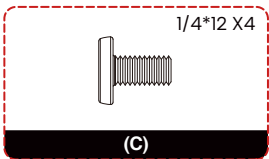
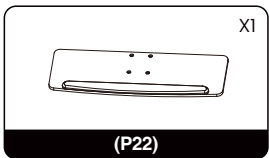

STEP 14

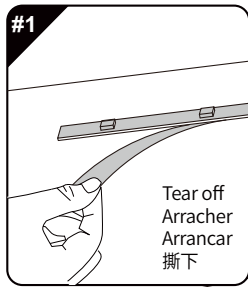
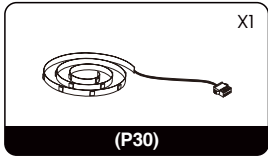
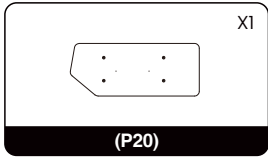

Do not cover the round holes when sticking it.
Ne recouvrez pas les trous ronds lorsque vous le collez.
No cubra los agujeros redondos cuando lo pegue.
粘贴时请勿遮盖圆孔。

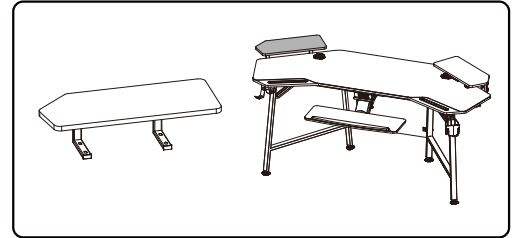
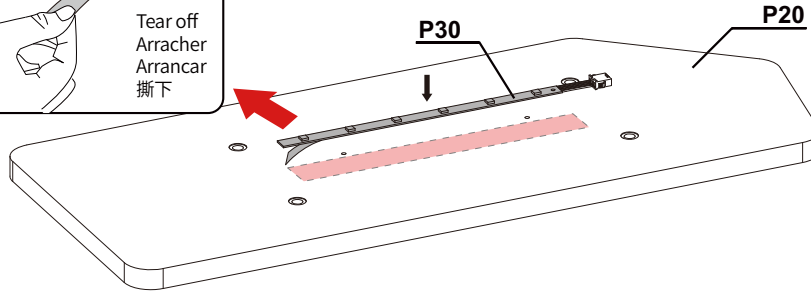

STEP 15

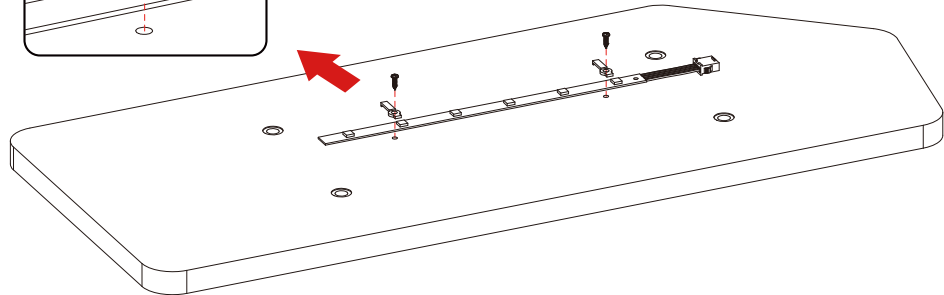
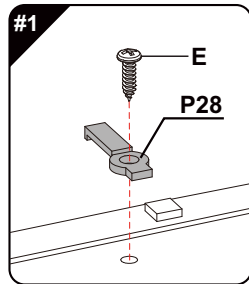
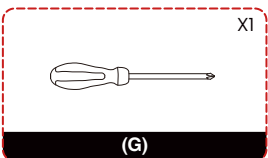
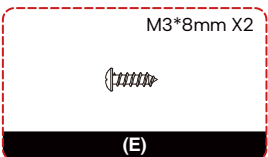
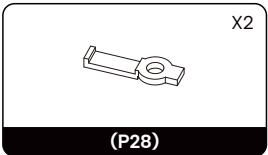

STEP 16

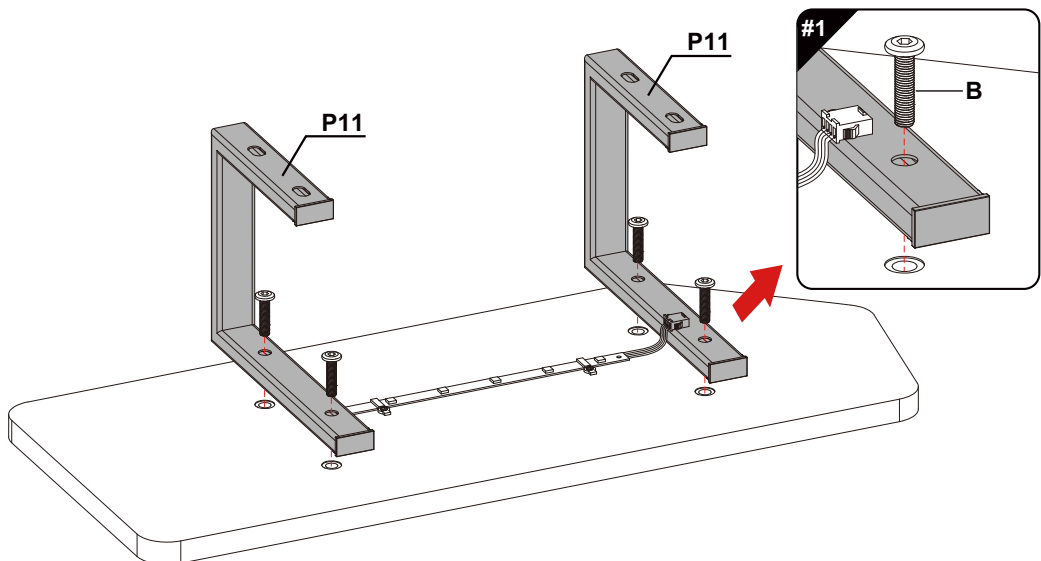
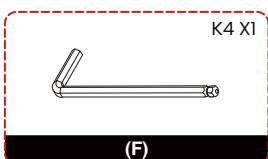
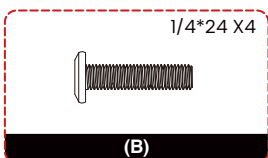
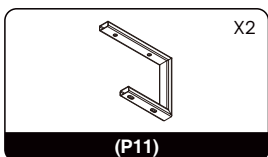

STEP 17

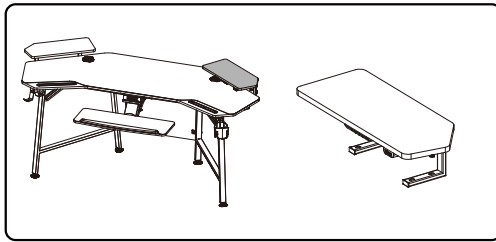
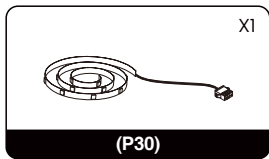
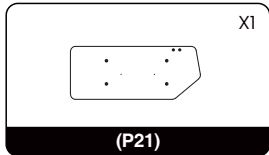

Do not cover the round holes when sticking it.
 Ne recouvrez pas les trous ronds lorsque vous le collez.
 No cubra los agujeros redondos cuando lo pegue.
 粘贴时请勿遮盖圆孔。

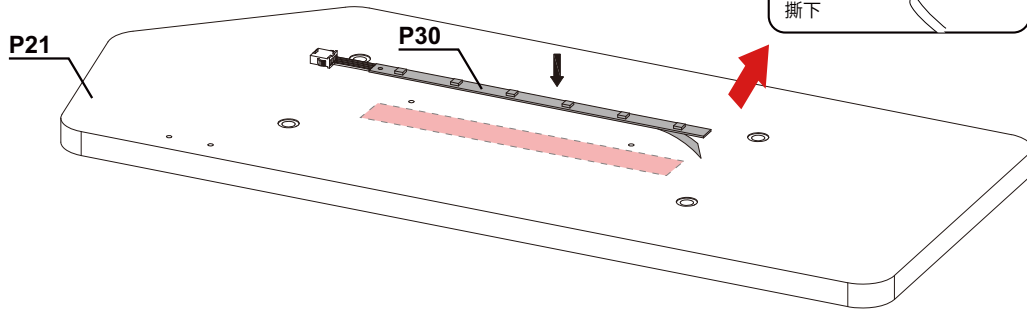
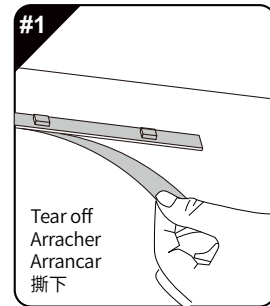

STEP 18

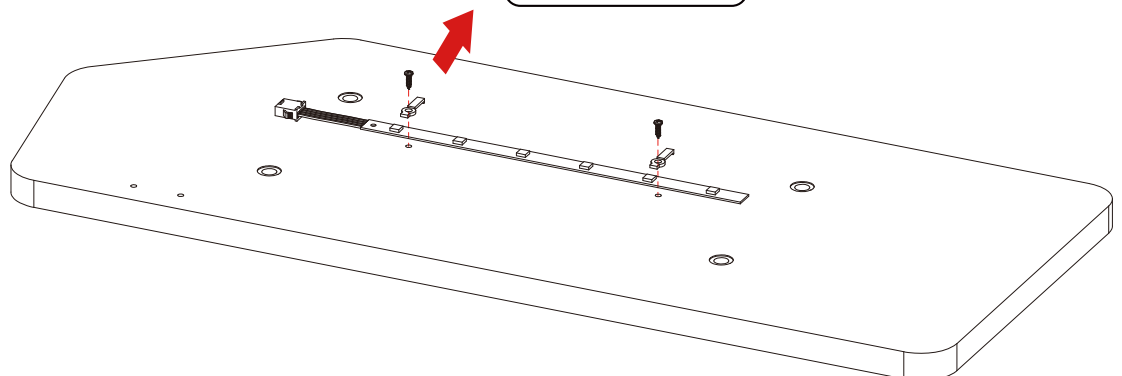
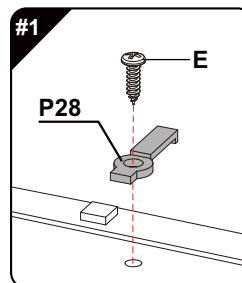
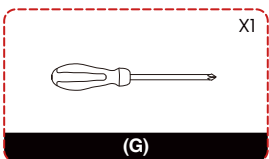
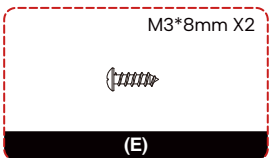
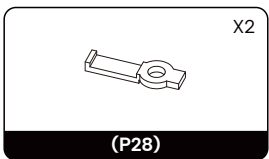

STEP 19

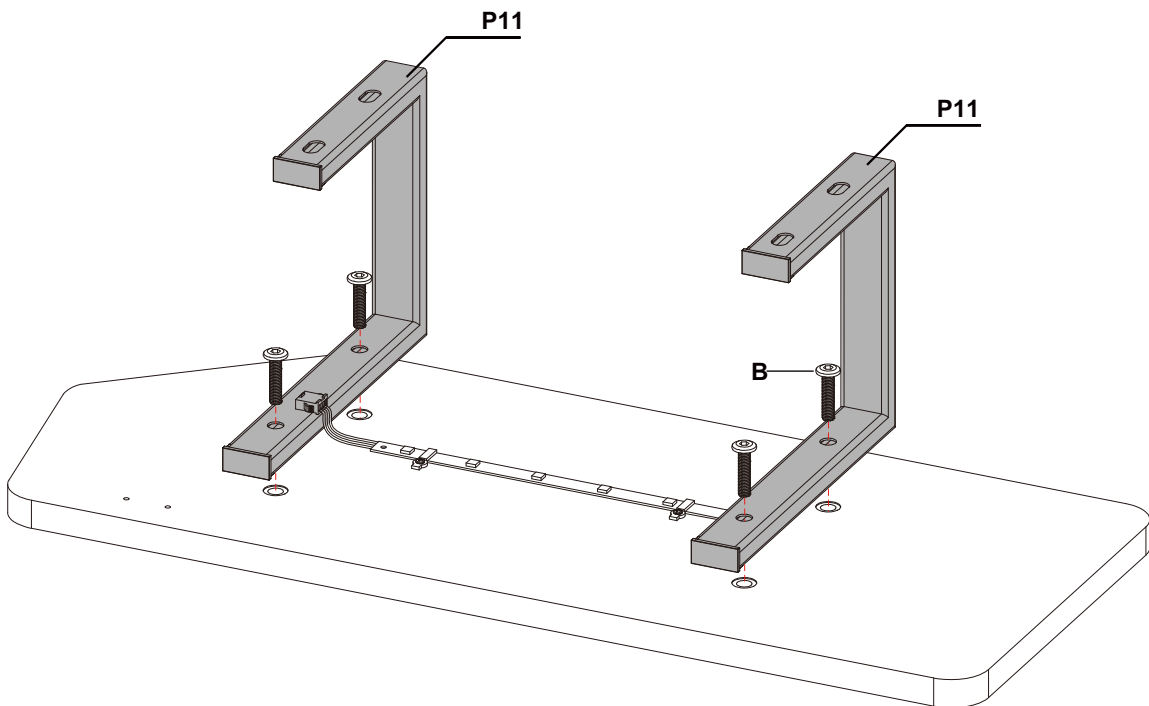
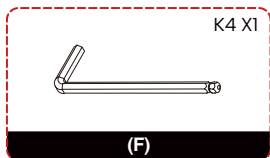
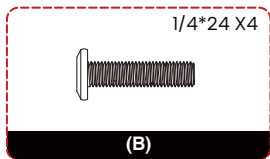
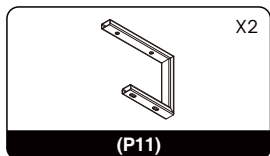

STEP 20

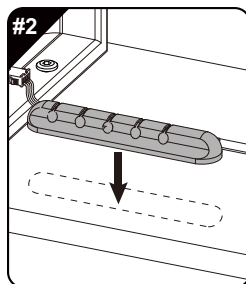
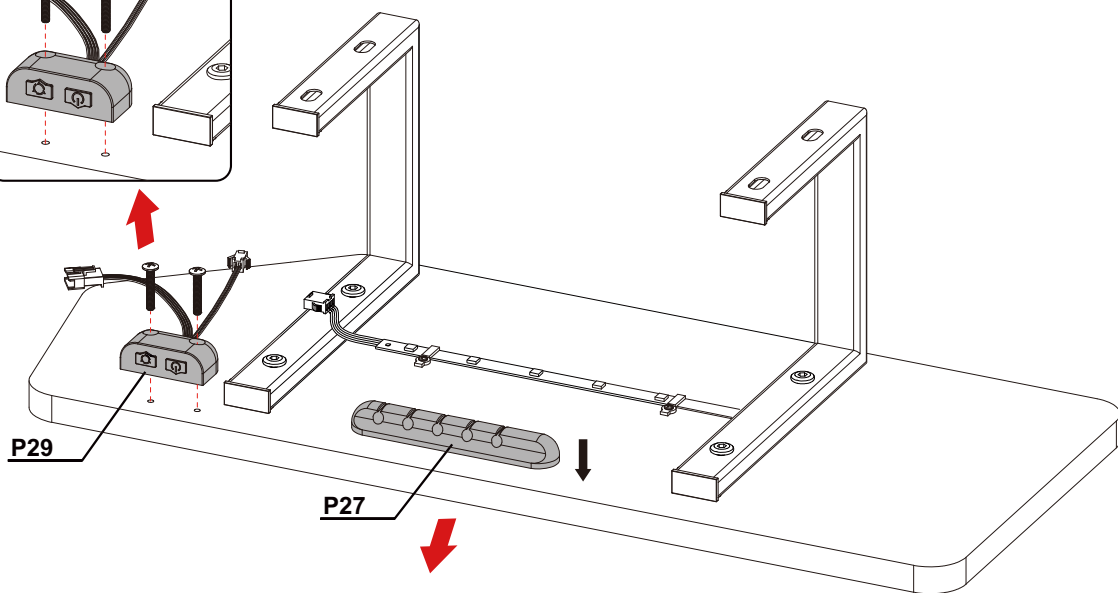
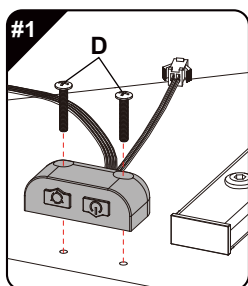
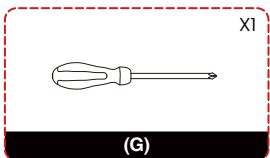
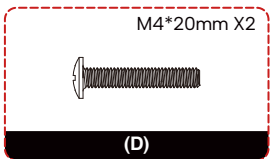
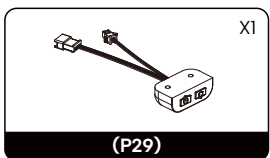
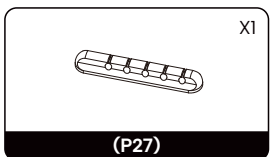

Select the sticking location according to the actual usage habits.
Sélectionnez l'emplacement de collage en fonction des habitudes d'utilisation réelles.
Seleccione el lugar de pegado en función de los hábitos de uso reales.
可根据实际使用习惯选择粘帖位置。

STEP 21

LEFT/RIGHT SHELF INSTALLATION PLAN I

PLAN D'INSTALLATION DE L'ÉTAGÈRE GAUCHE/DROITE I

SOLUCIÓN DE INSTALACIÓN DE LA ESTANTERÍA IZQUIERDA/DERECHA I

左/右小层板安装方案一

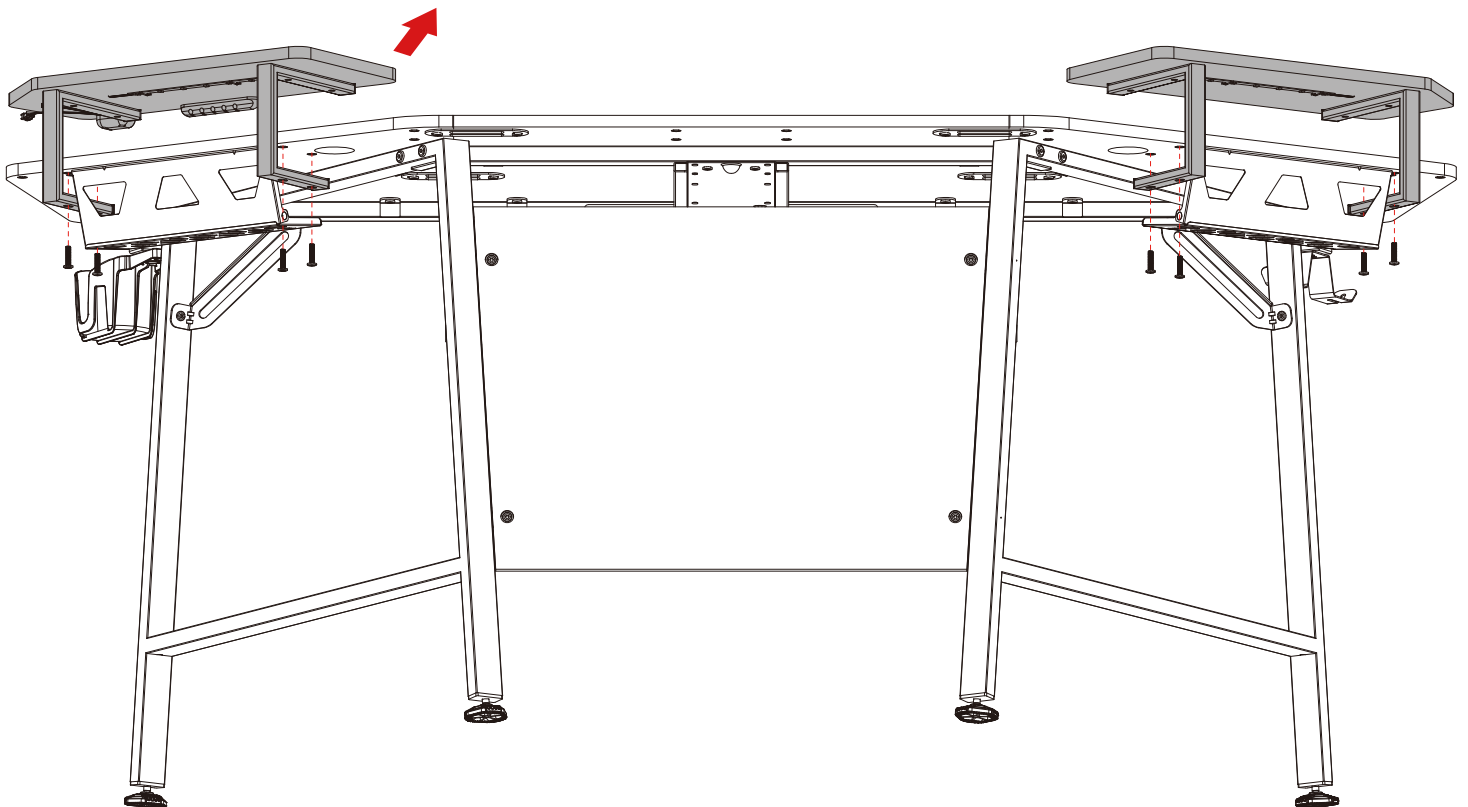
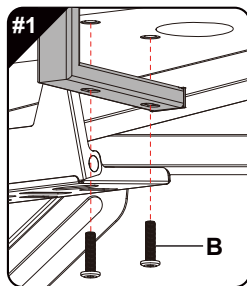
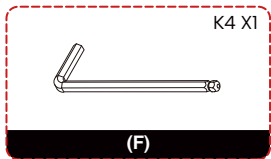
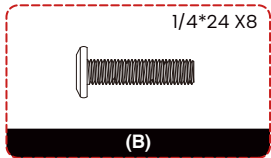
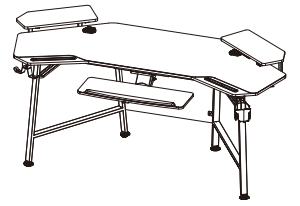

STEP 22

LEFT/RIGHT SHELF INSTALLATION PLAN II

PLAN D'INSTALLATION DE L'ÉTAGÈRE GAUCHE/DROITE II

SOLUCIÓN DE INSTALACIÓN DE LA ESTANERÍA IZQUIERDA/DERECHA II

左/右小层板安装方案二

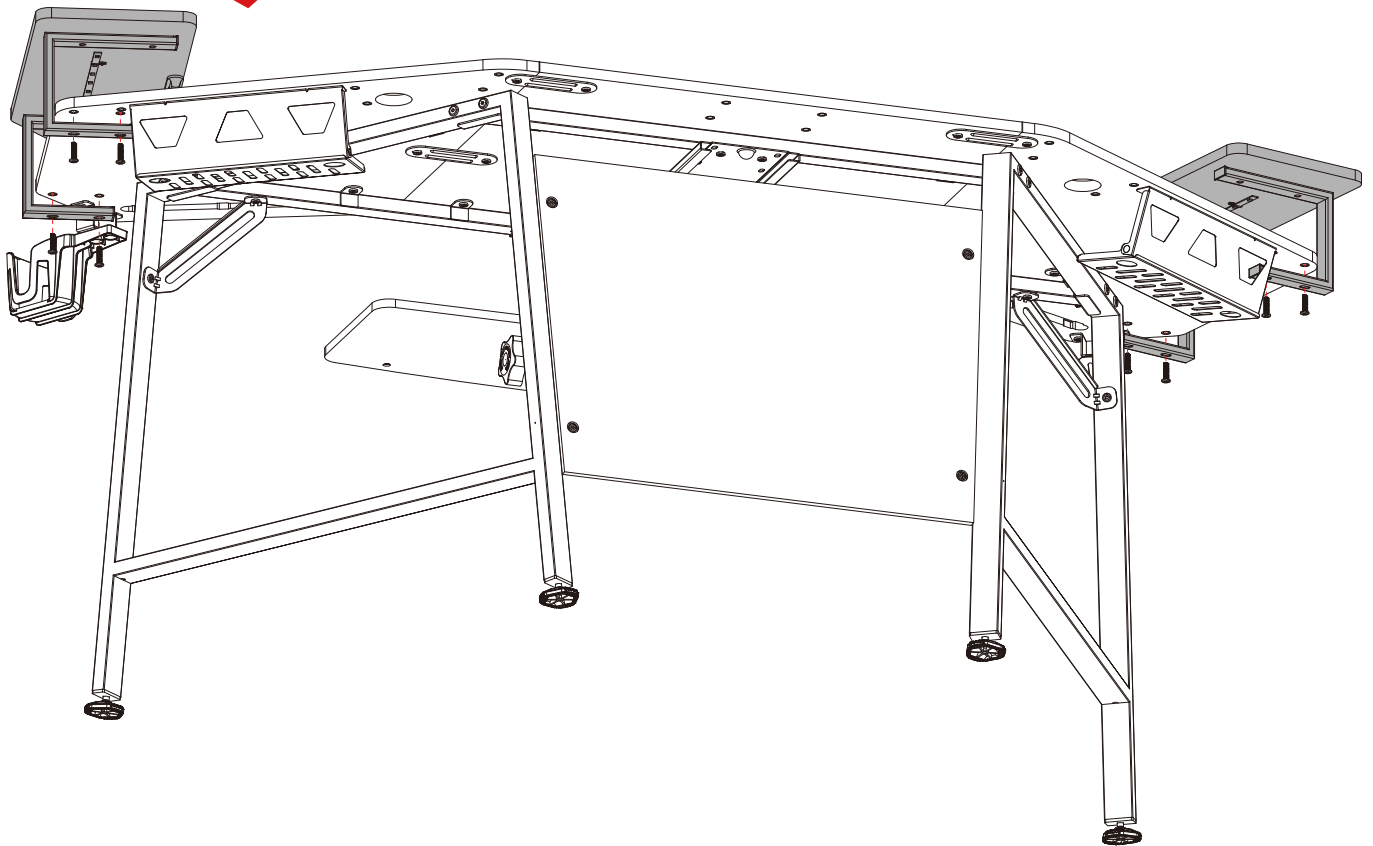
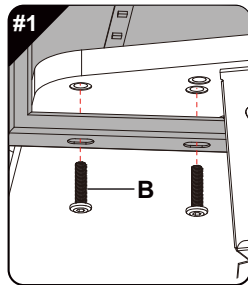
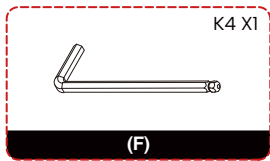
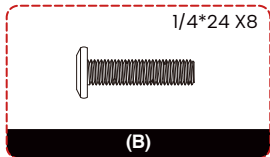
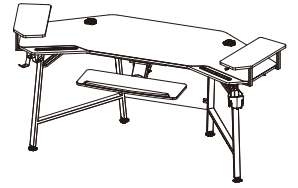

STEP 23

LEFT/RIGHT SHELF INSTALLATION PLAN III

PLAN D'INSTALLATION DE L'ÉTAGÈRE GAUCHE/DROITE III

SOLUCIÓN DE INSTALACIÓN DE LA ESTANERÍA IZQUIERDA/DERECHA III

左/右小层板安装方案三

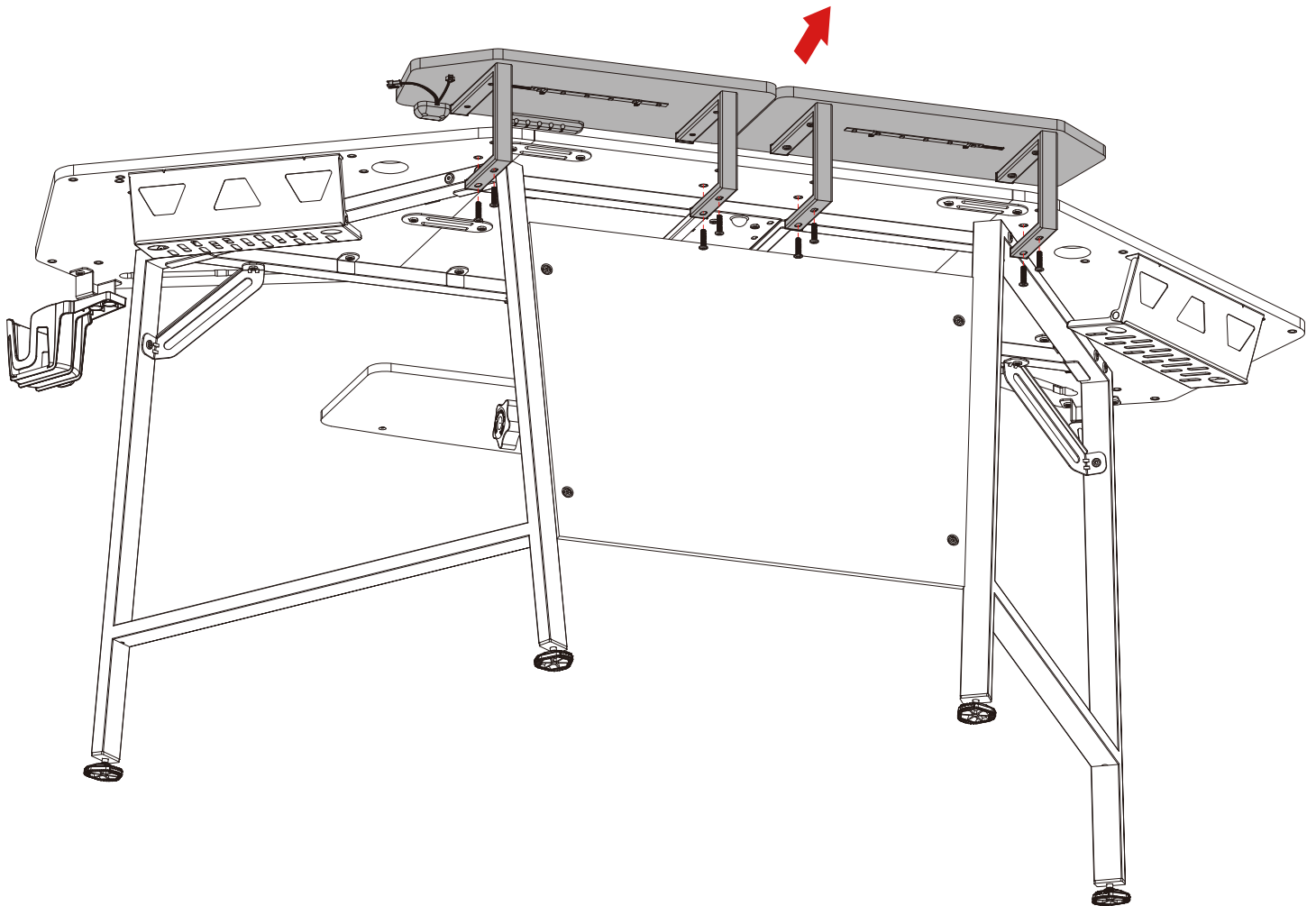
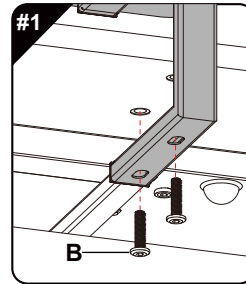
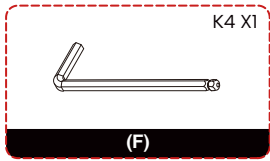
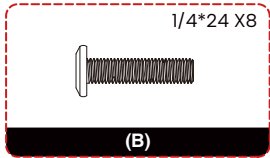
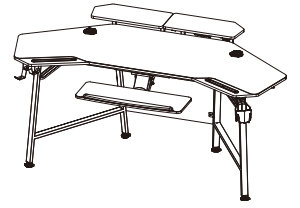

STEP 24

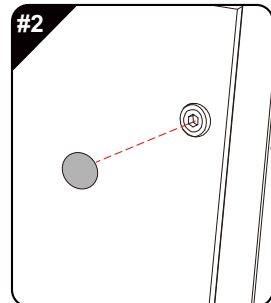
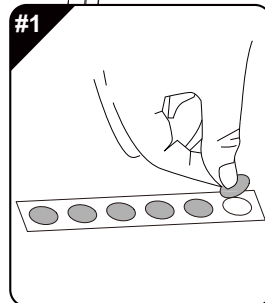
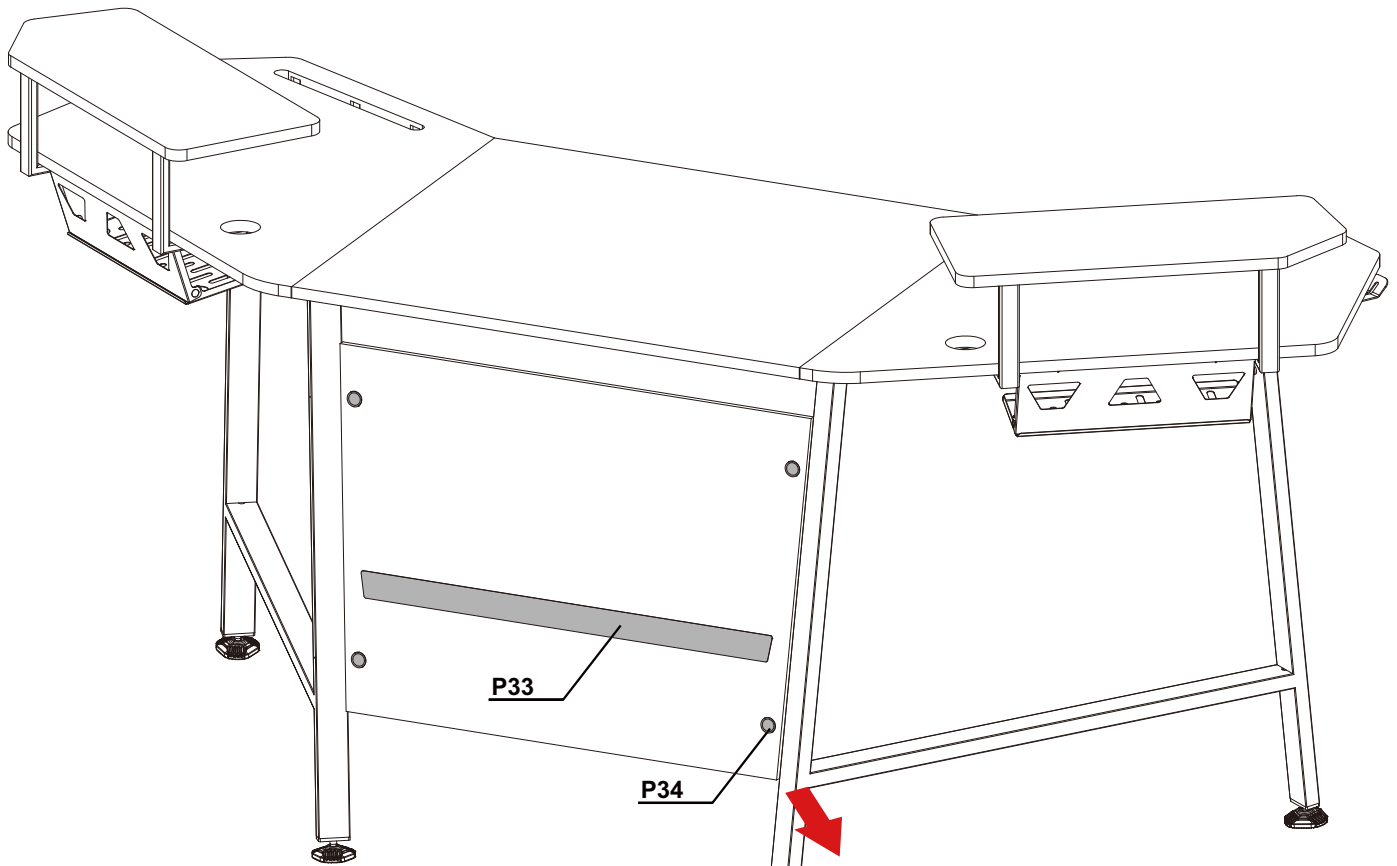
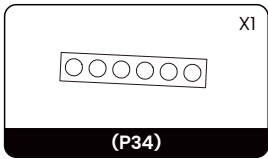
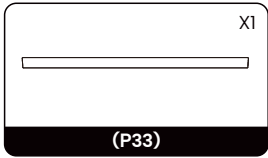

STEP 25

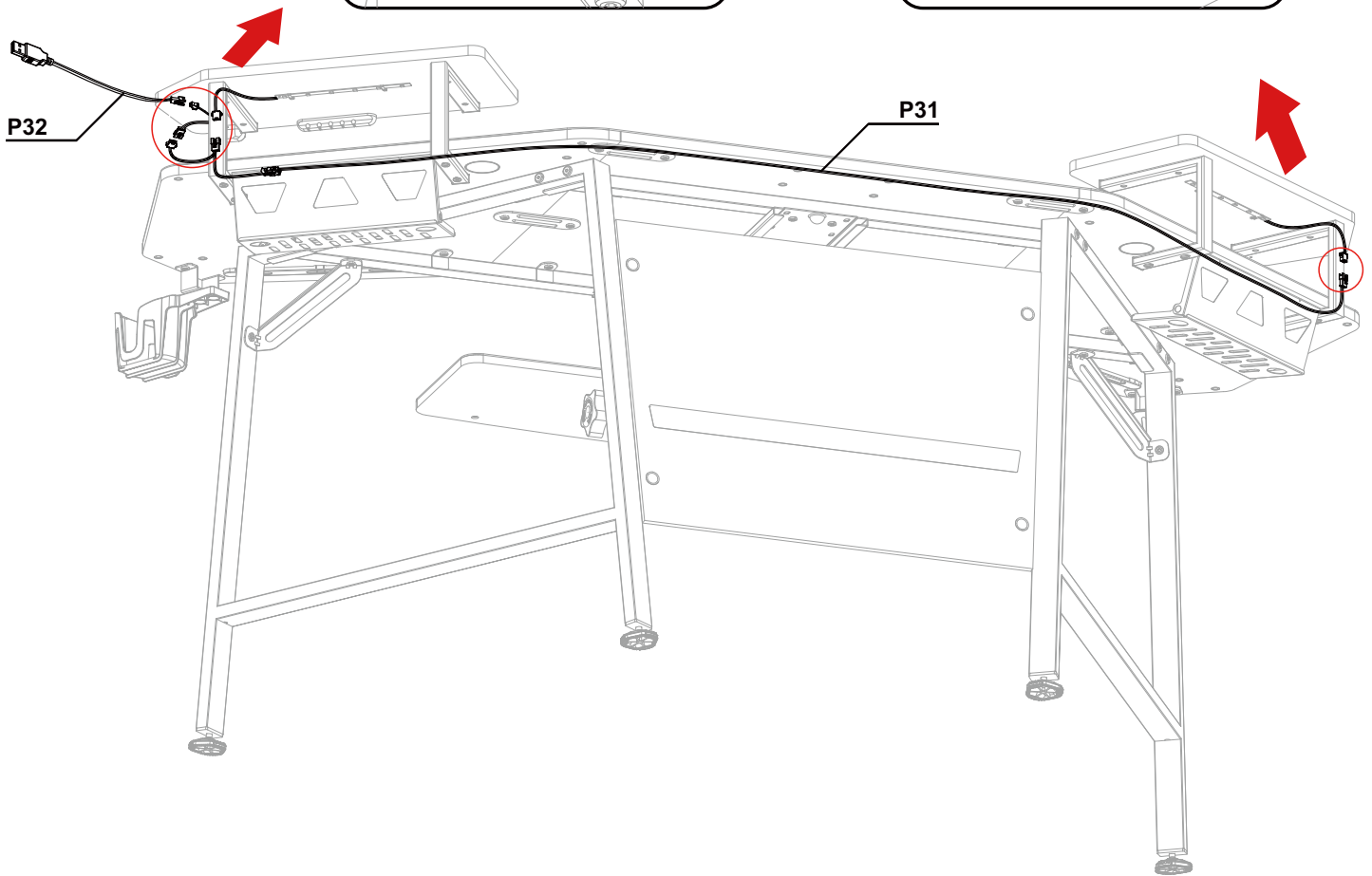
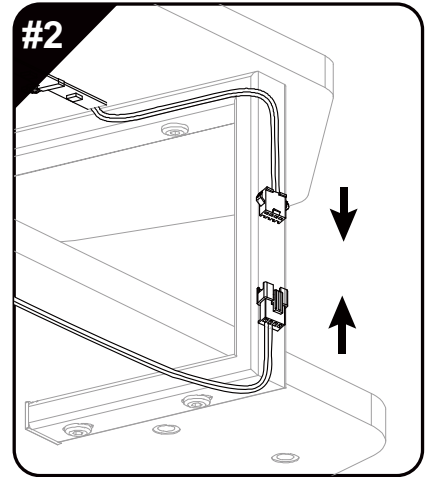
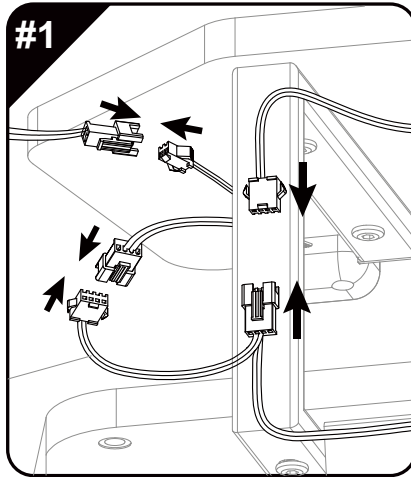
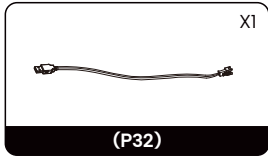
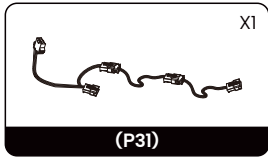

STEP 26

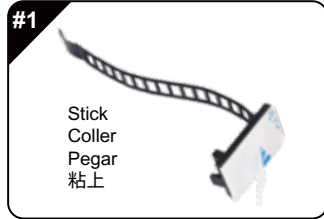
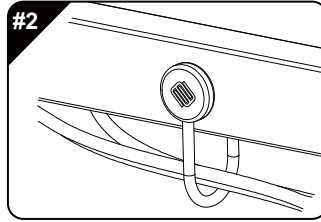
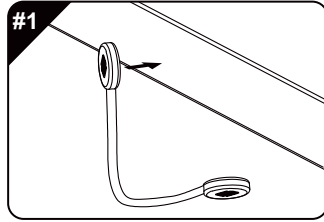
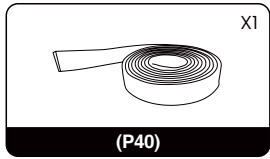
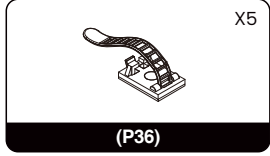
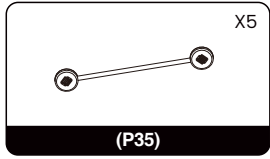

Cut as needed
Coupez selon les besoins
Cortar según sea necesario
根据需要自由裁剪

STEP 27

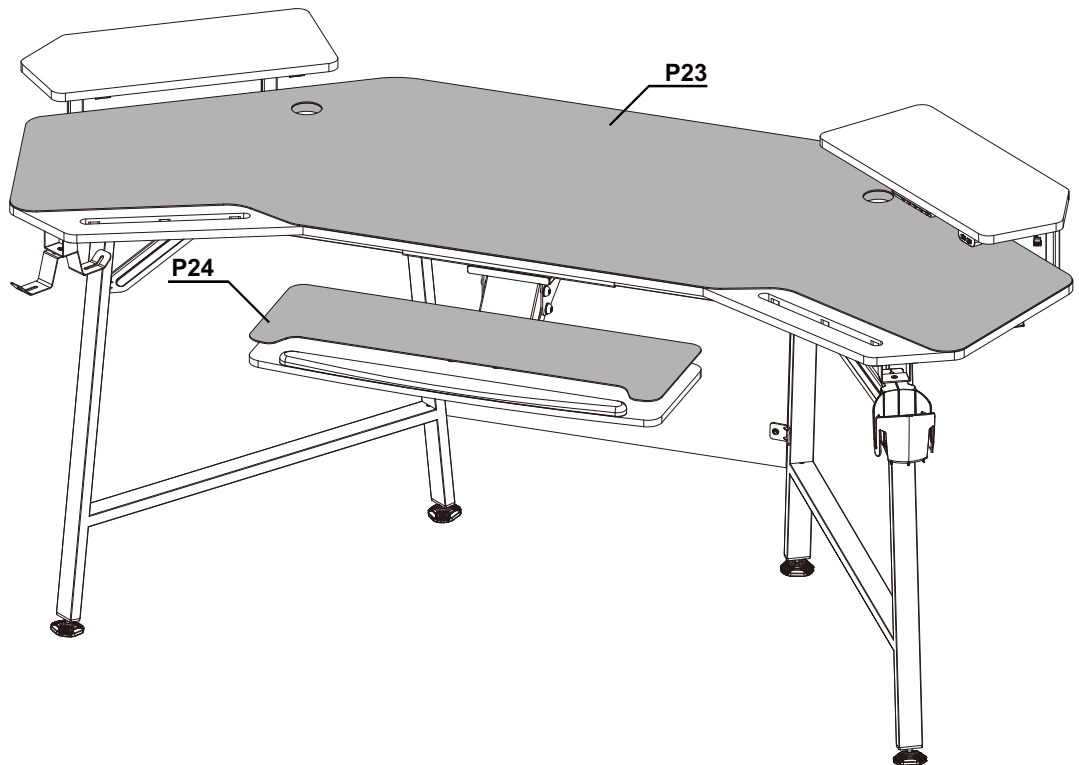
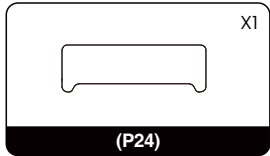
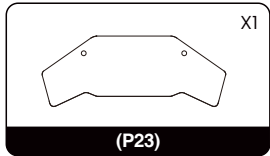

STEP 28

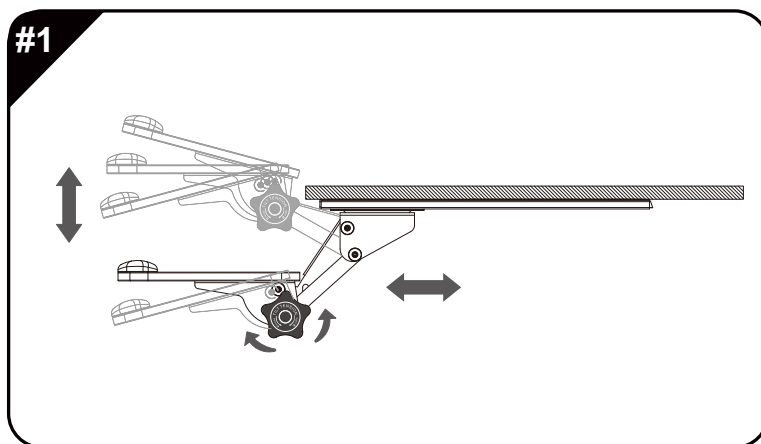
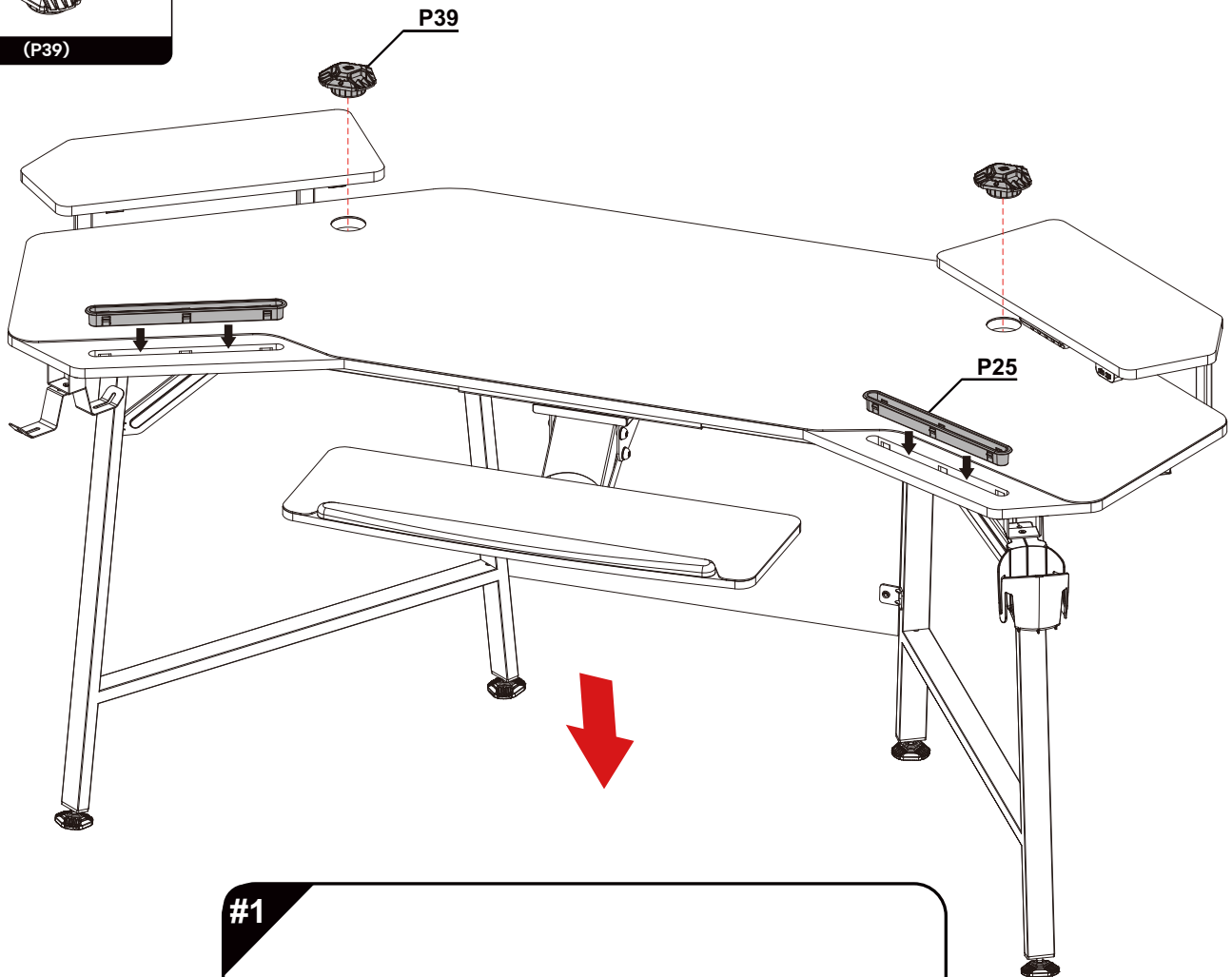
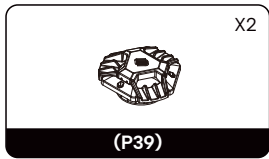
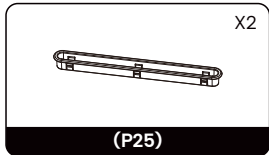

LIGHTS OPERATING INSTRUCTIONS

INSTRUCTIONS D'UTILISATION DES FEUX

INSTRUCCIONES DE USO DE LAS LUCES

灯光操作方法

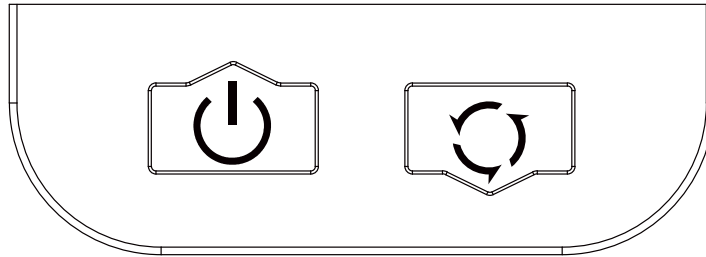

1. Change lighting modes: when the desk is on, press "↻" to change modes. Each press will lead to a different mode. 14 modes are available.
2. Turn on/off the lights: when the lights are on, you can turn them off by pressing "⏻" for about 3-4 seconds. When the lights are off, you can turn them on by pressing "⏻".
3. Memorize lighting modes: when the lights are off, the last lighting mode will be memorized automatically by the system. The next time when the lights are turned on, they will enter the memorized mode automatically.
4. Illuminating function: when the desk is on, press "↻" for about 3-4 seconds and the lights will enter the white light mode.

1. Changement de mode d'éclairage : lorsque le bureau est allumé, appuyez sur "↻" pour changer de mode. Chaque pression mène à un mode différent. 14 modes sont disponibles.
2. Allumer/éteindre les lumières : lorsque les lumières sont allumées, vous pouvez les éteindre en appuyant sur "⏻" pendant environ 3-4 secondes. Lorsque les lumières sont éteintes, vous pouvez les allumer en appuyant sur "⏻".
3. Mémoriser les modes d'éclairage : lorsque les lumières sont éteintes, le dernier mode d'éclairage est automatiquement mémorisé par le système. La prochaine fois que les lumières seront allumées, elles entreront automatiquement dans le mode mémorisé.
4. Fonction d'éclairage : lorsque le bureau est allumé, appuyez sur "↻" pendant environ 3-4 secondes et les lumières passeront en mode lumière blanche.

1. Cambiar los modos de iluminación: cuando el escritorio esté encendido, pulse "↻" para cambiar de modo. Cada pulsación le llevará a un modo diferente. Hay 14 modos disponibles.
2. Encender/apagar las luces: cuando las luces están encendidas, puede apagarlas pulsando "⏻" durante unos 3-4 segundos. Cuando las luces están apagadas, puede encenderlas pulsando "⏻".
3. Memorizar modos de iluminación: cuando las luces están apagadas, el último modo de iluminación será memorizado automáticamente por el sistema. La próxima vez que se enciendan las luces, entrarán automáticamente en el modo memorizado.
4. Función de iluminación: cuando la mesa está encendida, pulse "↻" durante unos 3-4 segundos y las luces entrarán en el modo de luz blanca.

1. 按键切换模式功能: 桌子通电后, 按切换键 "↻" 按键进行模式切换, 每按一次灯带会进入一次不同的灯光模式, 共14种模式。
2. 关闭灯光功能: 开灯状态, 长按电源键 "⏻" 大概3-4秒, 可以把灯光关闭。灯光关闭后, 按一下电源键 "⏻" 即可打开灯光。
3. 记忆灯光模式功能: 每次关机或者突然掉电之后, 控制器会自动保存掉电前用户设置好的灯光模式, 若下次重新通电时, 就会直接进入上次断电前设置好的灯光模式。
4. 照明功能: 桌子通电后, 长按切换键 "↻" 大概3-4秒, 会进入白光照明模式。