



ASSEMBLY INSTRUCTIONS

www.eurekaergonomic.com

MODEL # ERK-AED-E63B

E63 FIXED ANCHOR DESK

E63 TABLE D'ANCRAGE FIXE

E63 PLATAFORMA DE ANCLAJE FIJA

E63固定主播桌

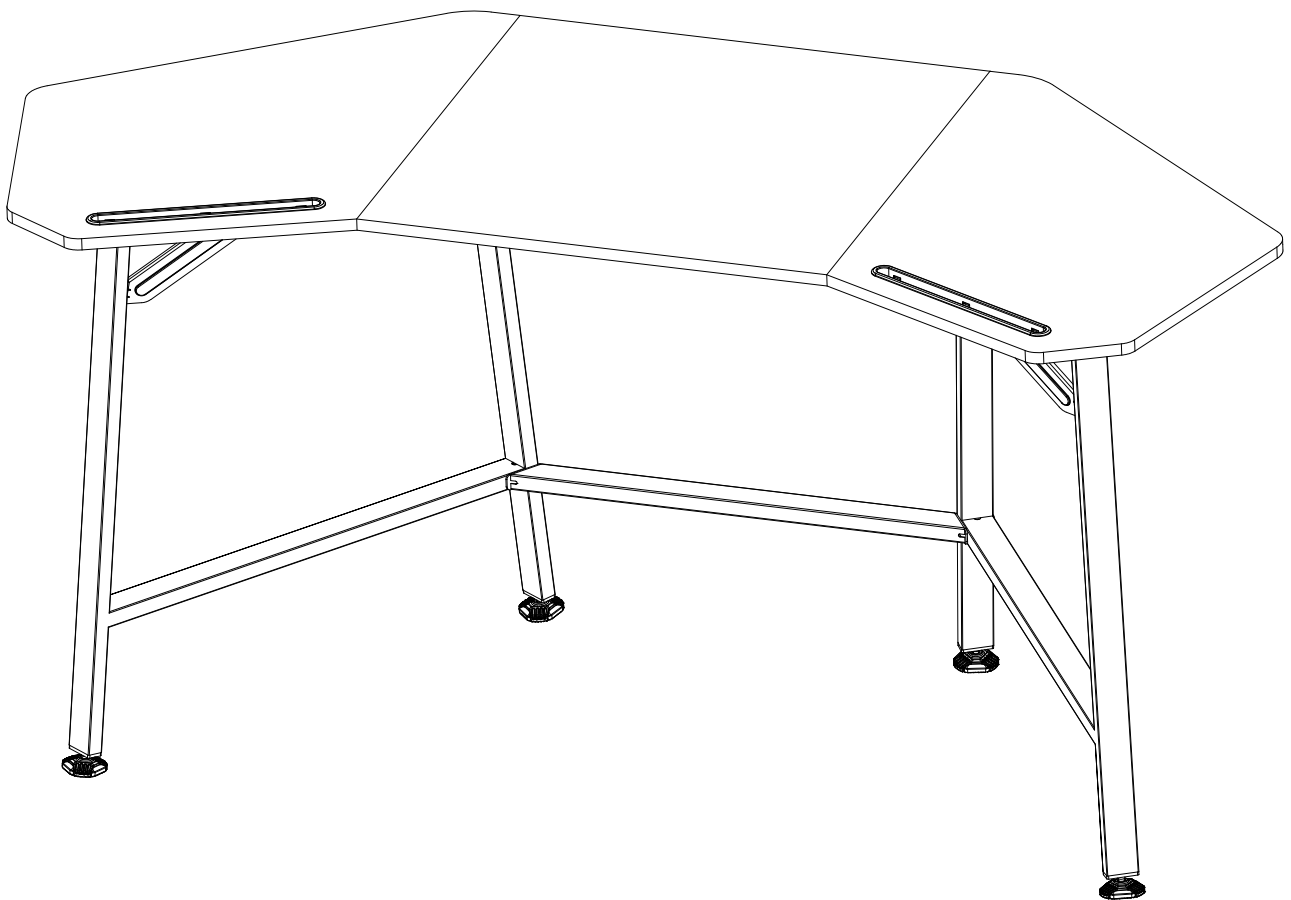

If you need to return the goods, please keep all the packaging materials and return it in the original packaging!

Si vous devez retourner la marchandise, veuillez conserver tous les matériaux d'emballage et le retourner dans l'emballage d'origine!

Si necesita devolver los productos, conserve todos los materiales de embalaje y devuélvalos en el embalaje original!

如需退货请保留好所有包装材料，并按原包装包好退回!

PARTS / PIÈCES / PARTES / 部件清单

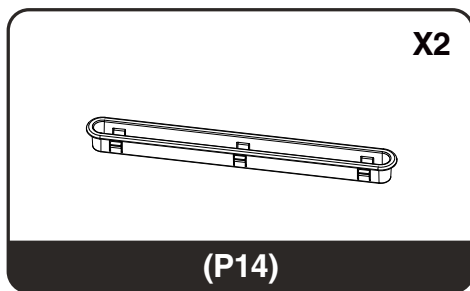
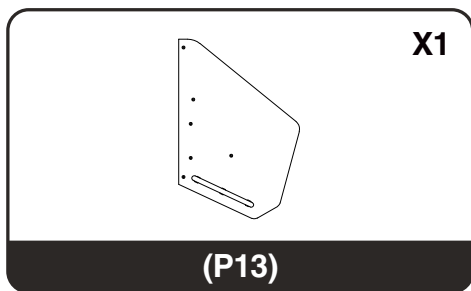
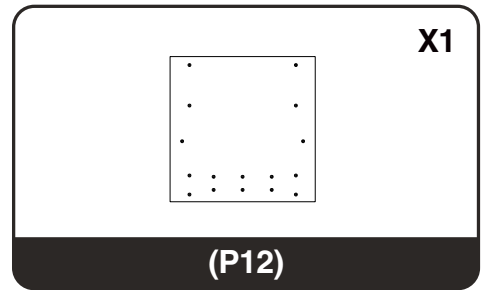
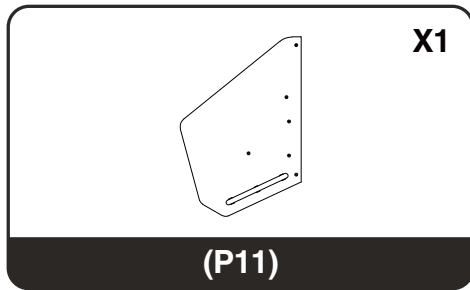
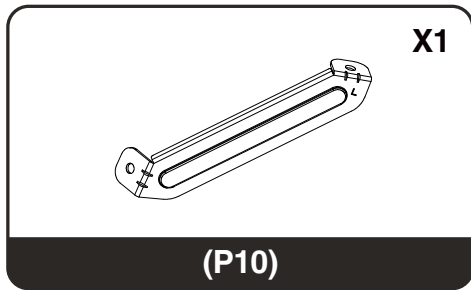
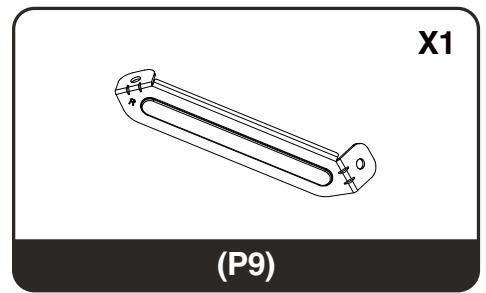
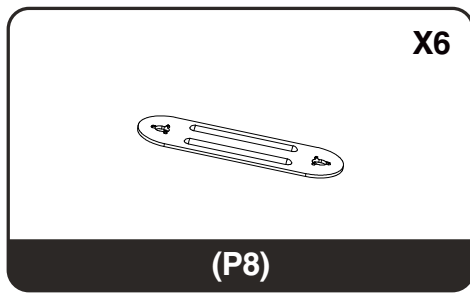
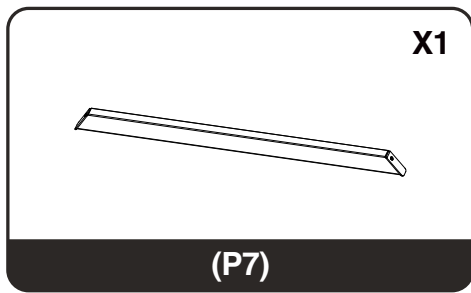
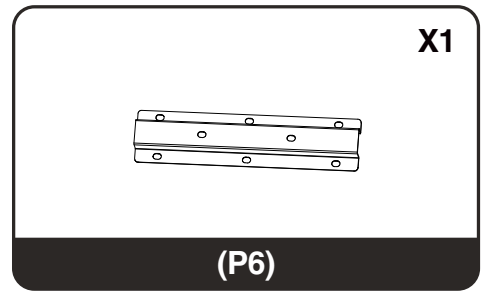
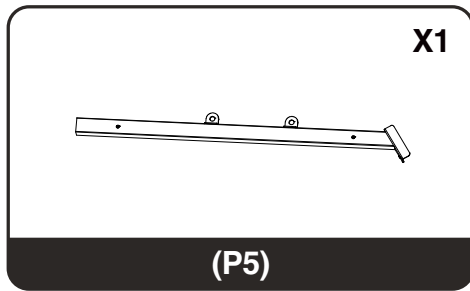
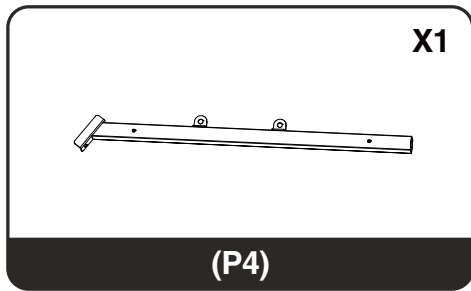
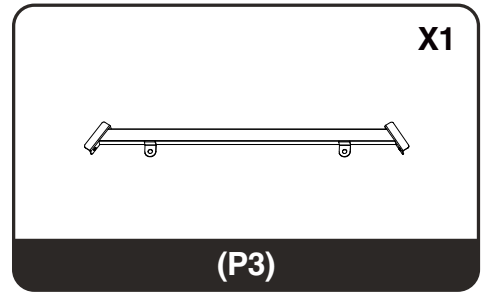
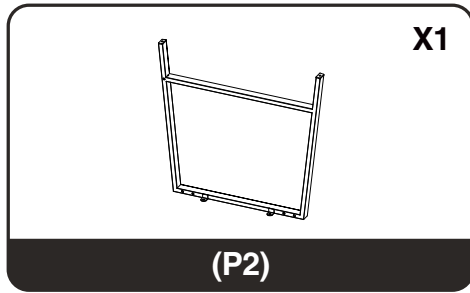
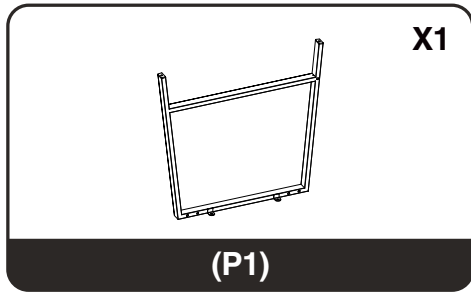

HARDWARE / MATÉRIEL / HARDWARE / 配件清单

1/4*51mm X10

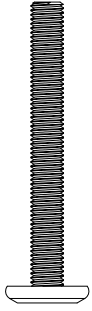

(A)

1/4*12mm X34

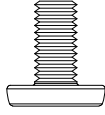

(B)

X4

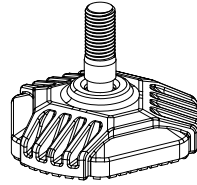

(C)

K4 X1

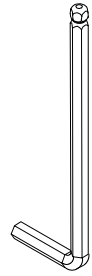

(D)



Do not tighten the screws until all of them are screwed into the holes.
Ne serrez pas les vis avant qu'elles ne soient toutes vissées dans les trous.
No apriete los tornillos hasta que todos estén atornillados en los agujeros.
安装时先不要把螺丝拧紧，等所有螺丝都拧到螺纹孔上再将全部螺丝拧紧。

ASSEMBLY INSTRUCTIONS

INSTRUCTIONS DE MONTAGE

INSTRUCCIONES DE MONTAJE

安装步骤

STEP 1

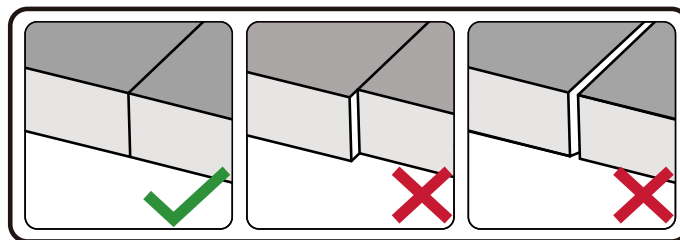
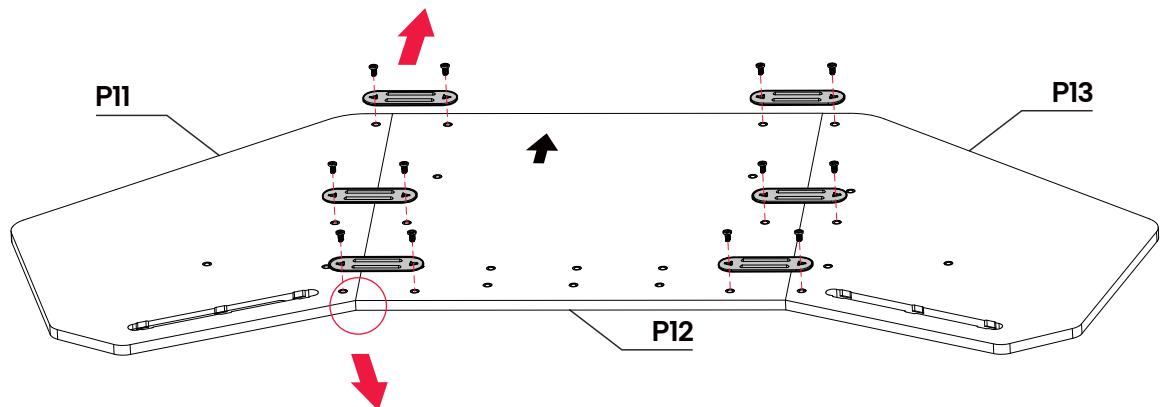
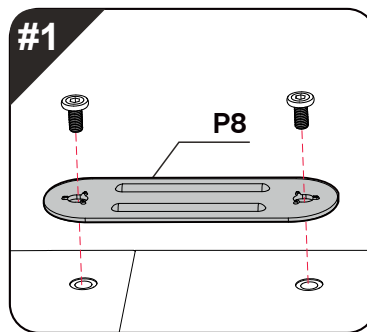
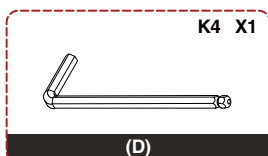
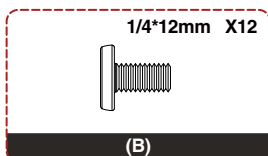
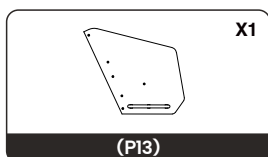
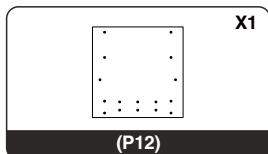
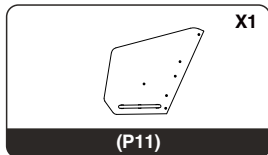
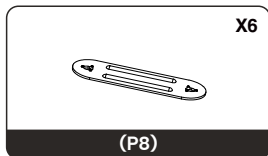

STEP 2

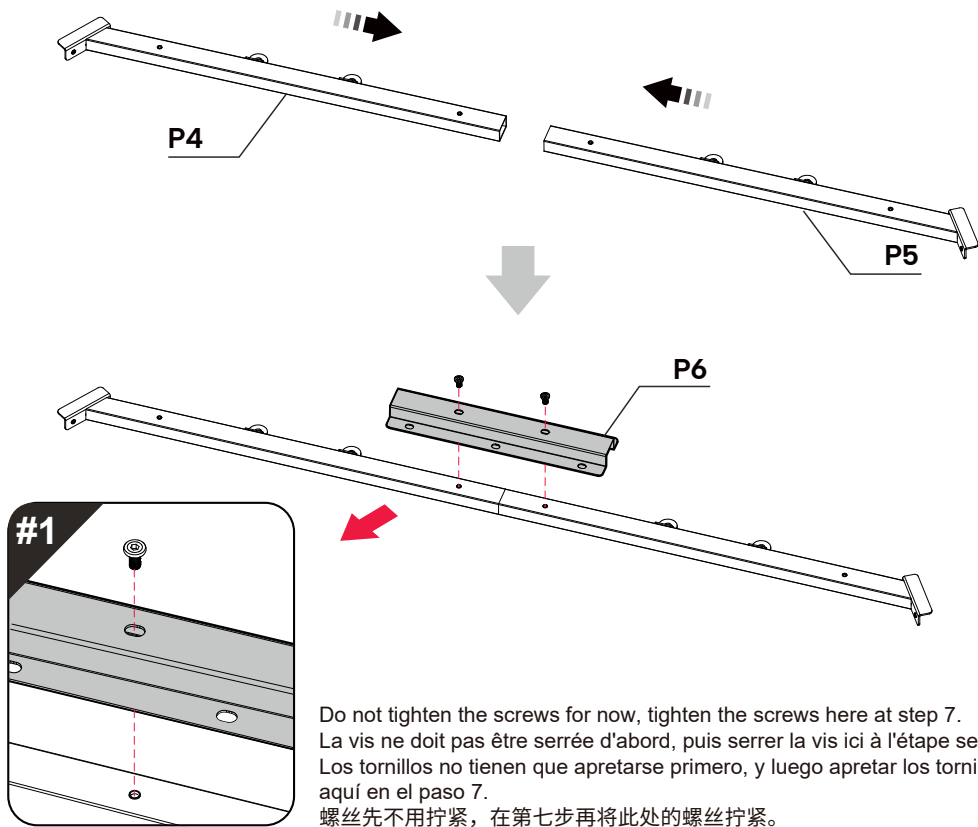
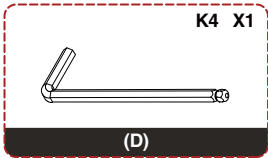
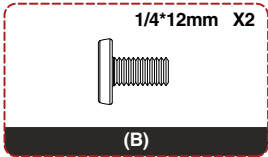
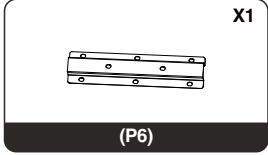
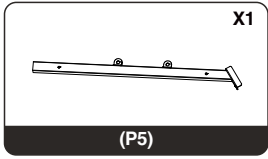
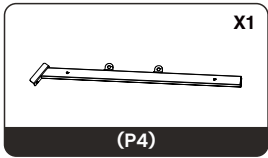

STEP 3

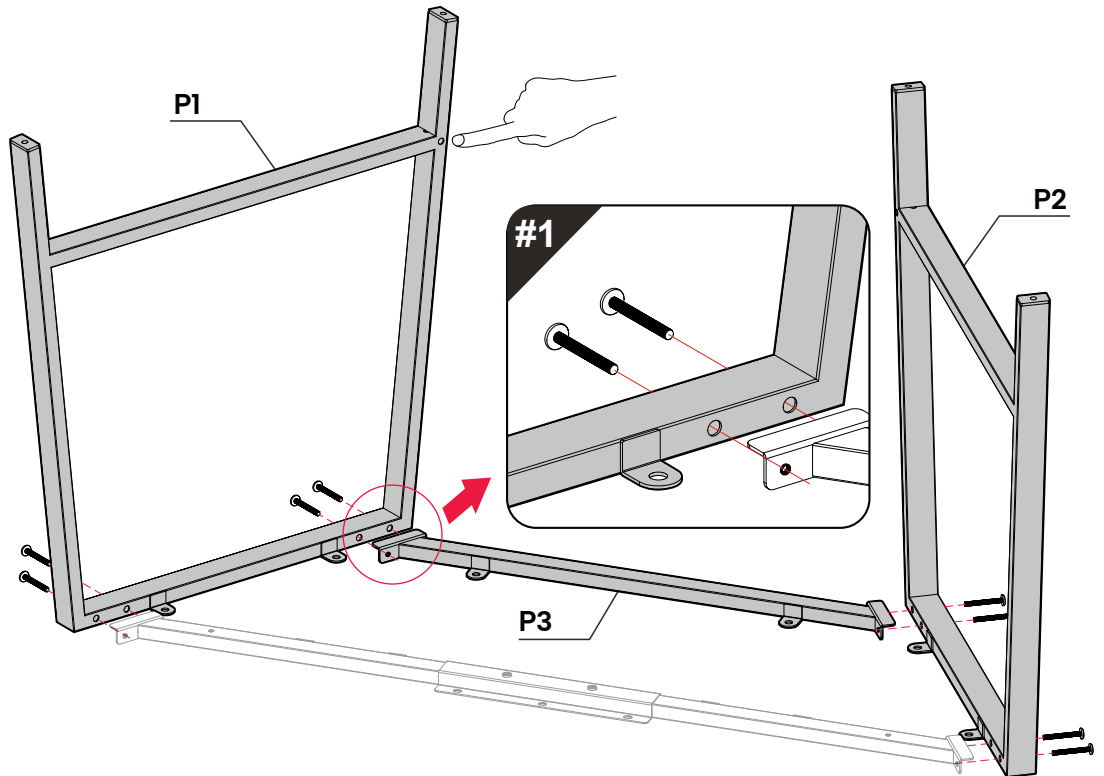
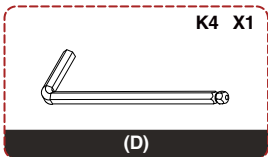
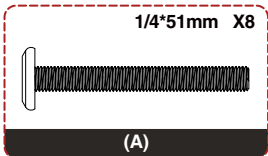
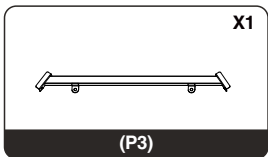
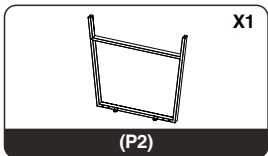
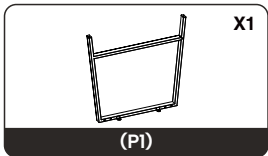

STEP 4

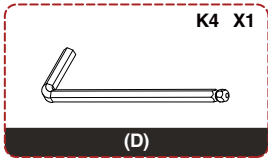
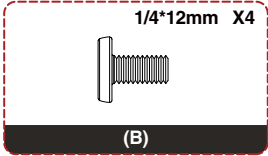
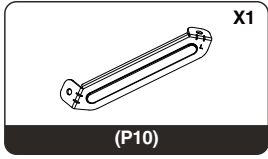
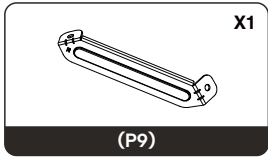

Turn the assembled table legs around.
Tournez les pieds de table assemblés dans la direction.
Gire las piernas de mesa ensambladas en la Dirección.
将组装好的桌腿调转方向。

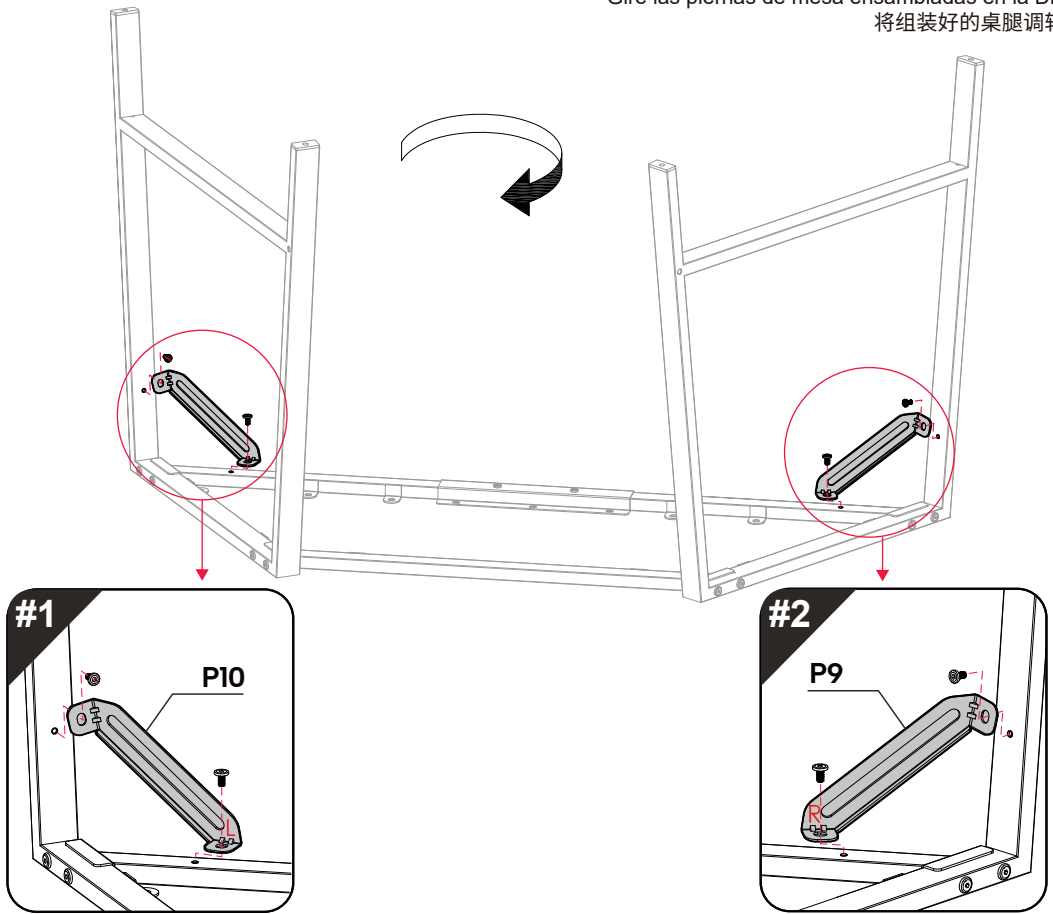

STEP 5

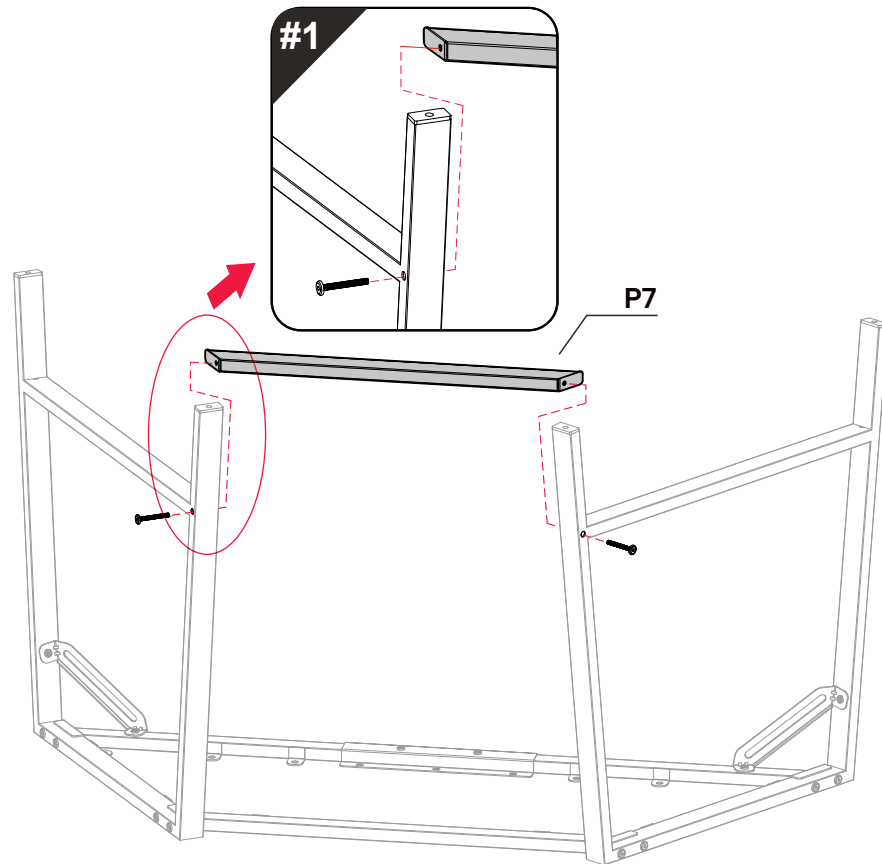
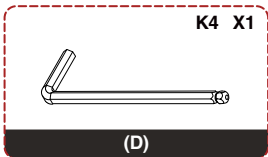
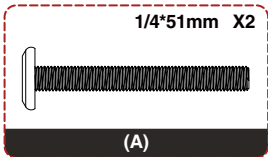
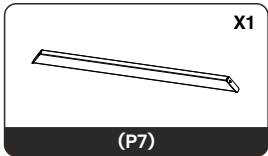

STEP 6

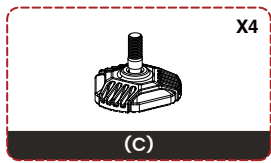

Turn the assembled table legs around.
Tournez les pieds de table assemblés dans la direction.
Gire las piernas de mesa ensambladas en la Dirección.
将组装好的桌腿调转方向。

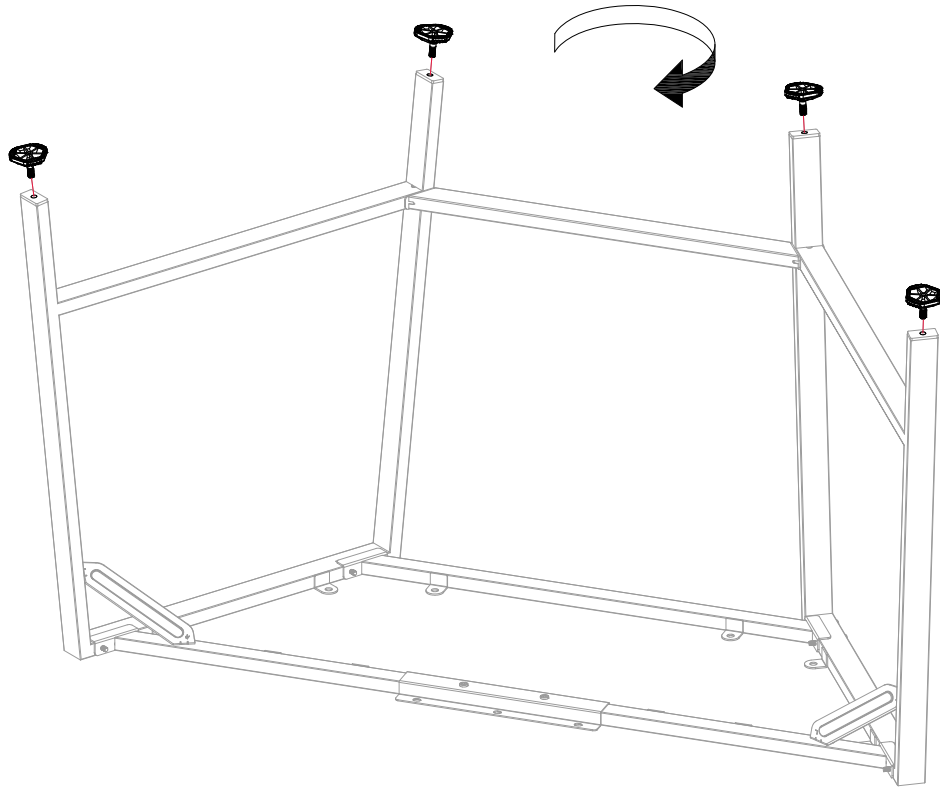

STEP 7

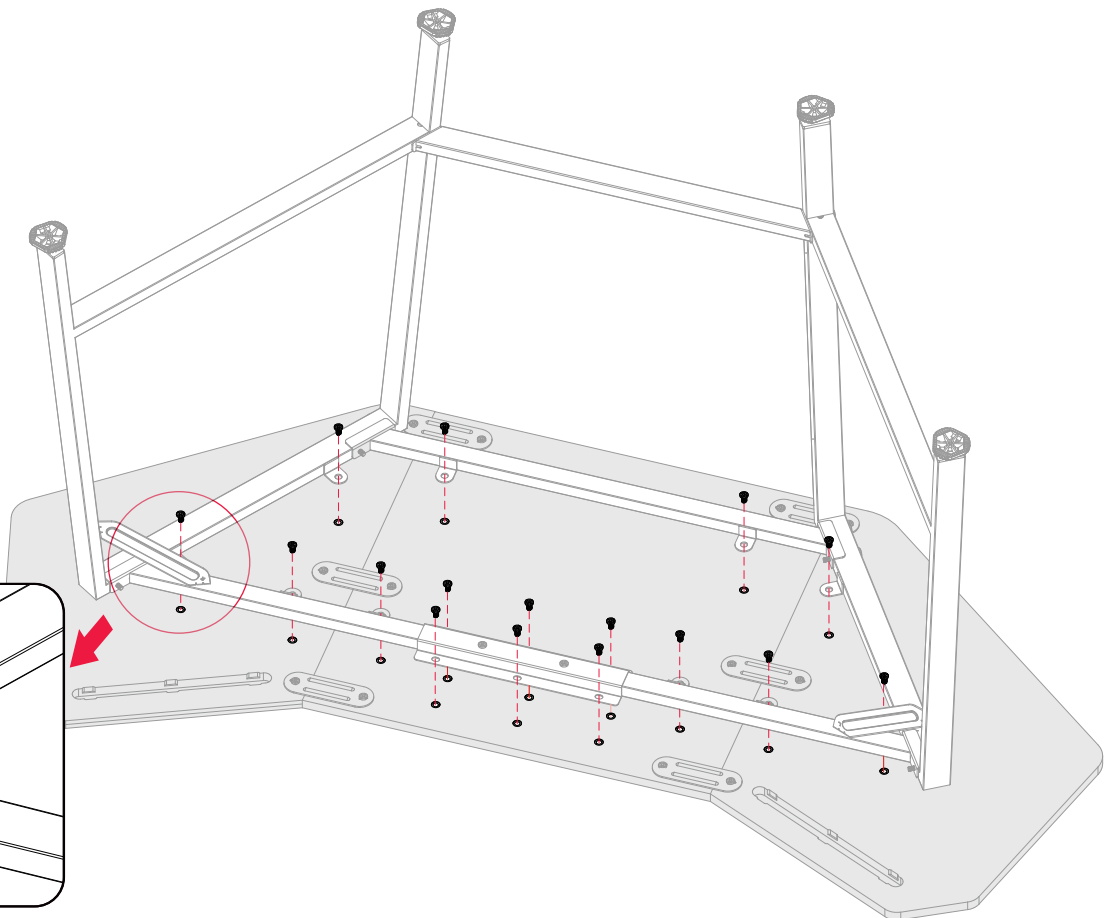
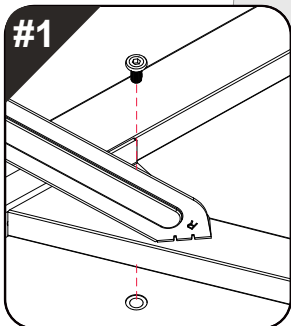
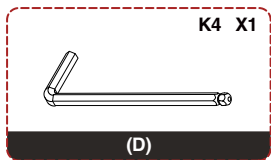
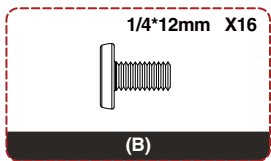

STEP 8

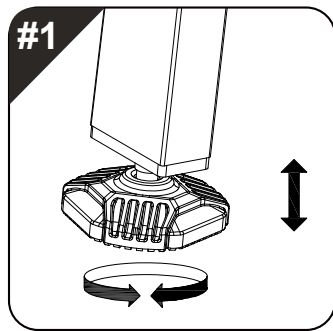
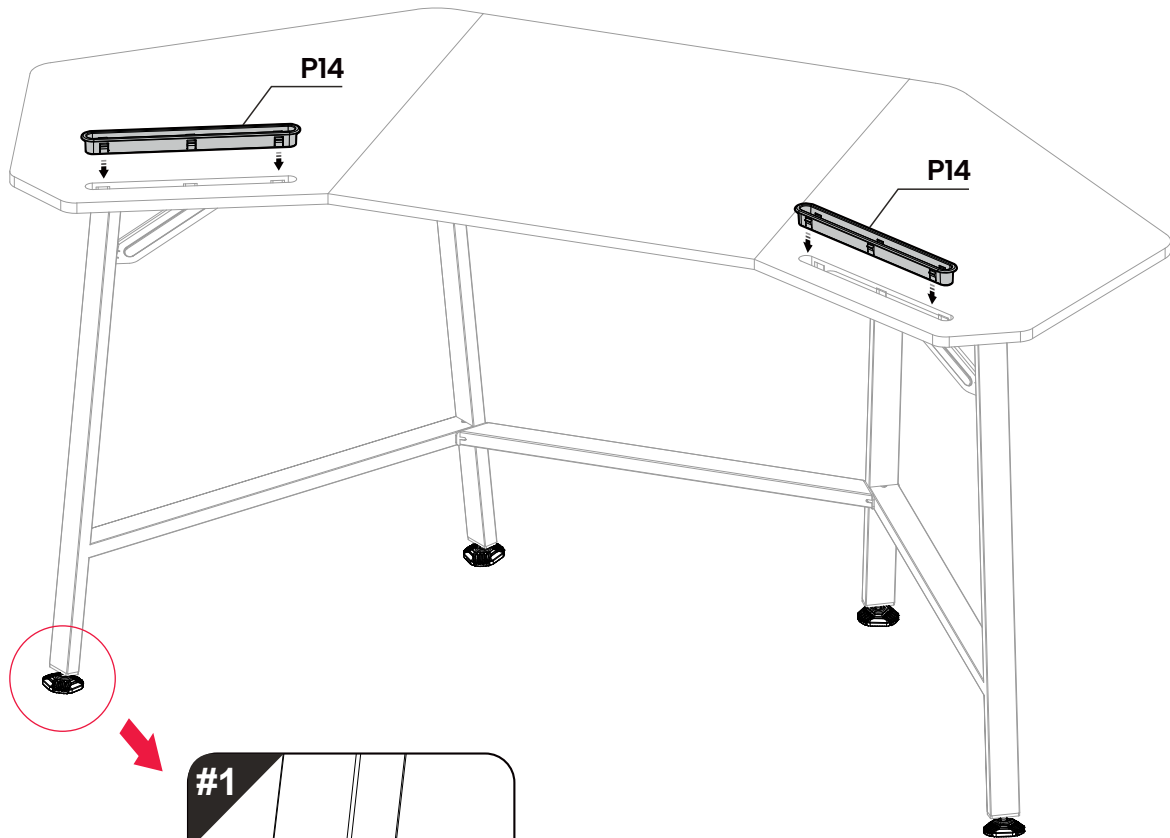
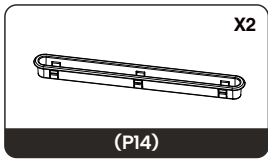

Adjust to horizontal direction.
Ajustement à l'horizontale.
Ajustar a la dirección horizontal.
调整至水平方向。