

Shade N' Shelters

Owner's Manual

Lexington

9' x 11' Soft Top Gazebo

Model Number: LEX/GAZ-2
SKU Number: 101641932





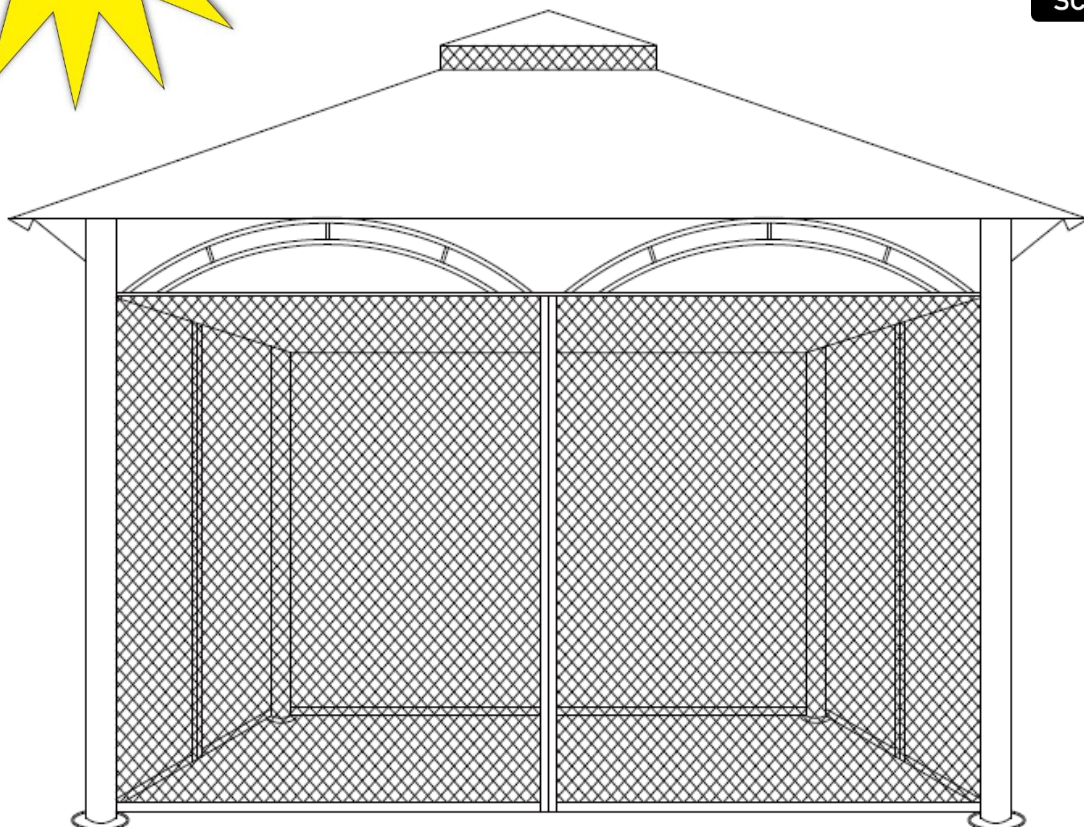





Scan For Video
Assembly Instructions!

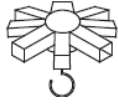



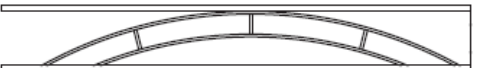

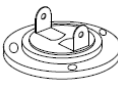
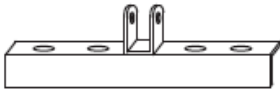
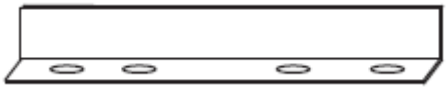

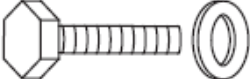
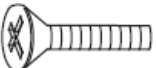

Note: This gazebo frame is designed to be used as a permanent fixture. Remove canopy when not in use or during high winds, rain or snow.

Parts List

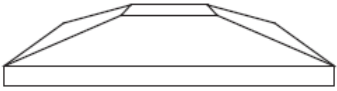
Lexington 9' x 11' Soft Top Gazebo

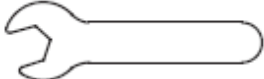
Letter	Illustration	Description	Qty.
A		Center Roof Connector	1
B		Corner Roof Support-Long (86 1/2")	4
C		Side Roof Support-Short (57")	2
D		Side Roof Support-Medium (68")	2
E1		Short Cross-Beam (55 3/4")-Left	2
E2		Short Cross-Beam (55 3/4")-Right	2
F		Long Cross-Beam (90 1/2")	2
G		Base Plate	4
H		Top Connector Plate with "U" Bracket (for Short Cross-Beams)	2
I		Bottom Connector Plate (for Short Cross-Beams)	2
J		Vertical Corner Post	4
K		Small "U" Bracket for Vertical Corner Post and Long Cross-Beam	6

Letter	Illustration	Description	Qty.
L		Ground Stakes	12
M		M6 x 30mm Bolt with Washer, Nut Plastic Nut Cap	24
N		M6 x 15mm Bolt and Washer	24
O		M6 x 15mm Screw	6
P		Roof Vent Canopy	1
Q		Main Canopy	1
R		Mosquito Netting	4
S		Ring Connectors	52
T		Open Wrench	2
U		Allen Wrench	1

Assembly Instructions

Lexington 9' x 11' Soft Top Gazebo

Note: For video instructions please visit:

<https://shadenshelters.com/9-x-11-lexington-gazebo>

Important:

- Read all the instructions before assembly. Failure to do so may result in faulty assembly and potential injury.
- Before assembling the product, remove all protective materials, hardware kit(s), and identify all parts packed in the carton are present. (Note: If any part is missing or damaged, do not attempt to assemble). Contact Shade N' Shelters Customer Support. See page 9.
- Assemble on a stable level surface to avoid damage to gazebo and possible injury.
- Two people are required to assemble this product.
- Gazebo dimensions are measured from roof corner to roof corner.

WARNING: DO NOT TIGHTEN BOLTS UNTIL NOTED AFTER EACH STEP!

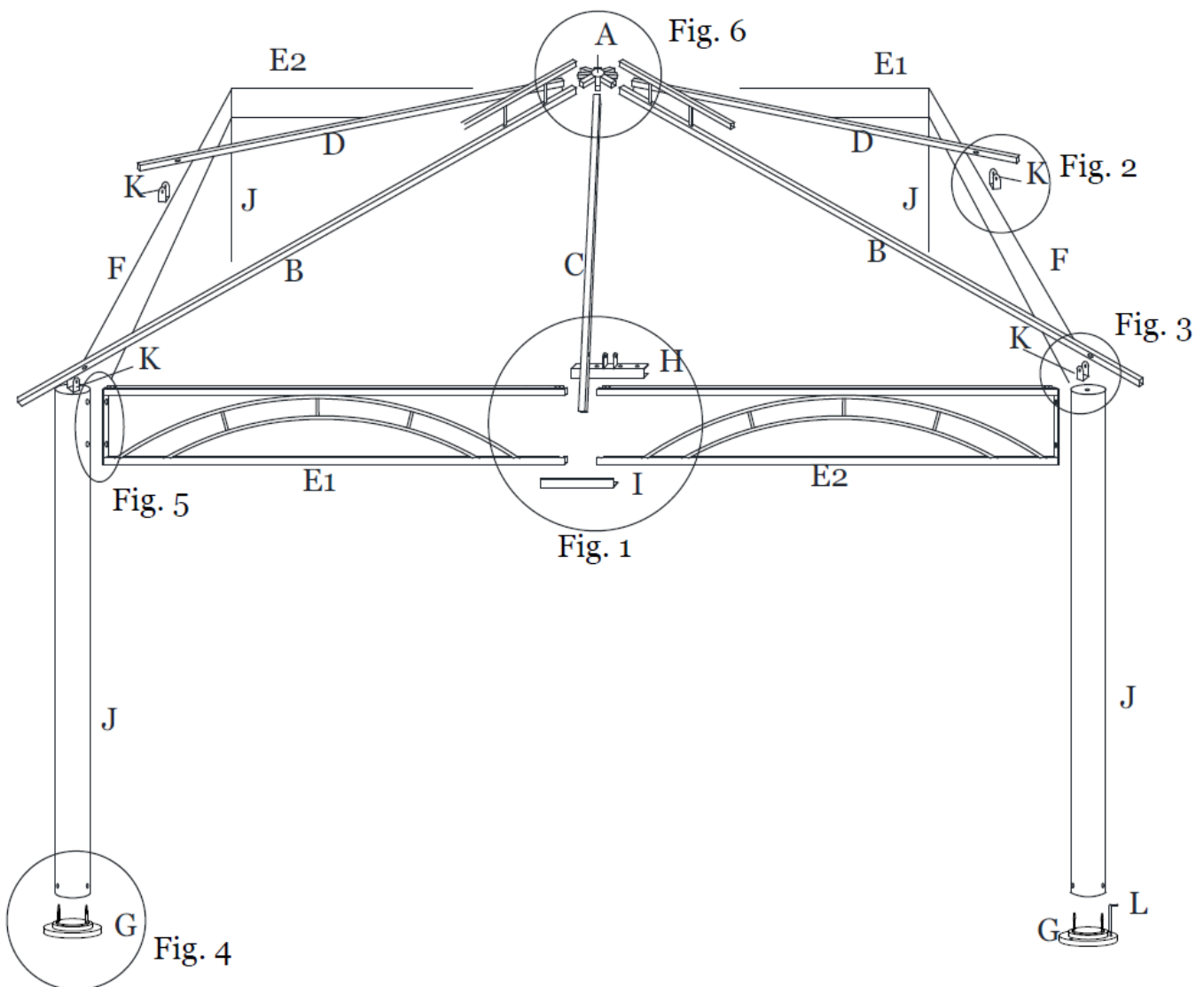

I. Cross-Beam Assembly:

Step 1: Attach the Short Cross Beam (E1) to the Short Cross Beam (E2) using the Top Connector Plate (H) and Bottom Connector Plate (I) using Bolt, Washers and Nut (M). See Figure 1.

Note: The round steel rail on the Cross-Beam is the top side.

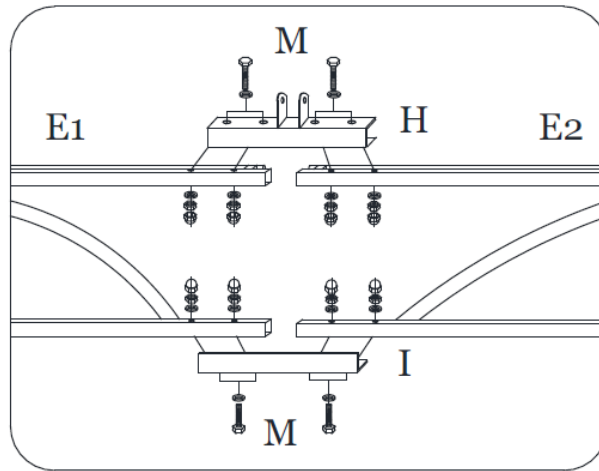

Figure 1

Step 2: Repeat for remaining Short Cross Beams (E1/E2).

Step 3: Attach Small “U” Bracket (K) to both Long Cross-Beams (F) using Screw (O). See Figure 2.

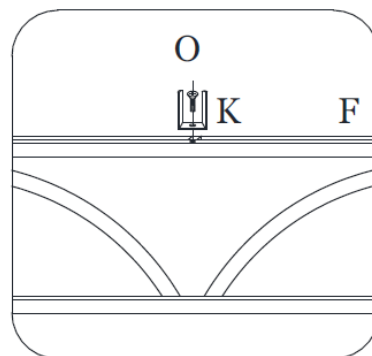

Figure 2

II. Side Frame Assembly:

Step 1: Attach Small “U” Brackets (K) to top of each Corner Post (J) using Screw (O). See Figure 3.

Note: Screws should only be finger-tight at this point to allow the “U” Bracket (K) to move so you can adjust the angle in Section III; Step 1.

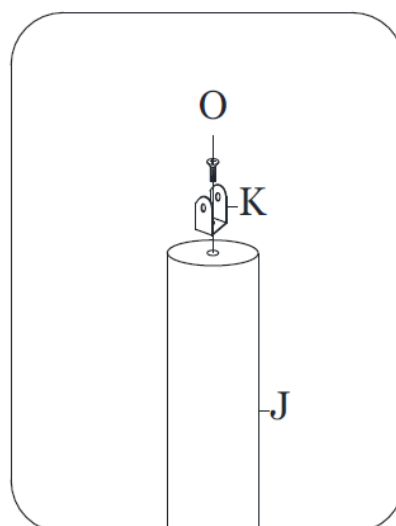

Figure 3

Step 2: Attach the Base Plates (G) to the Corner Post (J) using Bolts and Washers (N). See Figure 4.

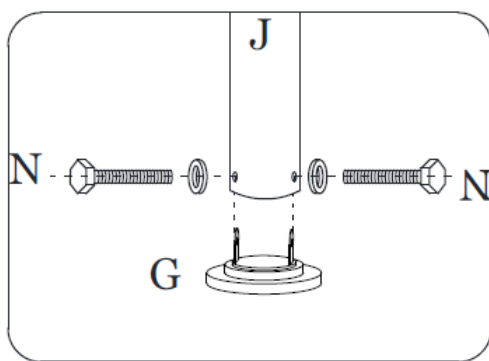

Figure 4

Step 3: Attach the 2 Assembled Short Cross-Beams (E1 and E2) and Long Cross-Beams (F) to the Corner Posts (J) with Bolt & Washer (N). See Figure 5.

Note: This step requires help from a third person.

Note: The round steel rail welded on the Cross-Beam must face the inside of the gazebo.

Note: The Assembled Short Cross-Beams are on opposite sides of the gazebo and the Long Cross-Beams are also opposite each other.

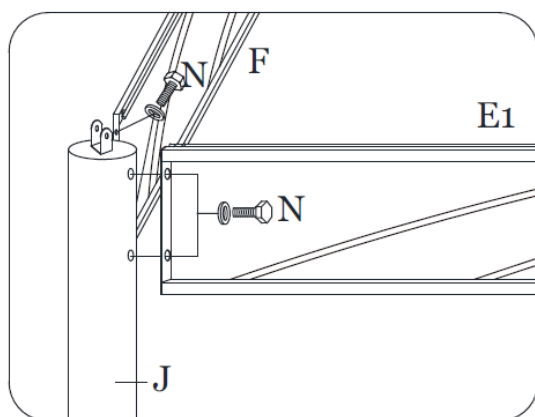

Figure 5

III. Roof Frame Assembly:

Step 1: Insert the “Push Button” end of the Long Corner Roof Support (B) to the Center Roof Connector (A) until “Push Button” locks. See Figure 6. Align the opposite end of the Corner Roof Support (B) with the Small “U” Bracket (K) on the Corner Posts (J).

Secure the Small “U” Bracket (K) by tightening Screw (O) then attach the Long Corner Roof Support (B) with Bolt, Washers and Nut (M). See Figure 7.

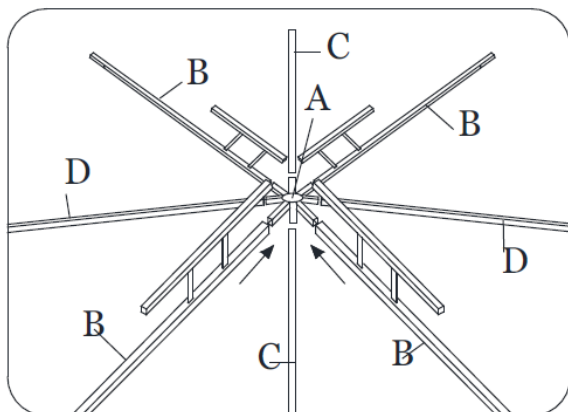

Figure 6

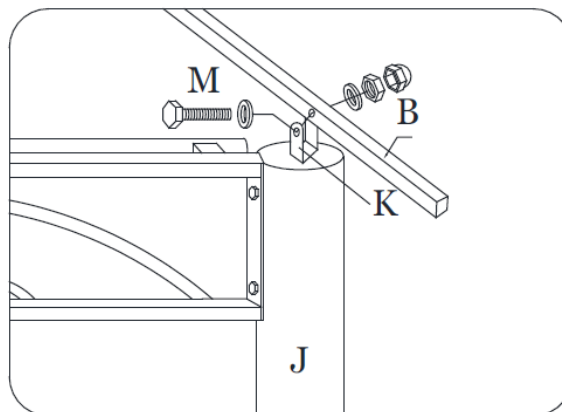

Figure 7

Step 2: Insert the “Push Button” end of the “Short” Roof Support (C) into the Center Roof Connector (A) and attach to the “U” Bracket (K) on top of the Assembled Cross-Beams (E1 and E2) using Bolt, Washers, and Nut (M). See Figure 8.

Note: Roof Assembly requires a Step Ladder and help from a third person.

Step 3: Insert the “Push Button” end of the “Medium” Roof Support (D) into the Center Roof Connector (A) and attach to Long Cross-Beams (F) using Bolt, Washers, and Nut (M). See Figure 9.

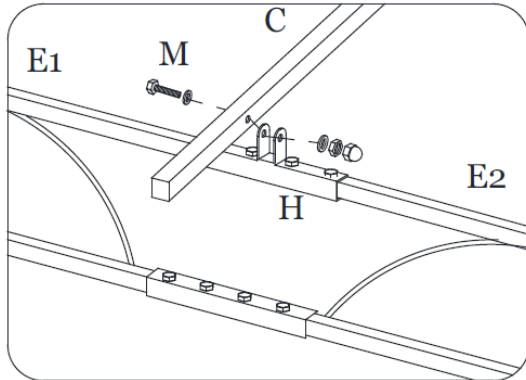

Figure 8

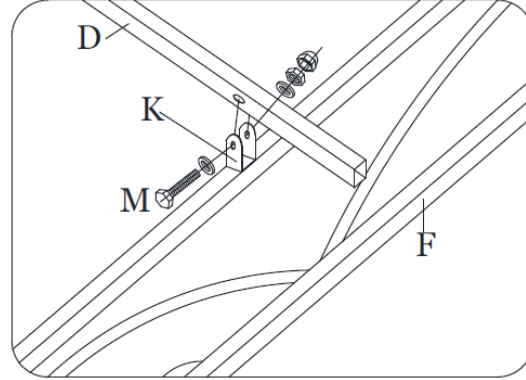

Figure 9

IV. Canopy/Valance Assembly:

Step 1: Place the Main Canopy (Q) over the Roof. Leave the Main Canopy loose until Roof Vent Canopy has been installed. **Note:** Roof Vent Frame must remain exposed. Roof Vent Frame is welded to the top of Roof Supports (B).

Step 2: Place Roof Vent Canopy (P) over Roof Vent Frame and secure to the ends of the Roof Vent Frame. See Figure 11.

Step 3: Firmly secure the Main Canopy (Q) to the ends of the Main Roof Support Frame (B, C, and D). See Figure 10.

Step 4: Insert the Valance between the Round Steel Rail and the Cross-beam.

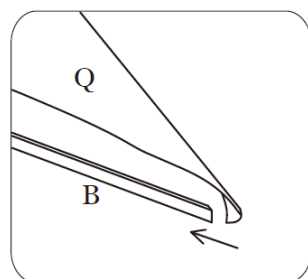
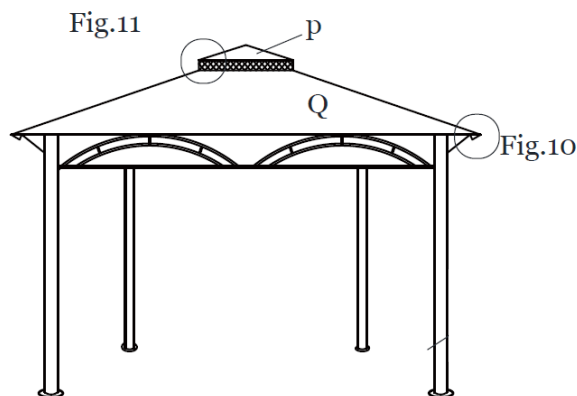

Figure 10

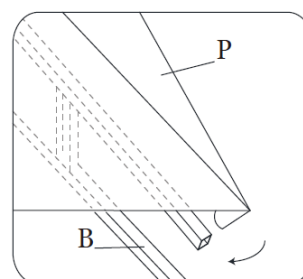

Figure 11

V. Mosquito Netting Assembly:

Step 1: Before attaching the Mosquito Netting (R), align all four sections on the ground next to the gazebo.

Make sure the zippers are aligned in the center of each opening. The Fabric Tie-Backs sewn to the Mosquito Netting (R) also must be aligned with each Corner Post (J).

Step 2: Insert the Plastic Ring Connectors (S) thru the Elastic Bands on the Mosquito Netting and attach to the Round Steel Rail on the inside of the Cross-Beams. Snap the ring firmly together to lock. Repeat for each section of Mosquito Netting (R). See Figure 12.

Step 3: To open the Mosquito Netting (R), unzip at the center and attach to the Corner Posts (J) using the Fabric Tie-Backs.

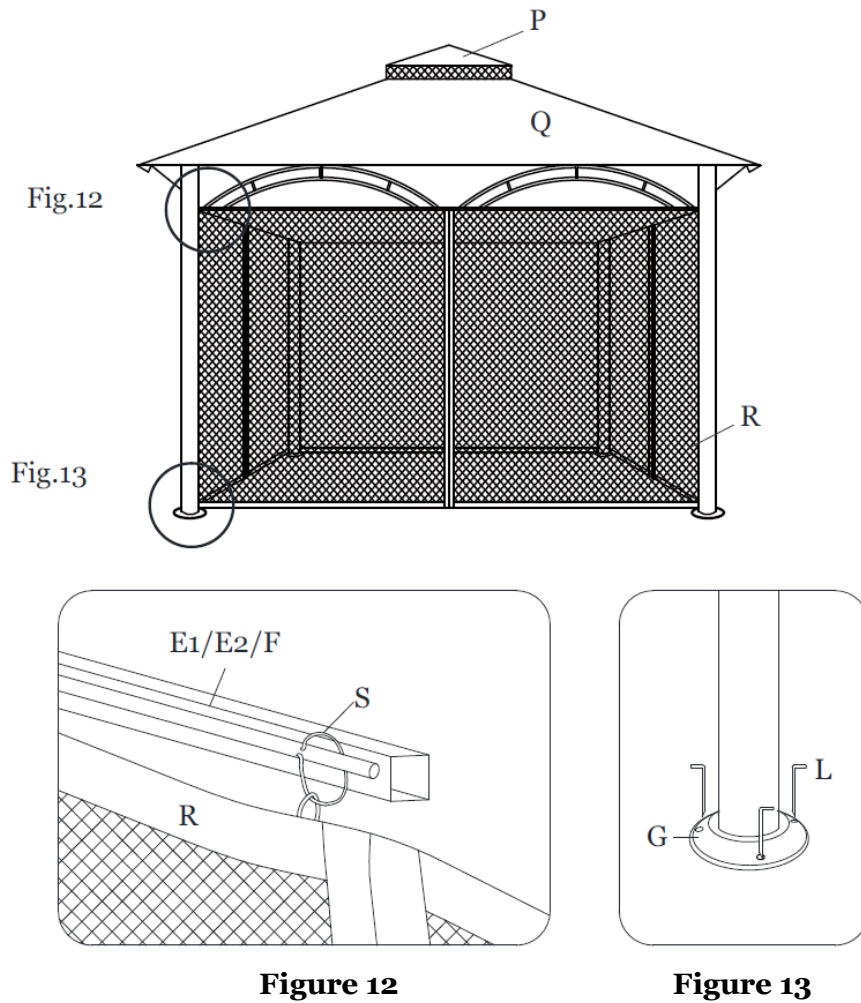

VI. Securing the Gazebo:

Step 1: Insert the Ground Stakes (L) into the holes of the Base Plate (G). See Figure 13.

Note: Gazebo Dimensions 9' x 11' are measured from roof canopy.

Note: Please see our video for additional assembly assistance:

<https://shadenshelters.com/9-x-11-lexington-gazebo>

Lexington Gazebo Accessories

Please visit <https://shadenshelters.com> to purchase

- Privacy Curtain
- Replacement Roof Canopy
- Replacement Mosquito Netting

Care & Maintenance

Maintain your gazebo by removing the canopies and storing out of the elements when not in use, or during hazardous weather conditions (wind, rain, snow, etc.).

Frame: Clean frames with a mild soap and warm water. Do not use abrasive materials, cleaners or bleach. Rinse with clean water and dry thoroughly.

Fabric: Canopy may be cleaned by hand with a mild solution of soap and water. Rinse thoroughly and allow to drip dry. Do not use bleach or solvents on fabrics.

Warranty

You must retain the original receipt to obtain warranty service.

What is covered?

Frame: Frame is warranted against rusting for 1-year

Finish: Frame Finish is warranted against peeling, cracking or blistering for 1-year if the product has not been scratched or abrade.

Fabric: Canopy are covered by a 1-year warranty against manufacturing defects.

What is not covered?

EXCLUSIONS: Gazebo use for commercial, contract, or other non-residential purposes, damage due to acts of nature, vandalism, misuse, or improper assembly are not covered. Discoloration or fading of the finish or fabrics as a result of chemicals or spills, pool water chemicals or salt water is not covered. Mildew of fabric is not covered. Corrosion and rusting of frames and hardware is not covered. If within the stated warranty period this product is found to be defective in material or workmanship, the purchaser must contact the manufacturer's customer service department. The manufacturer, at its option, will repair or replace the defective parts. Proof of purchase (dated register receipt) is required for warranty claims. It remains the customer's responsibility to pay for freight and packaging charges to and from the service center. Warranty is to the original purchaser and is non-transferable. Any replacement or warranted items will be in the original style and color, or similar style and color if the original is unavailable or has been discontinued.

Questions, problems, missing or damaged part? Before returning to the store call or email our Customer Service.

Customer Service Contact Information:

Hours: Monday - Friday 8:00 a.m. - 5:00 p.m. Central Time (CT)

Phone: 1-888-607-4417

Email: service@shadenshelters.com