



SEALING SOLUTIONS FOR TRACTORS



Today's agricultural operations provide multiple challenges to farmers in terms of precision farming, the maintenance of agricultural equipment and minimizing the impact on the environment. These challenges can be overcome by utilizing technological innovations with highly advanced farming equipment, maximizing efficiency and cleaner operation.

NAK offers a wide range of sealing solutions such as cassette seals, combi-seals and multiple lip configurations to withstand the intense exposure to dirt and other external contaminants.

For tractor manufacturers, NAK provides a wide range of seals for different applications, such as engine, transmission, wheel hub/axle, power steering cylinder, lift cylinder, and PTO.

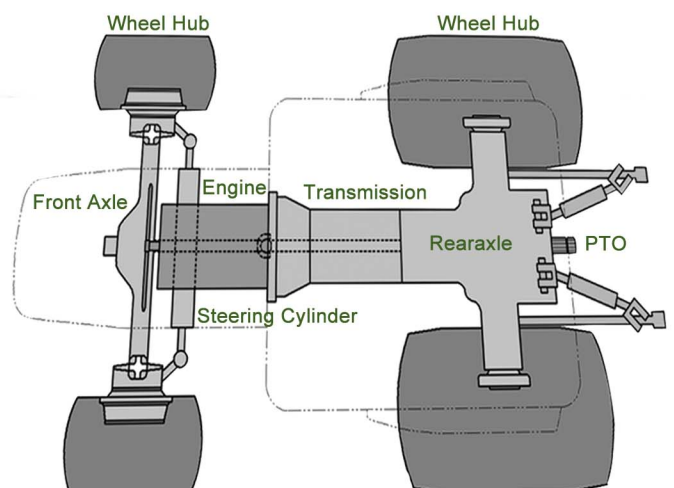



ENGINE SEALS

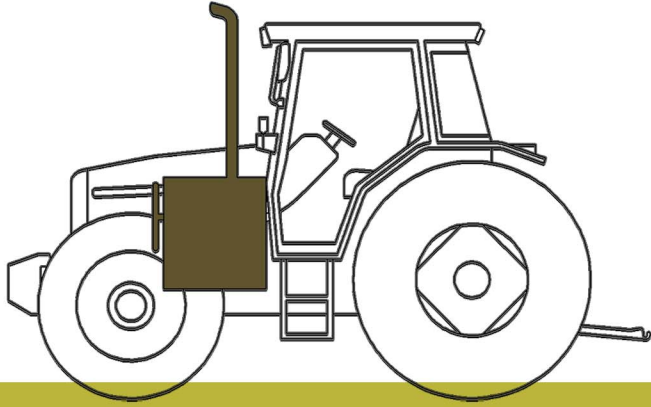

OIL SEAL PRODUCTS FOR ENGINE

Tractors are usually powered with large diesel engines that are especially good at providing high torque at low speeds.

NAK has a range of engine seals types and styles with improved high performance materials and excellent hydrodynamic helix design.



MATERIAL

For engine seals, NAK provides a wide range of materials including NBR, ACM, FKM and PTFE.

Among different materials, PTFE are the trend for future development as nowadays the engine is running at generating more heat and creating more friction. FKM is common used in valve stem seals. It has temperature resistance and good chemical properties.

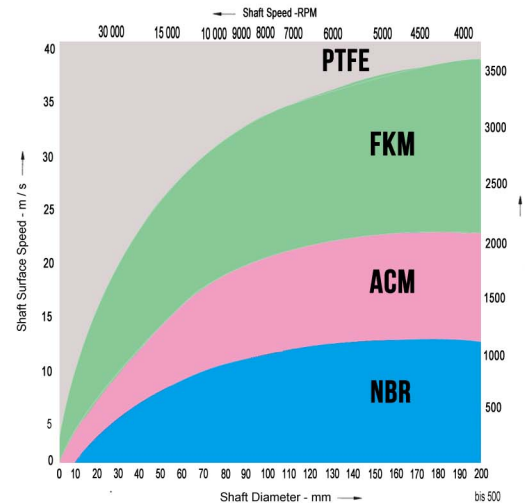

VSG 1	TC 10	PA 11	PA 8

More technical information and customization designs are available upon request. Please contact with us for more information.



TRANSMISSION SEALS



OIL SEAL PRODUCTS FOR TRANSMISSION

Automatic transmission is a transmission type that automatically changes the gears with regard to speed of the vehicle. The primary components of automatic transmission include planetary gear sets, hydraulic system, seals and gaskets, torque converter, governor, modulator and computer. The modern automatic transmission system comprises many components and devices that are designed to achieve all the sophisticated functions demanded by acute buyers. These components of transmission require higher stability and response.

MATERIAL

Transmission seals mainly use ACM, FKM, AEM and HNBR.

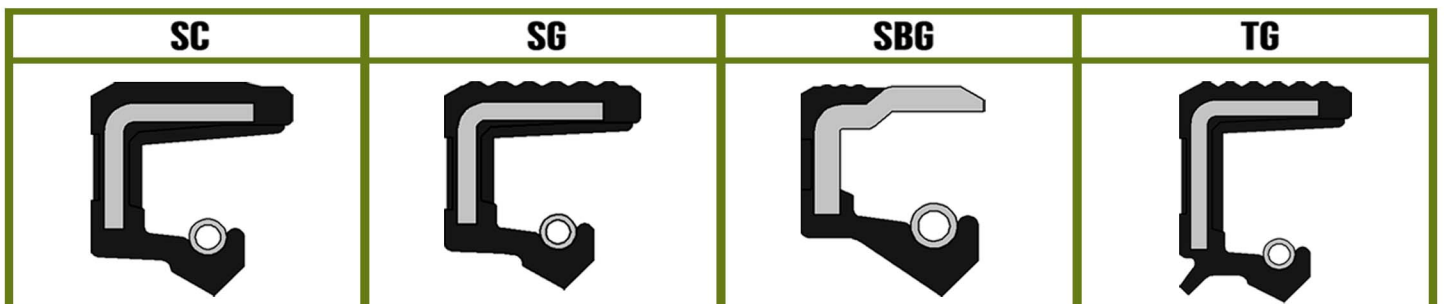
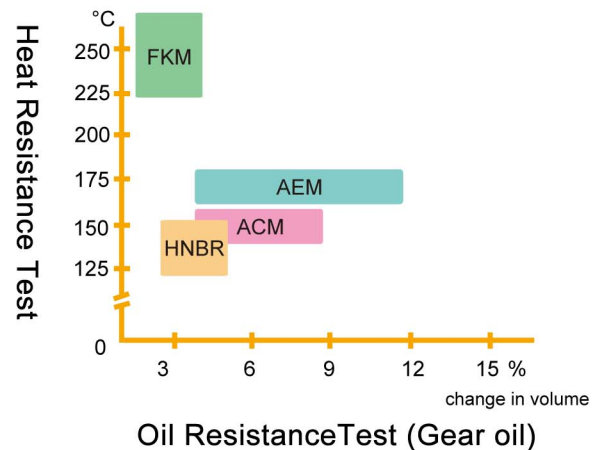

More technical information and customization designs are available upon request. Please contact with us for more information.



AXLE / WHEEL HUB SEALS

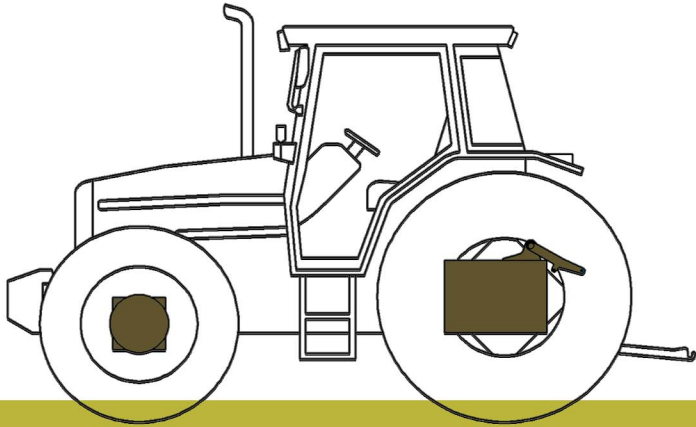

OIL SEAL PRODUCTS FOR AXLE

An axle is an integral component of the most practical wheeled vehicles. They serve to transmit driving torque to the wheel as well as to maintain optimum position relative to each other.

NAK provides a wide range of shaft seals for different axle applications focusing on the heavy contamination issue in these exposed locations with excluder lips and advanced elastomeric materials for various sizes and designs.

MATERIAL

Tractor axle / wheel hub seals mainly use NBR or HNBR.

OIL SEAL PRODUCTS FOR WHEEL HUB

A wheel hub unit is an integral part of the tractor wheel in providing support through the wheels and protection against dust contamination.

NAK provides a wide range of seals for tractor wheel hub applications focusing on the heavy contamination issue with advanced elastomeric materials with different sizes and designs.

A0	AP5
CRS34	ST16

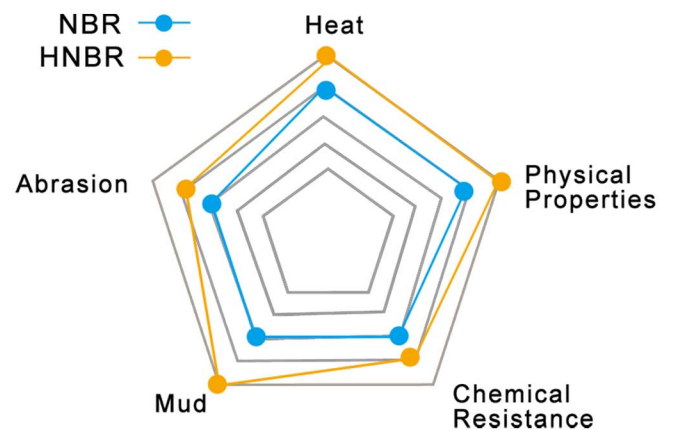

More technical information and customization designs are available upon request. Please contact with us for more information.



PTO SEALS

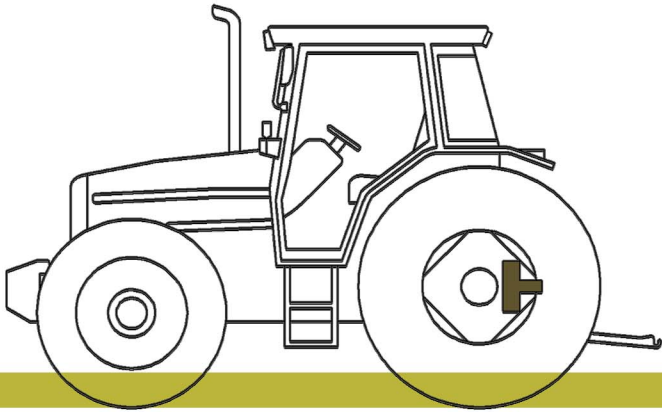

OIL SEAL PRODUCTS FOR PTO

PTO (Power take-off) is a feature most often found in agricultural and construction equipment. In tractors it involves the transfer of power from the powertrain to an implement or attachment through the drive shaft.

For PTO's NAK offers various seals in both standard and custom designs to suit a wide range of rigorous operating conditions.



MATERIAL

PTO seals mainly use NBR, HNBR and FKM.

TB	TC2
AP13	AJ1

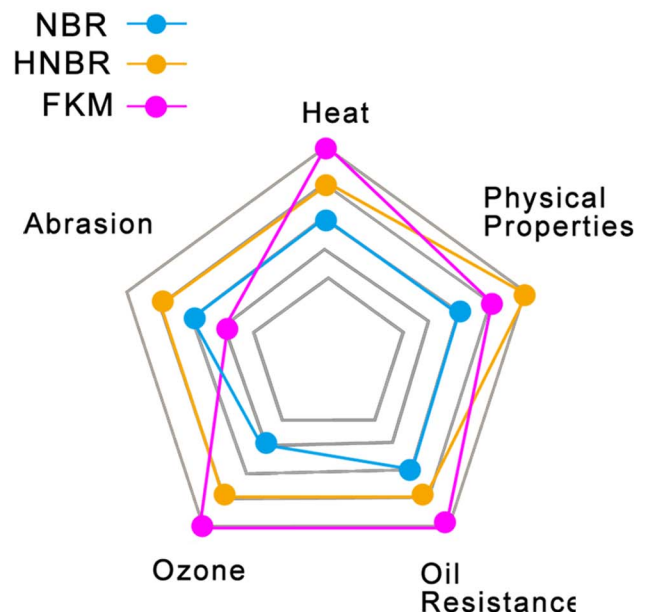

More technical information and customization designs are available upon request. Please contact with us for more information.



HYDRAULIC CYLINDER SEALS

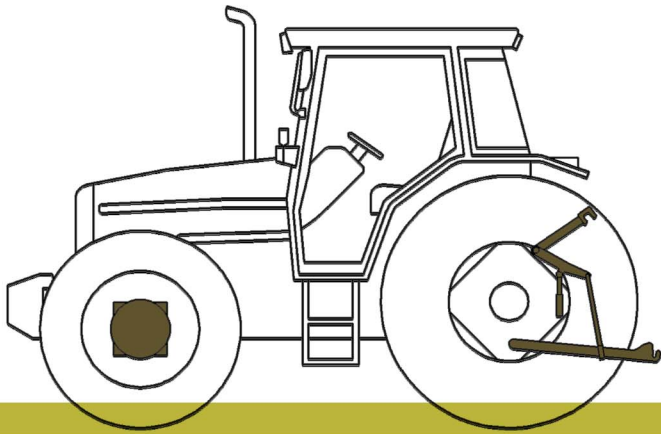

OIL SEAL PRODUCTS FOR LIFT CYLINDER

A lift cylinder is actually a linear hydraulic actuator that is used to give an unidirectional force through a unidirectional stroke. For tractors it's an important part that helps in handling different weight variations depending on the equipment model.



OIL SEAL PRODUCTS FOR STEERING CYLINDER

Power steering is the key part of the tractor steering system that helps in steer by augmenting the steering effort via an actuator and a hydraulic cylinder which is a part of a servo system. These systems have a direct mechanical connection between the steering wheel and the linkage that steers the wheels.



UOP	HPO	UIP2	WPM

More technical information and customization designs are available upon request. Please contact with us for more information.