



# PRODUCT INFORMATION

## NAK SEALING SOLUTIONS FOR PUMPS



# PUMP

A pump is a device for compressing, driving, raising, or reducing the pressure of a fluid, especially by means of a piston or a set of rotating impellers. Pumps can be classified into three major groups according to the method they use to move the fluid i.e.: direct lift, displacement, and gravity pumps.

Pumps operate by some mechanisms which are typically a reciprocating or rotary motion, and consume energy to perform mechanical work by moving the fluid to various positions. Pumps operate via many energy sources, including manual operation, electricity, engines, or wind power, come in many sizes, from microscopic for use in medical applications to large industrial pumps.

## Pump Specifications

Pumps are used for a variety of applications and they are designed to satisfy various customer requirements for higher pressure, quiet operation, long life, and a full range of options and features.



NAK provides customized designs and dimensions with different a set of quality materials in NBR, HNBR, FKM and PTFE. According to the different Size, Temperature, Application, Media, Pressure, Speed and installation process for various operating conditions, we provide sealing solutions for pumps which include seals, rings, gaskets and other elastomeric compounds.

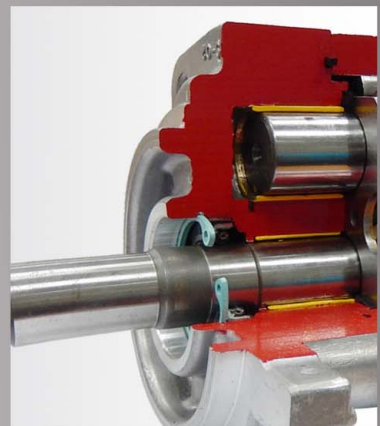



# SEALING SOLUTIONS FOR HYDRAULIC PUMP

Hydraulic pumps are capable of pushing large amounts of oil through hydraulic cylinders or hydraulic motors. Hydraulic pumps operate according to the displacement principle. Positive-displacement and non-positive-displacement is what hydraulic pumps can be classified into, though a majority of the hydraulic systems utilize positive-displacement. The slippage in the positive-displacement pump is minor compared to volumetric output flow of the pump. This involves the existence of mechanically sealed chambers in the pump. Through these chambers, fluid is transported from the inlet (suction port) of the pump to the outlet (pressure port). The sealed chambers ensure that there is no direct connection between the two ports of the pump. As a result, these pumps are very suitable to operate at high system pressures and are ideal for hydraulics.

Hydraulic pumps include Piston pumps (Axial, Radial), Gear pumps (External, Internal, Gear ring, Screw) & Vane pumps (Single chamber, Double chamber). They are used for agriculture, water treatment, chemical industry, construction, refinery, food industry and various industrial applications.

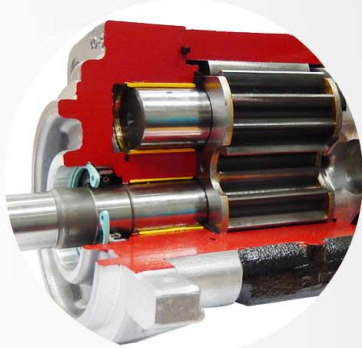

Gear pump



Vane pump

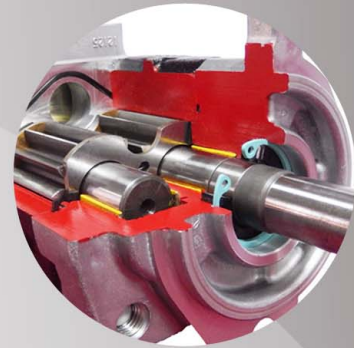

Piston pump

## Materials

### ⚙️ NBR

- Maintain stability under various fluids and additives
- Resistance to oil and ozone
- Resistance to wear
- Low and high temperature capabilities
- Mechanical properties e.g. tensile strength
- Vulcanized by either sulfur or Hydrogen peroxide



### ⚙️ FKM

- Excellent chemical resistance
- Low gas permeability
- Good temperature resistance
- Good weather resistance
- Excellent resistance to oil (especially polar oil) and solvent



# SEALING SOLUTIONS FOR HYDRAULIC PUMP

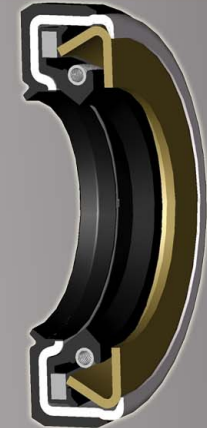
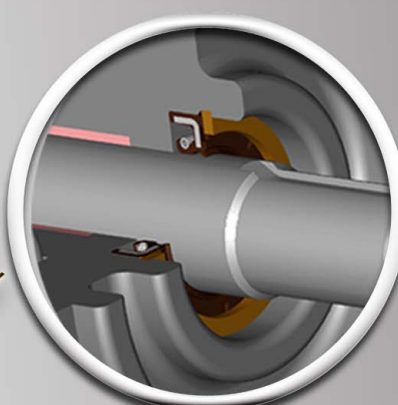
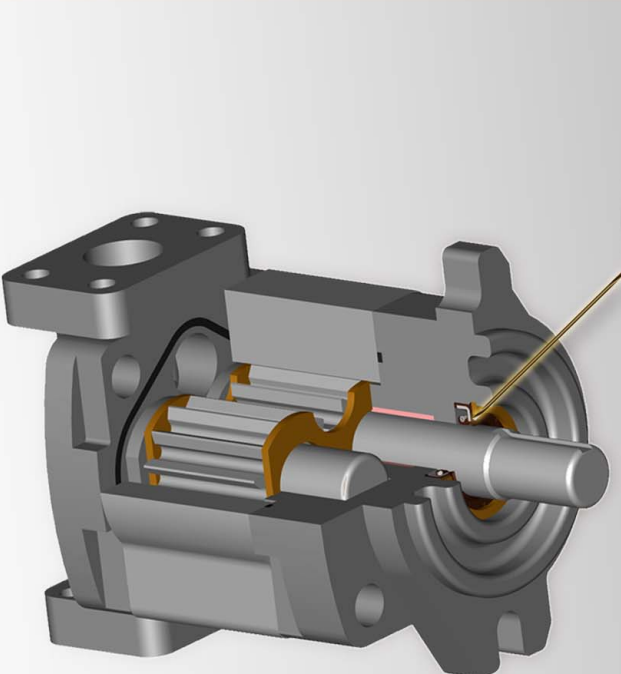

Probably the simplest and most commonly used today, they are easy maintain and are economical for a long term condition. Two basic types exist; the internal gear and external gear in which both are of the positive or fixed displacement pump group. External pumps use two external gears that mesh and push oil around the outside of the gear. Pressures up to 250 bar are common, but cast iron designs increase this to 320 bar. Straight cut and helical spur gears give lower noise performance.

## P-V CURVE OF PRESSURE SEAL

NAK provides different kinds of monitored tests in our dynamic test laboratory. As per the pressure seal, NAK provides tests for medium and high-pressure applications up to 140 bar. By researching and developing under simulated environment, we are able to offer appropriate recommendations and sealing solutions that ensure maximum performance.





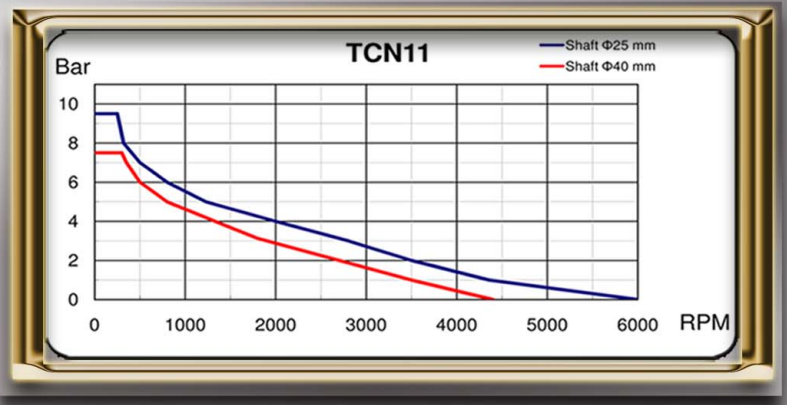



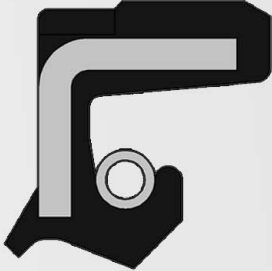
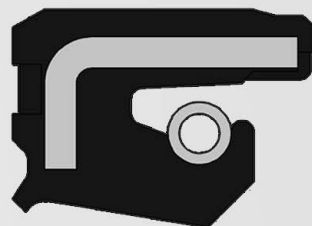
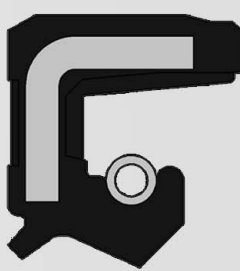
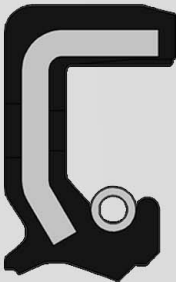

Seal Type	Avg. Pressure (bar)	Max. Pressure (bar)	Max. Velocity (m/s)	Max. PV (bar*m/s)
TCN1/TCN11	3.5	7	9	10
TDN1	7	10	9	23

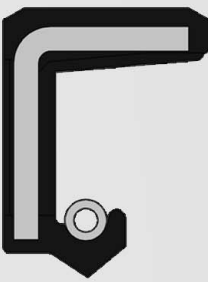
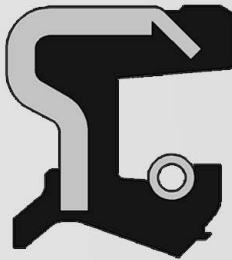
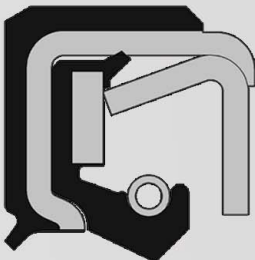
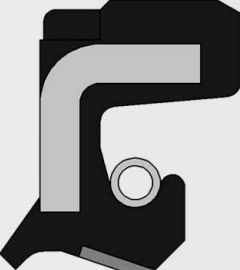
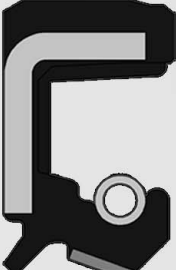
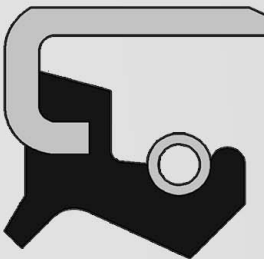

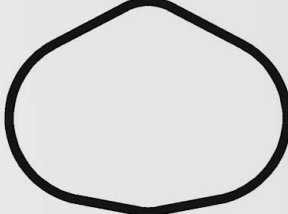

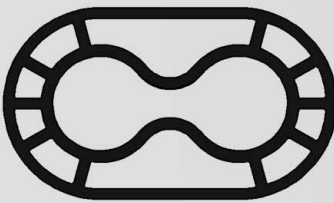
# NAK SEALING SOLUTIONS FOR HYDRAULIC PUMPS SEALS

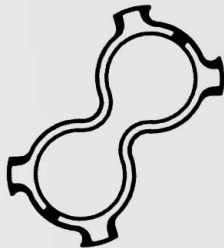
TCN	TCN7	TCN1	TCN15
			
TCN2	SCN11	TZN22	TDN1
			
TCN-PL	TCN2-PL	TEB	TEC
			
R3	R28	R6	R16
			
R17	R57		
			

More technical information and customization designs are available upon request. Please contact with us for more information.

# SEALING SOLUTIONS FOR VACUUM PUMP

A vacuum pump is a device that removes gas molecules from a sealed volume in order to leave behind a partial vacuum. Sometimes it removes gas from an area, other times a vacuum pump will remove water from one area to another. Vacuum pumps are used in an industrial setting to produce vacuum tubes and to process semiconductors. They can also produce a vacuum that can then be used to power a piece of equipment.

Vacuum pumps are found in many applications. These include, among others, vacuum packaging of food evacuation and environment-friendly charging of refrigerators and air conditioners production of ultrapure high-strength metals evacuation of lamps and picture tubes manufacture of flat-panel displays.

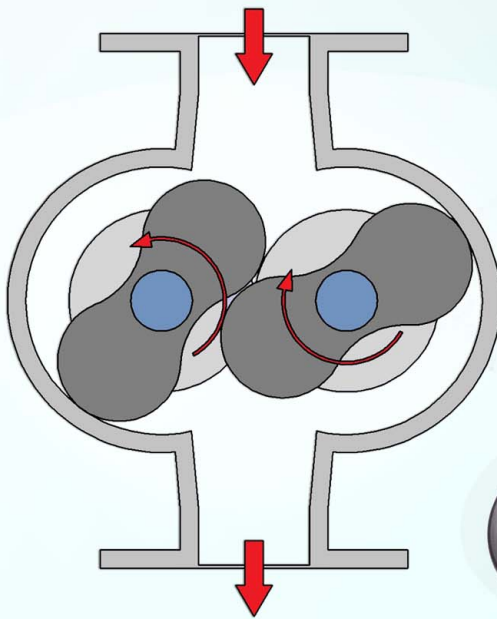





## Material

### PTFE

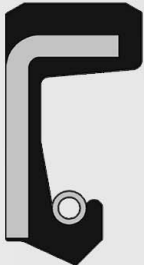
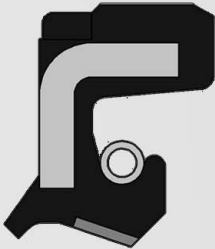
- Perfect flex fatigue characteristics
- Excellent temperature capability
- Resistant to tear, severe crack and abrasion
- Outstanding toughness and stiffness
- Resistant to water and other liquids
- Controllable product quality
- Recyclable to be used in different products

# NAK SEALING SOLUTIONS FOR VACUUM PUMPS SEALS

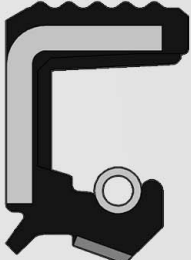
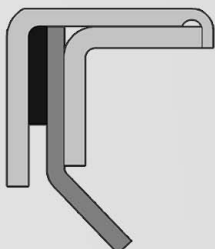
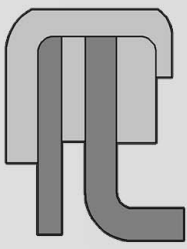
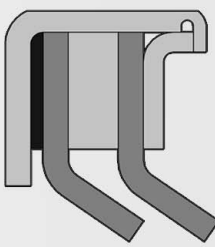
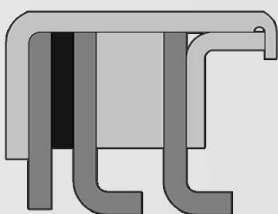
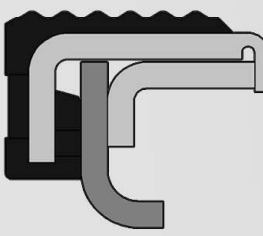
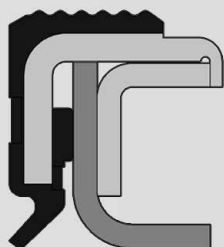
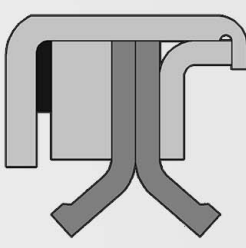
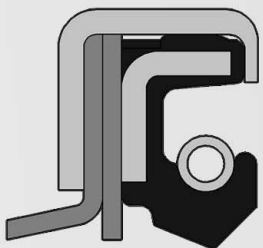
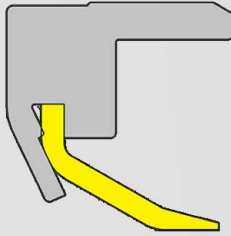
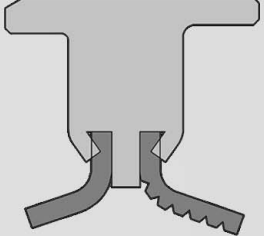
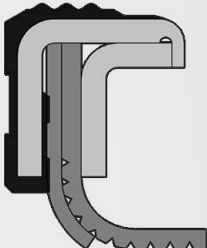
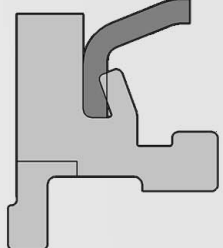
SCN	TCN-PL	TCN1-PL	SCN1-PL
			
TCN2-PL	TGN2-PL	PA1	PA2
			
PA3	PA4	PA5	PA6
			
PA7	PA9	PA14	PA15
			
PA17	OPA1		
			

More technical information and customization designs are available upon request. Please contact with us for more information.

# SEALING SOLUTIONS FOR SUBMERSIBLE PUMP

Submersible pumps are a particular type of a centrifugal pump designed to function with the pump and the motor completely submerged in the process media. The motor will of course be sealed in a way that prevents any ingress of the media from seeping into the motor casing and causing the motor to fail. Many submersible pumps operate under the principle of Electric Submersible Pumping (ESP).







Submersible pumps can feature a single stage or multiple stages that can be connected to various types of pipes, flexible hoses or wires, depending on the job and the liquid being pumped.

Submersible pumps are suitable for most applications, such as drinking, irrigation, and various industrial applications.

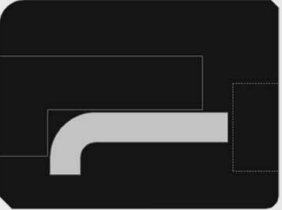
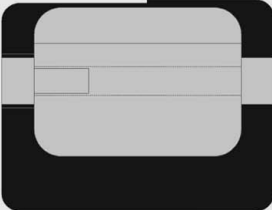

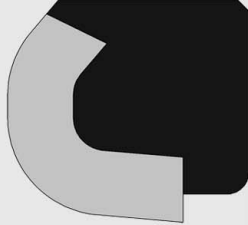

# NAK SEALING SOLUTIONS FOR SUBMERSIBLE PUMPS SEALS

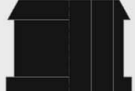
VC3	VC27	VC28	VC31
			
VC58	VC59	VM10	WR8
			
BUSHING			
 			

More technical information and customization designs are available upon request. Please contact with us for more information.



Factory



Service office & warehouse



## Taiwan (NAK Headquarters)

**NAK SEALING TECHNOLOGIES CORPORATION**  
 No.336, Industrial Road, Nankang Industrial Zone, Nantou  
 City 54065, Taiwan  
 TEL : 886-49-2255011  
 FAX : 886-49-2250035  
 E-mail : service@mail.nak.com.tw  
 www.nak.com.tw



## China

**KUNSHAN MAOSHUN SEALING PRODUCTS INDUSTRIAL CO., LTD.**  
 no. 510, Hengchangjing Road, Zhoushi Town,  
 Kunshan City, Jiangsu Prov., China 215337  
 TEL : 86-512-57661139  
 FAX : 86-512-57665827; 86-512-57664409  
 E-mail : sales@nak.com.cn  
 www.ksnak.com



## Iran

**KISH NAK OIL SEAL MFG. CO., LTD.**  
 No.67, Eshghyar St. Khorramshahr Ave.,  
 Tehran 15339, Iran  
 TEL : 98-21-88761965 / 88749015 / 88749016  
 FAX : 98-21-88741319  
 E-mail : kishnak@pol.ir



## Thailand

**NAK SEALING PRODUCTS(THAILAND) CO., LTD.**  
 120/36 Moo 12 Soi 21/2 Kingkaew-Bangplee Road, Tumbul  
 Rachatewa, Ampur Bangplee Samutprakarn 10540, Thailand  
 TEL : 66-2-750-1988  
 FAX : 66-2-750-1868  
 E-mail : sales@mail.thainak.com



## Russia

**NAK INTERNATIONAL LTD.**  
 House 8, Factory Street, Reutov, Moscow Region,  
 143960, Russia  
 TEL : 7-495-545-94-00  
 FAX : 7-495-646-79-29  
 E-mail : info@naksealing.ru  
 www.naksealing.ru



## India

**NAK SEALING TECHNOLOGIES (INDIA) PRIVATE LIMITED**  
 P-1, Phase II, Dr.Vikram Sarabhai Industrial Estate,  
 Thiruvanniyur, Chennai - 600 041, Tamilnadu, India.  
 TEL : 91-44-64586657; 91-9551250445  
 E-mail : marketing@nakindia.com



## Brazil

**NAK DO BRASIL INDUSTRIA E COMERCIO DE COMPONENTES DE VEDACAO LTDA**  
 Rua Soldado Benedito Eliseo Dos Santos, NRO 10 CEP  
 02177-020, Sao Paulo S.P, Brazil  
 TEL : 55-11-3807-3001  
 FAX : 55-11-3807-3002  
 E-mail : nakbrasil@nakbrasil.com.br  
 comercial@nakbrasil.com.br



## Australia

**NAK TOTAL SEALING SOLUTIONS AUSTRALIA**  
 Unit 1-17 Buttonwood Place,  
 Willawong QLD 4110, Australia  
 TEL : 61-7-3272-0266  
 FAX : 61-2-6674-2516  
 E-mail : sales@sealingtechnologies.net  
 www.naksealingtechnologies.com



### Disclaimer

1. NAK products are not intended to be used, installed or applied in or on any aerospace related instruments and/or equipment. Any such use, installation, or application is prohibited and shall void all warranties.
2. NAK disclaims any and all express or implied warranties if the products :
  - 2.1 are modified or tampered with;
  - 2.2 are misused, abused or misapplied;
  - 2.3 are used in a critical environment or specific equipment without NAK's prior written consent;
  - 2.4 are not used in accordance with the printed user instruction materials; or
  - 2.5 are damaged due to natural deterioration, decomposition or transformation of chemical structure.
3. The products may be applied in critical environment or specific equipment only upon official confirmation of the sample by NAK's technical personnel and the passing of tests conducted by buyer.