

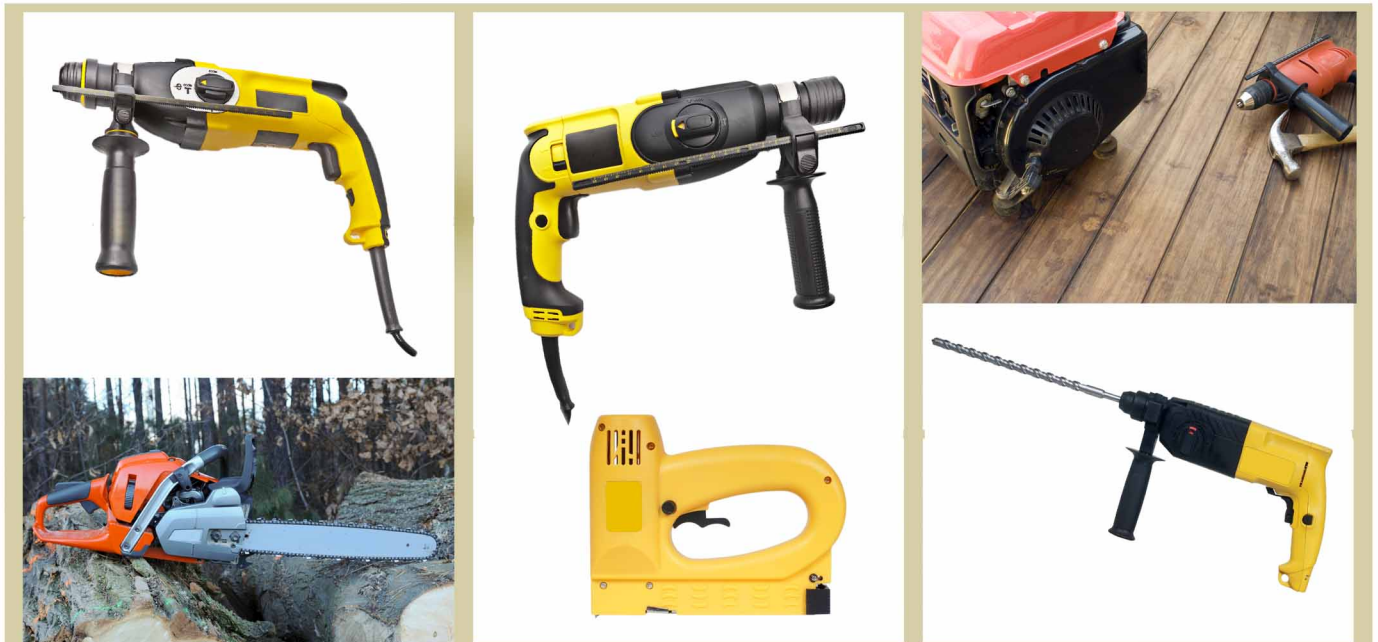

# Introduction

Power tools are kinds of equipment actuated by additional power source and mechanism other than the solely manual labor used with hand tools. According to the survey, the global demand of power tools is getting rising year by year. Power tools are used to cut quickly into concrete, stone, cement block, or brick which are used in a wide range of commercial or industrial applications. In addition, they are also used broadly in consumer-related settings, i.e., in do-it-yourself and home remodeling activities for drilling, grinding, shaping and more.

Power tool can be generated by various sources, which are mainly sorted into electric motors, rechargeable batteries, gasoline engines, and compressed air motors. They may be corded or cordless, and may involve with variety of motions in the moving parts including side-to-side, up and down, and other complicated combination of movements.



# Specification



NAK sealing solutions for industrial power tools include rotary seals and O-rings.

Rotary seals are the sealing elements that have specific interference between the sealing lip and the shaft. The seal lip provides sealing function to retain oil from leaking to the outside while prevents contaminants from entering to the system. When the seal lip is contacting with the shaft, a thin lubricant film is formed along with the seal lip contact area which could reduce friction and wear between the seal lip and the shaft. Moreover, the thin film could be a nature barrier between the air side and the oil side of the seal. Customized design for both single lip and dual-lip seal are available.

O-rings are kind of sealing ring to be installed in grooves. It can be used to seal oil, water, air, gas and other fluids, for both static and dynamic applications.



Additional elastomeric compounds to fit different applications are available upon request. Please contact us for more information.

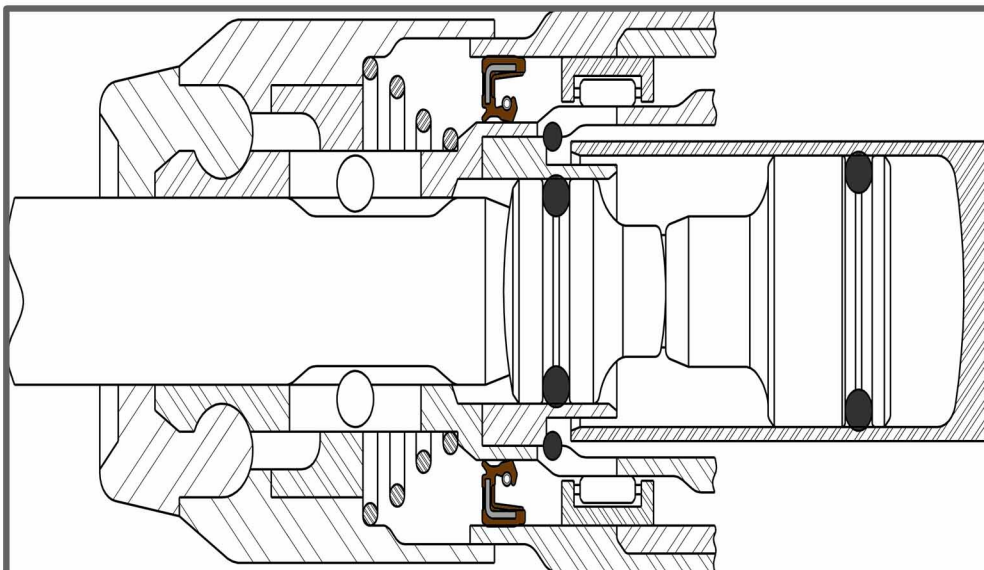
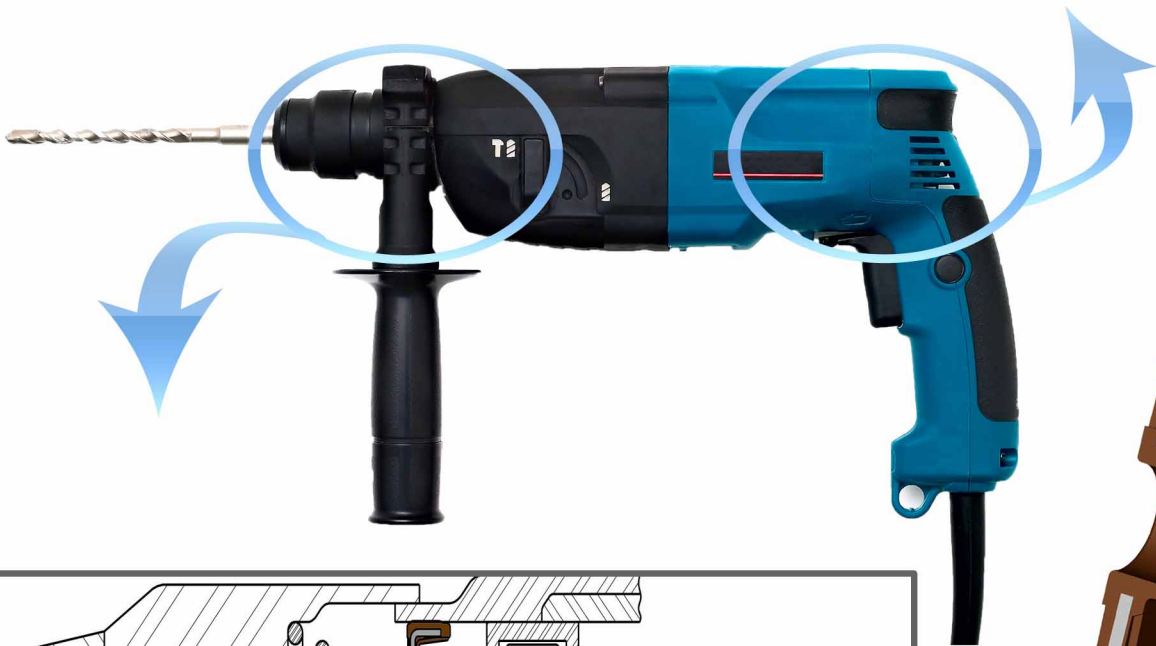
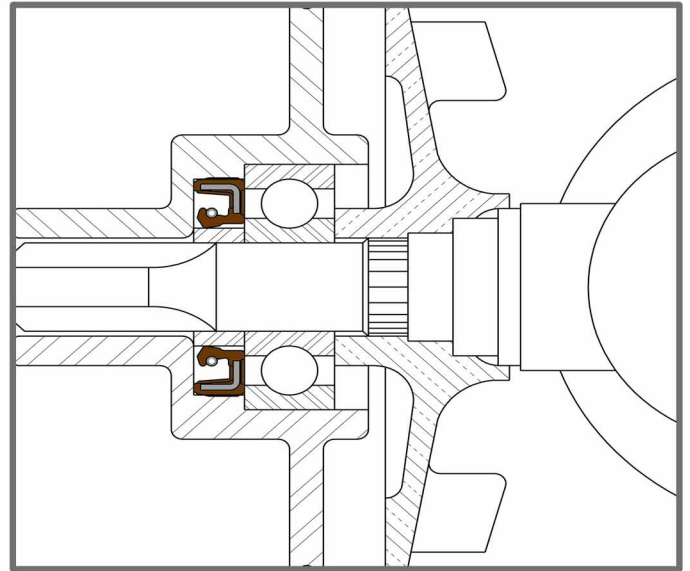

# Applications

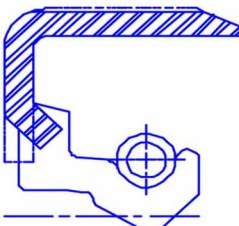
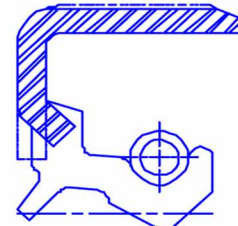
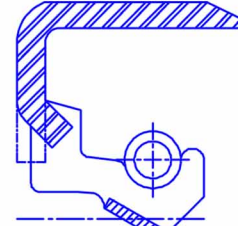
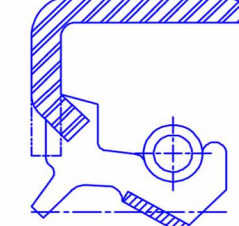
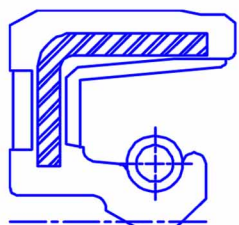
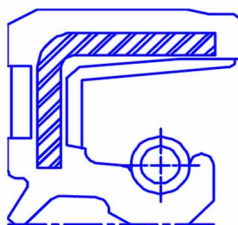
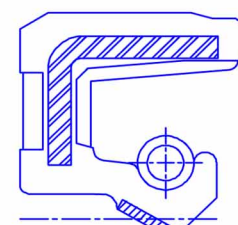
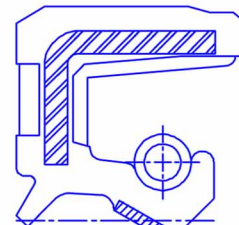
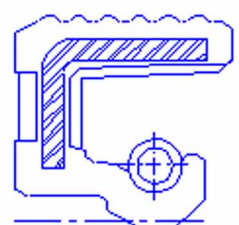
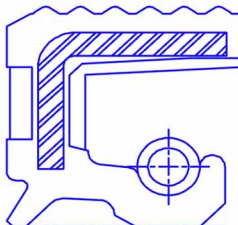
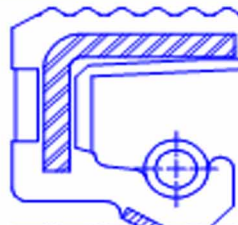
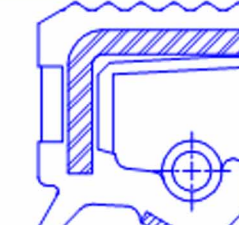
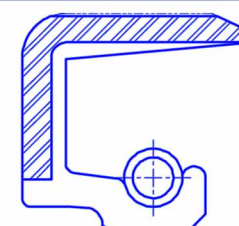
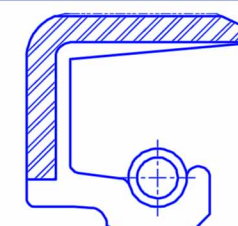
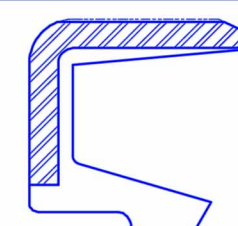
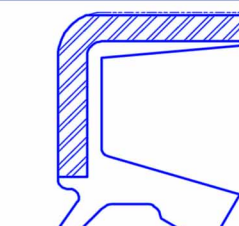
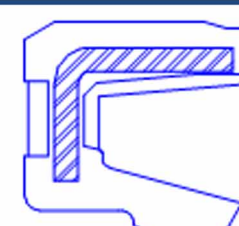
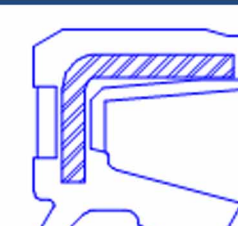
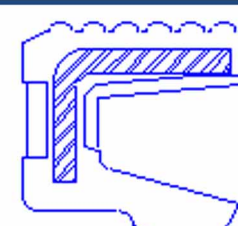

# NAK Sealing Solutions for Industrial Power Tools

|   |   |  |   |
|---|---|--|---|
| <b>SB</b>   | <b>TB</b>   | <b>SB-PL</b>   | <b>TB-PL</b>  |
|    |    |    |    |
| <b>SC</b>   | <b>TC</b>   | <b>SC-PL</b>   | <b>TC-PL</b>  |
|   |   |   |   |
| <b>SG</b>   | <b>TG</b>   | <b>SG-PL</b>   | <b>TG-PL</b>  |
|  |  |  |  |
| <b>SM</b>   | <b>TM</b>   | <b>VM</b>  | <b>KM</b>   |
|  |  |  |  |
| <b>VC</b>   | <b>KC</b>   | <b>VG</b>  | <b>KG</b>   |
|  |  |  |  |



## Subsidiary map

### Existing subsidiaries worldwide

● Factory

● Service office & warehouse



#### Taiwan (NAK Headquarters)

**NAK SEALING TECHNOLOGIES CORPORATION**  
No.336, Industrial Road, Nankang Industrial Zone, Nantou  
City 54065, Taiwan  
TEL : 886-49-2255011  
FAX : 886-49-2250035  
E-mail : service@mail.nak.com.tw  
www.nak.com.tw



#### China

**KUNSHAN MAOSHUN SEALING PRODUCTS INDUSTRIAL CO., LTD.**  
No.271, Xingpu Road, Zhoushi Town, Kun Shan City,  
Jiangsu Prov., China 215337  
TEL : 86-512-57666240; 86-512-57665788  
FAX : 86-512-57665827; 86-512-57664409  
E-mail : sales@nak.com.cn  
www.ksnak.com



#### Iran

**KISH NAK OIL SEAL MFG. CO., LTD.**  
No.67, Eshghyar St. Khorramshahr Ave.,  
Tehran 15339, Iran  
TEL : 98-21-88761965  
FAX : 98-21-88741319  
E-mail : kishnak@parsonline.net



#### Thailand

**NAK SEALING PRODUCTS(THAILAND) CO., LTD.**  
120/36 Moo 12 Soi 21/2 Kingkaew-Bangplee Road, Tumbul  
Rachatewa, Ampur Bangplee Samutprakarn 10540, Thailand  
TEL : 66-2-750-1988  
FAX : 66-2-750-1868  
E-mail : sales@mail.thainak.com



#### Russia

**NAK INTERNATIONAL LTD.**  
Russia, Postal Index 143956, Moscow Region, Balashiha,  
Mikroraion Nikolsko-Arhangelskiy, Vishnyakovskoe Shosse,  
56, "NAK INTERNATIONAL LTD."  
TEL : 7-495-545-94-00  
FAX : 7-495-646-79-29  
E-mail : info@naksealing.ru  
www.naksealing.ru



#### India

**NAK SEALING TECHNOLOGIES (INDIA) PRIVATE LIMITED**  
P-1, Phase II, Dr.Vikram Sarabhai Industrial Estate,  
Thiruvanniyur, Chennai - 600 041, Tamilnadu, India.  
TEL : 91-44-64586657; 91-44-64586661  
FAX : 91-44-24540254  
E-mail : marketing@nakindia.com



#### Brazil

**NAK DO BRASIL INDUSTRIA E COMERCIO DE COMPONENTES DE VEDACAO LTDA**  
Rua Soldado Benedito Eliseo Dos Santos, NRO 10 CEP  
02177-020, Sao Paulo S.P, Brazil  
TEL : 55-11-3807-3001  
FAX : 55-11-3807-3002  
E-mail : nakbrasil@nakbrasil.com.br  
comercial@nakbrasil.com.br



#### Australia

**NAK TOTAL SEALING SOLUTIONS AUSTRALIA**  
Unit 1-17 Buttonwood Place,  
Willawong QLD 4110, Australia  
TEL : 61-7-3272-0266  
FAX : 61-2-6674-2516  
E-mail : sales@sealingtechnologies.net  
www.naksealingtechnologies.com



#### Disclaimer

1. NAK products are not intended to be used, installed or applied in or on any aerospace related instruments and/or equipment. Any such use, installation, or application is prohibited and shall void all warranties.
2. NAK disclaims any and all express or implied warranties if the products :
  - 2.1 are modified or tampered with;
  - 2.2 are misused, abused or misapplied;
  - 2.3 are used in a critical environment or specific equipment without NAK's prior written consent;
  - 2.4 are not used in accordance with the printed user instruction materials; or
  - 2.5 are damaged due to natural deterioration, decomposition or transformation of chemical structure.
3. The products may be applied in critical environment or specific equipment only upon official confirmation of the sample by NAK's technical personnel and the passing of tests conducted by buyer.