

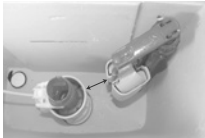

TROUBLESHOOTER

PROBLEM	CAUSE	SOLUTIONS
THE CISTERN IS NOT FILLING	<ul style="list-style-type: none"> The inlet valve is shut off and does not open 	<ul style="list-style-type: none"> Turn on water supply Check all moving components move up and down freely. If not undip the rod from the float (photos 1 and 2). Reclip it in correct way (photos 3 and 4).
LEAK FROM THE FLUSHING INTERNAL VALVE OVERFLOW	<ul style="list-style-type: none"> The high level of the float basin is higher than the top level of the overflow 	<ul style="list-style-type: none"> Flush the cistern. Turn the water supply off. Undip the adjustment rod from the float (photos 1 and 2). Push on the float in order to make it go down. Clip the adjustment rod on the float in the correct way (photos 3 and 4). Check that the water level is right (scheme 5).
THE FULL FLUSH OR THE HALF FLUSH IS NOT SUFFICIENT	<ul style="list-style-type: none"> The water height is too low in the tank 	<ul style="list-style-type: none"> Flush the cistern. Turn off water supply. Undip the adjustment rod from the float (photos 1 and 2) Raise the level of the float basin on the body Re clip the adjustment rod on the float in the correct way (photos 3 and 4). Check the flush is sufficient. Undip the red adjustment rod from the float (photos 1 and 2). Reclip it in correct way (photos 3 and 4). Put the filter restrictor in accordance with the instructions (Scheme 6). Wash the diaphragm in conformity with the instructions described on the back. Before turning water on, ensure that one cold water tap is open so that dirt and loose particles in the pipe work are flushed through the tap (Scheme 7). Wash the filter restrictor (photo 10) in conformity with the instructions described on the back. Wash the diaphragm (Scheme 7) in conformity with the instructions described on the back. Call after self service number (Helpline Number). Put the filter restrictor in accordance with the instructions (Scheme 6). Put the filter restrictor in accordance with the instructions (Scheme 6). Wash the diaphragm in conformity with the instructions described on the back (Scheme 7). Before turning water on, ensure that one cold water tap is open so that dirt and loose particles in the pipe work are flushed through the tap.
THE INLET VALVE DOES NOT SHUT OFF OR SHUTS OFF VERY SLOWLY (At the installation)	<ul style="list-style-type: none"> The float is completely outside the float basin. 	<ul style="list-style-type: none"> Put the filter restrictor in accordance with the instructions (Scheme 6). Wash the diaphragm in conformity with the instructions described on the back. Before turning water on, ensure that one cold water tap is open so that dirt and loose particles in the pipe work are flushed through the tap (Scheme 7). Wash the filter restrictor (photo 10) in conformity with the instructions described on the back. Wash the diaphragm (Scheme 7) in conformity with the instructions described on the back. Call after self service number (Helpline Number). Put the filter restrictor in accordance with the instructions (Scheme 6). Put the filter restrictor in accordance with the instructions (Scheme 6). Wash the diaphragm in conformity with the instructions described on the back (Scheme 7). Before turning water on, ensure that one cold water tap is open so that dirt and loose particles in the pipe work are flushed through the tap.
THE INLET VALVE DOES NOT SHUT OFF OR SHUTS OFF VERY SLOWLY (after a few months of using)	<ul style="list-style-type: none"> The diaphragm has some debris because the filter is missing. The diaphragm has some debris because the dirt and loose particles in the pipe work have not been flushed through the tap before having turned the water on (the filter has well been assembled on the valve). The filter restrictor has some debris. The diaphragm has some debris. The diaphragm is damaged. The flow restrictor has not been fitted in accordance with the instructions. 	<ul style="list-style-type: none"> Put the filter restrictor in accordance with the instructions (Scheme 6). Wash the diaphragm in conformity with the instructions described on the back (Scheme 7). Before turning water on, ensure that one cold water tap is open so that dirt and loose particles in the pipe work are flushed through the tap. Put the filter restrictor in accordance with the instructions (Scheme 6). Wash the diaphragm in conformity with the instructions described on the back (Scheme 7). Before turning water on, ensure that one cold water tap is open so that dirt and loose particles in the pipe work are flushed through the tap.
THE CISTERN IF FILLING VERY SLOWLY (at the installation)	<ul style="list-style-type: none"> The diaphragm has some debris because the filter restrictor is missing. The diaphragm has some debris because the dirt and loose particles in the pipe work have not been flushed through the tap before having turned water on (the filter has been assembled on the valve). 	<ul style="list-style-type: none"> Put the filter restrictor in accordance with the instructions (Scheme 6). Wash the diaphragm in conformity with the instructions described on the back (Scheme 7). Before turning water on, ensure that one cold water tap is open so that dirt and loose particles in the pipe work are flushed through the tap.
THE CISTERN IS NOT FILLING OR IS FILLING VERY SLOWLY (After a few months of using)	<ul style="list-style-type: none"> The diaphragm has some debris The diaphragm is damaged 	<ul style="list-style-type: none"> Wash the diaphragm (Scheme 7) in conformity with the instructions described on the back. Call after self service number (Helpline number).
THE CISTERN IS FILLING TOO QUICKLY	<ul style="list-style-type: none"> The filter restrictor has not been fitted in accordance the instructions 	<ul style="list-style-type: none"> Put the filter restrictor in accordance with the instructions (Scheme 6).
LEAK FROM THE BACK NUT	<ul style="list-style-type: none"> The back nut is not tight enough The rubber washer is missing on the inlet valve The rubber washer is damaged 	<ul style="list-style-type: none"> Re tighten the back nut (photo 8). Assemble the rubber washer on the valve (Scheme 9). Call after service number (Helpline number).

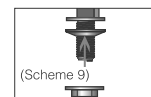
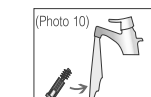
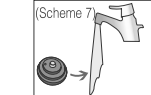
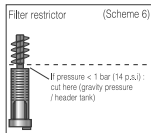
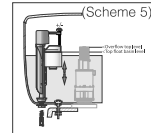
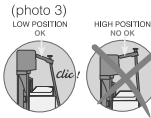

Watch our installation video

A: PRE-INSTALLATION

1. Turn off water supply to cistern lid.
2. Before emptying the cistern of water, mark the water level inside the cistern and empty the cistern of water.
3. Disconnect water supply from inlet valve and remove old flush valve.

For 2" outlet hole use thick base seal washer
For 1 1/2" outlet hole use thin base seal washer

B: INSTALLATION



Lift up the flush valve mechanism and place the float on the body.

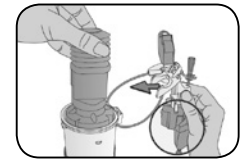

Place the valve with sealing washer on the inside of the cistern and secure with back nut.

ATTACH THE CISTERN

Place the base seal over threaded section and feed through bottom of cistern. Secure hand-tight plus half a turn using back-nut supplied (using a suitable spanner). Shown below are bolted and plated kit assemblies for close coupled WC pans and cisterns.

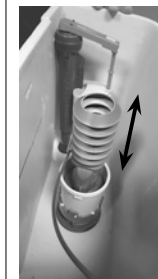
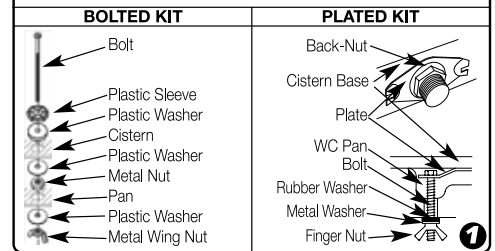

Set the height of the internal overflow 20mm min. above the water line.



www.wirquin.co.uk

Wirquin Ltd - Unit 3, Alpha Court, Capitol Park,
Thorne, DN8 5TZ - UK
T: +44(0) 333 222 4488 | Email: sales@wirquin.co.uk



JOLLYFILL TELESCOPIC BOTTOM ENTRY INLET VALVE INSTRUCTIONS



Attach button
It will fit cistern holes $\varnothing 14$ to $\varnothing 46$.

Then attach the cable.



Set float to adjust flush volumes by turning the red rod to move the float up (for less water) and down (to flush more water).

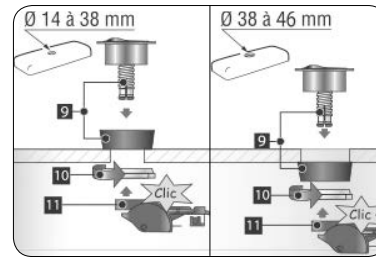

TROUBLE SHOOTING

Observation	Problems	Solution
Water is leaking back into the pan	The cable is obstructed	Pick up the cistern lid slightly and push button to check that the flush valve is moving up and down and not obstructed by the inlet valve or touching the cistern wall or kinked or twisted cable
	The water level in the cistern is above the internal overflow.	Check that the overflow is set 20mm above the waterline marked on the cistern.
	Seal not sitting flat on the valve base.	Check the seal is clean from debris. Take off and clean then refit.
Not flushing	Button is not working.	Locate the button and push with a click into the cable base.
		Make sure the cable is free and not kinked.

JOLLYFILL TELESCOPIC BOTTOM ENTRY INLET VALVE

A : PRE-INSTALLATION

- 1 Turn off water supply to cistern and remove cistern lid.
- 2 Flush the cistern and remove any loose dirt from inside the tank.
- 3 Disconnect and remove the existing inlet valve.

B : INSTALLATION

- 1 Insert correct filter restrictor into threaded tail.

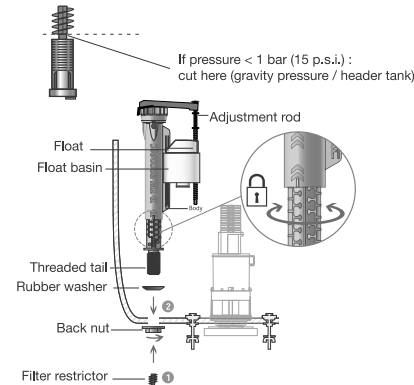

- 2 Fit the filling valve. Ensure that the valve does not obstruct the flush mechanism. Do not overtighten the back nut

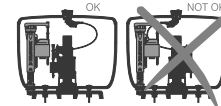

- 3 Important for new installations : before turning water on, ensure that one cold water tap is open so that dirt and loose particles in the pipe work are flushed through the tap (we also recommend to flush through the water supply pipe to the cistern before connection is made.

- 4 Connect water supply.
- 5 Turn on water supply. Allow the cistern to fill,
- A Adjust the water level,

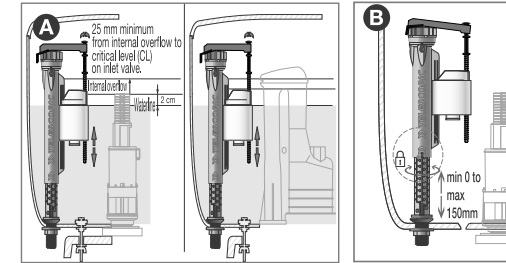

- B If the water level is not correct, turn off water supply. Adjust the water level by : Turning slowly right or left to open. Pulling up the body of the telescopic part, (see pic B). Turning slowly right or left to lock. Turn on water supply.

- C You can precisely adjust the float basin with the red rod. Unclip the red rod. Adjust the float basin. Clip the red rod.

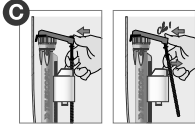
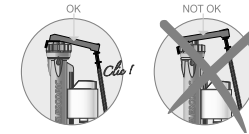

TROUBLE SHOOTING MAINTENANCE FOR JOLLYFILL SIDE AND BOTTOM ENTRY VALVES

Turn off water supply before any maintenance is carried out.

- 1 BOTTOM ENTRY
- 1 SIDE ENTRY
- 2 Remove and wash the diaphragm and reassemble in reverse order.
- 3 Remove and wash the filter restrictor and reassemble in reverse order.