

## Domestic Gas Boilers



- UNICA i ■
- VISION C ■
- MYNUTE i ■
- VISION S ■
- MYNUTE VHE ■
- BeSMART CONTROL ■

Welcome home to warmth and comfort...



When you choose a Vokèra gas boiler for your heating system, you're investing in a supremely reliable and high quality appliance that will make any home or workplace an even better place to be.

#### Why choose Vokèra

Vokèra boilers have brought warmth to more than 1.5 million homes across the UK and Ireland. With 30 years' experience designing and building boilers and systems to heat homes and small commercial premises, we are very proud of our unblemished product quality record. Reliability statistics show that our boilers are some of the best-performing in the industry. That's why we confidently offer a comprehensive warranty as standard on every boiler.

## The best choice

In our range of modern, high performance boilers, there's one to suit the home perfectly. We offer combination (combi) boilers that provide hot water and heating, as well as boilers for central heating only and water heaters. They all feature the latest innovations, for outstanding efficiency and reliability.

Vokèra boilers come in a range of sizes and capacities with different flue options, so they fit in neatly and provide optimum heating for living spaces.

We harness smart technology to make it easier and cheaper to heat the home now and into the future. Our BeSMART intelligent thermostat means you can cut bills and take control. It responds to the way you live so you heat your home and water at the times when you need it and don't waste energy when you're not around.



Welcome home to warmth and comfort	02
Boiler types – what is the best solution for me	04
Our heritage of heating expertise	06
Pioneering technology	07
Intelligent controls	08
Unica i	10
Vision C	12
Mynute i	14
Vision S	16
Mynute VHE	18
Boiler and flue compatibility	20
Choosing the right control – BeSMART	22
Choosing the right control – OpenTherm and programmable room thermostats	24
Vokèra support – Nationwide technical training	26



## Boiler types – what is the best solution for me?

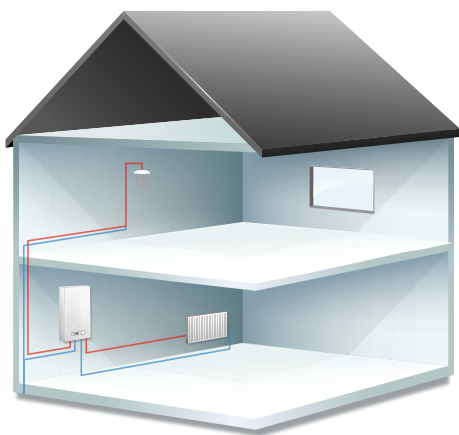

### Combi boilers

A combi (combination) boiler provides heat for central heating and domestic hot water on demand. No need for feed and expansion tanks in the loft space or a hot water storage cylinder, so a combi boiler saves space. Domestic hot water is fed from the mains supply, which maintains high water pressure, and is heated instantly.

If you live in a low water pressure area, or have several bathrooms, a combi boiler may not be suitable.

A combi boiler is an ideal boiler if you want to:

- Replace an existing combi boiler and are happy with the performance it provides
- Use the loft space or airing cupboard for another purpose and want to remove the tanks and hot water storage cylinder
- Have instant hot water on demand
- Save space

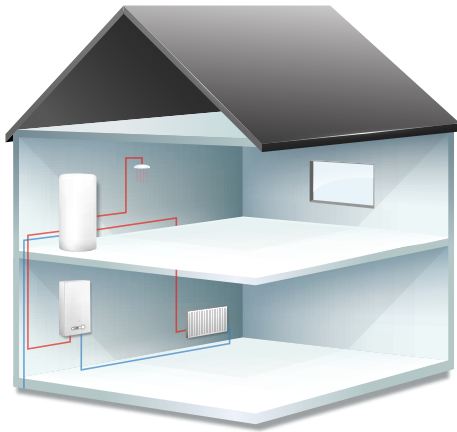

### System boilers

A system boiler is installed as part of a sealed central heating system. It's not open to atmospheric pressure because the system is kept within a closed circuit.

The system boiler connects to a storage cylinder that provides the domestic hot water. As the heating system is sealed it requires no tank in the loft space. When coupled with a mains pressure hot water storage cylinder (known as an unvented cylinder), it is well suited to properties with several bathrooms. In this configuration, good flow rates can be maintained when using more than one domestic hot water outlet at the same time.

System boilers are compatible with solar thermal. If you already have a system boiler, it can be straightforward to add a solar thermal system to it using a twin coil unvented cylinder.

**A system boiler is an ideal boiler if you want to:**

- Replace an existing system boiler and are happy with the performance your system boiler provides
- Provide hot water to be used by more than one bathroom at once using an unvented cylinder
- Reduce system pipework
- Remove feed and expansion tanks for your current boiler that are in your loft space

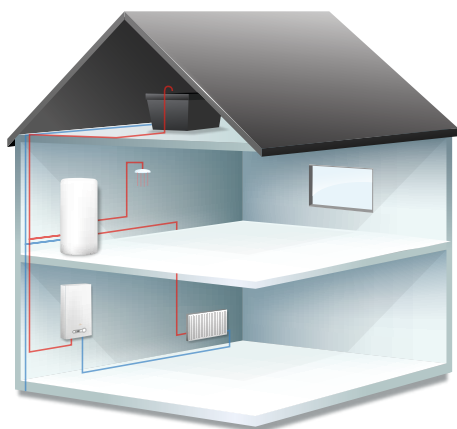

### Open vent boilers

Open vent means that the heating system is open to atmospheric pressure, with feed and expansion tanks in your loft space. An open vent boiler (also called a conventional or regular boiler) heats your radiators and, via a storage cylinder, the domestic hot water. If you currently have an open vent boiler, making a direct replacement can be a good and straightforward option, unless your property or lifestyle has changed.

Open vent boilers are also compatible with solar thermal. If there is currently an open vent boiler, it can be straightforward to add a solar thermal system.

**An open vent boiler is an ideal boiler if:**

- You want to replace an existing open vent boiler and are happy with its performance
- You have more than one bathroom
- Your mains water pressure is low

Our heritage of heating expertise...

Vokèra is an industry leader in quality home heating solutions.

**RIELLO**

We've been producing boilers for over 30 years. We operate a research and manufacturing base in Northern Italy, where we design and thoroughly test every boiler. Our parent company, Riello, has been making burners for nearly a century. Together, we're a powerful and knowledgeable team, backed by Riello's long experience and reputation for technological innovation in combustion technology and heating.

Trusted service and support

Vokèra products are designed to be straight forward and easy for installers to fit. That means it's as simple and quick as possible for a connected, efficient Vokèra boiler to make the home a cosier place straight away.

Our customer care team is at the end of a phone if you need any advice or help once the boiler is fitted. Installers have access to full technical support to make sure they have all the information they need.

If the boiler needs a service or repair, we have a team of Vokèra engineers as well as an approved agent support network working throughout the UK and Ireland. Our expert engineers achieve a 95% first time fix rate. That's why we consistently achieve a 99% customer satisfaction score.

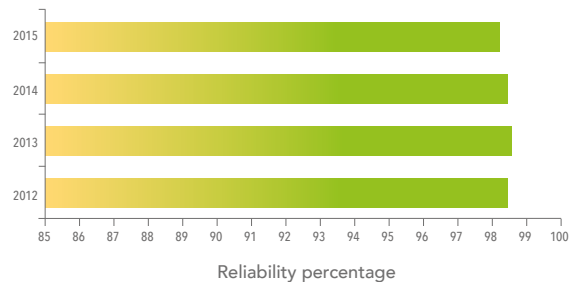
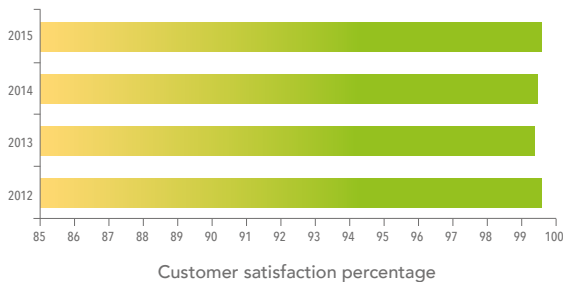



## Pioneering technology...



Heat exchanger

### High efficiency

Vokèra high efficiency condensing boilers are some of the most energy efficient appliances on the market today. Our boilers dramatically reduce wasted heat, saving money and helping protect the environment. They all meet and exceed the relevant standards for the UK and Ireland. Many boilers can be fitted with extra energy-saving controls for even greater efficiency and savings.

### Energy labelling explained

Your boiler and heating system will have an energy efficiency rating, determined by the Energy-related Products Directive (ErP). Your installer will label your system to show how it's rated. Ratings range from A to G and are colour coded from green to red. A is the most efficient. You may have seen these energy labels on other domestic appliances, such as washing machines.

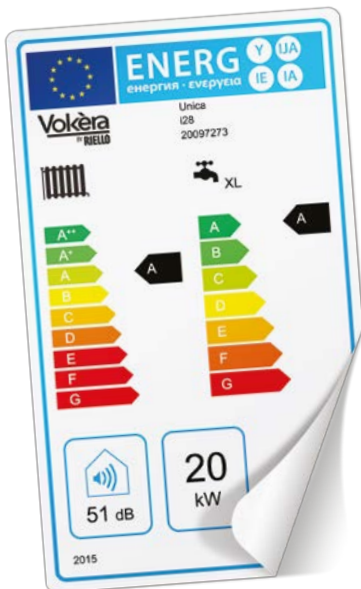

### How ErP affects homeowners and installers

If your installer fits a complete system, you'll get one energy rating and package label for the whole system. Your installer works out the overall efficiency based on all the components working together. We help installers work out the right energy rating for complete Vokèra systems, so they can give you the correct label. Find out more or get help with this online at [www.vokera.co.uk/erp/](http://www.vokera.co.uk/erp/).

When just one component is being installed, such as a replacement boiler, the boiler will have its own individual energy efficiency label, provided by Vokèra.

All of Vokèra's products exceed the minimum standards set out by the ErP directive – most of our range achieves a very high energy efficiency rating. That means that by choosing Vokèra, you can make your property more energy efficient and help reduce your energy bills.



## Intelligent controls

OpenTherm is a simple way to use sophisticated technology to maintain the most comfortable and stable temperature whilst optimising energy consumption and make extra savings on heating bills. Our programmable OpenTherm controls are designed to be easy to use and display information clearly. They're compatible with all Vokèra boilers and systems and the installation process is straightforward.

So the central heating can react to the weather, an external sensor can be added to most systems. Weather compensating technology also helps save money as well as keeping a home at the perfect temperature, day in, day out.

## BeSMART – for smarter home heating

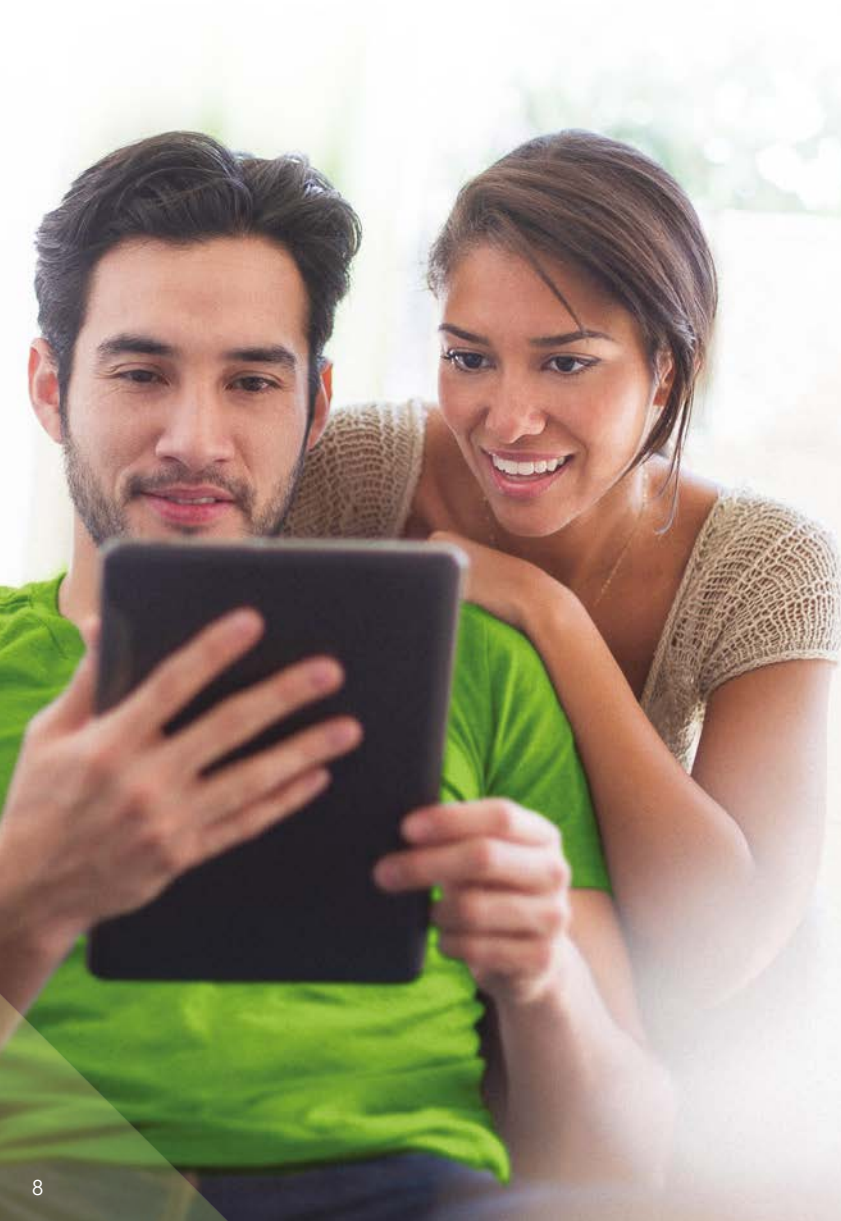

Our BeSMART Internet enabled control goes an intelligent step further and lets you control your heating wherever you are, including from a mobile phone app. BeSMART reacts automatically and intelligently to current conditions and gives you ultimate flexibility and efficiency, with different comfort settings depending on your different daily needs.





High efficiency  
domestic boiler range

# Unica i

## High efficiency combi boiler

### Dimensions and Clearances (mm)

*\*From casing or 25mm above flue elbow (whichever is applicable)*

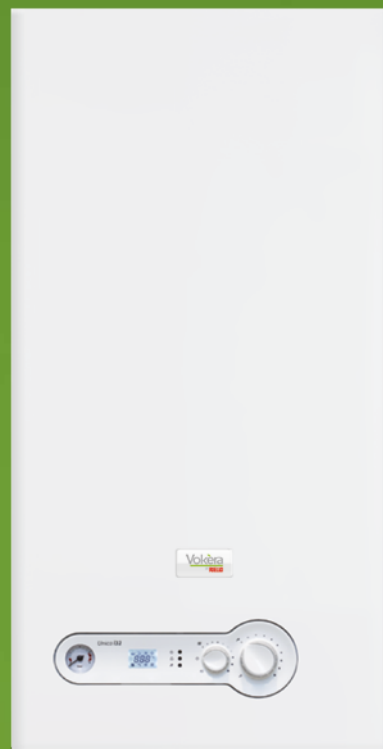
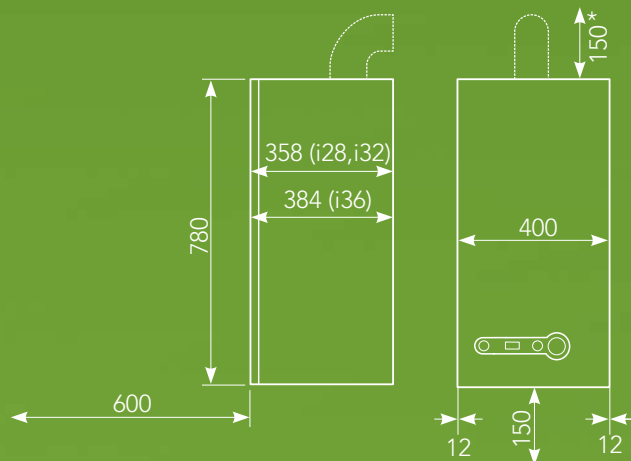

### The Unica i is a high specification condensing combi boiler range.

Advanced energy saving credentials define this product range, which boasts a class leading modulation ratio of 10:1, enabling the boiler to reduce its output in line with the demand in the home, reducing wasted energy.

Its advanced technology also allows the Unica i to connect to the Vokera OpenTherm control; not only giving complete control over the heating and hot water requirements, but saving up to £67 a year on fuel bills. As well as its advanced energy saving credentials, the Unica i provides exceptional hot water comfort.



- Fully compliant with the Energy-related Products Directive. Further efficiency can be achieved when installed with a weather compensation sensor or OpenTherm control such as BeSMART. **(Unica i32 achieves an ErP A+ system rating with these controls).**
- Compatible with energy saving controls including outside weather compensation sensor and OpenTherm programmable thermostat with 'Plug & Play' connection for a simple installation.
- 5 year parts and labour warranty.<sup>(1)</sup>
- Energy Saving Trust endorsed product.
- Rear flue option as well as the standard top flue option provides a versatile installation. Other flueing options available are; horizontal, vertical and twin flue, enabling the boiler to be sited almost anywhere in the home.



Class leading 10:1 modulation ratio

- Versatile flue options with concentric flue lengths up to 20m and twin flue lengths up to 45m.
- Exceptional modulation ratio of 10:1 maximises efficiency and comfort for the end user. Other energy saving features, including low power consumption are present.
- Pre fixing template included.
- Standard Autostop disabling function<sup>(2)</sup> that automatically changes the current operating mode and moves it permanently into the standby mode, helping Registered Social Landlords fulfill their legal obligation of an annual gas safety check.
- Front mounted heat exchanger assists in simple maintenance.
- Vokèra's unique radial design heat exchanger utilises an extruded aluminium alloy. The design and large cross-sectional area eliminate the risk of scaling or superheated areas.
- Easy to understand diagnostic display aids the service engineer in the unlikely event of a fault developing.
- Built-in frost protection protects the appliance from damage during periods of cold weather.
- Compatible with Vokèra Fuelsaver passive flue gas heat recovery device. Heat recovered from the flue exhaust gases is used to pre-heat the incoming cold mains water supply before entering the boiler, thereby reducing gas consumption and improving domestic hot water efficiency.

SPECIFICATIONS	UNICA i28	UNICA i32	UNICA i36
PRODUCT ORDER CODE	20097273	20097274	20097275
CENTRAL HEATING			
HEAT INPUT (kW)	20	25	30
MAXIMUM HEAT OUTPUT 60/80°C (kW)	19.6	24.6	29.3
MAXIMUM HEAT OUTPUT 30/50°C (kW)	21.4	26.7	31.8
DOMESTIC HOT WATER			
HEAT INPUT (kW)	28	32	36
FLOW RATE - 35°C RISE (L/MIN)	11.5	13.1	14.7
DIMENSIONS			
HEIGHT (MM)	780		
WIDTH (MM)	400		
DEPTH (MM)	358	384	
WEIGHT			
DRY WEIGHT (KG)	40	42	41
CONNECTIONS			
FLOW & RETURN	22MM		
GAS	15MM		
DHW INLET & OUTLET	15MM		
SAFETY VALVE	15MM		
ELECTRICAL			
VOLTAGE (V/Hz)	230/50		
FLUE DETAILS (CONCENTRIC)			
MAXIMUM HORIZONTAL FLUE LENGTH 60/100MM	7.85M		
MAXIMUM VERTICAL FLUE LENGTH 60/100MM	8.85M		
MAXIMUM HORIZONTAL FLUE LENGTH 80/125MM	20M	14.85M	
MAXIMUM VERTICAL FLUE LENGTH 80/125MM	25M	19.85M	
FLUE DETAILS (TWIN)			
MAX HORIZONTAL/ VERTICAL FLUE LENGTH (80MM/80MM)	50M/50M	38M/38M	
EFFICIENCY			
ErP SEASONAL SPACE HEATING ENERGY EFFICIENCY (CLASS/%)	A/93	A/94	A/93
ErP WATER HEATING EFFICIENCY (XL PROFILE) (CLASS/%)	A/85	A/84	A/84
SAP 2009 EFFICIENCY (%)	89.6	89.6	89.2
NO <sub>x</sub> CLASS	5	5	5

ACCESSORIES	
DESCRIPTION	CODE
REAR FLUE TERMINAL	29450133
TELESCOPIC FLUE TERMINAL	29450121
STANDARD BeSMART WI-FI KIT	20111860
711 OPENTHERM RF PROGRAMMABLE ROOM STAT <sup>(3)</sup>	20050690
7 DAY RF PROGRAMMABLE ROOM THERMOSTAT	20101743
OUTSIDE WEATHER COMPENSATION SENSOR <sup>(3)</sup>	2359259
SPACING FRAME	435
MAGNETIC FILTER	29450199
FUELSAVER	29450000
CONDENSE PUMP	404
WHITE PIPE COVER 400MM	518
UNICA i LPG KIT	20069593

(1) Subject to registration and annual service. (2) Autostop activation device required. Contact Vokèra Technical Support for assistance. (3) Control Interface required for use with OpenTherm and Weather compensation sensor. Code 20008401.



ErP Compliant



5 Year Warranty<sup>(1)</sup>



Modulation Ratio



Rear Flue



OpenTherm Thermostat



Fuelsaver Compatible



BeSMART Compatible



PRE FIXING JIG AND BUILT-IN FILLING LOOP



Endorsed Product



## Vision C

### High efficiency combi boiler

Dimensions and Clearances (mm)

*\*From casing or 25mm above flue elbow (whichever is applicable)*

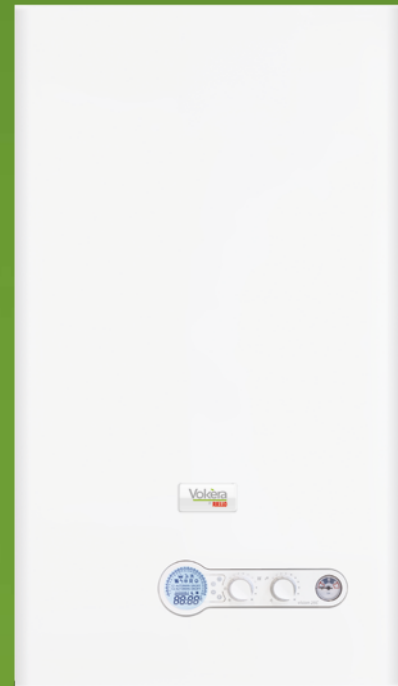
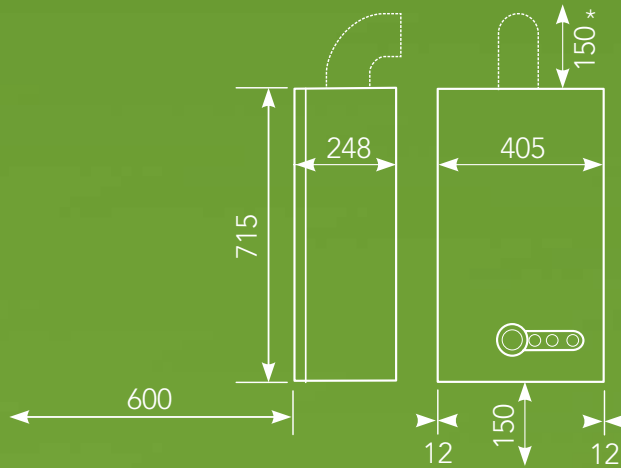

### The Vision C is a feature rich Vokèra condensing combi boiler.

This boiler has extremely compact dimensions and can fit neatly within most standard kitchen cupboards. It comes with a built-in 7 day digital clock, enabling complete control over heating timings.

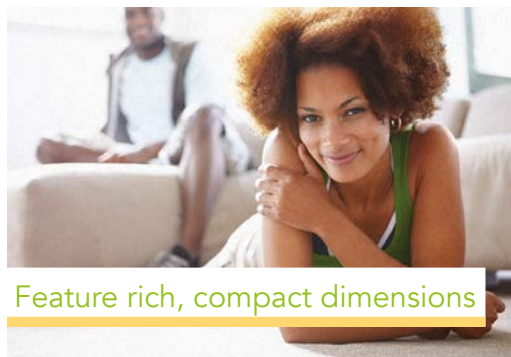

Feature rich, compact dimensions



- Fully compliant with the Energy-related Products Directive. Further efficiency can be achieved when installed with a weather compensation sensor or OpenTherm control such as BeSMART.<sup>(1)</sup>
- 5 or 7 year parts and labour warranty.<sup>(2)</sup>
- Simple to use built-in 7 day digital clock with three modes of operation and back-lit LCD display enables full control of heating times over the week, maximising control and saving energy.
- Flow rate of up to 12 l/min results in quick delivery of hot water.
- DHW pre-heat function that is easily activated by the end user.
- Small dimensions enable the boiler to be sited almost anywhere in the home, including within a kitchen cupboard.
- Rear flue option as well as the standard top flue option provides a versatile installation. Other flueing options available are; horizontal, vertical and twin flue.
- Lightweight, at only 29kg for the 25C, enables the boiler to be lifted into place easily, even in tight spaces.
- Designed for easy installation. Standard Vokèra pipework layout enables trouble-free replacement of older Vokèra models.
- Standard Autostop disabling function<sup>(3)</sup> that automatically changes the current operating mode and moves it permanently into the standby mode, helping Registered Social Landlords fulfill their legal obligation of an annual gas safety check.
- Simple commissioning; only minimal adjustments are required after installation and automatic modulation eliminates the need to range rate the boiler.
- Additional built-in functions include: SARA function for automatic temperature control and improved efficiency, anti-cycling for longer lasting component performance, frost protection and CO mode for simple servicing.
- If the boiler is to be installed in a location that is difficult to access then Vokèra's optional 7 day RF room thermostat control or BeSMART can be installed in a convenient location so the heating temperature can easily be adjusted.
- Anti-cycling control prevents wasteful on/off cycling, which reduces wear and tear for longer lasting component performance.
- Low NO<sub>x</sub> – Class 5 performance. Only 19mg/kWh for 25C provides maximum credits available for a condensing boiler under the Code for Sustainable Homes.
- Vision C is compatible with Vokèra Fuelsaver passive flue gas heat recovery device which is listed on the PCDB and validated for SAP 2009.

SPECIFICATIONS	VISION 25C	VISION 30C
PRODUCT ORDER CODE - 5 YEAR	20097278	20099224
PRODUCT ORDER CODE - 7 YEAR	29450501	29450502
<b>CENTRAL HEATING</b>		
HEAT INPUT (kW)	20	25
MAXIMUM HEAT OUTPUT 60/80°C (kW)	19.5	24.5
MAXIMUM HEAT OUTPUT 30/50°C (kW)	20.8	26.2
<b>DOMESTIC HOT WATER</b>		
HEAT INPUT (kW)	25	29
FLOW RATE - 35°C RISE (L/MIN)	10.2	12
<b>DIMENSIONS</b>		
HEIGHT x WIDTH x DEPTH (MM)	715 x 405 x 248	
<b>WEIGHT</b>		
DRY WEIGHT (KG)	29	29
<b>CONNECTIONS</b>		
FLOW & RETURN	22MM	
GAS	15MM	15MM
DHW INLET & OUTLET	15MM	15MM
SAFETY VALVE	15MM	
<b>ELECTRICAL</b>		
VOLTAGE (V/Hz)	230/50	
<b>FLUE DETAILS (CONCENTRIC)</b>		
MAXIMUM HORIZONTAL FLUE LENGTH 60/100MM	5.85M	4.85M
MAXIMUM VERTICAL FLUE LENGTH 60/100MM	6.85M	5.85M
MAXIMUM HORIZONTAL FLUE LENGTH 80/125MM	15.3M	12.8M
MAXIMUM VERTICAL FLUE LENGTH 80/125MM	20.3M	17.8M
<b>FLUE DETAILS (TWIN)</b>		
MAX HORIZONTAL / VERTICAL FLUE LENGTH (80MM/80MM)	45M/45M	40M/40M
<b>EFFICIENCY</b>		
ErP SEASONAL SPACE HEATING ENERGY EFFICIENCY (CLASS/%)	A/93	A/93
ErP WATER HEATING EFFICIENCY (XL PROFILE) (CLASS/%)	A/85	A/84
SAP 2009 EFFICIENCY (%)	89.1	89.0
NO <sub>x</sub> CLASS	5	5

ACCESSORIES	VISION 25C	VISION 30C
<b>DESCRIPTION</b>		
REAR FLUE TERMINAL	29450133	
TELESCOPIC FLUE TERMINAL	29450121	
STANDARD BeSMART WI-FI KIT	20111860	
711 OPENTHERM RF PROGRAMMABLE ROOM STAT <sup>(1)</sup>	20050690	
7 DAY RF ROOM THERMOSTAT CONTROL	20059642	
OUTSIDE WEATHER COMPENSATION SENSOR	2359259	
SPACING FRAME	20030704	
MAGNETIC FILTER	29450199	
FUELSAVER	29450000	
CONDENSE PUMP	404	
PIPE COVER	20012594	
LPG CONVERSION KITS	20045569	20029055

(1) The addition of an energy saving control will override the built-in digital control settings on the Vision combi. (2) Subject to registration and annual service. 7 year warranty offer valid for a promotional period, terms and conditions apply. (3) Autostop activation device required.



ErP Compliant



7 Year Warranty<sup>(2)</sup>



Built-in Time Clock



Rear Flue



Lightweight & Compact



Fuelsaver Compatible



Built-in Filling Loop



BeSMART Compatible



Endorsed Product

# Mynute i

## High efficiency system boiler

### Dimensions and Clearances (mm)

*\*From casing or 25mm above flue elbow (whichever is applicable)*

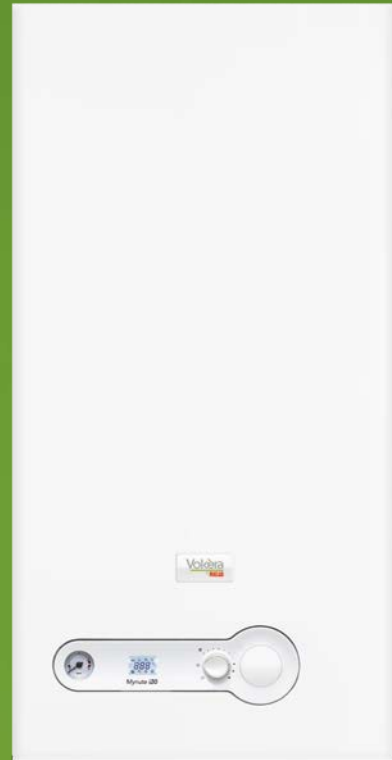
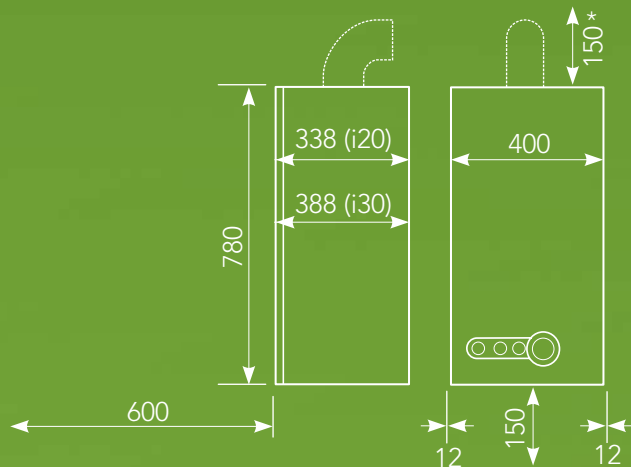

**Vokèra Mynute i boilers are simple to operate and the ideal boiler where space is at a premium.**

The Mynute i condensing system boilers are for central heating only, but can provide for domestic hot water needs when installed with a storage hot water cylinder.

The Mynute i is an A rated efficiency appliance that can save up to 30% on gas bills, it can also achieve a further energy saving by using Vokèra's outside weather compensation control.

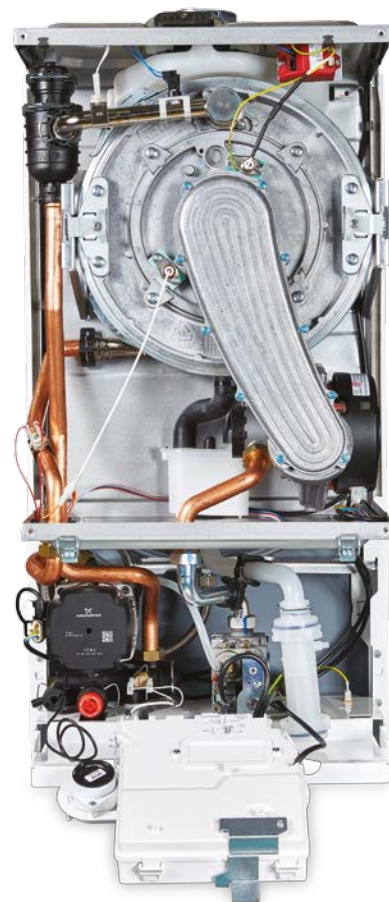



- Fully compliant with the Energy-related Products Directive.
- 5 year parts and labour warranty.<sup>(1)</sup>
- Exceptional modulation ratio of 10:1 maximises efficiency and comfort for the end user.
- Simple to use back-lit LCD display ensures end users can easily operate and adjust the appliance.
- Rear flue option as well as the standard top flue option provides a versatile installation. Other flueing options available are; horizontal, vertical and twin flue.
- Front mounted heat exchanger assists in simple maintenance.
- Built-in relay enables use of a wide variety of external controls and switching devices.



- Dual temperature range – easily configured to suit under-floor heating systems, with two built-in temperature ranges to suit either high or low temperature systems.
- Low pressure loss reduces noise and increases pump performance.
- Simple commissioning; only minimal adjustments are required after installation and automatic modulation eliminates the need to range rate the boiler.
- Low NO<sub>x</sub> – Class 5 performance.
- Anti-seize function protects the pump from sticking during long periods of inactivity.
- Anti-cycling control prevents energy wasteful on/off cycling and reduces wear and tear.
- Built-in frost protection, which protects the appliance from damage during periods of cold weather.
- Standard Autostop disabling function<sup>(2)</sup> that automatically changes the current operating mode and moves it permanently into the standby mode, helping Registered Social Landlords fulfill their legal obligation of an annual gas safety check.

SPECIFICATIONS	MYNUTE i20	MYNUTE i30
PRODUCT ORDER CODE	20101253	20101256
CENTRAL HEATING		
HEAT INPUT (kW)	20	30
MAXIMUM HEAT OUTPUT 60/80°C (kW)	19.6	29.2
MAXIMUM HEAT OUTPUT 30/50°C (kW)	21.4	31.8
MODULATION RATIO		
MODULATION RATIO	10.1	
DIMENSIONS		
HEIGHT (MM)	780	
WIDTH (MM)	400	
DEPTH (MM)	338	388
WEIGHT		
DRY WEIGHT (KG)	36	38
CONNECTIONS		
FLOW & RETURN	22MM	
GAS	15MM	
SAFETY VALVE	15MM	
CONDENSATE	21MM	
ELECTRICAL DATA		
VOLTAGE (V/Hz)	230/50	
FLUE DETAILS (CONCENTRIC)		
MAXIMUM HORIZONTAL FLUE LENGTH 60/100MM	7.8M	7.85M
MAXIMUM VERTICAL FLUE LENGTH 60/100MM	8.8M	8.85M
MAXIMUM HORIZONTAL FLUE LENGTH 80/125MM	20M	14.85M
MAXIMUM VERTICAL FLUE LENGTH 80/125MM	21M	15.85M
FLUE DETAILS (TWIN)		
MAXIMUM HORIZONTAL FLUE LENGTH (80MM/80MM)	50M/50M	38M/38M
MAXIMUM VERTICAL FLUE LENGTH (80MM/80MM)		
EFFICIENCY		
ErP SEASONAL SPACE HEATING ENERGY EFFICIENCY (CLASS/%)	A/93	A/93
SAP 2009 EFFICIENCY (%)	89.5	89.1
NO <sub>x</sub> CLASS	5	5

ACCESSORIES	
DESCRIPTION	CODE
REAR FLUE TERMINAL	29450133
TELESCOPIC FLUE TERMINAL	29450121
SPACING FRAME	2359689
MAGNETIC FILTER	29450199
CONDENSE PUMP	404
PIPE COVER	518
MYNUTE i LPG CONVERSION KIT	20069593

(1) Subject to registration and annual service. (2) Autostop activation device required.



ErP Compliant



5 Year Warranty<sup>(1)</sup>



Modulation Ratio



Rear Flue



Radial Heat Exchanger



Solar Thermal Compatible



BUILT-IN ON-BOARD RELAY



Endorsed Product

## Vision S

### High efficiency system boiler

#### Dimensions and Clearances (mm)

*\*From casing or 25mm above flue elbow (whichever is applicable)*

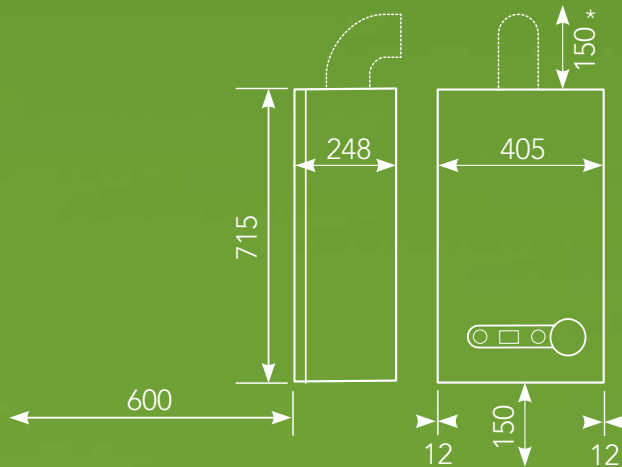

#### The Vision S is a feature rich Vokèra condensing system boiler.

This boiler has extremely compact dimensions measuring 715mm (H) x 405mm (W) x 248mm (D) and can fit neatly within most standard kitchen cupboards.

The Vision system benefits from up to 93% efficiency (ErP space heating) when combined with Vokèra intelligent controls.

Installer friendly it features a rear flue option, flexible installation and up to 7 year warranty.



- Fully compliant with the Energy-related Products Directive.
- 5 or 7 year parts and labour warranty.<sup>(1)</sup>
- Small dimensions enable the boiler to be sited almost anywhere in the home, including within a kitchen cupboard.
- Rear flue option as well as the standard top flue option provides a versatile installation. Other flueing options available are; horizontal, vertical and twin flue.
- Lightweight, at only 27kg for the 20S, enables the boiler to be lifted into place easily, even in tight spaces.
- Designed for easy installation. Standard Vokèra pipework layout enables trouble-free replacement of older Vokèra models.
- Standard Autostop disabling function<sup>(2)</sup> that automatically changes the current operating mode and moves it permanently into the standby mode, helping Registered Social Landlords fulfill their legal obligation of an annual gas safety check.



Cupboard fit without compromise

- Simple commissioning; only minimal adjustments are required after installation and automatic modulation eliminates the need to range rate the boiler.
- Additional built-in functions include: SARA function for automatic temperature control and improved efficiency, anti-cycling for longer lasting component performance, frost protection and CO mode for simple servicing.
- Anti-cycling control prevents wasteful on/off cycling, which reduces wear and tear for longer lasting component performance.
- Low NO<sub>x</sub> – Class 5 performance. Only 19mg/kWh for 20S provides maximum credits available for a condensing boiler under the Code for Sustainable Homes.

SPECIFICATIONS	VISION 20S	VISION 25S
PRODUCT ORDER CODE - 5 YEAR	20099228	20099229
PRODUCT ORDER CODE - 7 YEAR	29450503	29450504
<b>CENTRAL HEATING</b>		
HEAT INPUT (kW)	20	25
MAXIMUM HEAT OUTPUT 60/80°C (kW)	19.5	24.5
MAXIMUM HEAT OUTPUT 30/50°C (kW)	20.8	26.2
<b>DOMESTIC HOT WATER</b>		
HEAT INPUT (kW)	-	-
FLOW RATE - 35°C RISE (L/MIN)	-	-
<b>DIMENSIONS</b>		
HEIGHT x WIDTH x DEPTH (MM)	715 x 405 x 248	
<b>WEIGHT</b>		
DRY WEIGHT (KG)	27	28
<b>CONNECTIONS</b>		
FLOW & RETURN	22MM	
GAS	22MM	
SAFETY VALVE	15MM	
CONDENSATE	21MM	
<b>ELECTRICAL</b>		
VOLTAGE (V/HZ)	230/50	
<b>FLUE DETAILS (CONCENTRIC)</b>		
MAXIMUM HORIZONTAL FLUE LENGTH 60/100MM	5.85M	4.85M
MAXIMUM VERTICAL FLUE LENGTH 60/100MM	6.85M	5.85M
MAXIMUM HORIZONTAL FLUE LENGTH 80/125MM	15.3M	12.8M
MAXIMUM VERTICAL FLUE LENGTH 80/125MM	16.3M	13.8M
<b>FLUE DETAILS (TWIN)</b>		
MAX HORIZONTAL / VERTICAL FLUE LENGTH (80MM/80MM)	45M/45M	40M/40M
<b>EFFICIENCY</b>		
ErP SEASONAL SPACE HEATING ENERGY EFFICIENCY (CLASS/%)	A/93	A/93
ErP WATER HEATING EFFICIENCY (XL PROFILE) (CLASS/%)	-	-
SAP 2009 EFFICIENCY (%)	89.0	89.1
NO <sub>x</sub> CLASS	5	5

ACCESSORIES	VISION 20S	VISION 25S
<b>DESCRIPTION</b>		
REAR FLUE TERMINAL	29450133	
TELESCOPIC FLUE TERMINAL	29450121	
SPACING FRAME	20030704	
MAGNETIC FILTER	29450199	
FUELSAVER	29450000	
CONDENSE PUMP	404	
PIPE COVER	20012594	
LPG CONVERSION KITS	20045579	20029055

(1) Subject to registration and annual service. 7 year warranty offer valid for a promotional period, terms and conditions apply.  
 (2) Autostop activation device required.



ErP Compliant



7 Year Warranty<sup>(2)</sup>



Rear Flue



Lightweight & Compact



Optional Pipe Cover



Easy Installation



BUILT-IN ON-BOARD RELAY



Endorsed Product



# Mynute VHE

## High efficiency open vent boiler

### Dimensions and Clearances (mm)

\*From casing or 25mm above flue elbow (whichever is applicable)

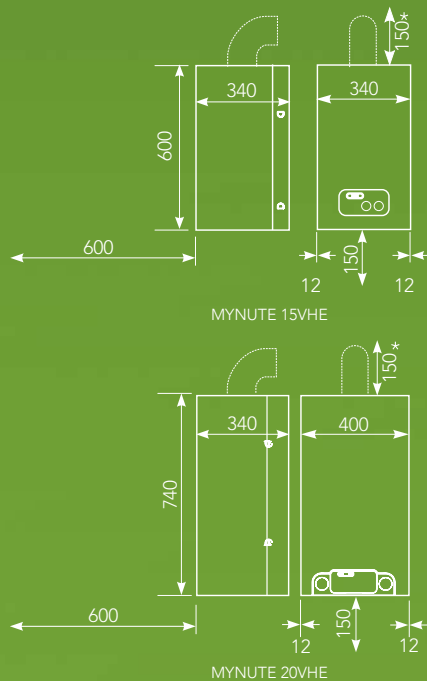

### The Mynute VHE is Vokèra's open vent condensing boiler.

It has extremely small dimensions with the Mynute 15VHE model fitting in a kitchen cupboard. Also the range has an intuitive control panel which is easily operated and used to adjust the appliance.

The Mynute VHE is ideal to use with hot water storage cylinders and has versatile flueing options available.



Mynute 15VHE shown

- Fully compliant with the Energy-related Products Directive.
- 2 year parts and labour warranty.<sup>(1)</sup>
- Vokèra's unique radial design heat exchanger utilises an extruded aluminium alloy. The design and large cross-sectional area eliminate the risk of scaling or superheated areas.
- Low pressure loss reduces noise and increases pump performance.
- Simple commissioning; only minimal adjustments are required after installation and automatic modulation eliminates the need to range rate the boiler.
- Top and bottom pipe connections on Mynute 15VHE for flexibility and ease of installation.



- Low NO<sub>x</sub> – Class 5 performance.
- Only requires one metre minimum static head.
- Anti-cycling control reduces on/off cycling, increasing efficiency of the boiler and reducing fuel costs.
- Built-in frost protection, which protects the appliance from damage during periods of cold weather. External pump must be connected directly to the boiler to ensure this function operates.
- Versatile, horizontal, vertical or rear flueing options enable the boiler to be sited almost anywhere in the home.\* Flue type certification also permits the Mynute VHE to be used with Vokèra's 80mm PP flexible flue liner and B23 applications.
- Anti-seize function protects the pump from sticking during long periods of inactivity.
- Standard Autostop disabling function<sup>(2)</sup> that automatically changes the current operating mode and moves it permanently into the standby mode, helping Registered Social Landlords fulfill their legal obligation of an annual gas safety check.
- Intuitive control panel ensures end users can easily operate and adjust the appliance.
- Purge cycle feature. The boiler will automatically run a two minute purge cycle when the boiler is switched on for the first time before the burner ignites to expel any air that may be present in the system.
- Compatible with Vokèra's MCS accredited Zenith solar thermal collectors and Aquaflow unvented single and twin coil cylinders.

SPECIFICATIONS	MYNUTE 15VHE	MYNUTE 20VHE
PRODUCT ORDER CODE	884	886
CENTRAL HEATING		
HEAT INPUT (kW)	15	20
MAXIMUM HEAT OUTPUT 60/80°C (kW)	14.6	19.7
MAXIMUM HEAT OUTPUT 30/50°C (kW)	15.7	21.2
DIMENSIONS		
HEIGHT (MM)	640	740
WIDTH (MM)	340	400
DEPTH (MM)	340	340
WEIGHT		
DRY WEIGHT (KG)	25	28
CONNECTIONS		
FLOW & RETURN		22MM
GAS		15MM
CONDENSATE		21MM
ELECTRICAL DATA		
VOLTAGE (V/Hz)		230/50
FLUE DETAILS (CONCENTRIC)		
MAXIMUM HORIZONTAL FLUE LENGTH 60/100MM		7.8M
MAXIMUM VERTICAL FLUE LENGTH 60/100MM		8.8M
MAXIMUM HORIZONTAL FLUE LENGTH 80/125MM		25M
MAXIMUM VERTICAL FLUE LENGTH 80/125MM	30M	25M
FLUE DETAILS (TWIN)		
MAXIMUM HORIZONTAL FLUE LENGTH (80MM/80MM)		40M/40M
MAXIMUM VERTICAL FLUE LENGTH (80MM/80MM)		40M/40M
EFFICIENCY		
ErP SEASONAL SPACE HEATING ENERGY EFFICIENCY (CLASS/%)	A/93	A/91
SAP 2009 EFFICIENCY (%)	89.3	88.8
NO <sub>x</sub> CLASS	5	5

ACCESSORIES	
DESCRIPTION	CODE
REAR FLUE TERMINAL (15kW ONLY)	533
TELESCOPIC FLUE TERMINAL	29450121
SPACING FRAME (20kW ONLY)	2359689
MAGNETIC FILTER	29450199
CONDENSE PUMP	404
WHITE PIPE COVER 400MM (20kW)	518
MYNUTE VHE LPG CONVERSION KIT	01005446

\*The Mynute 15VHE can also be rear flued  
 (1) Subject to registration and annual service. (2) Autostop activation device required.



ErP Compliant



2 Year Warranty<sup>(1)</sup>



Cupboard Fit



Rear Flue



Radial Heat Exchanger



Versatile Flueing Options

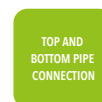

TOP AND BOTTOM PIPE CONNECTION



Endorsed Product

# Boiler and flue compatibility

## 60/100 concentric flue range

The 60/100 condensing range is suitable for all current Vokèra high efficiency (condensing) appliances.

When used in the horizontal plane, the flue system (excluding horizontal terminal) should be installed so that it has a 1° – 3° fall back to the boiler (17mm – 51mm per metre). This lets any fluid drain via the condensate connection and trap.

60/100mm concentric flue systems						
CODE	FEATURE	UNICA i	VISION C	MYNUTE i	VISION S	MYNUTE VHE
29450121	TELESCOPIC HORIZONTAL FLUE TERMINAL	✓	✓	✓	✓	✓
29450120	HORIZONTAL FLUE TERMINAL	✓	✓	✓	✓	✓
522	PLUME MANAGEMENT KIT	✓	✓	✓	✓	✓
29450131	PLUME MANAGEMENT KIT EXTENSION	✓	✓	✓	✓	✓
29450123	90-DEG BEND	✓	✓	✓	✓	✓
29450124	45-DEG BEND (PAIR)	✓	✓	✓	✓	✓
29450125	500MM EXTENSION	✓	✓	✓	✓	✓
29450126	1000MM EXTENSION	✓	✓	✓	✓	✓
29450127	2000MM EXTENSION	✓	✓	✓	✓	✓
29450128	TELESCOPIC EXTENSION	✓	✓	✓	✓	✓
529	WALL BRACKETS (5 x 100MM)	✓	✓	✓	✓	✓
29450122	VERTICAL FLUE TERMINAL	✓	✓	✓	✓	✓
531	PITCHED ROOF FLASHING PLATE	✓	✓	✓	✓	✓
532	FLAT ROOF FLASHING PLATE	✓	✓	✓	✓	✓
533	TELESCOPIC REAR FLUE	✗	✗	✓	✗	3 <sup>(2)</sup>
29450133	TELESCOPIC REAR FLUE	✓	✓	✓	✓	3 <sup>(2)</sup>
534 <sup>(3)</sup>	BRICK RED NOSE CONE	✓	✓	✓	✓	✓
535 <sup>(3)</sup>	BEIGE NOSE CONE	✓	✓	✓	✓	✓
29450130	WHITE NOSE CONE	✓	✓	✓	✓	✓
487	45 DEGREE PLUME DIVERTER	✓	✓	✓	✓	✓

(1) Contact Vokèra Technical for advice. (2) 15kW output only. (3) Available as special order only. Minimum order quantities apply.



White nose cone  
60/100mm concentric flue  
Code: 29450130



Telescopic horizontal flue terminal  
60/100mm concentric flue  
Code: 29450121



45 degree plume diverter  
60/100mm concentric flue  
Code: 487



Plume management kit  
60/100mm concentric flue  
Code: 522

# Boiler and flue compatibility

## 80/125 concentric flue range

The 80/125 range can be used for longer runs. An adaptor is needed to convert the flue outlet from 100mm to 125mm.

When used in the horizontal plane, the flue system (excluding horizontal terminal) should be installed so that it has a 1° – 3° fall back to the boiler (17mm - 51mm per metre). This will enable any fluid to drain via the condensate connection and trap.

### 80/125mm concentric flue systems

CODE	FEATURE	UNICA i	VISION C	MYNUTE i	VISION S	MYNUTE VHE
413	HORIZONTAL TERMINAL	✓	✓	✓	✓	✓
414	VERTICAL TERMINAL	✓	✓	✓	✓	✓
415	90 DEGREE BEND	✓	✓	✓	✓	✓
416	45 DEGREE BEND (SINGLE)	✓	✓	✓	✓	✓
417 <sup>(1)</sup>	250MM EXTENSION	✓	✓	✓	✓	✓
418	500MM EXTENSION	✓	✓	✓	✓	✓
419	1000MM EXTENSION	✓	✓	✓	✓	✓
420	2000MM EXTENSION	✓	✓	✓	✓	✓
422 <sup>(1)</sup>	TELESCOPIC EXTENSION	✓	✓	✓	✓	✓
423	WALL BRACKETS (5 x 125MM)	✓	✓	✓	✓	✓
424	BOILER TOP ADAPTOR FOR HE APPLIANCES	✓	✓	✓	✓	✓
425 <sup>(1)</sup>	FIXED OFFSET	✓	✓	✓	✓	✓
426	SILICON LUBRICANT	✓	✓	✓	✓	✓
531	PITCHED ROOF FLASHING PLATE	✓	✓	✓	✓	✓
532	FLAT ROOF FLASHING PLATE	✓	✓	✓	✓	✓

(1) Available by special order



90 degree bend / 45 degree bend  
80/125mm concentric flue  
Code: 415 / 416



500 / 1000 / 2000mm extension  
80/125mm concentric flue  
Code: 418 / 419 / 420



Pitched roof flashing plate  
80/125mm concentric flue  
Code: 531



Flat roof flashing plate  
80/125mm concentric flue  
Code: 532



## Choosing the right control – intelligent, energy saving controls and thermostats

The smarter way for you to control your home heating from your mobile and save money.

BeSMART is one of the first Internet enabled heating control systems, designed so that every home can enjoy the benefits of intelligent heating control. Made to complement the Vokèra boiler range, it's also compatible with most other residential boilers. It's the ideal replacement for older thermostats. BeSMART puts you in control of when you heat your home and water, to suit your schedule and lifestyle, plus it can help you cut your energy bills. Learn more about BeSMART at [www.vokera.co.uk/besmart](http://www.vokera.co.uk/besmart).





Control home heating from anywhere, via smartphone, tablet or desktop



Compatible with the majority of boiler brands, not just Vokèra



Manage up to 8 different heating zones from anywhere in the world











Weather compensation adjusts boiler output to reflect the outside climate



Programme up to 3 comfort levels



Alerts you and the Vokèra Service Centre if something goes wrong, for a fast repair with the least disruption

BeSMART ACCESSORIES:		
CODE		DESCRIPTION
20111860		<b>STANDARD BESMART WI-FI KIT</b> KIT INCLUDES THE BeSMART THERMOSTAT AND WI-FI BOX AND POWER SUPPLY (ALSO INCLUDES: BATTERIES, BOILER OT WIRING KIT, WALL FIXINGS, ADHESIVE MAGNETIC FIXING STRIP AND INSTRUCTIONS).
20111875		<b>BeSMART THERMOSTAT</b> FOR USE WITH MULTI-ZONE APPLICATIONS - CAN BE COUPLED TO AN EXISTING WI-FI BOX TO ENABLE MULTI-ZONE CONTROL (ALSO INCLUDES: BATTERIES AND WALL FIXINGS).
20101743		<b>7 DAY RF PROGRAMMABLE ROOM THERMOSTAT</b> FOR USE WITH MULTI-ZONE APPLICATIONS - CAN BE COUPLED TO AN EXISTING WI-FI BOX TO ENABLE MULTI-ZONE CONTROL (ALSO INCLUDES: BATTERIES AND WALL FIXINGS).
20111890		<b>WI-FI BOX</b> ENABLES EXPANSION OR UPGRADE OF EXISTING BeSMART THERMOSTAT THEREBY ENABLING ENHANCED FUNCTIONALITY VIA THE BeSMART APP (ALSO INCLUDES: WALL FIXINGS, MAGNETIC FIXING STRIP, WI-FI BOX POWER SUPPLY AND INSTRUCTIONS).
20112079		<b>BOILER RF RECEIVER</b> PRE-WIRED AND CAN BE USED TO CONFIGURE THE BeSMART THERMOSTAT INTO A STANDARD RF CONTROL; AND CAN ALSO BE USED IN THOSE OCCASIONS WHERE THE BOILER LOCATION HAS A POOR OR ABSENT WI-FI SIGNAL (ALSO INCLUDES: MAGNETIC FIXING STRIP).
20112080		<b>RF OUTSIDE SENSOR KIT (PHOTOVOLTAIC)</b> RF TEMPERATURE SENSOR (PHOTOVOLTAIC) FOR WEATHER COMPENSATION CONTROL. ONLY FOR COMPATIBLE BOILERS. (ALSO INCLUDES: BOILER RECEIVER WITH PRE-WIRED CONNECTOR AND WALL FIXINGS).
20112083		<b>WI-FI ROUTER FOR SIM CARD</b> SIM CARD ROUTER, PLUGS DIRECTLY IN TO A 230V POWER SOCKET TO CREATE A WI-FI NETWORK AND CONNECT BeSMART TO THE INTERNET. IDEAL FOR SECOND HOMES (DATA REQUIRED SIM CARD, NOT INCLUDED).
20112112		<b>WI-FI EXTENDER</b> EXTENDS AND IMPROVES THE WI-FI SIGNAL IN AREAS OF YOUR HOME WHERE THE WI-FI SIGNAL STRENGTH IS POOR OR INADEQUATE.

For more information and technical details please contact your BeSMART specialist or visit: [www.besmart-home.com](http://www.besmart-home.com)

### Typical Open Therm Multi-Zone Configuration

Programmable Wi-Fi Thermostat For Zone Valve Control and Boiler OpenTherm Connection

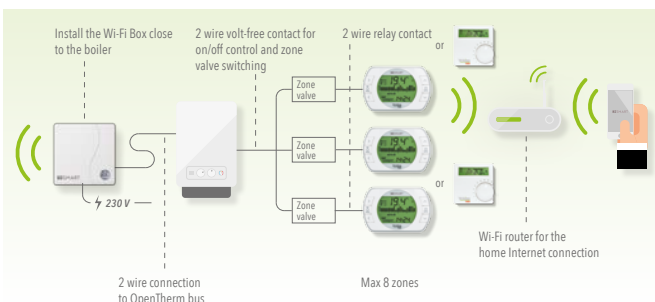

This configuration = ErP Class VIII (+5%)



# Choosing the right control - intelligent, energy saving controls and thermostats



Code: 2359259

## Outside weather compensation sensor

The outside weather compensation sensor helps provide a consistent and comfortable room temperature. It works by regulating boiler flow depending on the outside weather conditions.

Most Vokèra models come with weather compensation technology built-in. If you add this external sensor, you can benefit from even further energy savings. The weather compensation sensor can also be installed with the Vokèra OpenTherm programmable room thermostat, for even greater energy savings.

Installing a weather compensation sensor onto a condensing boiler can increase the efficiency by 2% (SAP 2009).

RF outside weather compensation sensor (photovoltaic) – 29450145.



Code: 20050690

## 711 OpenTherm RF programmable room thermostat

OpenTherm advanced control technology takes over the management of the heating flow temperature and raises or lowers the flow temperature from the boiler to maintain the desired room temperature.

When OpenTherm manages the flow temperature, it works to maintain a low flow temperature. Condensing boilers are at their peak efficiency at lower flow and return temperatures, helping reduce energy use and bills without compromising on comfort.

It's easy to connect to the Unica i combi boiler using the Plug & Play Tyco socket that means no Part P qualified electrician is required to fit it.







Code: 20101743 (RF)  
Code: 20063874 (Hard wired)



Code: 20059642

### 7 day programmable room thermostat

This 'on / economy / off' programmable room thermostat gives you easy control over boiler heating timings and temperatures over a seven day period. Both RF (wireless) and hard-wired versions available to make it easy to install.

This room thermostat can be configured as a seven day programmer, a 5+2 day programmer with up to 24 temperature changes a day or as an untimed room thermostat. Configured for use with the Compact A combi boiler, it's easy and quick to connect the receiver to the boiler using the Plug & Play Tyco socket.

The RF version is compatible with BeSMART and can be used independently with the Wi-Fi Box (20111890) and BeSMART App.

### RF room thermostat

This 'on / off' room thermostat can be used to adjust the set room temperature. It's ideal for the Vision C boiler, as the user can conveniently adjust their heating temperature without interfering with any programmed heating timings that have been set on the Vision C boiler's built-in seven-day digital clock.

It's also compatible with all the current Vokera ranges.<sup>(1)</sup>

*(1) Contact Vokera Technical Support for advice.*

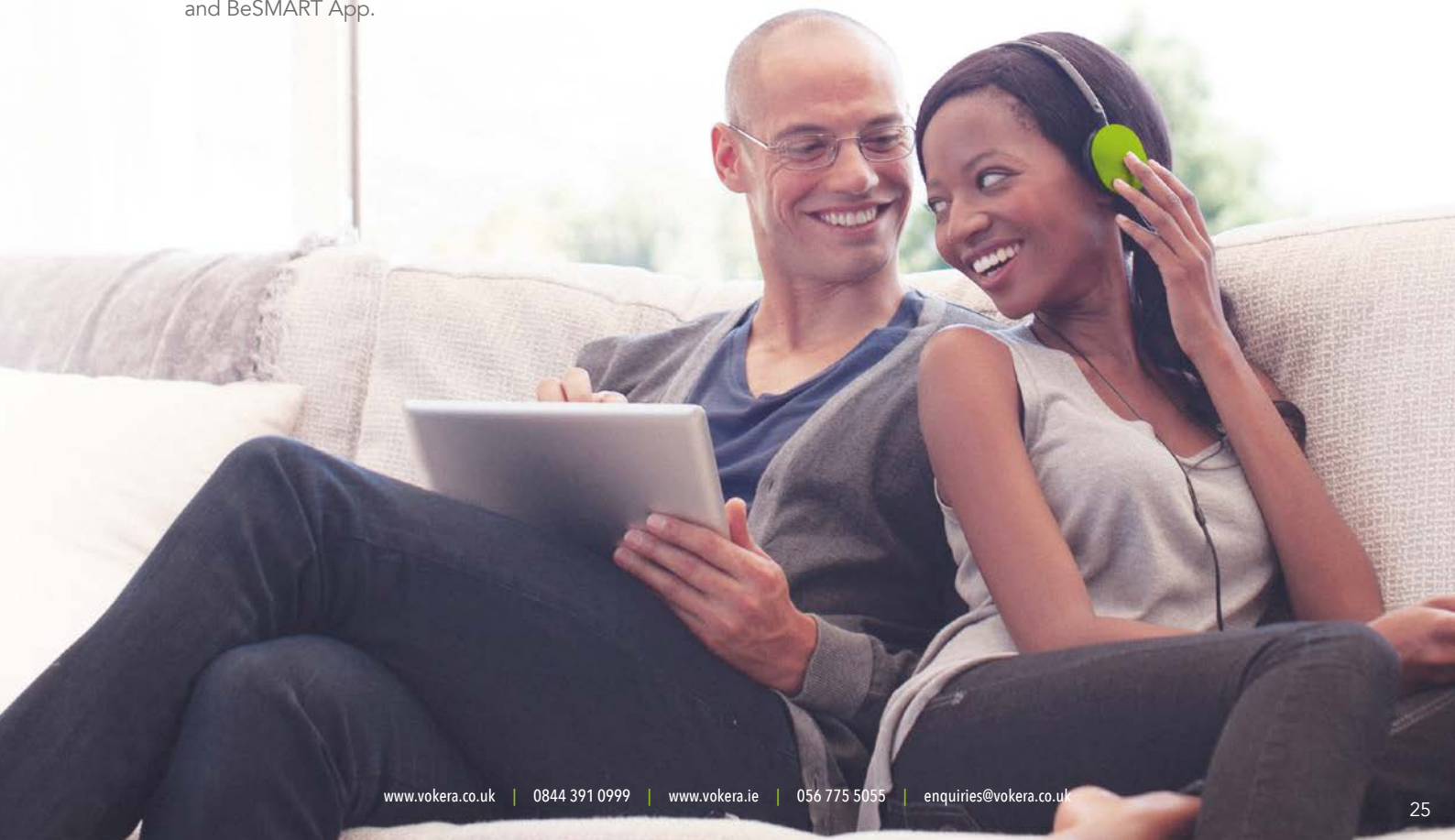



# Vokèra support

## Nationwide technical training

Vokèra technical training delivers real value to Gas Safe Registered engineers. Our technical training focuses on an engineer's need to get to know our products so they can deliver quick and simple installation or repair services. Our technical training covers the appliance range, installation, operation, wiring, flueing, benchmark, fault finding and commissioning. Installers who attend must be Gas Safe Registered.

For more information or for installers to book a course call 0844 391 0999 (option 5) or email [training@vokera.co.uk](mailto:training@vokera.co.uk)

VOKÈRA PRODUCT COURSES	PRICE
BeSMART & Controls Course (includes FREE BeSMART)	£99 plus VAT
New Entrants Course	£50 plus VAT (FREE for Affinity members)
High Efficiency Product Course	£50 plus VAT (FREE for Affinity members)
Fault Finding Product Course	£50 plus VAT (FREE for Affinity members)
Renewables Overview Product Course inc. Solar Thermal and Air Source Heat Pumps	£50 plus VAT (FREE for Affinity members)
Tailored Workshops	£99 plus VAT (20% off with Affinity)
Individual Courses	£99 plus VAT (20% off with Affinity)



### Certificated Courses

All certificated courses are accredited by LOGIC Certification. Our range of certificated courses, include:

CERTIFIED COURSES	DURATION	PRICE
Energy Efficiency Certificate	1 Day	POA (20% Off with Affinity)
G3 Domestic HWSS Certificate	1 Day	POA (20% Off with Affinity)



Vokèra offers training nationwide:

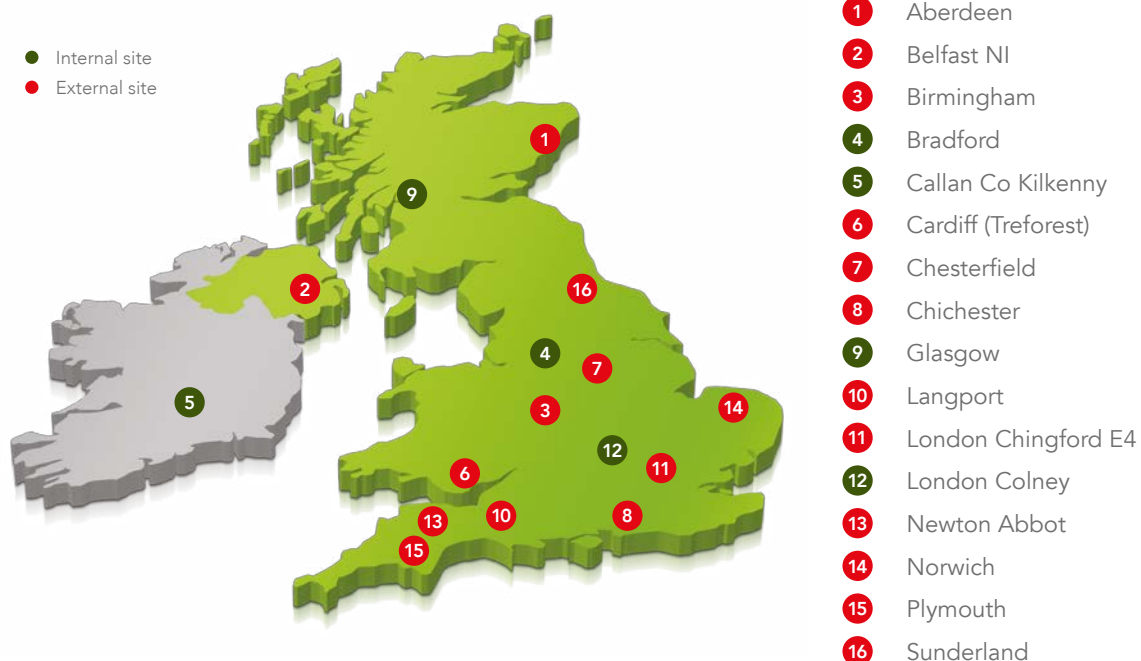





Domestic Gas Boilers



Commercial Gas Boilers



Solar Thermal



Heat Pumps



Water Heating



Smart Controls



Spares & Accessories



Service

Registered address:

Vokèra Limited  
Borderlake House  
Unit 7 Riverside Industrial Estate  
London Colney  
Herts AL2 1HG

[enquiries@vokera.co.uk](mailto:enquiries@vokera.co.uk)  
[www.vokera.co.uk](http://www.vokera.co.uk)

Sales, General Enquiries:  
T 0844 391 0999  
F 0844 391 0998

Vokèra Ireland  
Westcourt Business Park  
Callan  
Kilkenny  
R95 PW40

[www.vokera.ie](http://www.vokera.ie)

T 056 775 5055  
F 056 775 5060



© 2017 Vokèra Limited.  
We reserve the right to change specification without prior notice.  
Consumers statutory rights are not affected.  
All rights reserved. E&OE.

A Riello Group Company. Company Reg No: 1047779

Issue 01/17/BW