

25W Dual Head Motion Activated Floodlight

User Manual

01 / WARNING

- Failure to install and wire this fixture in accordance with the National Electrical Codes (NEC), all applicable Federal, State and Local electrical codes, as well as specific UL safety standards for the intended working environment (location/application) may cause personal injury, death and/or property damage.
- Due to the risk of fire or electric shock, the installation of this device requires knowledge of luminaries' electrical systems. If NOT qualified, DO NOT attempt the installation and contact a qualified electrician.
- DO NOT alter, relocate or remove the wiring, lamp holder, power supply or any other electrical component.
- To prevent wiring damage or abrasion, DO NOT expose the wiring to edges of sheet metal or other sharp objects.
- DO NOT operate this device if there's any visible damage to it.
- DO NOT operate this device if there's any sign of smoke, steam, over-heating or crackling noise that can be heard from the device.
- The manufacturer will NOT be deemed liable or held responsible for any damage caused by faults or manufacturing defects that may be present in any of its products or the misuse or incorrect installation of the device.
- BEFORE INSTALLING THIS FIXTURE, TURN OFF THE POWER AT THE FUSE BOX OR CIRCUIT BREAKER. Make sure that the fixture is grounded per National Electrical Codes (NEC).
- DO NOT remove the back plate, or the waterproof performance might be affected.

02 / INSTALLATION

1. Tools needed: Philip's and Flathead screwdriver, adjustable wrench, wire nuts, electrical tape, and silicone caulk.
2. Exercise care when handling the fixture to avoid cuts or abrasions, to help prevent the possibility of electrical shock, it is recommended to use rubber sole shoes.
3. Carefully unpack and check contents of the box to be sure everything is included.
4. Turn OFF power at the circuit breaker box.
5. Install Crossbar (12) to Junction Box (not included) (13) using two 3/4" Crossbar Screws (11).
6. Electrical Connections: Make sure the supply wires and ground wires of fixture go through the Gasket (5). Attach green or bare copper wire and the Ground Wire (8) to the Crossbar (12) using the ground nut of the crossbar. (Ground wire must be properly attached or unit may not work). Connect the white supply wire to the White Wire (6), cover them with a Wire Nut (9) or twist together and cover really well with electrical tape. Connect the black supply wire to the Black Wire (7), cover them with a Wire Nut (9) or twist together and cover really well with electrical tape. Push the connected wires back into the electrical box.
7. Install Bracket Screw (2) into center hole of Mount Base (4). Align fixture over Junction Box (13) with Gasket (5) between it and the canopy. Secure the unit to Crossbar (12) by tightening Bracket Screw (2). Loosen adjustment knobs and aim lamp heads.
8. Turn on electricity at fuse or circuit breaker box and test if the unit is installed successfully.
9. Place a small streak of silicone caulk on the edge of the fixture bracket, except at the bracket's lower edge. Place the bracket at the fixture so the bracket connecting screw protrudes out of the hole in the fixture bracket. Make sure the fixture is oriented right side up and not upside down on the mounting surface. Confirm that the caulking sealant is completely around the edge of the fixture bracket where it meets the surface of the wall (There should be no caulking at the lower edge of the bracket). Use the bracket securing nut with Rubber Washer (3) to tighten up the bracket to the wall. If the fixture bracket is not tight against the wall, you may need to adjust the two nuts that are in the bracket connecting screw. Make sure the unit is tight and secure against the wall.

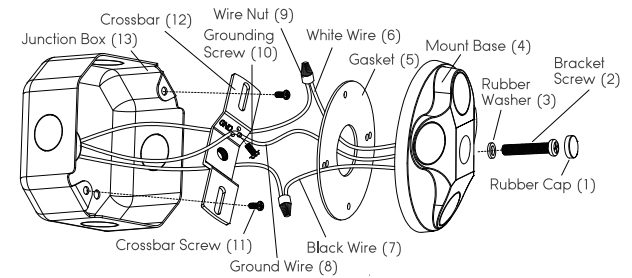

1. MOUNTING THE CROSSBAR TO A JUNCTION BOX (NOT INCLUDED).

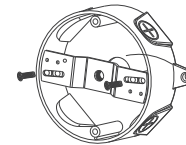

2. WIRING THE LIGHT FIXTURE.

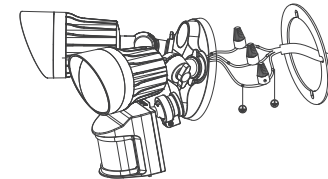

3. MOUNTING THE LIGHT FIXTURE.

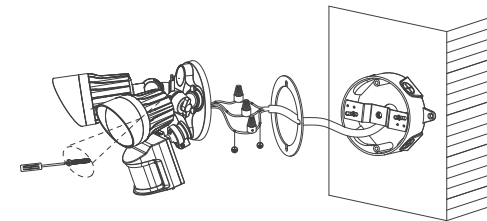

4. CAULKING AROUND THE LIGHT FIXTURE.

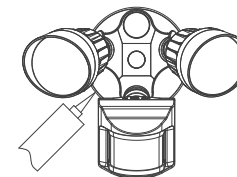

03 / OPERATION GUIDE

3 Knobs:

By turning the 3 knobs on the right side, 3 kinds of settings can be adjusted as follows:

Lux Knob: The sensitivity of the photo sensor is changeable (0- ∞ lux), turn the first knob clockwise, the light sensitivity will rise and vice versa.

Time Knob: Lasting time of the light is changeable (5s-5mins), turn the second knob clockwise to raise the delay time and vice versa.

Range Knob: The max distance of the motion sensor is changeable (20-59ft) , turn the third knob clockwise and the detection distance will increase and vice versa.

3 Modes:

3 lighting modes are available by slipping the arrow of the 3-way switch on the left side.

ON-TIME Mode - The light will be on after you switch it on like a normal light bulb.

AUTO Mode - Turn the Lux Knob counterclockwise until max. This light will stay off during the day and will turn on at night when motion is detected. After a certain set amount of time (set by you) , the light will turn off when no motion is detected.

Please note that by turning the Lux Knob clockwise, the sensor will detect motion earlier in the day. At the max setting, it will turn on when motion is detected, even during the day.

Dusk-to-Dawn Mode - Turn the three knobs counterclockwise until the lowest setting is reached and then slip the switch to D2D mode, this puts the light into dusk-to-dawn mode. At night, the light will turn itself on during this mode and will turn off during the day. Please note that by turning the Lux Knob clockwise, the photocell sensitivity will lower and if it goes pass max, the light will stay on no matter what time of day it is.

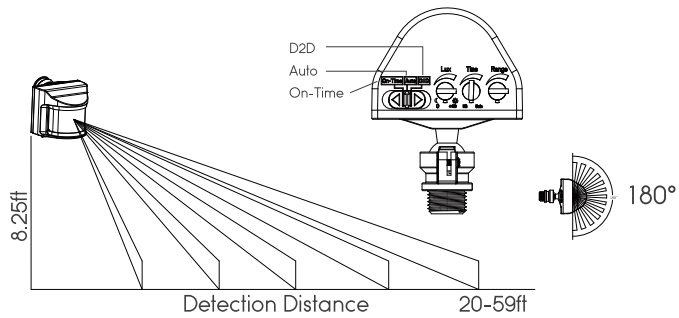

04 / HOW TO USE

Open the rubber cover to adjust the color temperature.

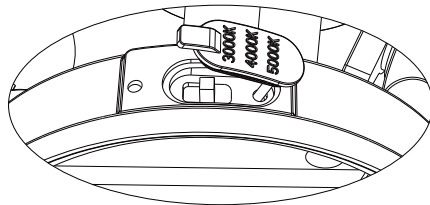

05 / WARRANTY

LeonLite warrants that this product is free from defects in materials and workmanship for a period of 5 years from the day of purchase. This warranty does not apply if the product has been damaged through misuse, abuse, accident, modifications, alterations, neglect or mishandling.