

单页尺寸:120*120mm

TORCHSTAR
LED ILLUMINATION SOLUTION

Shallow New Construction Recessed Housing
User Manual

Unpacking check: PLEASE check and make sure that there are no signs of physical damage or missing accessories to the product when unpacking. DO NOT install damaged products.

01 / WARNING

1. Due to risk of electric shocks, installation of this product requires knowledge of electrical systems, if you are not qualified, DO NOT attempt installation. Contact a qualified electrician in accordance with the National Electrical Code and relevant local code.

2. Before attempting installation, make sure that the ceiling construction follows the requirements as shown in Fig.A.

IC Housing:

Can be installed in direct contact with insulation.

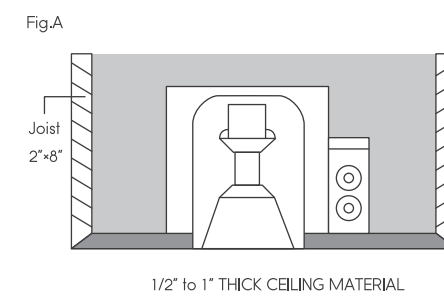

3. PLEASE TURN OFF THE POWER AT THE BREAKER BOX before attempting to install or service.

02 / INSTALLATION INSTRUCTIONS

Bar Hangers

Install the hanger bar to the fixture, be sure that the end tab is facing outwards.(Fig.B)

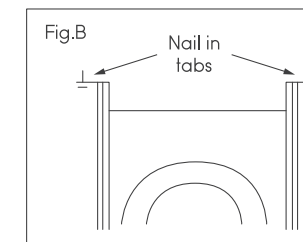

Install Fixture to Ceiling

1. Joists type ceilings: Extend bar hangers to fit between joist and position the fixture. Hammered nail on bars into the joists to secure the fixture. Make sure the bar hanger is leveled with the bottom of the joists. (Fig.C)

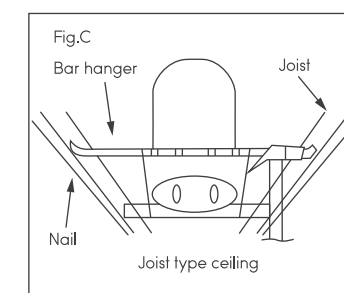

TORCHSTAR

2. T-Bar type ceilings: Extend bar hangers 1" past the T-bars, then rest the fixture on the T-bars. Secure the fixture to T-bars with wire.(Fig.D)

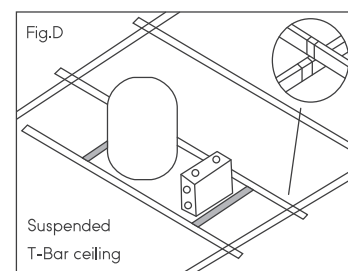

Install LED Trim Kit

Install the trim kit to can, insert the trim into housing, push the housing fully upward and till the pressure springs hold the trim in place.(Fig.E)

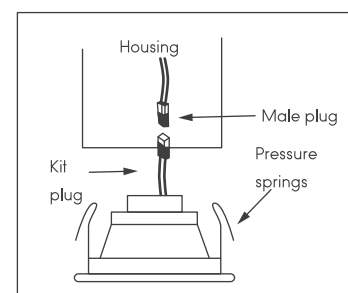

Electrical Connection

1. Most dwellings built before box cover 1985 have supply wire rated at 60°C.(Fig.F), please consult a qualified electrician before installing.

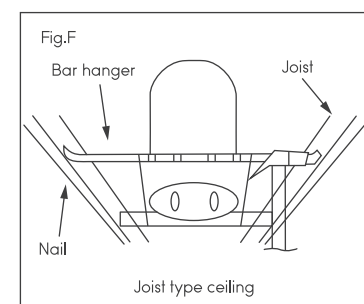

2. Junction box contains three wires: a black (hot) wire, white (neutral) wire and bare ground. **MAKE WIRE CONNECTION ACCORDINGLY: white wire from power supply to white wire from fixture, black wire from power supply to black wire from fixture, bare/green wire from power supply to bare wire from fixture.** (Fig.G)

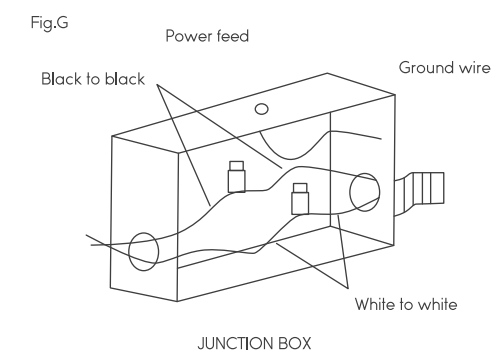

3. After completing the wiring, snap wiring box cover closed (make sure the wires are placed neatly in the junction box).

03 / GROUNDING

FOR Romex or 3-wire BX, flexible armored cable installation, attach supply ground lead to bare copper ground lead or ground screw in junction box. Local electrical codes should be consulted to determine acceptable conduit for the Romex or flexible armored cable.

04 / WARRANTY

TORCHSTAR warrants that this product is free from defects in materials and workmanship for a period of 2 years from the day of purchase. If the product has been misused, damaged by accident or in any other way of improper use, this warranty becomes void.

05 / MANUFACTURER CONTACT INFO

Website: www.torchstar.us
E-mail Address: info@torchstar.us
Phone Number: 800-990-7688