

# 4ft Motion Activated Lighting Fixture

## User Manual

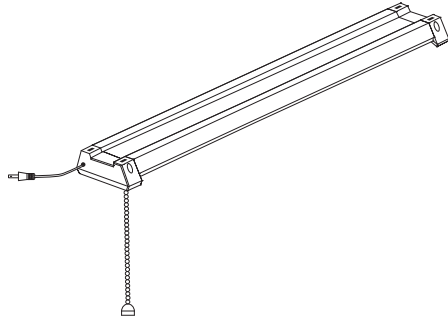

READ ALL THE INSTRUCTIONS AND SAVE THIS INSTRUCTION SHEET. IT MAY CAUSE RISK OF FIRE OR PERSONAL INJURY WITHOUT READING THE INSTRUCTIONS.

### 01 / CAUTION

- ONLY use in damp/dry locations.
- DO NOT use with dimmers.
- ONLY use insulated staples or plastic ties to secure the cord.
- Is NOT intended for use in recessed installations or on the ceiling.
- DO NOT install directly over a heat source (stove, etc.).
- Use safety precautions. Safety eye glasses and gloves are recommended.
- The installation should NOT be made on a radiant-heating ceiling.
- Pulling this lamp from the surface may result in injuring people and damage to the lamp and/or the mounting surface. To reduce the likelihood of such injury or damage, mount ONLY on a mechanically sound surface.
- DO NOT alter the plug or power supply cord in any way or try to install this product in any other method besides the method shown in this manual.

#### NOTE:

To install onto a plaster board surface that requires minimum 3/8" thick.

### 02 / PACKAGE CONTENTS

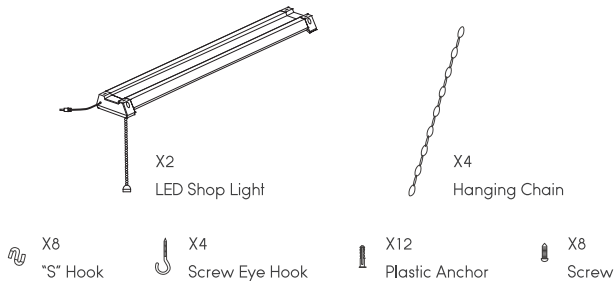

### 03 / INSTALLATION

#### STYLE 1 INSTALLATION INSTRUCTIONS:

1. Mounting surface must be capable of supporting the fixture. If the surface is made of plaster board, we recommend that you use minimum #8 screw eye hooks with plastic anchors (included) or expansion bolts (not included). If installed onto a plaster board surface, we recommend minimum 3/8" thick.

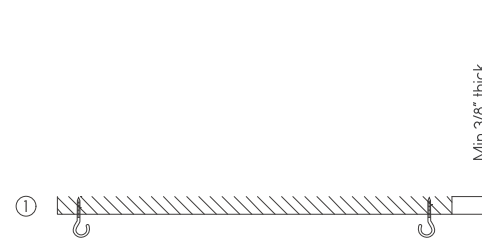

2. Install 2 plastic anchors 47 1/4" apart, then screw the eye hook into each anchor.

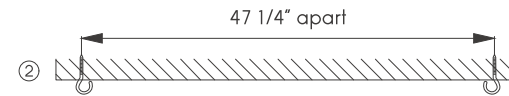

3. Install one "S" hook into each end of the chain, then crimp the "S" hook end which is attached to the chain with pliers. (Leave one side open from the "S" hook) Repeat step for the second chain provided.

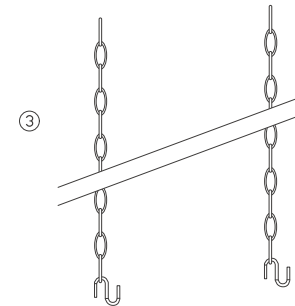

4. Install the "S" hook from one end of the chain into the end cap of the LED lamp, then crimp the hooks end with pliers. Repeat the same step for the opposite side.

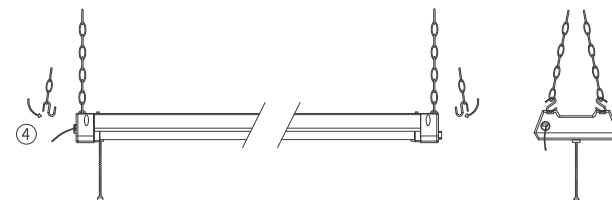

5. Install the LED lamp with chains, one end at a time onto each screw eye hook. Once installed, crimp each of the "S" hooks' ends with pliers.

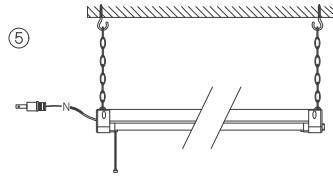

6. Plug the power supply cord into the electrical outlet.

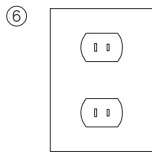

**STYLE 2 INSTALLATION INSTRUCTIONS:**

1. Mounting surface must be capable of supporting the fixture. If the surface is made of plaster board, we recommend that you use minimum #8 screw eye hooks with plastic anchors or expansion bolts (not included). If installed onto a plaster board surface, we recommend minimum 3/8" thick.

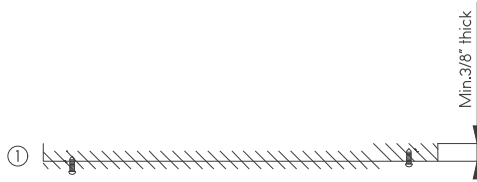

2. Install the 4 plastic anchors 46 1/2" apart and 3.189" apart, then screw the eye hook into each anchor. Spacing between ceiling and cap nut should be at least 1/3".

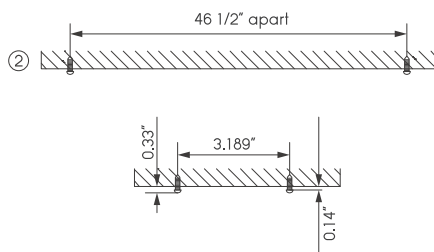

3. Lift fixture up to screws and slide to one side to secure into place. Screw size: ST4X30.

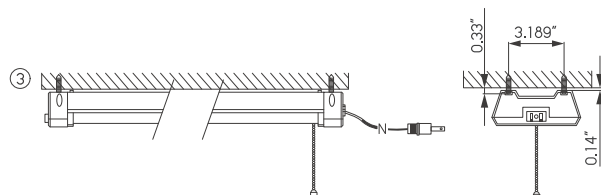

4. Plug the power supply cord into the electrical outlet.

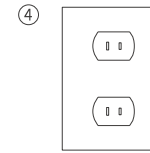

**LINKING MULTIPLE SHOP LIGHTS**

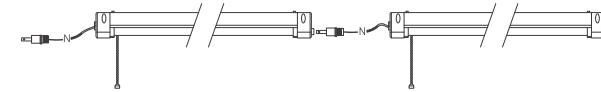

Connect to Power Outlet    Connect to additional shop light    Link up to 4 shop lights together

**O4 / WARRANTY**

LEONLITE warrants that this product is free from defects in materials and workmanship for a period of 3 years from the day of purchase. If the product has been misused, damaged by accident or in any other way of improper use, this warranty becomes void.