

LED Canopy Light

User Manual

01 / WARNING

- THE LED CANOPY LIGHT MUST BE INSTALLED IN ACCORDANCE WITH ALL APPLICABLE ELECTRICAL CODES BY PERSONS FAMILIAR WITH THE INSTALLATION, OPERATION, AND/OR MAINTENANCE OF THE PRODUCTS AND THE HAZARDS INVOLVED.
- THE LED CANOPY LIGHT MUST BE INSTALLED WITH UL LISTED LIQUID-TIGHT CONDUIT FITTINGS.
- Risk of fire or electric shock.
- Make sure the working voltage of LED canopy light is under its rated voltage.
- Make sure the accessories and wires are completed and intact during the installation.
- Installation requires knowledge of electrical systems. For install by qualified electrician only. Do not attempt installation if not qualified.
- This fixture should only be installed in place of existing luminaries that have the construction features and dimensions specified in this manual.
- Do not expose any wire to edge of sheet metal and/or other sharp objects that may cause damage or abrasion.
- Do not change existing open holes or create any additional open holes in the fixture or its components during installation.

02 / CAUTION

- Be certain electrical power is OFF before and during installation and maintenance.
- To prevent wiring damage or abrasion, do not expose wiring to edges of sheet metal or other sharp objects.
- Do not use the LED Canopy Light near heating appliances/ elements.
- The input voltage and lamps should be matched after connecting the power line. please make sure the wiring section is insulated.
- LED Canopy Light must be operated within an ambient temperature range of -22 - 104 F . LED Canopy Light is not intended for use with emergency exits.
- The Installation must be carried out by a qualified electrician.

03 / INSTALLATION

1. Loosen the screw to take off the mounting plate from the lamp.

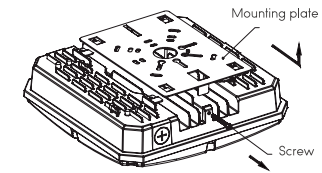

2. Use screws to lock the mounting plate on the embedded junction box.

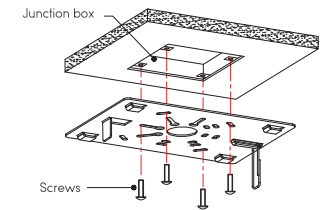

3. Hang the lamp on the ring so as to connect wires with terminal caps.

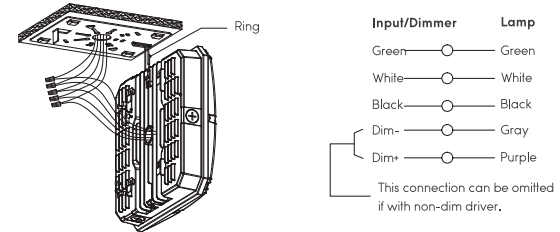

4. Hook up lamp on the mounting plate.

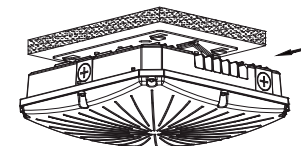

5. Secure the screw. Installation completed.

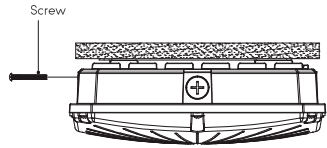

Pole-pendent Installation

1. Connect wires with terminal caps as picture shows.

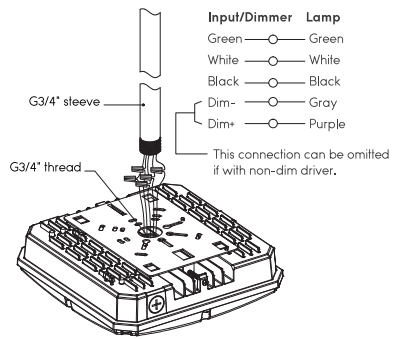

2. Rotate the sleeve to make it fixed with lamp. Installation is completed.

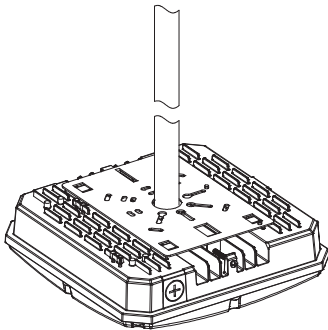

O4 / WARRANTY

LEONLITE warrants that this product is free from defects in materials and workmanship for a period of 5 years from the day of purchase. If the product has been misused, damaged by accident or in any other way of improper use, this warranty becomes void.

LeonLite