



Ultra-Thin
Smart LED Recessed Light
User Manual

Thank you for choosing TORCHSTAR as your home smart lighting solution! Please follow the instructions to ensure the product functions safely and properly for years to come. We hope to keep providing pleasure and enjoyment for your home!

SUPPORT

- Please contact us at info@torchstar.us or call +1 (800) 990-7688



Scan the QR code to download LITEdge App.

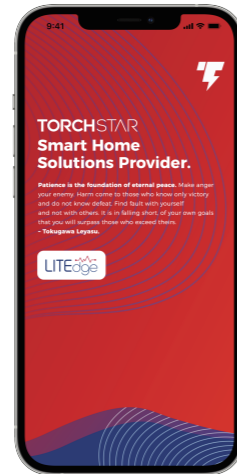

IMPORTANT SAFETY INSTRUCTIONS

01 / WARNING

READ ALL INSTRUCTIONS AND SAFETY INFORMATION BEFORE USE. SMALL PARTS MAY POSE CHOKING HAZARDS. KEEP DEVICE AND BOX CONTENTS OUT OF REACH OF CHILDREN.

RISK OF FIRE OR ELECTRIC SHOCK. BEFORE TOUCHING ANY WIRE, USE A VOLTAGE TESTER TO MAKE SURE IT'S NOT LIVE.

DO NOT USE WHERE DIRECTLY EXPOSED TO WATER OR WEATHER. TOUCH A PLUG ONLY BY ITS INSULATED RIM. USE TOOLS WITH INSULATED HANDLES.

DISCONNECT MAIN POWER AT FUSE OR CIRCUIT BREAKER BEFORE INSTALLING OR SERVICING THE FIXTURE.

MEET OR EXCEED ALL ELECTRICAL CODE REQUIREMENTS THAT COVER THE WORK YOU ARE DOING.

02 / CERTIFIED

- ETL listed
- Energy Star
- Wet location rated
- IC-rated for direct contact with insulation

03 / DIMMING

This light is NOT compatible with regular dimmer switches. Please download the App and connect the light with the App for full dimming control.

04 / RADIATION EXPOSURE STATEMENT

Any changes or modifications not expressly approved by the party responsible for compliance could void the user's authority to operate this equipment. This transmitter must not be co-located or operated in conjunction with any other antenna or transmitter. This equipment should be installed and operated with a minimum distance of 8 inch (20 CM) between the radiator and your body.

The manufacturer is not responsible for any radio or TV interference caused by unauthorized modifications or changes to this equipment. Such modifications or changes could void the user's authority to operate the equipment.

This equipment generates, uses and can radiate radio frequency energy and, if not installed and used in accordance with the instructions, may cause harmful interference to radio communications. However, there is no guarantee that interference will not occur in a particular installation.

If this equipment does cause harmful interference to radio or television, which can be determined by turning the equipment off and on, the user is encouraged to try to correct the interference by one or more of the following measures:

- Reorient or relocate the receiving antenna.
- Increase the separation between the equipment and receiver.
- Connect the equipment into an outlet on a circuit different from that to which the receiver is connected.
- Consult the dealer or an experienced radio/TV technician for help.

ULTRA-THIN SMART LED RECESSED LIGHT

01 / LIMITED WARRANTY

The manufacture warrants the product to be free from defects in materials and workmanship for five (5) years from the day of purchase when used as directed. Failure to comply with product warning shall void the warranty. This warranty does not cover product subject to accident, neglect, abuse, misuse, or acts of God. If product fails to operate according to the warranty, the manufacturer will replace product with the same or similar product, at no charge. LABOR IS NOT INCLUDED. Product should be returned, together with proof of date of purchase, to the company. This is the exclusive remedy available. Due to liability for incidental or consequential damages, the above limitation or exclusion may not apply to you. This warranty gives you specific legal rights, and you may also have other rights that vary from state to state.

For more information about TORCHSTAR warranty, please contact us by:

www.torchstar.us/contacts

+1 (800) 990-7688

02 / RECYCLING AND ENVIRONMENT PROTECTION

Recycling helps protect the environment. ♻️

Recycling reduces the need for extracting (mining, quarrying and logging), refining and processing raw materials all of which create substantial air and water pollution. As recycling saves energy it also reduces greenhouse gas emissions, which helps to tackle climate change.

Make sure you recycle or dispose your device in accordance with your local laws and regulation.

03 / OPERATION REQUIREMENTS

Constant power to the product is required at all times.

Ultra-Thin Smart LED Recessed Light installation requires knowledge of luminaires electrical system. If not qualified, do not attempt installation. Contact a qualified electrician. All electrical connections must be in accordance with local and National Electrical Code (N.E.C) standards.

DO NOT make or alter any open holes in an enclosed wiring or electrical components during fixture installation.

To prevent wiring damage or abrasion, DO NOT expose wiring to edges of sheet metal or other sharp objects.

This fixture is not intended for use with emergency exit fixtures or emergency exit lights.

DO NOT USE WITH REGULAR WALL DIMMERS. Product is NOT suitable for use with traditional wall dimmers, dim via app only.

Only install in operating environments between -13°F and 113°F (-25°C and +45°C).

Model Diameter	Line Power Standard	Luminous Flux	Power Consumption	Color Temp/Light Color	Color Rendering Index
4"	120V 60Hz, AC ONLY	550lm	8W	RGB+CCT	CRI>90
6"	120V 60Hz, AC ONLY	700lm	12W	RGB+CCT	CRI>90

PACKAGE CONTENTS

Before beginning installation of this product, make sure all parts are present. Compare parts with package contents list. If any part is missing or damaged, DO NOT attempt to assemble, install or operate this product.

Ultra-thin smart LED recessed light x 1

Wire nuts x 3

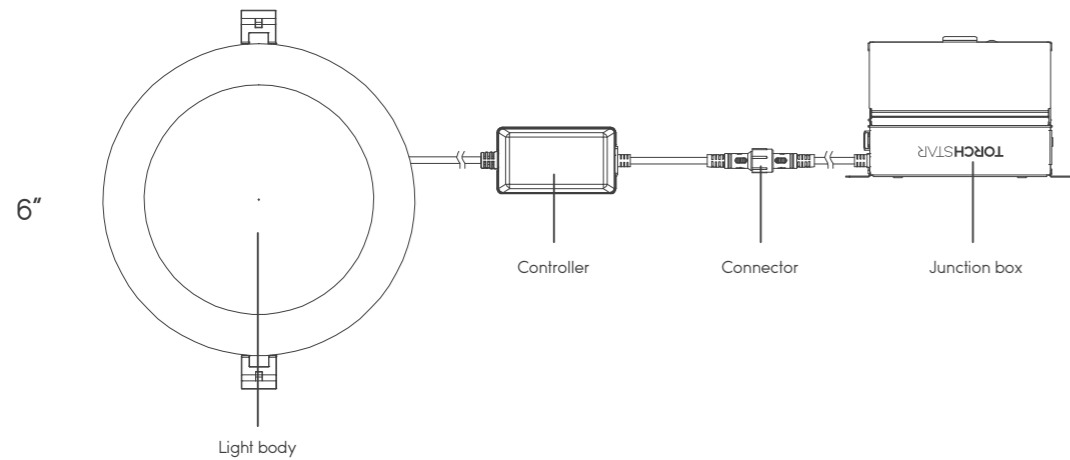
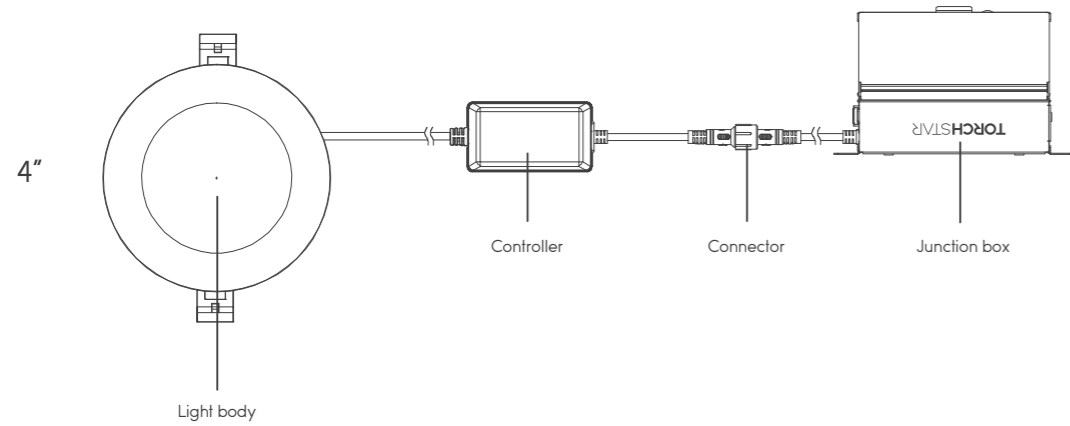

PRODUCT INSTALLTION

1. Turn OFF the power before installing.

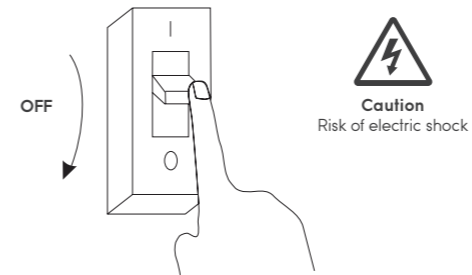

(To prevent electric shock, insulated gloves are recommended during the installation process.)

2. Determine the location for installation and cut the ceiling hole in accordance with cut-hole dimensions. Refer to Hole Diameter table for the appropriate size or use the supplied template.

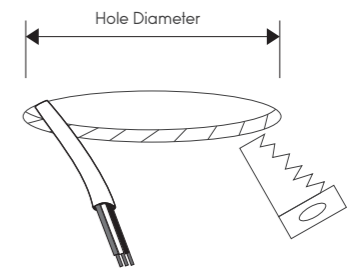

Model	Hole Diameter
4"	4 1/4" (108mm)
6"	6 3/8" (162mm)

3. Open the junction box cover and remove the appropriate knockout(s) on the side panel. Insert the electrical supply cable through the knockout.

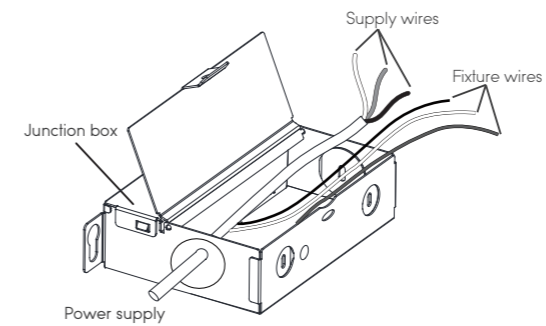

4. Using wire nuts, connect the fixture wires with the supply wires. Connect the black wire to the live wire, the white wire to the neutral wire, and the green wire to the ground wire.

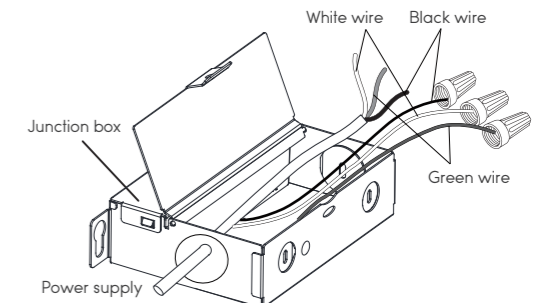

Hot Wire/Line: Black or Red
Neutral Wire: White or Grey
Ground Wire: Green or Bare Copper
Consult your electrician technician if you have questions regarding wire and termination match.

5. Place all wiring connections back into the box and close the cover. Plug the connector cable from the junction box into the light panel and secure with screw cover. Insert junction box through the mounting hole.

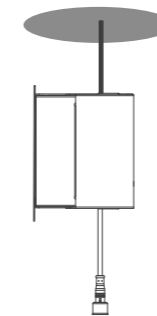

6. Push up on the spring clips and place the light in the ceiling. Release the clips and the light will be pulled flush with the ceiling. The installation is now complete. NOTE: For airtight requirements ensure foam gasket remains between fixture and ceiling (DO NOT remove).

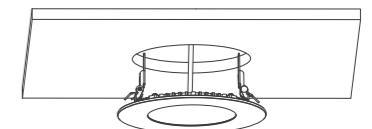

4" HOLE DIAMETER

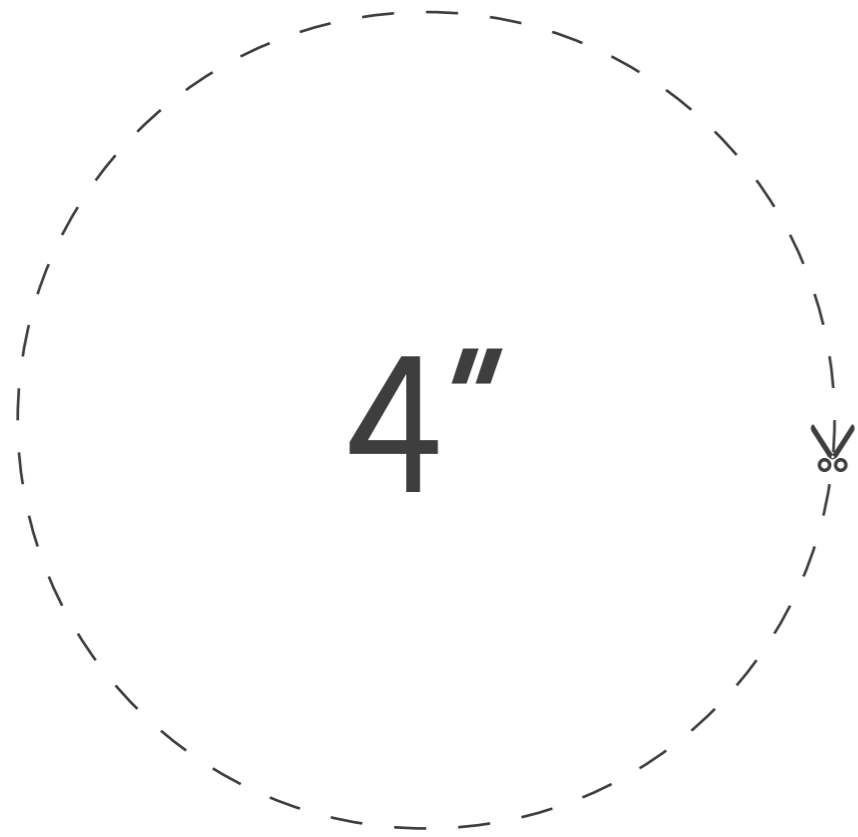

4 1/4" (108mm)

6" HOLE DIAMETER

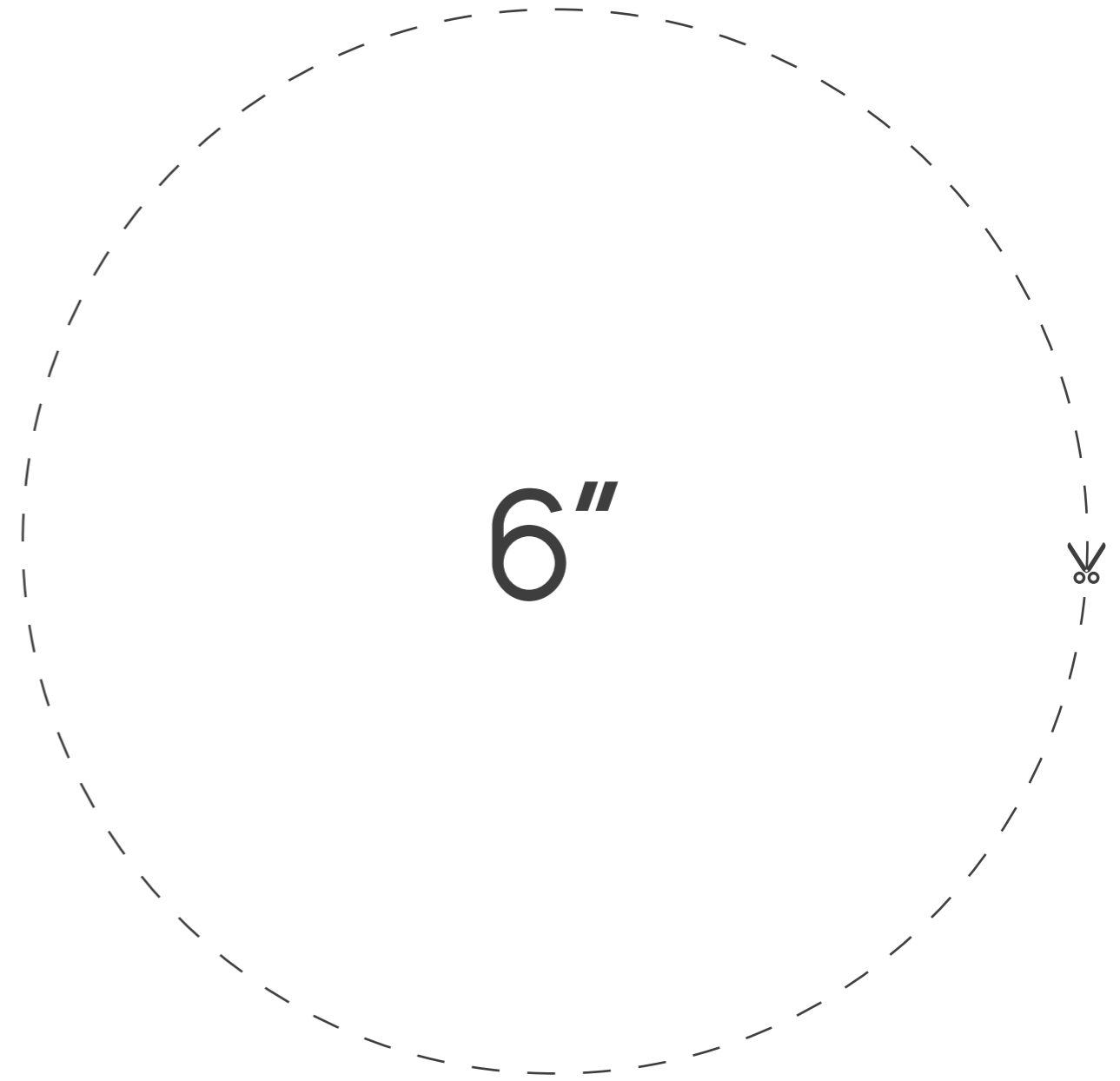

6 3/8" (162mm)

TORCHSTAR