

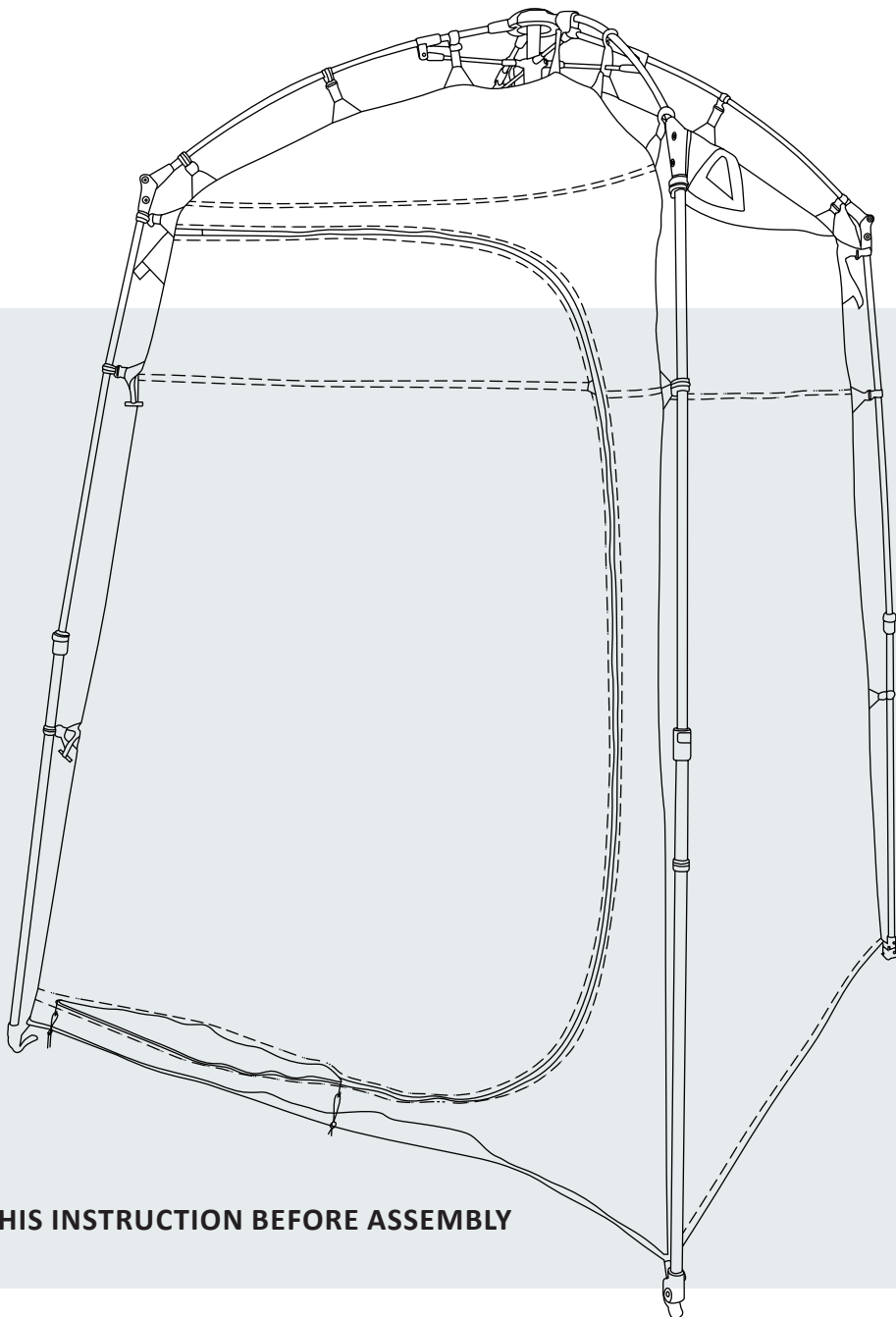

Pop-up Changing Room assembly instructions



PLEASE READ THIS INSTRUCTION BEFORE ASSEMBLY

ASSEMBLY

1. Lay changing room flat on floor with center pointing upward. Then bring arms out till the top is formed.

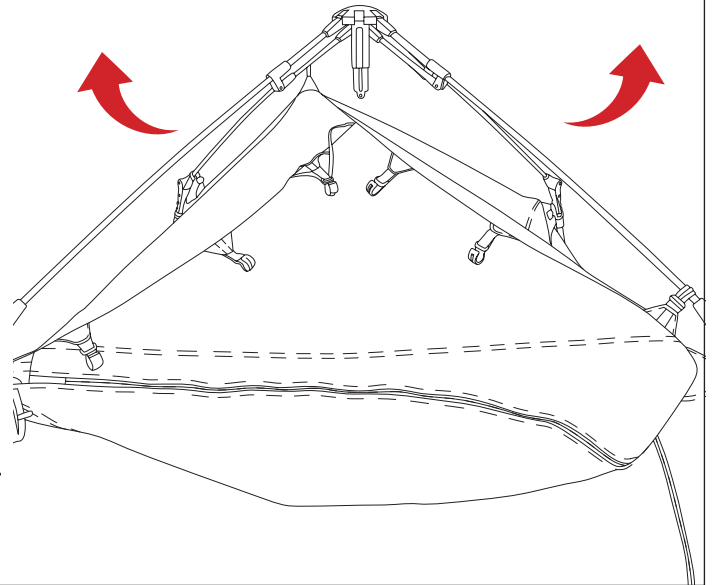
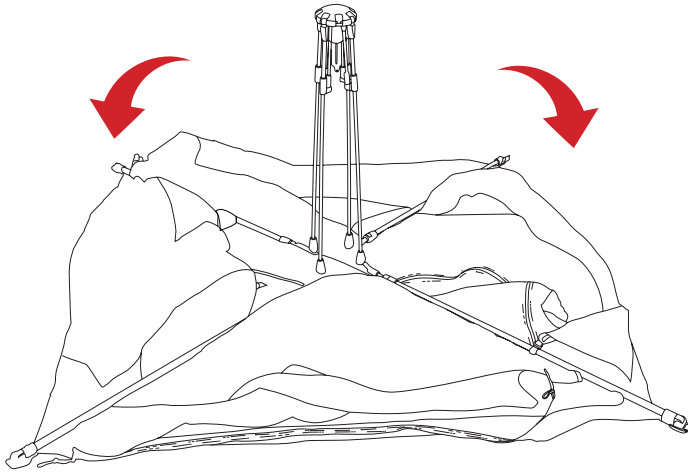

2. Pull hub together make sure that it locks.

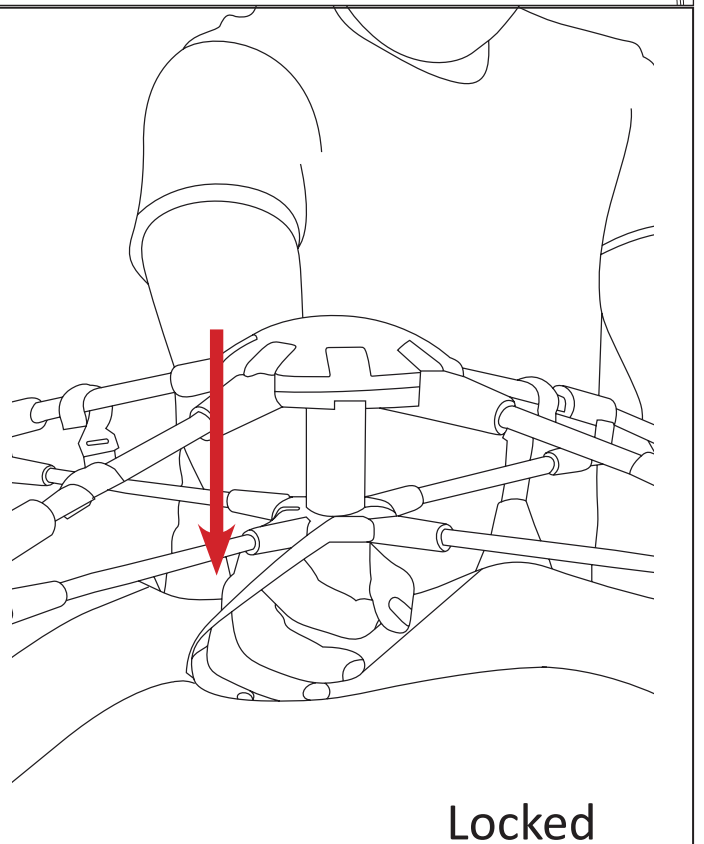
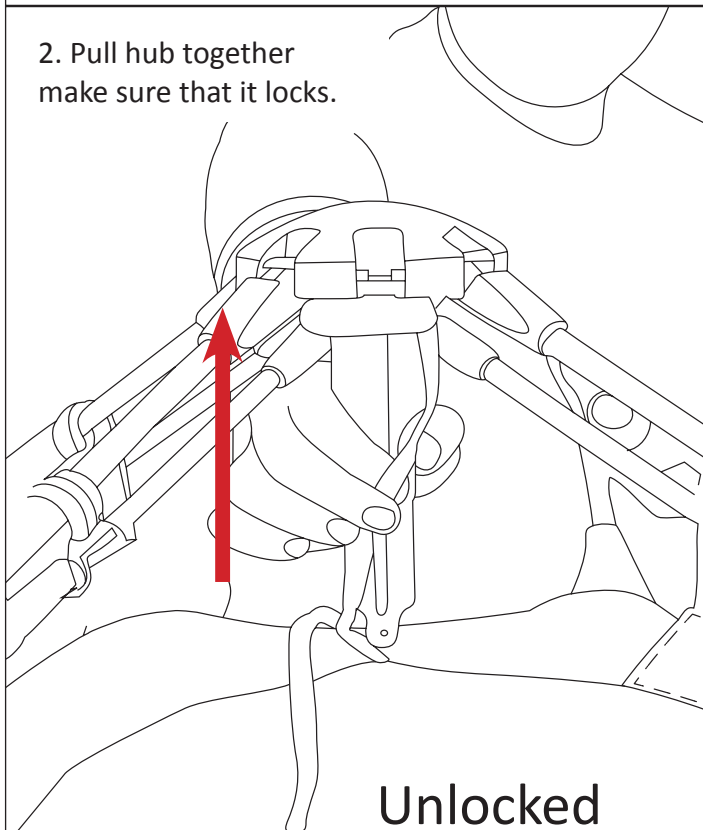

3. Tie loop under hub.

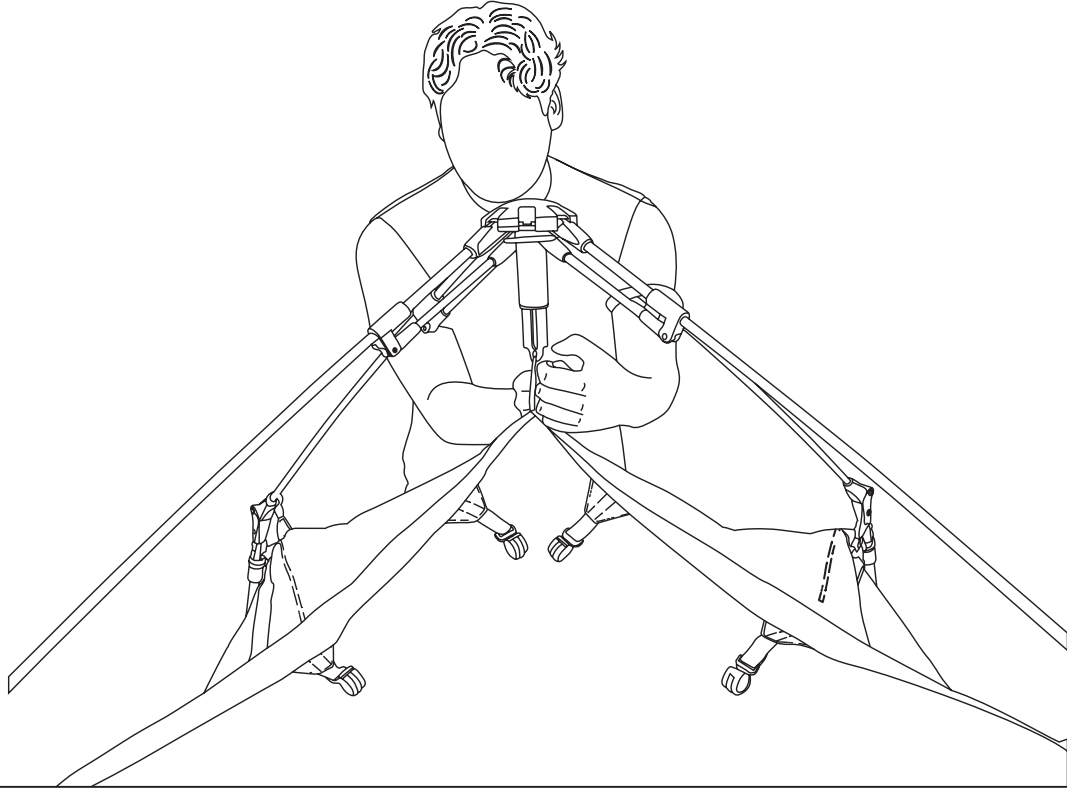

4. Expand telescoping legs and click to secure.

5. Clip fabric to tent frame.

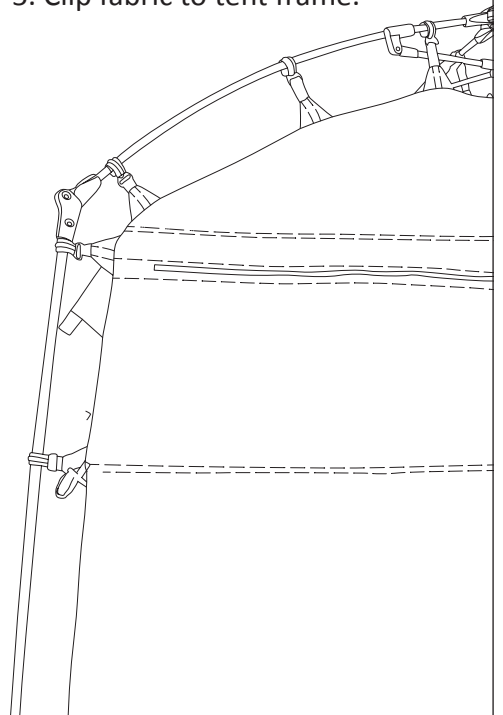
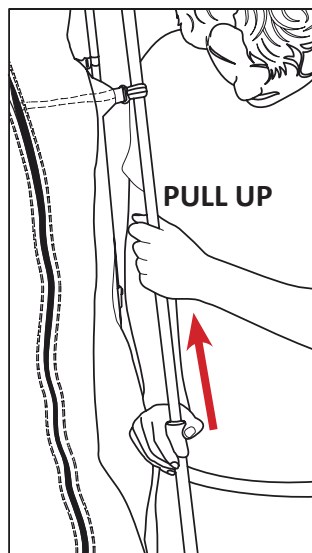
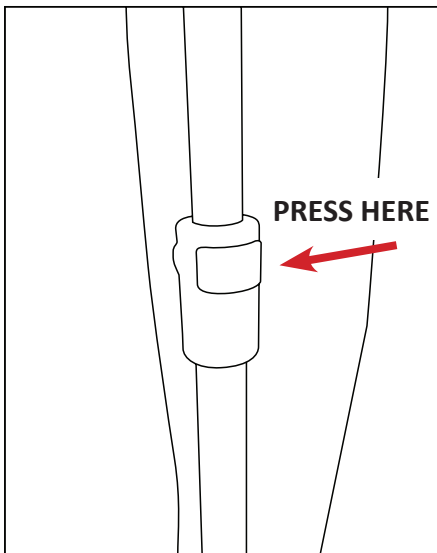

POP-UP CHANGING ROOM

SET-UP & CARE INSTRUCTIONS

Full Kit: 26019910

6. Use provided stakes, then secure the shower with guide ropes.

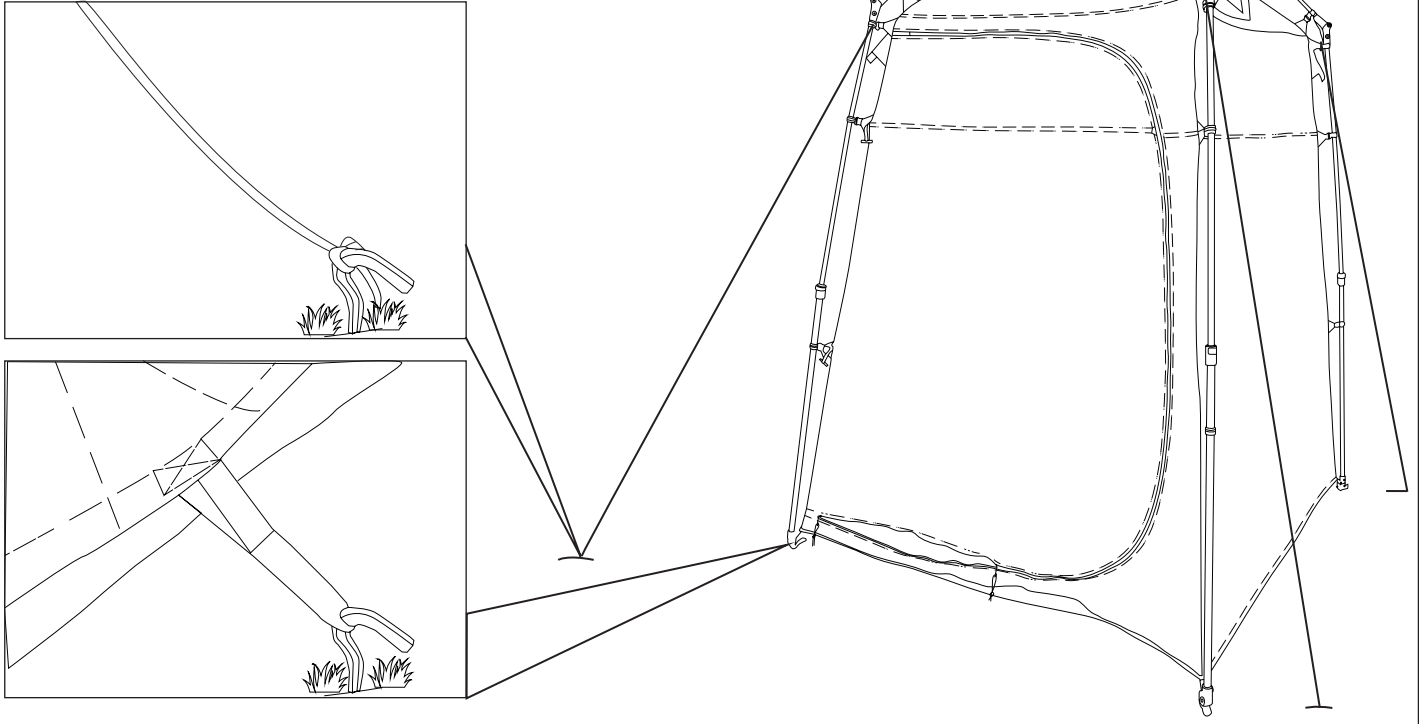

7. Set up Solar Shower by first attaching the hose to the shower spigot with provided zip tie, then trim as needed.

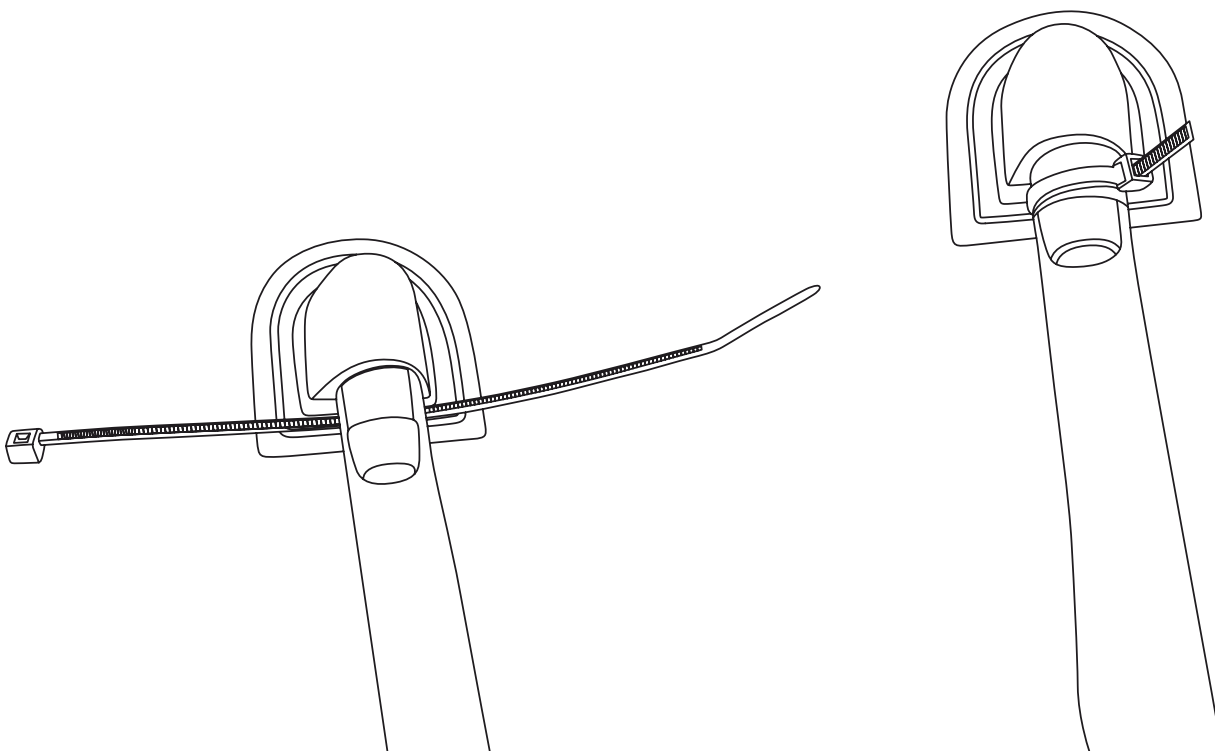

POP-UP CHANGING ROOM

SET-UP & CARE INSTRUCTIONS

Full Kit: 26019910

8. Secure nozzle so that water does not pour out when filling with water.

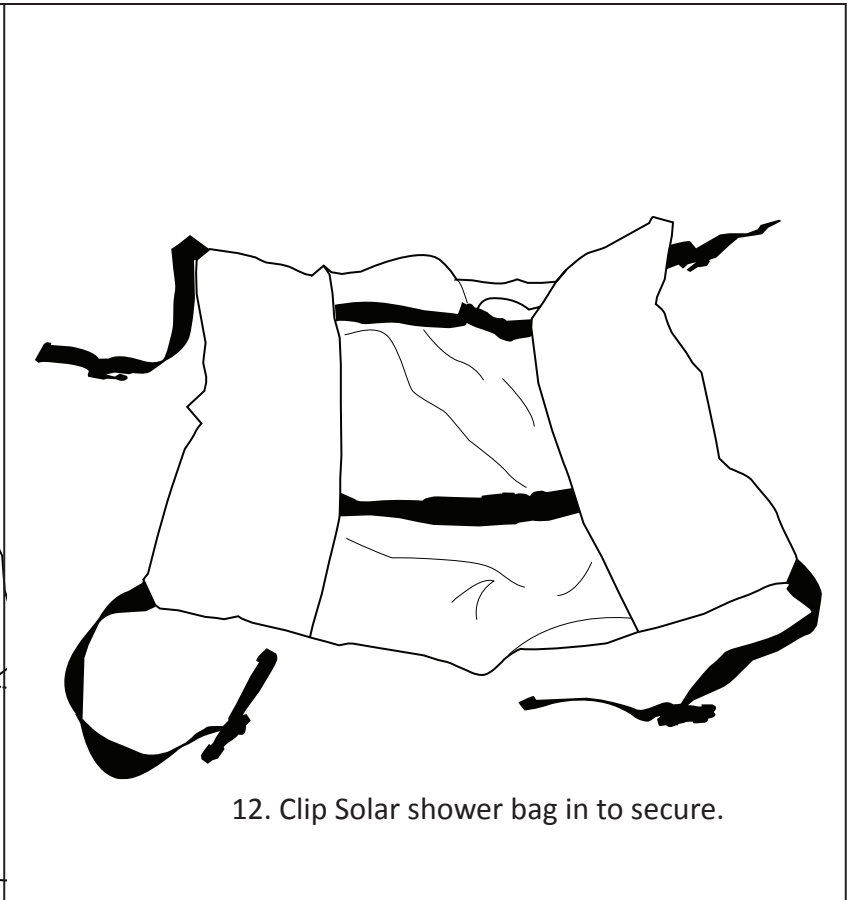
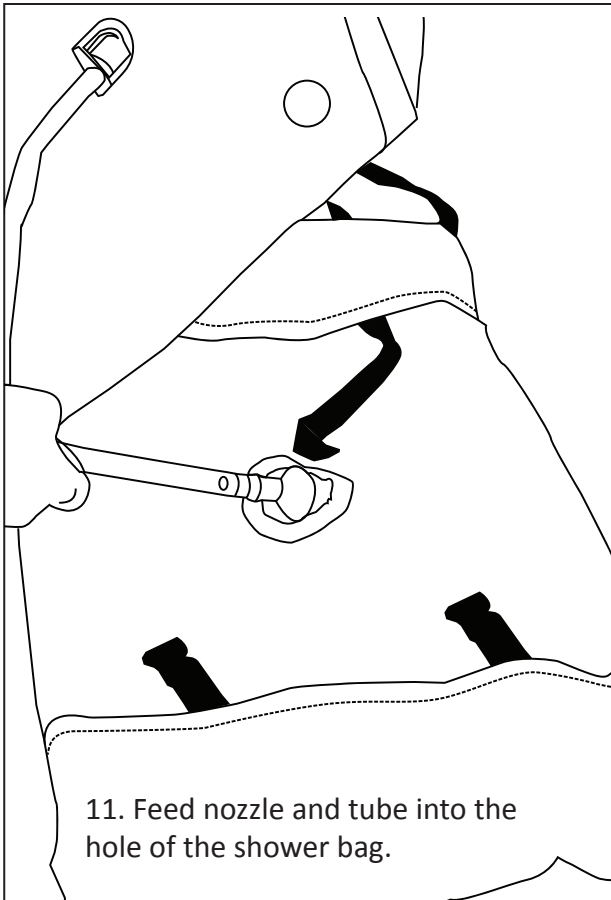
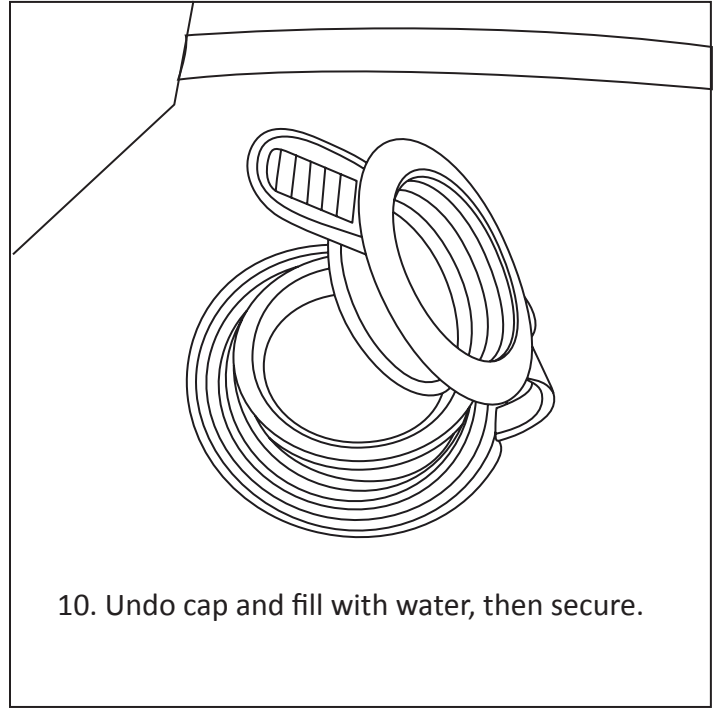
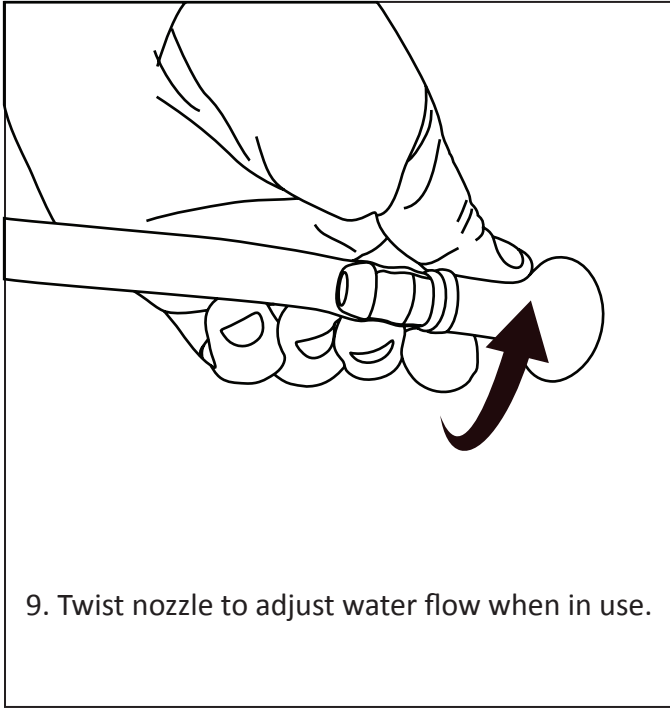

13. Clip in and secure shower bag using the 4 clips on the roof of the shower.

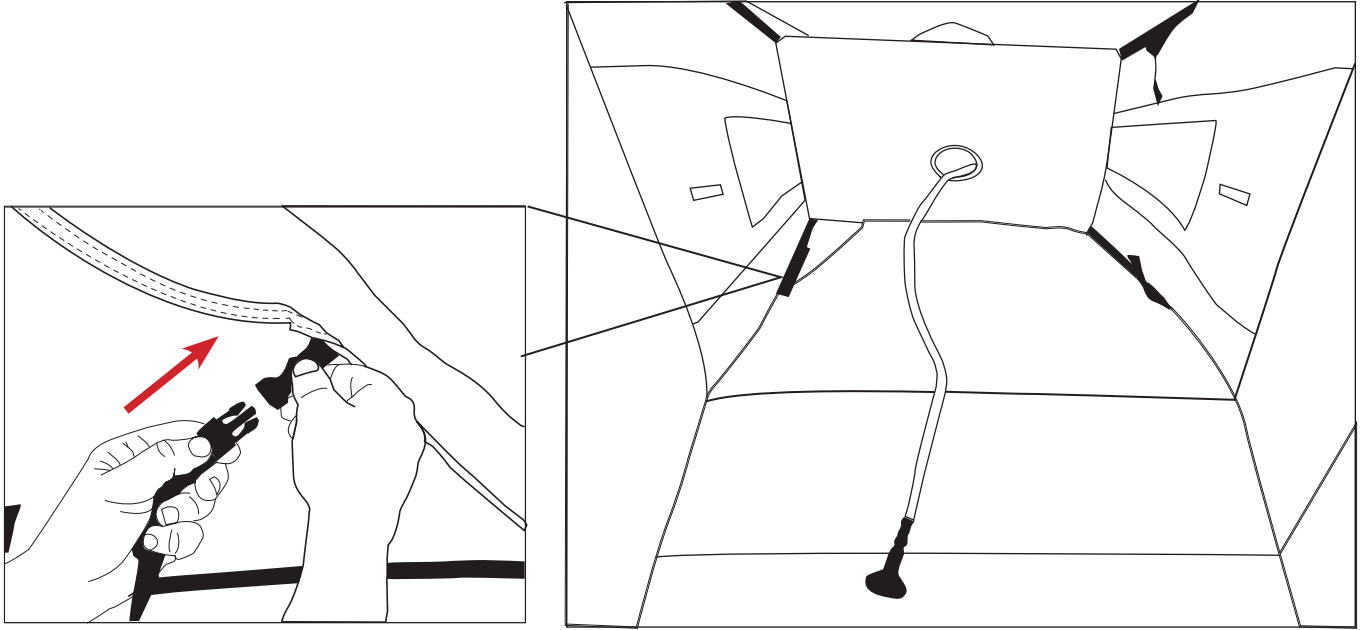

TAKE DOWN

1. Unhook the shower bag, drain any remaining water and store in carrying bag.

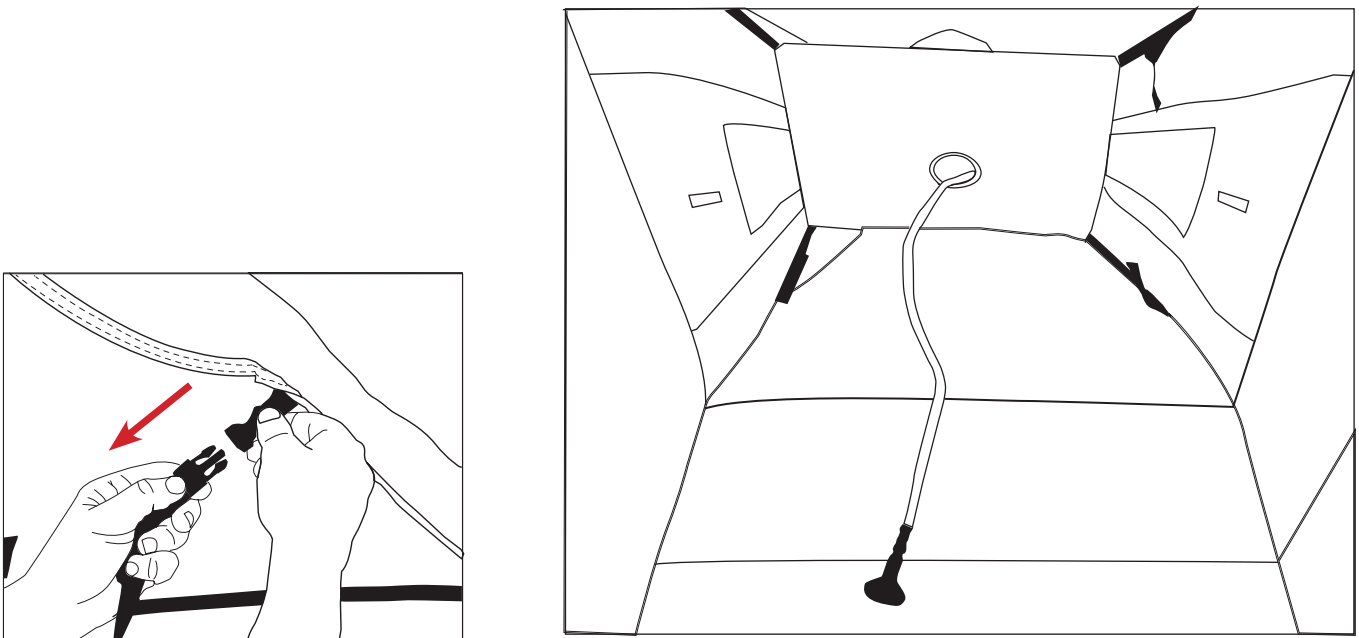

POP-UP CHANGING ROOM

SET-UP & CARE INSTRUCTIONS

Full Kit: 26019910

2. Remove stakes and guide ropes. Unclip tent fabric and collapse the telescoping legs.

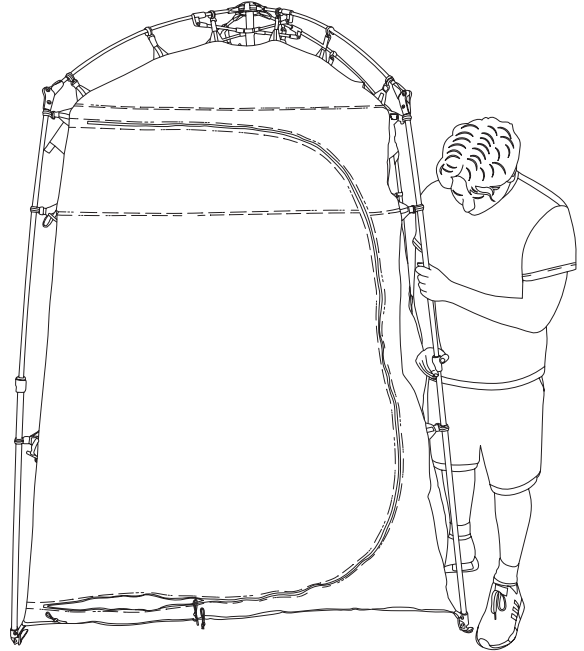
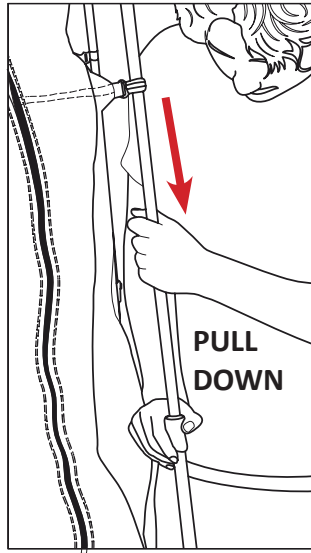
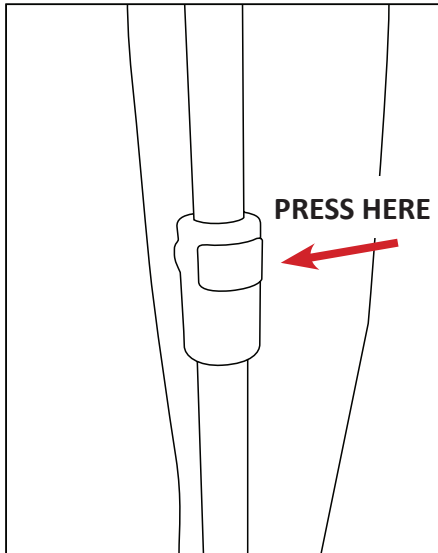

3. Unfasten loop under hub.

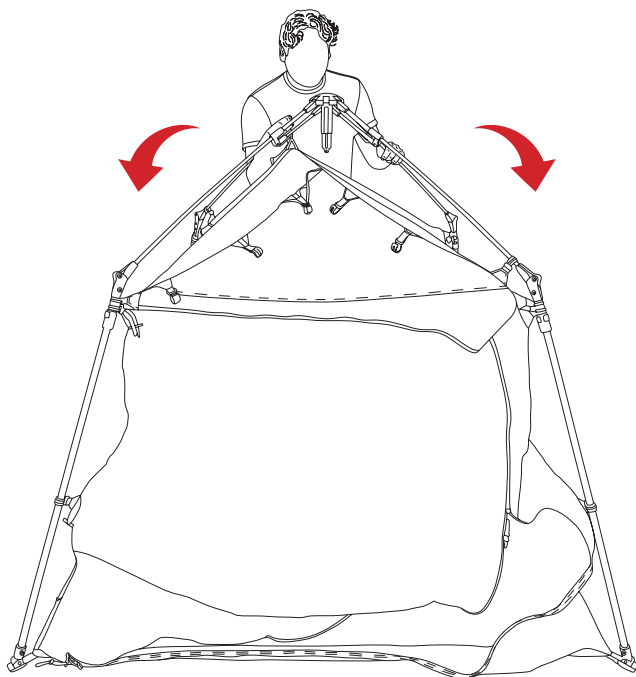

4. Unlock hub.

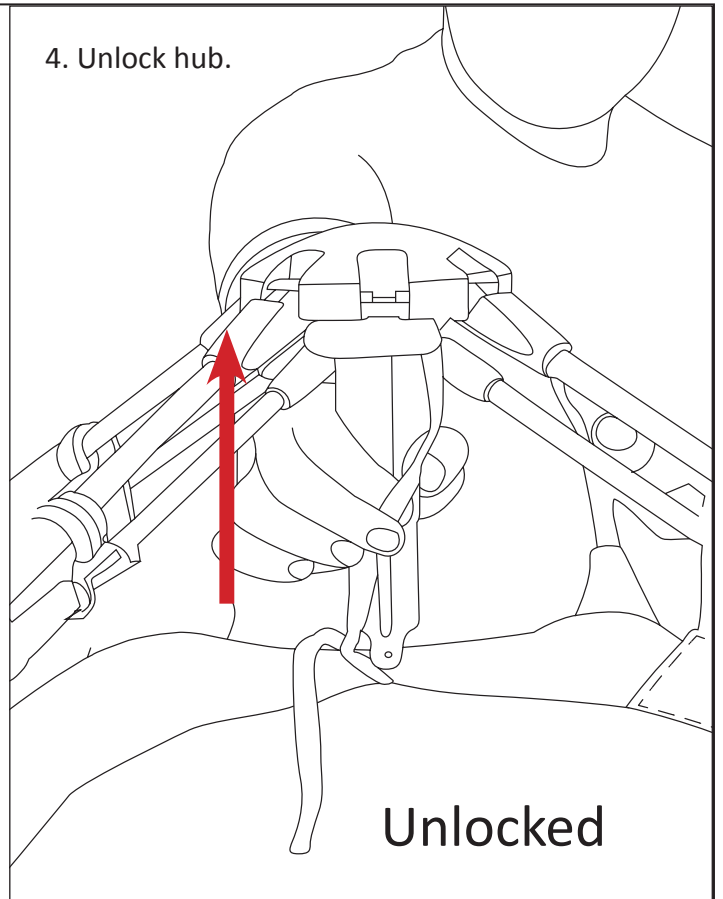

5. Lay fabric corners inward to the center pole.

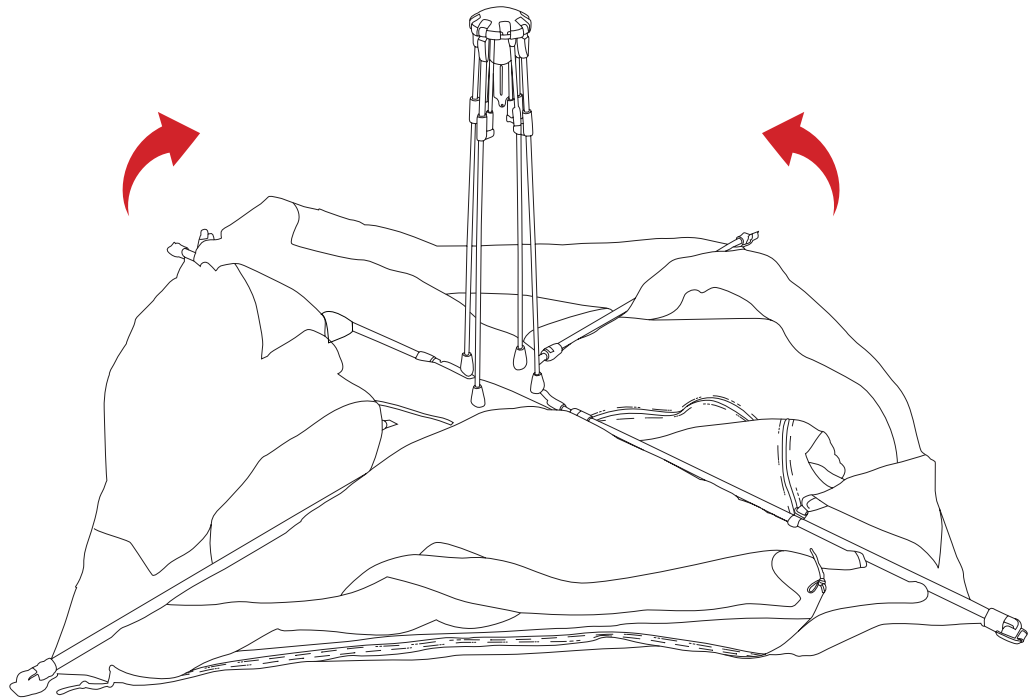

HOW TO FOLD UP

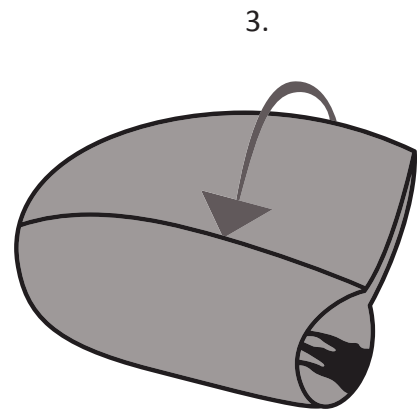
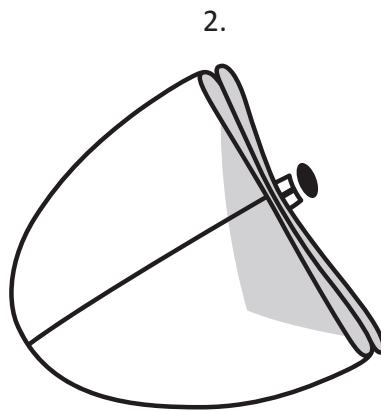

1. Fold all corners inward
2. Lay fabric flat
3. Fold fabric over
4. Store in bag

PARTS AND ACCESSORIES:

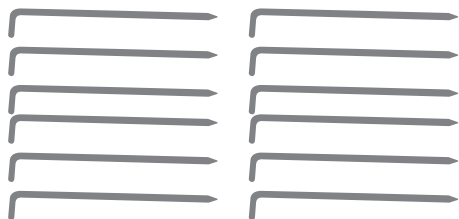

A



B

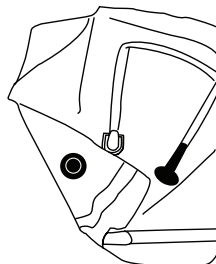

C

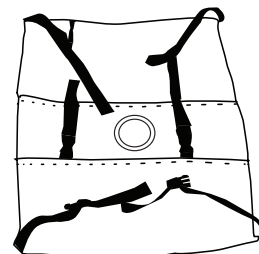

D



E



F

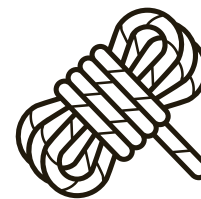

G



H

- A- SHOWER STAKE X12
- B- DRAWSTRING BAG X1
- C- SOLAR SHOWER X1
- D- SHOWER BAG X1
- E- ZIP TIE X1
- F- NYLON STRAPS X2
- G- GUIDE ROPES X4
- H- TRANSPORT BAG X1

+ In a moving vehicle, always store the Pop-Up Changing room inside its traveling bag on the floor of the vehicle, either behind the 1st row of seats or behind the 2nd row of seats.



DO YOU NEED OUR HELP?



CUSTOMER SUPPORT 833-226-4863



SALES@OVERLANDVEHICLESYSTEMS.COM

WANT TO SHOW US YOUR RIG?
CHECK OUT OUR SOCIAL!

@overlandvehiclesystems

