



Thank you for purchasing our product. Before installing/operating the product, read the instructions carefully and retain them for future reference.

⚠ Attention!

- For installation, follow the steps described. Any damage caused by wrong installation shall be imputed to the users.
- To avoid a short circuit from occurring do not pull or modify the wires during installation.
- Do not disassemble or change any parts. Opening and disassembling this unit will void any warranty.
- Maintenance and repairs should be executed by our professionals only.

NOTE

- ⚠ Some procedures must be followed to avoid damages to the product.
- ⚠ **WARNING!** Certain procedure must be followed to avoid damages to yourself, to the vehicle or to others.

1-1 ACCESSORIES

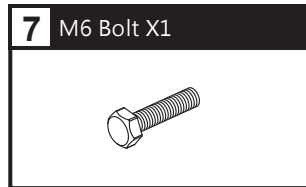
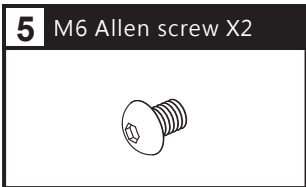
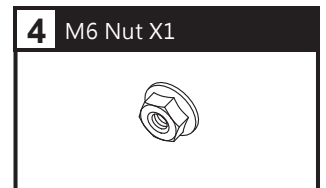
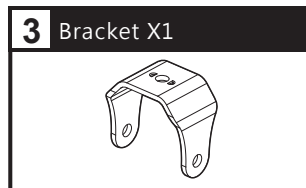
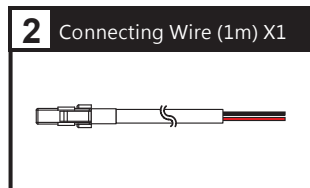
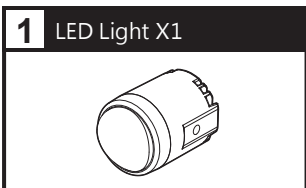

1-2 OPTIONAL ACCESSORIES

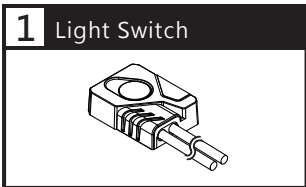

2 SPECIFICATIONS

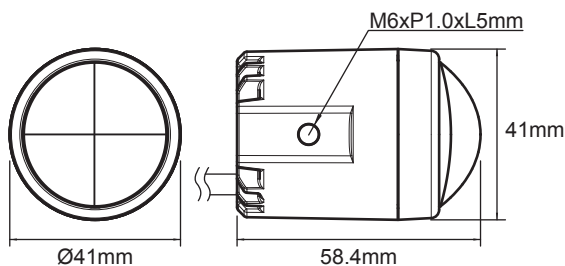

● Module Storage Temp. Range	-10 ~ 60 °C
● Standard	JIS D 0203
● Effective Voltage	DC 10 ~ 16 V
● Current Draw	0.73 ± 0.05 A
● Power	DC 12 / 9.6 W
● Homologation	E-Mark / DOT Approved
● Size	Ø 41 X H 58.4 mm
● Weight	±107 g

NOTE Design and specifications are subject to change without notice.

3 INSTALLATION INSTRUCTIONS

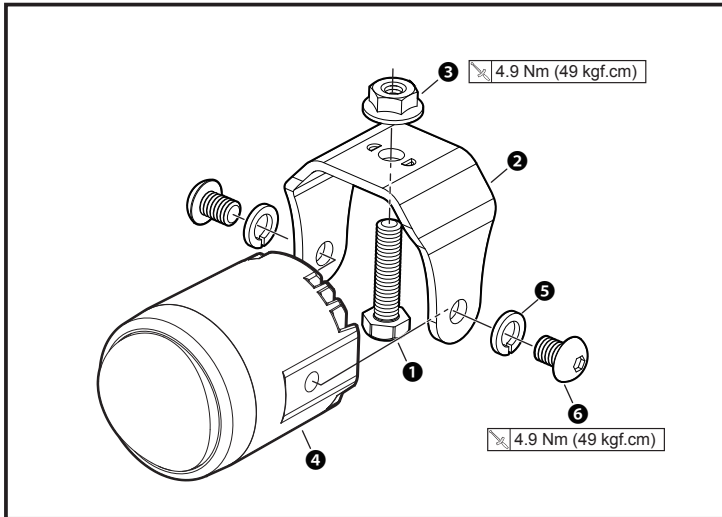

Follow the steps below during installation.

1. M6 Bolt (Accessories 7)
2. Bracket(Accessories 3)
3. M6 Nut(Accessories 4) 4.9 Nm (49 kgf.cm)
4. LED Light(Accessories 1)
5. M6 Lock Washer(Accessories 6)
6. M6 Allen screw(Accessories 5) 4.9 Nm (49 kgf.cm)

4 WIRING INSTALLATION INSTRUCTIONS

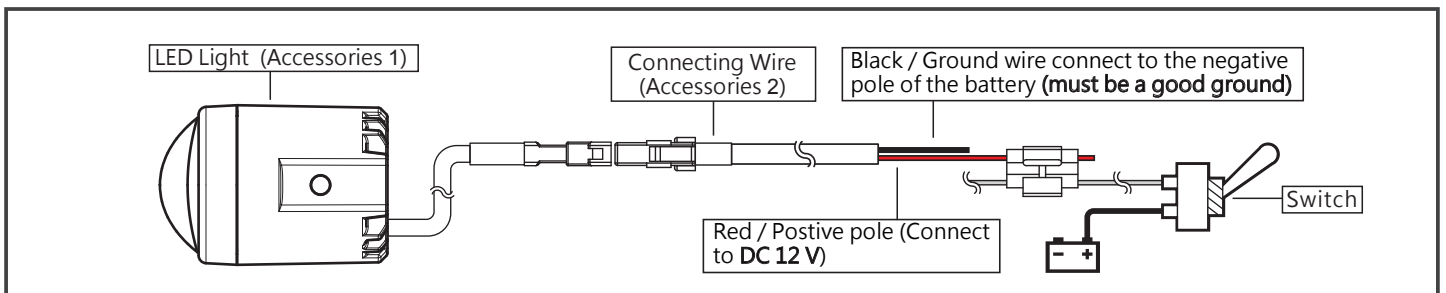

5 TROUBLESHOOTING

The following situations do not indicate malfunctions of the product. Check the following before contacting us.

Trouble	Check item
No LED lighting up.	<ul style="list-style-type: none"> ● Power supply cable may be disconnected. <ul style="list-style-type: none"> → Check if power supply cable is broken or disconnected. → Check if positive and negative poles are properly connected.

※ If the problems still cannot be solved, contact our technical department for assistance.