

False Ceiling HF Sensors

HC009S/EXT HC018V/EXT HC019V/EXT

HYTRONIK®

Applications

Ideally suited to retrofit projects where the luminaire is too small to accommodate the sensor internally, this motion sensor can be completely hidden from view thanks to the penetration properties of microwave sensors. Only a small hole is required to position the daylight sensor.

Total 4 sensors are provided for different applications:

- HC009S/EXT: on/off control version
- HC018V/EXT: tri-level control version
- HC019V/EXT: synchronised control version

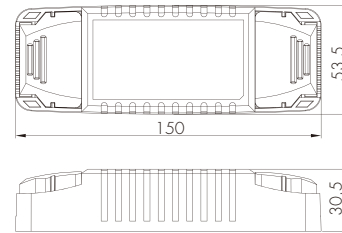
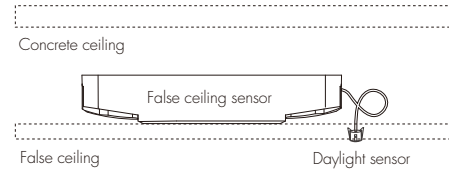

Features

- Zero crossing detection circuit reduces in-rush current and prolongs relay life
- Loop-in and loop-out terminal for efficient installation
- Synchronised control with multiple sensor circuits (HC009S/EXT, HC019V/EXT)
- Tri-level dimming control based upon occupancy (HC018V/EXT, HC019V/EXT)
- 1-10V dimming control method (HC018V/EXT, HC019V/EXT)
- 5 Year, 50,000hr Warranty

Technical Data

Input Characteristics

Model No.	HC009S/EXT
Mains voltage	220~240VAC 50/60Hz
Stand-by power	<0.5W
Switched power:	
Capacitive	400W
Resistive	1200W

Model No.	HC018V/EXT HC019V/EXT
Mains voltage	220~240VAC 50/60Hz
Stand-by power	<1W
Switched power	800W(capacitive) 2000W(resistive)

Sensor Data

Model No.	
Sensor principle	High Frequency (microwave)
Operation frequency	5.8GHz +/- 75MHz
Transmission power	<0.2mW
Detection range	Max. (Ø x H) 12m x 3m
Detection angle	30° ~ 150°

Environment

Operation temperature	Ta: -20°C ~ +60°C
Case temperature (Max.)	Tc: +80°C
IP rating	IP20
Warming-up	20s

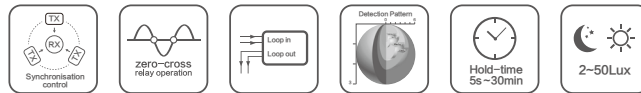

Functions and Features (HC009S/EXT)

1 On/off Control

This sensor is a motion switch, which turns on the light upon detection of motion, and turns off after a pre-selected hold-time when there is no movement. A daylight sensor is also built in to prevent the light from switching on when there is sufficient natural light.

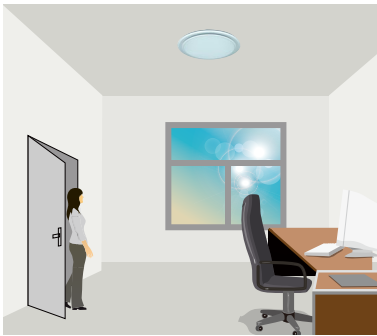

With sufficient natural light, the light does not switch on when presence is detected.

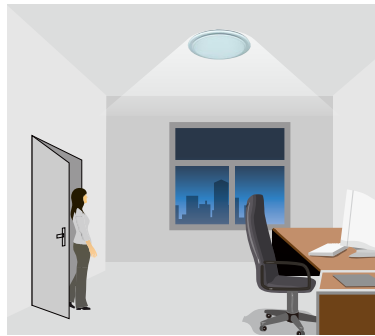

With insufficient natural light, the sensor switches on the light automatically when presence is detected.



The sensor switches off the light automatically after the hold-time when there is no motion detected.

2 Synchronisation Control

In many cases, several sensors are connected together to control the same fixture, or to trigger each other, the sudden on/off of the lamp tube or the ballast/driver causes huge magnetic pulse, which may mis-trigger the sensor. This sensor has a very advanced software to ignore that interference.

By connecting L' terminal with L' on another sensor, if any of the master fixture (containing sensor) is triggered, all luminaries (including slaves and other master unit in the group) will also light up.

3 Zero-cross Relay Operation

Designed in the software, sensor switches on/off the load right at the zero-cross point, to ensure that the in-rush current is minimised, enabling the maximum lifetime of the relay.

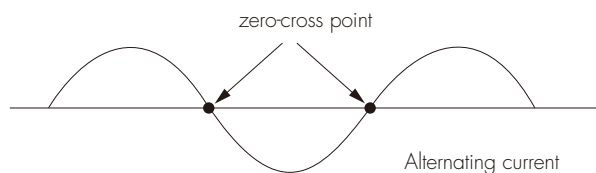

4 Loop-in and Loop-out Terminal

Double L N terminal makes it easy for wire loop-in and loop-out, and saves the cost of terminal block and assembly time.

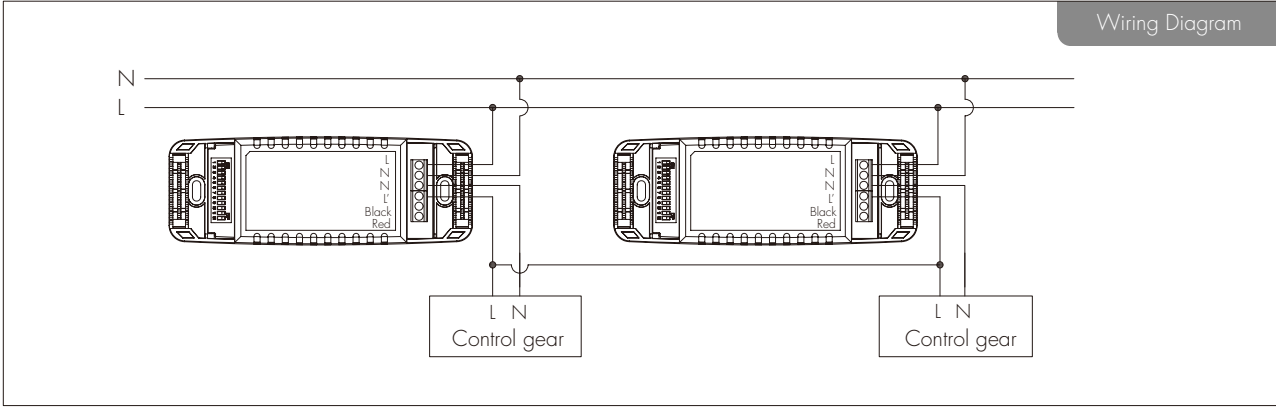

DIP Switch Settings (HC009S/EXT)

1 Detection Range

Sensor sensitivity can be adjusted by selecting the combination on the DIP switches to fit precisely for each specific application.

	1	2	3	
I	●	●	●	100%
II	○	●	●	75%
III	●	○	●	50%
IV	●	●	○	25%
V	○	○	○	10%

- I – 100%
- II – 75%
- III – 50%
- IV – 25%
- V – 10%

2 Hold Time

Select the DIP switch configuration for the light on-time after presence detection. This function is disabled when natural light is sufficient.

	4	5	6	7	
I	●	●	●	●	5s
II	○	●	●	●	30s
III	●	○	●	●	1min
IV	●	●	○	●	5min
V	●	●	●	○	15min
VI	○	○	○	○	30min

- I – 5s
- II – 30s
- III – 1min
- IV – 5min
- V – 15min
- VI – 30min

3 Daylight Threshold

Set the level according to the fixture and environment. The light will not turn on if ambient lux level exceeds the daylight threshold preset.

Please note that the ambient lux level refers to internal light reaching the sensor.

Disabling the daylight sensor will put the sensor into occupancy detection only mode.

	8	9	10	11	12	
I	●	●	●	●	●	2Lux
II	○	●	●	●	●	5Lux
III	●	○	●	●	●	10Lux
IV	●	●	○	●	●	30Lux
V	●	●	●	○	●	50Lux
VI	○	○	○	○	○	Disable

- I – 2Lux
- II – 5 Lux
- III – 10 Lux
- IV – 30 Lux
- V – 50 Lux
- VI – Disabled

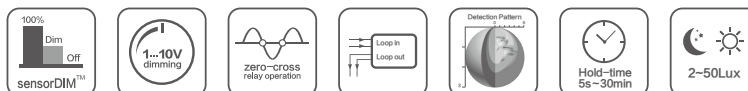
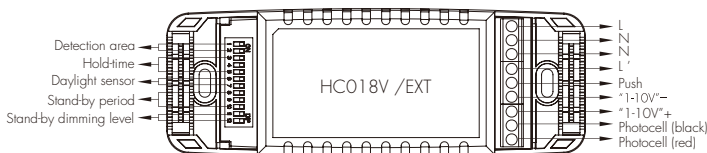

1 Tri-level Control (Corridor Function)

Hytronik builds this function inside the motion sensor to achieve tri-level control, for some areas which require a light change notice before switch-off. The sensor offers 3 levels of light: 100%→dimmed light→off; and 2 periods of selectable waiting time: motion hold-time and stand-by period; Selectable daylight threshold and freedom of detection area.

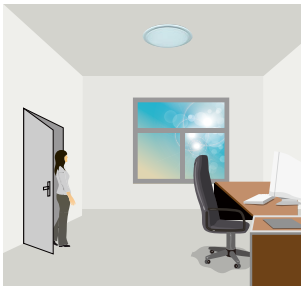

With sufficient natural light, the light does not switch on when presence is detected.

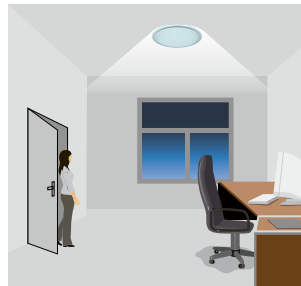

With insufficient natural light, the sensor switches on the light automatically when presence is detected.

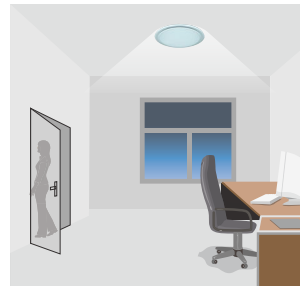

After hold-time, the light dims to stand-by level or switch off if the stand-by period is pre-set to 0s.

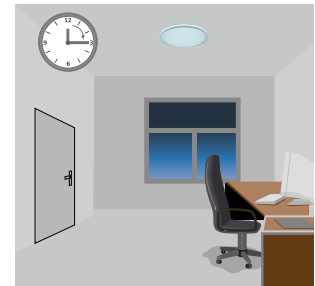

Light switches off automatically after the stand-by period elapses.

2 Zero-cross Relay Operation

Designed in the software, sensor switches on/off the load right at the zero-cross point, to ensure that the in-rush current is minimised, enabling the maximum lifetime of the relay.

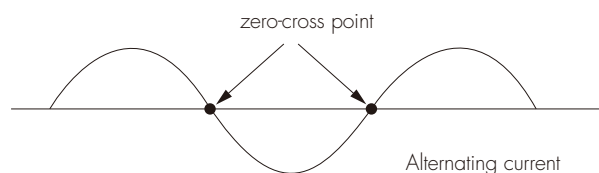

3 Loop-in and Loop-out Terminal

Double L N terminal makes it easy for wire loop-in and loop-out, and saves the cost of terminal block and assembly time.

4 Manual Override

This sensor reserves the access of manual override function for end-user to switch on/off, or adjust the brightness by push-switch, which makes the product more user-friendly and offers more options to fit some extra-ordinary demands:

* Short Push (< 1s): on/off function;

On → Off: the light turns off immediately and cannot be triggered ON by motion until the expiration of pre-set hold-time. After this period, the sensor goes back to normal sensor mode.

Off → On: the light turns on and goes to sensor mode, no matter if ambient Lux level exceeds the daylight threshold or not.

* Long Push (> 1s): adjust the hold-time brightness level between 10% and 100%.

Note: if end-user do not want this manual override function, just leave the "push" terminal unconnected to any wire.

5 Semi-auto Mode (Absence Detection)

It is easy to forget to switch off the light, in office, corridor, even at home. And in many other cases, people do not want to have a sensor to switch on the light automatically, for example, when people just quickly pass-by, there is no need to have the light on. The solution is to apply this "absence detector": motion sensor is employed, but only activated on the maunal press of the push switch, the light keeps being ON in the presence, and dims down in the absence, and eventually switches off in the long absence.

This is a good combination of sensor automation and maunal override control, to have the maximum energy saving, and at the same time, to keep efficient and comfortable lighting.

Note: end-user can choose either function 4 or function 5 for application. Default function is manual override.

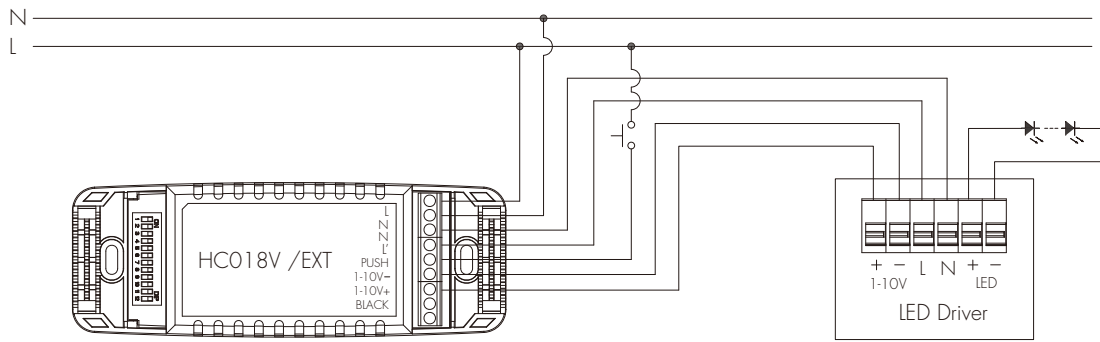

DIP Switch Settings (HC018V/EXT)

1 Detection Range

Sensor sensitivity can be adjusted by selecting the combination on the DIP switches to fit precisely for each specific application.

	1	2	
I	●	●	100%
II	●	○	75%
III	○	●	50%
IV	○	○	10%

- I – 100%
- II – 75%
- III – 50%
- IV – 10%

2 Hold Time

Select the dip switch configuration for the full brightness on-time after presense detection. This function is disabled when natural light is sufficient.

	3	4	5	
I	●	●	●	5s
II	●	●	○	30s
III	●	○	○	1min
IV	●	○	○	5min
V	○	●	●	10min
VI	○	●	○	20min
VII	○	○	○	30min

- I – 5s
- II – 30s
- III – 1min
- IV – 5min
- V – 10min
- VI – 20min
- VII – 30min

3 Daylight Threshold

Set the level according to the fixture and environment. The light will not turn on if ambient lux level exceeds the daylight threshold preset.

Please note that the ambient lux level refers to internal light reaching the sensor.

Disabling the daylight sensor will put the sensor into occupancy detection only mode.

	6	7	
I	●	●	Disable
II	●	○	50Lux
III	○	●	10Lux
IV	○	○	2Lux

- I – Disable
- II – 50Lux
- III – 10Lux
- IV – 2Lux

4 Stand-by period (corridor function)

This is the time period you would like to keep at the low light output level before it is completely switched off in the long absence of people.

Note: "0s" means on/off control;

"+ ∞" means the stand-by time is infinite and the fixture never switches off.

	8	9	10	
I	●	●	●	0s
II	●	●	○	10s
III	●	○	●	1min
IV	●	○	○	5min
V	○	●	○	10min
VI	○	●	○	30min
VII	○	○	●	1H
VIII	○	○	○	+∞

- I – 0s
- II – 10s
- III – 1min
- IV – 5min
- V – 10min
- VI – 30min
- VII – 1H
- VIII – +∞

5 Stand-by dimming level

The setting is used to select the desired dimmed light level used in periods of absence for enhanced comfort and safety.

	11	12	
I	●	●	10%
II	●	○	20%
III	○	●	30%
IV	○	○	50%

- I – 10%
- II – 20%
- III – 30%
- IV – 50%

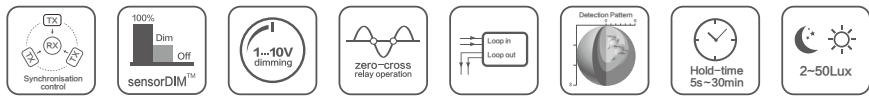
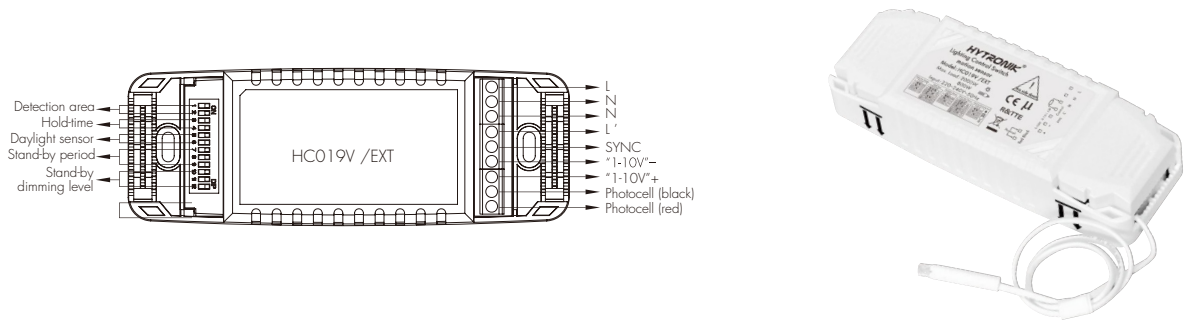

Functions and Features (HC019V/EXT)

1 Tri-level Control (Corridor Function)

Hytronik builds this function inside the motion sensor to achieve tri-level control, for some areas which require a light change notice before switch-off. The sensor offers 3 levels of light: 100% -> dimmed light -> off; and 2 periods of selectable waiting time: motion hold-time and stand-by period; Selectable daylight threshold and freedom of detection area.

2 Synchronisation Function

By connecting all the "1-10V-" and "SYNC" terminals in parallel (see wiring diagram next page), no matter which master sensor detects motion, all slave luminaires in the group will turn on at the same time.

With sufficient natural light, the lights does not switch on when presence detected.

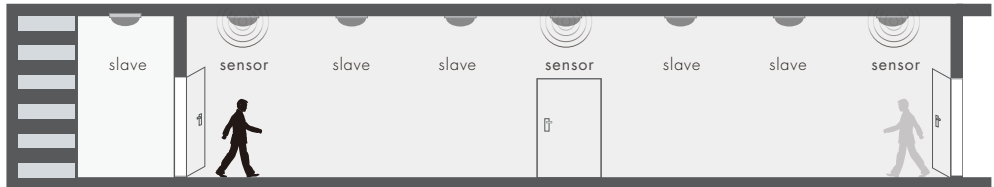

With insufficient natural light, the person comes from any direction, the whole group of lights switch on.

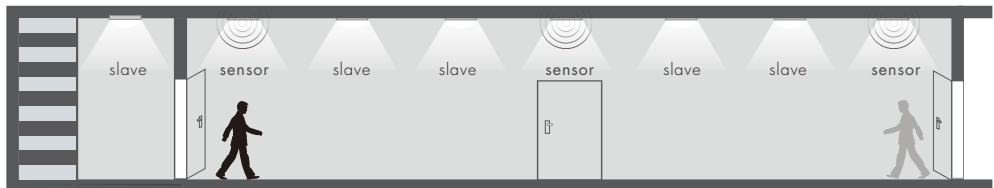

The lights dim to stand-by level after hold-time, or turn off completely if surrounding natural light is sufficient.



The lights switch off automatically after the stand-by period.

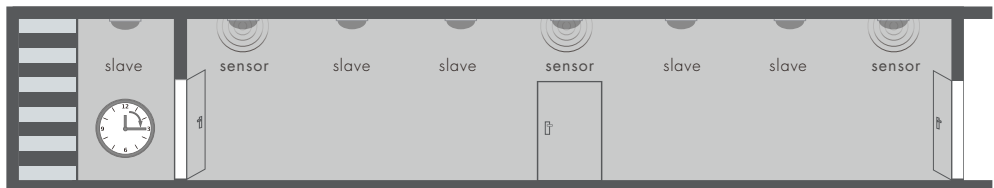

3 Zero-cross Relay Operation

Designed in the software, sensor switches on/off the load right at the zero-cross point, to ensure that the in-rush current is minimised, enabling the maximum lifetime of the relay.

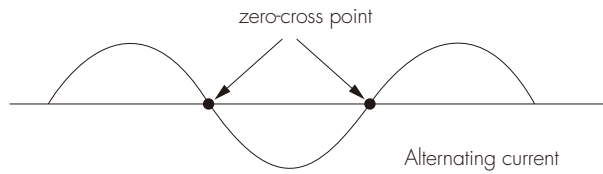

4 Loop-in and Loop-out Terminal

Double LN terminal makes it easy for wire loop-in and loop-out, and saves the cost of terminal block and assembly time.

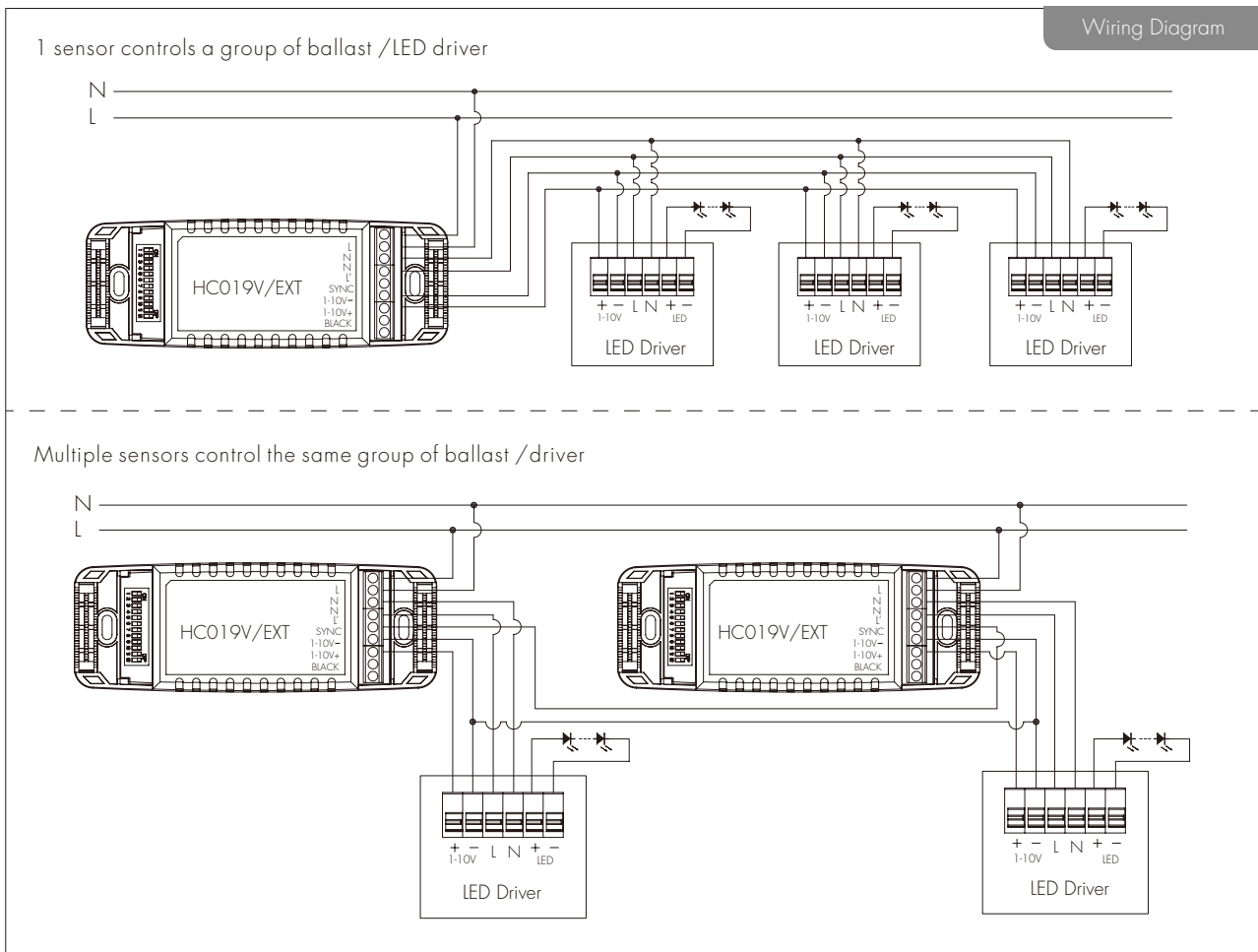

DIP Switch Settings (HC019V/EXT)

Same as HC018V/EXT.