

GSTN

GEAR SHIFT DEVICE

Tension/Compression sensor with analog and ON/OFF outputs. Resettable offset and adjustable thresholds.

Ref: SN :

Software version:

Texys sensors are designed for data recording. If the user wants to include this sensor in a close loop system or active control, he must assume all responsibility.

Range	±1000	N	
Overload	±1500	N	
Accuracy	5%	%	
Supply Voltage	5 to 16	V	
Supply Current	8	mA	
Analog Signal White wire	0 to 5*	V	
Offset (no force)	2.5 ±25mV	V	
Sensitivity	2.3 ±0.5	mV/N	
Cut off frequency	30	Hz	
On/Off output Green wire	NPN Open collector, normally open, max 16V, 20mA Switched to 0V when detection Must be protected by diode if an inductive load, such a relay, is connected.		
Debounce time	30	msec	
Offset Drift with temperature	<10	mV	
Dim	M6 ends	57 x 12	mm
	M8 ends	67 x 12	mm
Material	Stainless Steel		
Weight	25 (+cable)	g	
Protection	IP63		
Vibration test	20 Gpp5'		
Shock	500	G	
Operating Temp	0 to +85	°C	
Storage Temp	-20 to +125	°C	

*limited by supply voltage

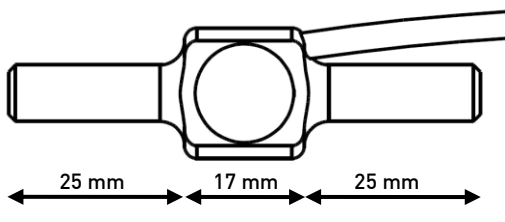
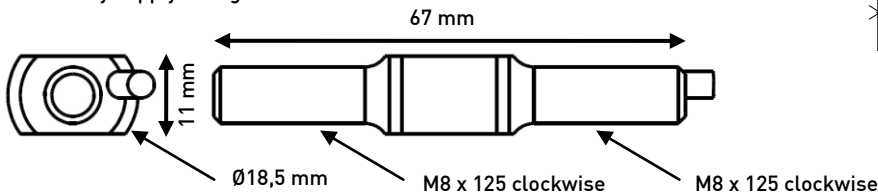

GSTN8

Sensor Readings	
Offset (Volts)	Signal @ 300 N

Sensor Settings	
Force (T / C)	
Threshold (bips or N)	
Cut Off Time (bips)	

Calibration table	
Force (Newtons)	Signal (analog output)
-300	1 [⁄] 8
0	2 [⁄] 5
+300	3 [⁄] 2

Cable : 4x26AWG FEP Tinned copper braided cable 250V 200°C

Length : _____ mm Tubing: _____

Connector : _____

Colour	Function	Pin
Red	Supply	
Black	0V	
White	Analog Signal 0-5V	
Green	On/Off Signal NPN open collector Must be isolated if not used	
Braid	Connected to case	

Ordering ref ex: GSTN6

GSTN 6 (M6)
8 (M8)

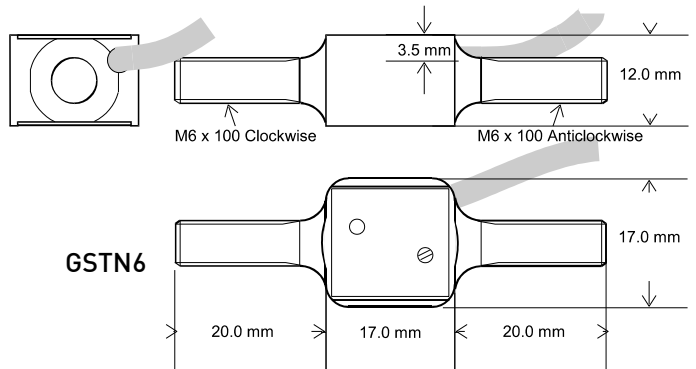

GSTN6

Wiring

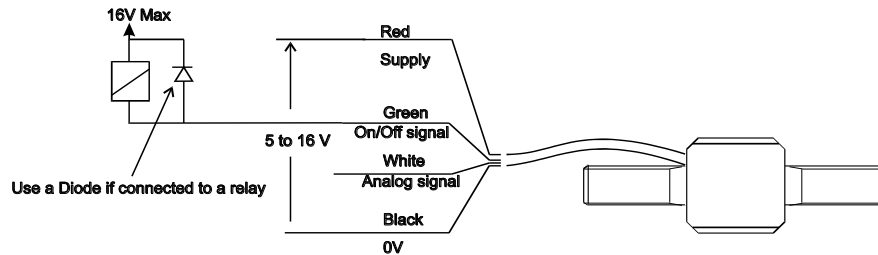

Setting modes

Connect a LED with 1K resistor between supply (red) and On/Off output (green)

Offset setting:

No force must be applied to the device.
Place a 4K7 Resistor between analog output (white) and 0V (black)
Switch on the power.
The LED blinks once
When the offset is set to 2V5, the LED remains lit.
Switch off the power and remove the 4K7 resistor.

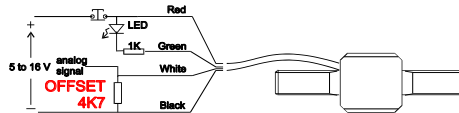

Setting Offset to 2V5

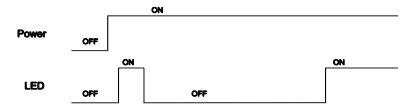

Threshold setting on Compression or Tension (ON/OFF output switching):

Apply the desired compression force to the device.
Place a 10K Resistor between analog output (white) and 0V (black)
Switch on the power.
The LED blinks twice
When the threshold is recorded, the LED remains lit.
Switch off the power and remove the 10K resistor.
If the force is less than about 50N, the compression threshold will be kept at this default value.

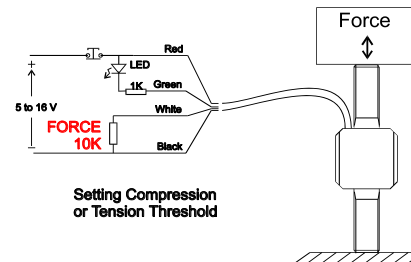

Setting Compression or Tension Threshold

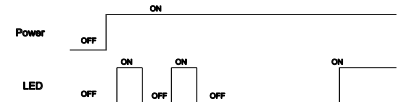

Compression and tension settings are independent, operate them separately

Check mode:

No force must be applied to the device.
Place a 1K Resistor between analog output (white) and 0V (black)
Switch on the power.
The LED blinks 3 times
Then the output will give the raw value of the load cell.
If the raw value is < 0.5V or > 4.5 V, the load cell has become too unbalanced and the device will not work properly,
Switch off the power and remove the 1K resistor.

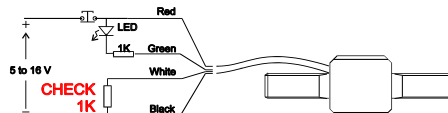

Check Mode

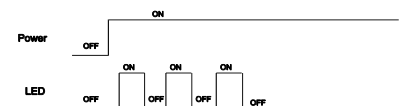

A switch board is available at Texense to help the setting operations

