

BINBOK VR T3 Plus

For Meta/Quest 3

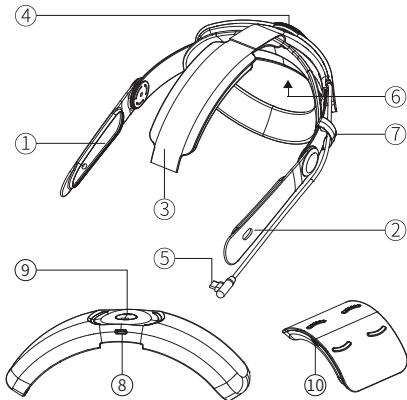

VR39-1



1. Right Side Strap

3. Top Strap

5. Battery Cable

7. Cable Clip

9. Power Button

2. Left Side Strap

4. Rear Fit Wheel

6. Rear Brace

8. Charging Port

10. Charging Port

Step 1 Attach the Rear Brace to the Strap

Clip the rear brace into the strap according to the corresponding R and L letters-you will hear a clear "click" as it attaches.

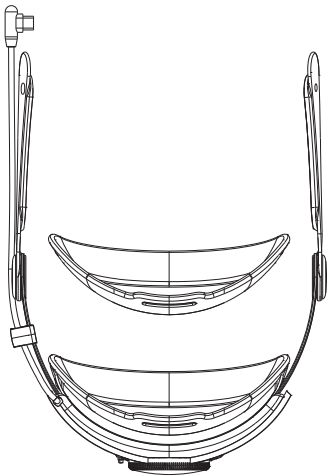

Step 2 Install the Top Strap

Thread the top strap through the bracket of the rear brace. Smooth side down.

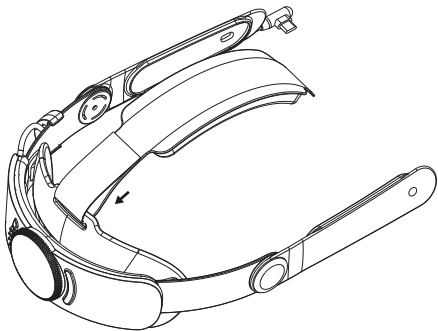

Step 3 Pull Out the Facial Interface

Remove the facial interface from the Quest 3 headset.

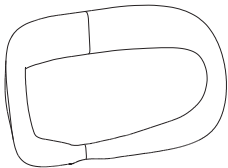
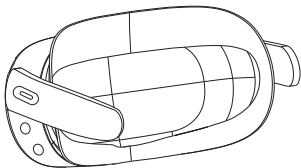

Step 4 Thread and Fasten the Top Strap

Thread the top strap through the bracket in the front of the Quest 3 to fasten it.

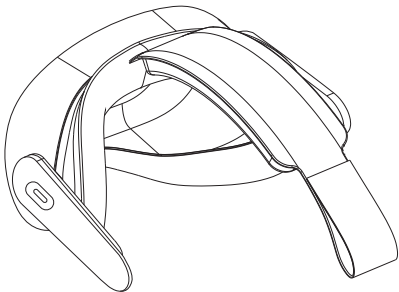

Step 5 Attach Side Straps

Hook the strap sides to the arms of the headset snap on by applying pressure down.

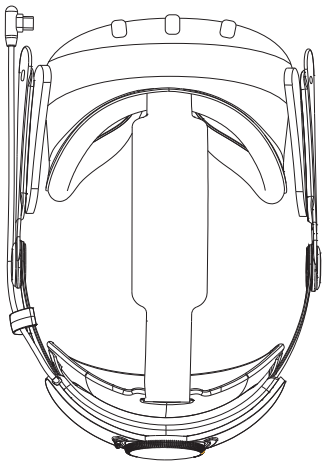

Step 6

Re-insert the facial interface and snap it into place.

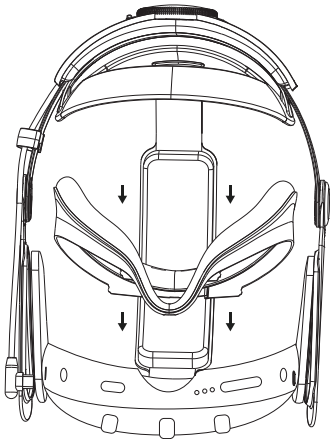

Step 7 Attach the magnetic battery to the head strap

Align the magnetic battery contacts with the pins on the head strap to attach the battery to the head strap and begin charging.

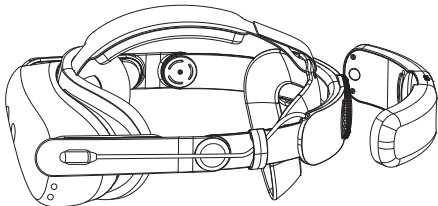



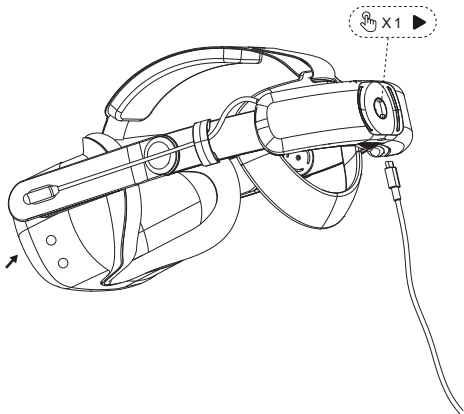

Simultaneous Charging

To charge the Quest 3 headset and head strap battery at the same time, make sure to connect the battery cable from the strap to the headset's USB-C port, and press the power button once after plugging it into the charger.

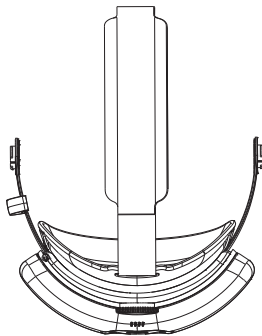

Power button is designed for activating the smart charging on the Quest 3. To charge the strap individually, leave the power button in the " Off" position after plugging it into charge.



-  x1  Press once to start charging
-  x2  Press twice to stop charging

Power the charger station

Connect the cable to the Type-C port to start supplying power to the charger station.

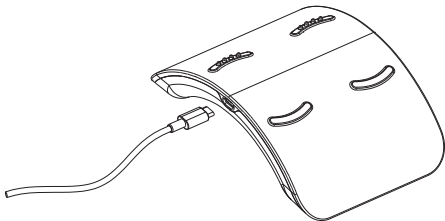

Attach the magnetic battery to the charger station

Align the magnetic battery contacts with the pins on the charger station to attach the battery to the station and begin charging.

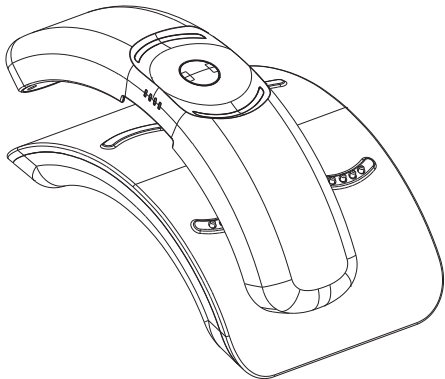





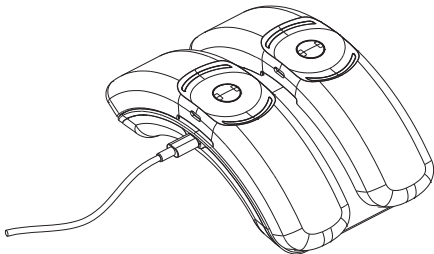

Charging: LED flashes at current power level

Fully Charged: LED1-4 lights up



Product Electrical Specifications

Product Model	VR39-1		
Material	Rear Brace(TPU), Cushioned Top Strap(PU), Shell(PC+ABS Fire-proof Material)		
Battery Type	Lithium Ion Polymer		
Nominal Capacity	8000mAh/29.6Wh		
Output Parameter	Type-C Cable	5.0V3A±0.3A(max)	
	Type-C Port	5.0V3A±0.3A(max)	
Input Parameter	Type-C Port	Type-C :5.0V3A±0.3A(max)	
	Charger Station	Type-C :5.0V3A±0.3A(max)	
Operating Temperature	0~45°C		
Storage Temperature	-10~45°C		
Humidity Range	<75% RH		
Indicator Light (Charge)	Battery	Charging	LED Flashes at Current Power Level
		Fully Charged	LED1-4 Lights up
	Charger Station	Charging	Breathing Light
		No-load /Fully Charged	Light off
Indicator Light (Discharged)	LED	On at Current Battery Level	
	Atmosphere Lamp	Breathing Light	
Battery Status Display			
	Run Out of Battery Over temperature Over current Over voltage	LED1-4 Flashes	
	≤1%	LED1 Flashes	
	1%~25%	LED1 Lights up	
	25%~50%	LED1-2 Lights up	
	50%~75%	LED1-3 Lights up	
	75%~100%	LED1-4 Lights up	
<p>Tips: ● means on, ◎ means flashing, ○ means off. The LED displays the current battery level during discharge.</p>			

Health & Safety Warnings

▲ WARNING

To reduce the risk of personal injury,discomfort or property damage,please ensure that all usersof these accessories carefully read the warnings below.

1. It is important that you carefully read the Health and Safety Guide enclosed with your VR headset in addition to these warning before using your VR system.
2. Read and follow all setup and operating instructions provided with the headset. Follow instructions for installing the Excellence Strap With Battery on your headset.
3. These accessories are not toys and should not be used by children under the age of 13.
4. To avoid transferring contagious conditions(like pink eye), do not share the headset or either of these accessories with persons with contagious conditions, infections or diseases, particularly of the eyes, skin, or scalp. The headset and accessories should be cleaned between each use with skin-friendly non-alcohol, non-abrasive antibacterial wipes.Replace the battery-powered Excellence Strap if it becomes worn or cannot be cleaned.
5. The headset and the Excellence Strap With Battery are worn next to your skin and scalp. Stop using the headset if you notice swelling, itchiness, skin irritation,loss of hair or other skin reactions. If symptoms persist,contact a doctor.

Safety Guidelines

▲ WARNING

1. DO NOT allow the product to come into contact with any kind of liquid. DO NOT leave the product out in the rain or near a source of moisture. DO NOT drop the product into water. If the inside of the battery comes into contact with water, chemical decomposition may occur, potentially resulting in the battery catching on fire, and may even lead to an explosion.
2. Put out any product fire using water, sand, fire blanket, or a dry powder fire extinguisher.
3. The product should be used in temperatures from 0°C to 40°C(32°Fto 104°F). Use of the product in environments above 40°C(104°F)can lead to a fire or explosion. Use of the product below 0 °C(32°F can lead to permanent damage.
4. Never disassemble or pierce the product in any way or the battery may leak,catch fire,or explode.
5. DO NOT drop or strike the product DO NOT place heavy objects on the product.
6. DO NOT heat the product. DO NOT put the product in a microwave oven or in a pressurized container.
7. DONOT leave the product near heat sources such as a furnace or heater. DO NOT leave the product inside of a vehicle on hot days. The ideal storage temperature is 22°C to 28°C(72°Fto82°F).

8. DO NOT store the product fully discharged for an extended period. Otherwise, it will over discharge, which will lead to permanent damage.
9. DO NOT attempt to charge or use the headset or Excellence Strap With Battery if it does not turn on after attempted charging, if it gets abnormally warm when it is used or charged, or if the battery compartment is swollen, leaking liquid, or smoking.
10. Always ensure that the headset and Excellence Strap With Battery have adequate ventilation and air flow while in use or charging. Covering the headset or Excellence Strap with Battery with materials that significantly affect air flow may affect performance and poses a possible risk of fire or explosion.

Headset Temperature

It is important to check the temperature of your headset and Excellence Strap With Battery as some contact points-including front surfaces-may get hot. It is normal for your headset or Excellence Strap With Battery to feel warm to the touch while in use or while charging. Prolonged skin contact with a headset or Excellence Strap With Battery that is hot where it touches the skin may produce skin discomfort or redness, or low-temperature burns. If your headset or the Excellence Strap With Battery feels hot to the touch or is uncomfortably warm, stop using or charging it and allow it to cool down.

To reduce risk of electric shock:

- Do not modify or open any of the components provided.
- Do not charge this device if any part of the AC Adapter cable is torn, any wires are exposed, or battery compartment damaged.
- Do not insert any metal, conductive, or any foreign objects into the charging port.
- Do not expose the device to water or fluid.