

Yaber

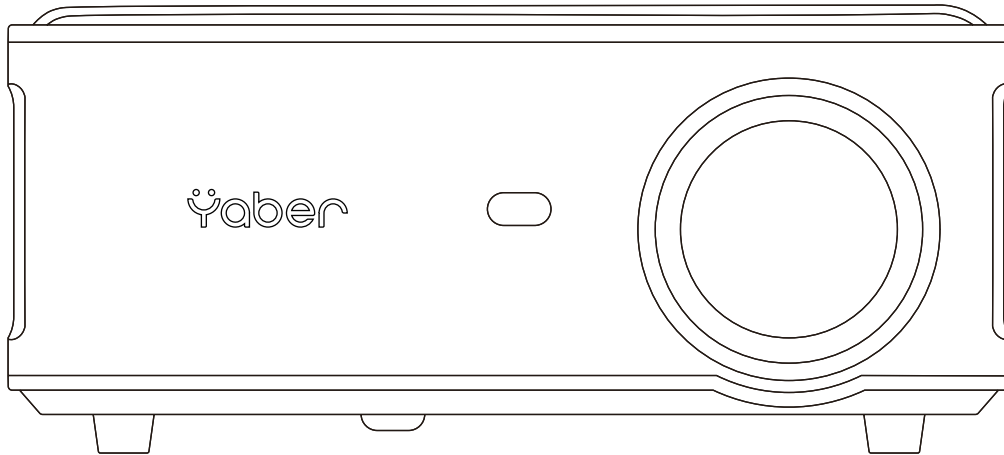

Pro U6 PROJECTOR **EN**

CONTENS

YABER Lifetime Professional Support	2
Tips	2
Package List	3
Projector Specifications	4
Projector Overview	4
Remote Contol	7
Installation	8
1. Installation Method	8
2. Install on the Ceiling	9
Starting Projector	10
Image Adjustment	10
1. Focus Adjustment	10
2. Digital 4D Keystone Correction	11
Setting Up The Projector	11
1. Select The Insert Signal Source	11
2. USB Disk Input Mode	11
2.1 Play Video/Audio/Image/Office in the USB Disk Input Mode	11
2.2 Play Interface	12
2.3 Music Play Interface	13
2.4 Picture Play Interface	14
3. WiFi Setting	15
3.1 iOS Cast (for iOS Devices)	15
3.2 MaxhubShare (for Android Devices)	16
4. Bluetooth Setting	17
5. Projector Image Setting	18
5.1 Projection Mode	18
5.2 Keystone Advanced & 4-Point Keystone	19
5.2.1 Vertical Keystone Correction	19
5.2.2 Horizontal & Vertical Keystone Correction	19
5.3 Digital Zoom	21

6. System Update - - - - -	21
7. Common - - - - -	22
Signal Lines Connection - - - - -	23
1. Connect the Devices via the HDMI ports- - - - -	23
2. Connect to the DVD Player- - - - -	23
3. Connect to the Sound bar/Speaker - - - - -	24
Safe Shutdown - - - - -	24
Warranty - - - - -	24

YABER Lifetime Professional Support

Dear customer,

Thank you very much for supporting YABER!

Please read this manual thoroughly before using the projector. If you have any issues, email your order number and the problem to **aftersales@yabertch.com** We will provide a fast solution in 24 hours.

Actually, many problems can be easily solved by setting, such as no signal, no sound, bluetooth connection failed, WiFi connection failed, dark spots, choppy animation etc. We promise all the projectors have been 100% carefully checked and packaged before shipping.

If you have any questions, could you please contact us so that the problem can be solved. And give us an opportunity to improve. We guarantee we will provide you a satisfactory solution.

Thanks for your understanding!

YABER Service Team

Tips

1. Do not place projector in too warm or too cold room, because the high temperature or low temperature will shorten lifespan of the device. The working environment would be 5°C ~35°C better.
2. If there are black spots on the projection screen, please don't worry, please contact **aftersales@yabertch.com** via email, we can send you a video about how to remove the dust.
3. The projector shall be strictly protected from strong impact, extrusion and vibration. Do not try to move and on strong impact, extrusion and vibration. Do not try to move and the internal circuit faults.
4. Lens, as the core component of the projector, is directly related to the picture definition and effect. The excessive dust thereon will affect image quality. The dirty lens shall be wiped with soft cotton cloth for the glass lens surface. Hard cloth or abrasives shall not be used.

Package List

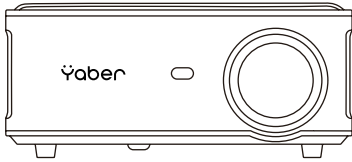

Pro U6 Projector

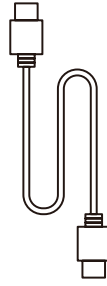

HDMI Cable

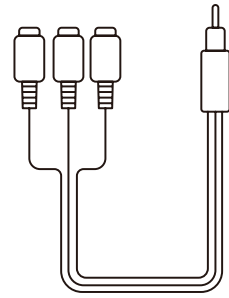

3-in-1 AV Cable

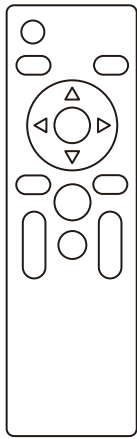

Remote Control

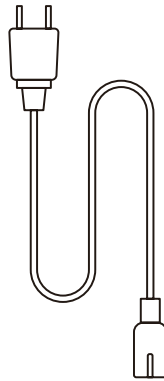

Power Cord

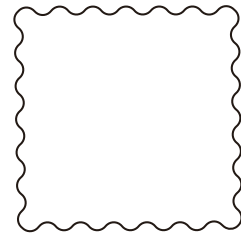

Cleaning Cloth

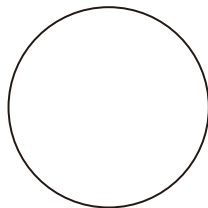

Lens Cover



Quick Start Guide

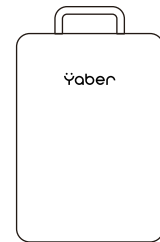

Carry Bag

Projector Specifications

Model No. Pro U6			
Native Resolution	1920*1080P	Keystone Correction	Manual Vertical& Horizontal
Display Technology	LCD	Light Source	LED
Color Game	16.7M Full	Aspect Ratio	4:3/16:9
Recommended Projection Distance	4.5-16.0ft	Minimum Projection Distance	4.5ft
Power Voltage	AC100-240V	Projector Weight	4.9lbs
Picture File	JPG/JPEG/ BMP/PNG	Interfaces	HDMI*2/USB*2/3.5mm Headphone jack/AV/ RJ45
Projection Method	Front/Rear on Desk, Front/ Rear on Ceiling		
Video File	MP4/MKV/WMV/3GP/MPG/VOB/TP/TS/DAT/MOV/FLV		
Audio File	MP3/AAC/WAV/WMA/M4A/AAC/OGG/FLAC		

Projector Overview

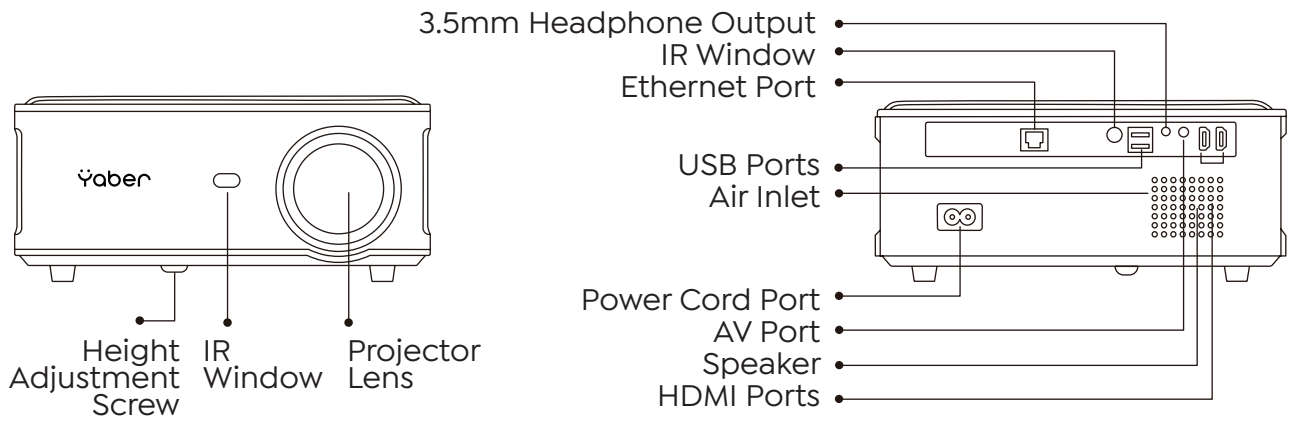

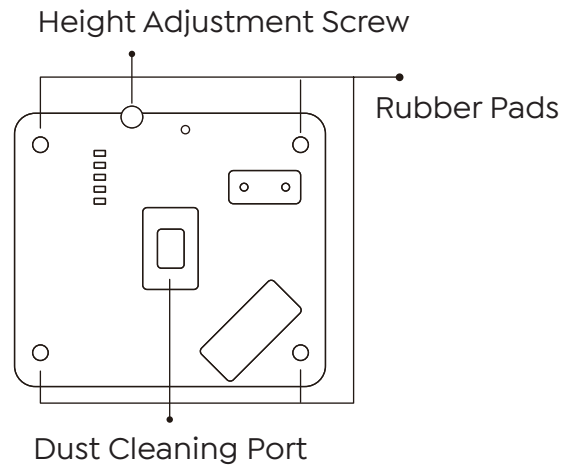
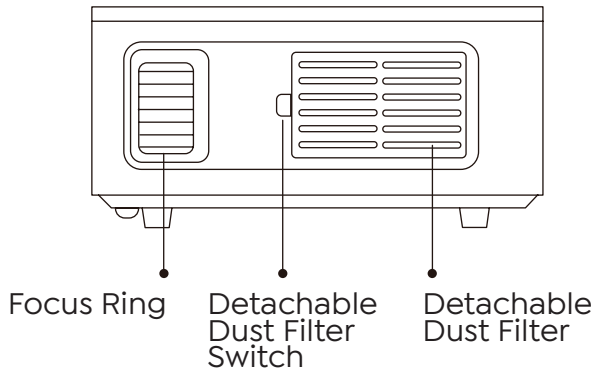

Height Adjustment Screw	Adjust the height of the projector
IR Window	Infrared signal receiver
Projector lens	Optical coated glass lens
Power Cord Port	Power Cord Port
Headphone Jack	3.5mm Headphone Output
HDMI Ports	HDMI 1 input / HDMI 2 input
USB Ports	USB 1 port / USB 2 port
AV Port	Audio input
Speaker	Stereo 5W
Air Outlet	Prevent the projector from overheating
Focus Ring	Adjust the focus ring to get the clearest image
Detachable Dust Filter Switch	Push the switch to open the detachable dust filter
Detachable Dust Filter	Prevent the projector's inside from the dust
Dust Cleaning Port	When black spots and dust appear on the screen, open the port to clean the dust
Rubber Pads	Protective pads/remove to install ceiling mount
Ethernet Port	Connect to the Ethernet

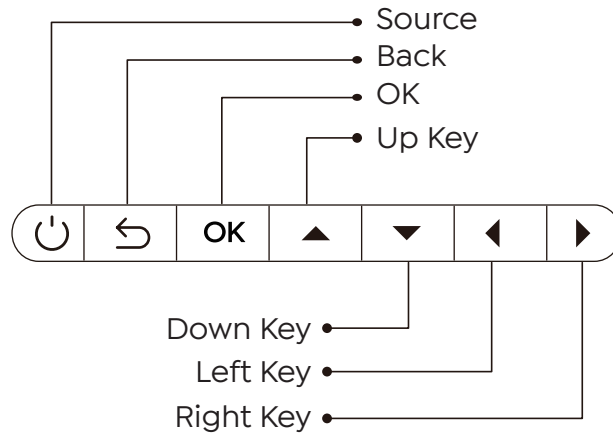

Power	Turn on/off the power
Back	Return to the previous menu
Ok	Confirm the option
Up Key	Used to adjust the parameter of the projector in the menu mode
Down Key	
Left Key	
Right Key	

Remote Control

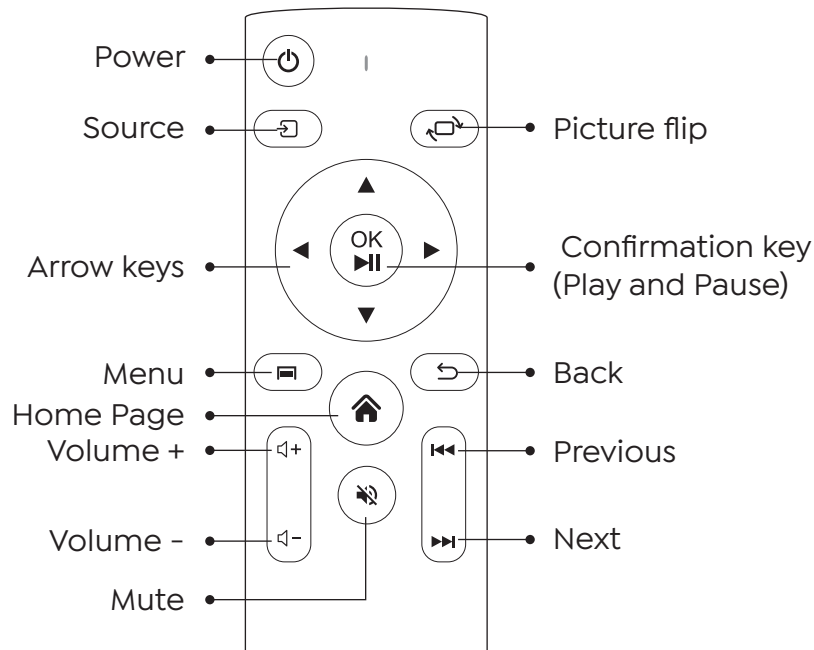

Power	Turn on/off the power
Source	Select the input signal source
Arrow keys	Used to adjust the parameter of the projector in the menu mode
Menu	Press once: Operate picture and sound settings in AV or HDMI Mode Press twice in succession: select 16:9/4:3 projection
Home Page	Enter the home page
Volume +	Volume up
Volume -	Volume down
Mute	Close the sound
Picture flip	Picture flips
Confirmation key	Confirm the option/Play or pause the video
Return	Return to the previous menu
Previous	Switch to the previous video
Next	Switch to the next video

Note:

1. Install 2 pieces of AAA batteries into the remote controller before using it. Do not combine new batteries with old ones in remote controller, which can cause operation failure due to insufficient power supply.
2. When using the remote controller, please make sure that the signal transmitter of the remote controller aims at infrared signal receiver of the projector.
3. If you are not using the remote controller for an extended period, please take out batteries to prevent batteries leakage.

Installation

1. Installation Method

The projector can be hanged on the ceiling with special hanger frame, and placed on the stable desk to project the image according to the operating environment and requirements. In addition, the projector can be installed with following methods:

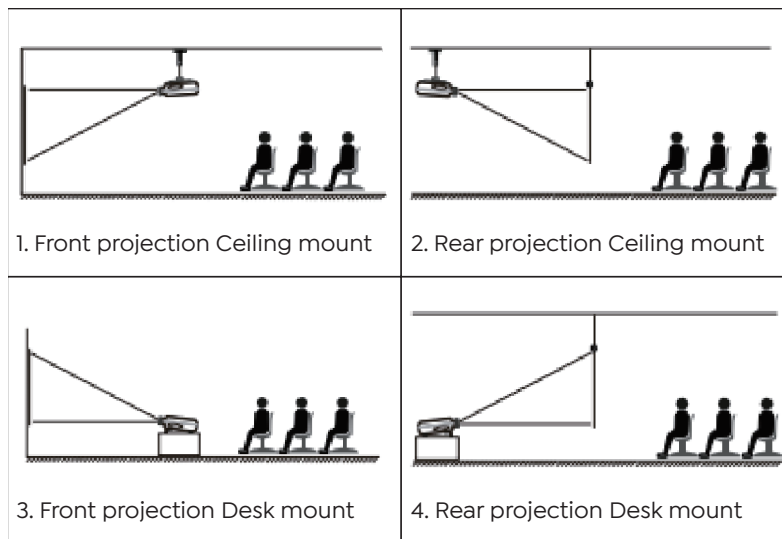

Keep the projector at a height where its lens is axial symmetry to the screen. If this is not possible, use the keystone correction function to adjust the projection image. If you want to get a free projection screen, please contact us via aftersales@yabertch.com.

Aspect Ratio: 16:9	
Distance (ft.)	Screen Size
4.5	40"
6.7	60"
8.9	80"
11.2	100"
13.4	120"
16.8	150"

The recommended projection distance is about 11.2ft, the shortest projection distance is 4.5ft. The image size depends on the distance between projector and screen, there may be 3% deviation among above listed data. Different settings cause various distances.

2. Install on the Ceiling

The projector can be hanged on the ceiling with special hanger frame, and placed on the stable desk to project the image according to the operating environment and requirements. In addition, the projector can be installed with following methods:

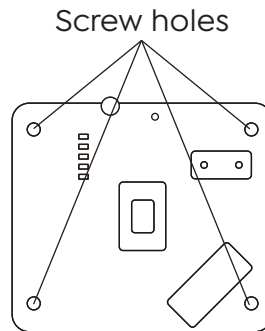
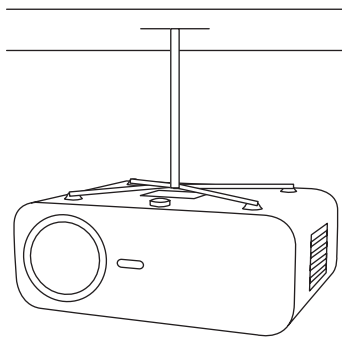

1. Please purchase an universal projector ceiling mount;
2. Remove the four rubber pads on the bottom of the projector, you will see the screw holes and use the M5*11mm screws for installing the ceiling, and then install it.

Starting Projector

1. Press the power key on the remote controller or projector, the indicator light will turn blue.
2. Use the focus function of the projector to get the best image performance.(If it is still blurry, please try to adjust the projection distance.)
3. Use the keystone function of the projector to get a rectangle projection screen.
4. Connect the external device (Smart phone, iPad, Fire TV, TV box, DVD player, Computer, etc.) in the corresponding interfaces of the projector, please be sure to select the corresponding source. If you do not select the correct source, the projector will not be able to detect the signal.
5. Select the "⚙️" menu,enter the [Common], then you can select the option [Language] to set your preferred language.

Image Adjustment

When using the projector for the first time, it normally displays an unclear image. This is due to the lens being out of focus or the incorrect trapezoid setting.

Please follow the below steps to correct:

1. Focus Adjustment

Focus Ring

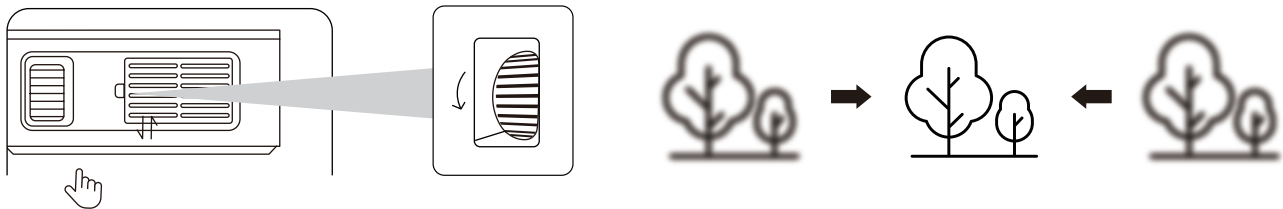

Rotate the focus ring or lens slowly. At the same time, check the focus point carefully. The best focus point for the lens would be where the image most clear.

Note: If it is still blurry, please try to adjust the projection distance.

2. Digital 4D Keystone Correction

Use the digital 4D keystone correction of the projector to change the image to be rectangle(vertical and horizontal). Detail please refer the page 16 of this manual.

Setting Up The Projector

The projector's home page is as follow.

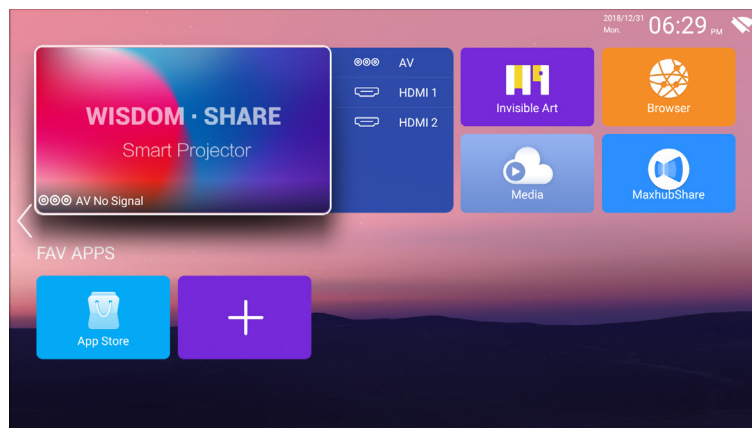

1. Select The Insert Signal Source

Select the desired insert signal source (HDMI1/HDMI2/AV) on the home-page.

2. USB Disk Input Mode

2.1 Play Video/Audio/Image/Office in the USB Disk Input Mode

1. Insert the USB Disk, Select the icon [Media]
2. Select the option [All/Video/Audio/Image]
3. Select the desired file (or folder to enter the subfolder) in the USB disk, then press the [OK] button to play it.

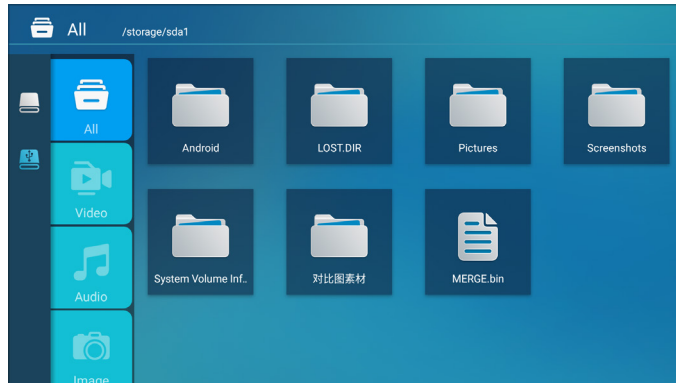

PS: 1.Pro U6 upgraded projector supports U disk to directly play PPT, Word, Excel files.

2.If you enter from the [Video] menu, you can only play the video, The same as other 3 options.

2.2 Play Interface

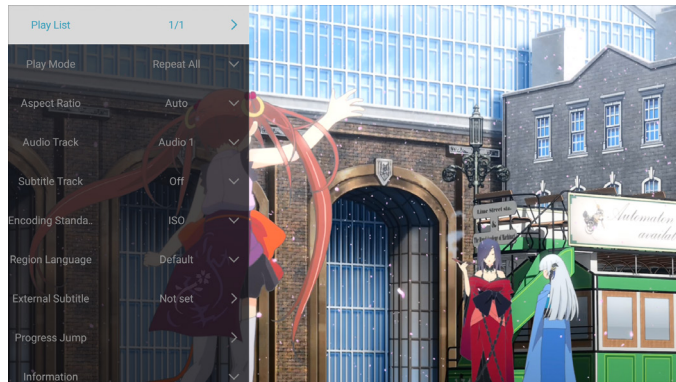

Playing setting	Include	Function
Play List	the videos of current folder	change video from the current folder
Play mode	repeat all, auto exit, repeat one, random, play list	change play mode
Aspect Ratio	auto, 16:9, 4:3, zoom1, zoom2	set video aspect ratio
Audio Track	audio track	set audio track
Subtitle Track	subtitle track	set subtitle track
Encoding Standard	iso, windows	set encoding standard
Region Language	various language	set region language
External Subtitle	external subtitle	choose subtitle from other folders
Progress Jump	progress jump	fast forward video to specific time
Information	resolution, size, duration, bitrate	see the basic video information
Picuture & Sound	piture and sound mode	set picture and sound mode

Menu	Content	Mode	Function
Picture Mode	Standard/Soft/ Dynamic/Vivid/User	Contrast	Modify the picture parameters in the range 0-100
		Brightness	
		Sharpness	
		Color	
Sound Mode	Standard/Music/ Moive/News/Users	Bass	Modify the sound parameters in the range 0-100
		Treble	

2.3 Music Play Interface

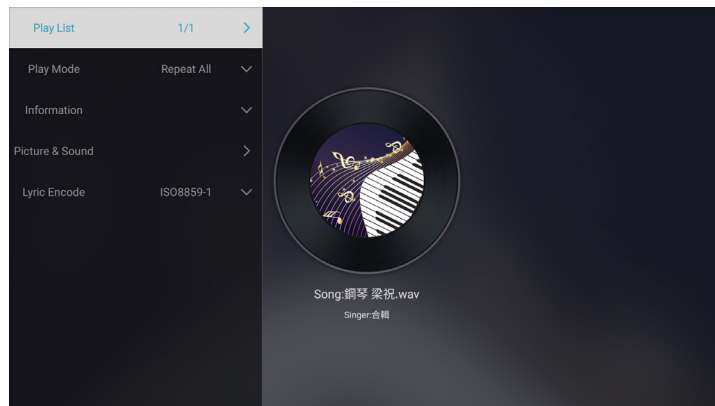

Playing setting	Include	Function
Play List	the musics of current folder	change music from the current folder
Play mode	repeat all, auto exit, repeat one, random, play list	change play mode
Information	size, duration, bitrate	see the basic music information
Picture&Sound	picture and sound mode	set picture and sound mode
Lyric Encode	various encoding standard	set encoding standard

2.4 Picture Play Interface

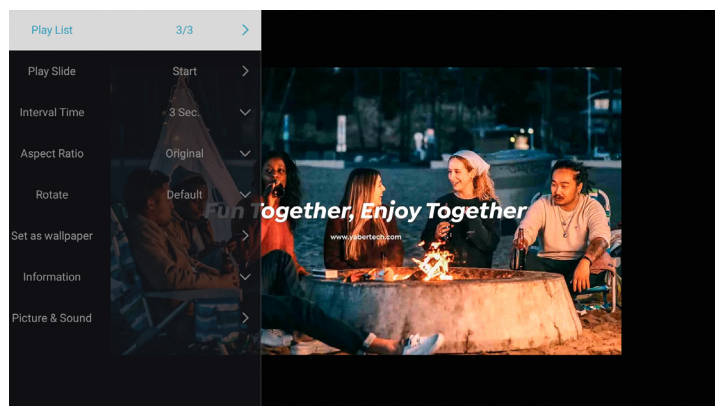

Playing setting	Include	Function
Play List	the pictures of current folder	change picture from the current folder
Play Slide	start, stop	start playing slides from the current folder
Interval Time	3 sec, 5 sec, 8 sec, 12 sec	set interval time of playing slides
Aspect Ratio	auto, full screen, zoom out, original, zoom1, zoom2	set picture aspect ratio
Rotate	default, rotate right, rotate left	rotate picture
Set as wallpaper	Set as wallpaper	Set as wallpaper
Information	resolution, size	see the basic picture information
Picture&Sound	picture and sound mode	set picture and sound mode

3. WiFi Setting

Wireless Connection

Warming Tips:

1. The fluency of screen mirroring with wireless connection will be affected by the network environment. A bandwidth of 100Mbit or more is recommended when using screen mirroring.
2. Make sure your mobile device is close to the projector when using wireless connection. A distance within 1 meter is recommended.
3. Some mobile devices may not support screen mirroring due to the compatibility.
4. Any questions, please feel free to email YABER via **aftersales@yabertch.com**.

3.1 iOS Cast (for iOS Devices)

1. Go to home page - Press the left button - Select the [Network] menu - Select [Wireless Net Mode] - Select your home WiFi from the list - Connect the Pro U6 projector to your home WiFi

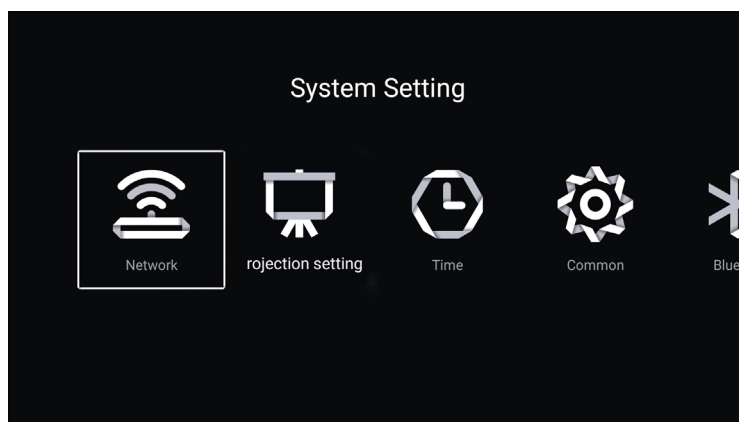
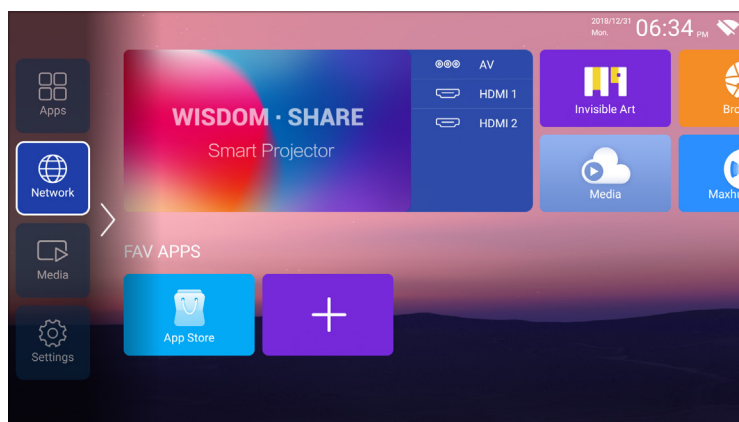

2. Select the [Settings] menu on your iOS device - Turn on the [Wi-Fi] function - Connect your iOS device to the same home network as the projector.

3. Open the [Control Center] on your iOS device - Select the [Screen Mirroring] function - Select and connect the iOS Cast receiver named [Pro U6-XXXX] - your iOS device screen will be displayed on the projection screen after 3 seconds.

3.2 MaxhubShare (for Android Devices)

1. Make sure Pro U6 projector and your Android device are connected with the same Wi-Fi, operations refer to the [1] and [2] from iOS Cast (for iOS Device)

2. Go to home - Select the [MaxhubShare] app - Press the OK button to enter the [MaxhubShare] app.

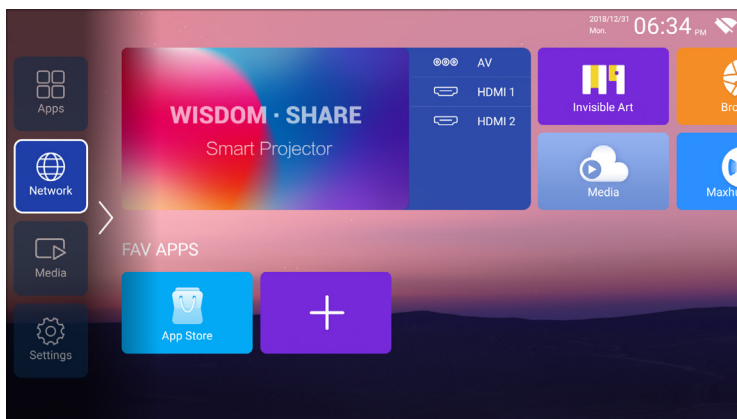

3. Scan the QR code and download the app on your Android device

4. Open [MaxhubShare] app on your Android device - Select TV named [Pro U6-XXXX] -Your Android device screen will be displayed on the projection screen after 3 seconds.

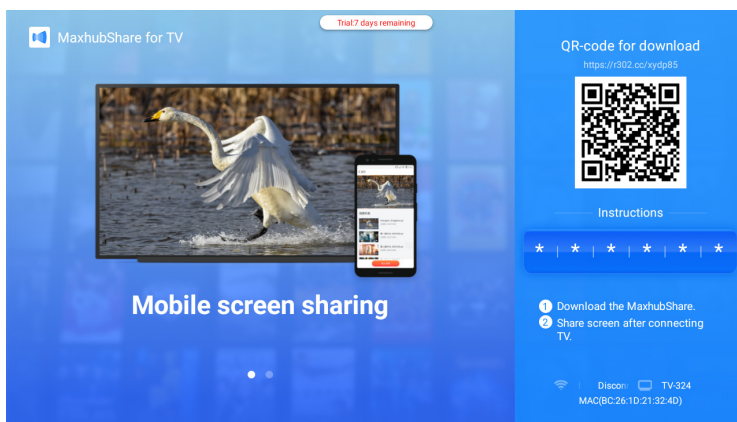

Note:

1. Different brands of Android phones have different operations for select Screen Mirroring Display, please refer to your phone's manual. [Multiscreen/Wireless display/WLAN display/Screen mirroring/Wireless projection/Smart view etc.]

2. Not all Android phones support this function. Please make sure it is supported before use.

4. Bluetooth Setting

Go to home page -- Select the [] menu -- Select the [Bluetooth] Option -- Open the Bluetooth function and your Bluetooth device -- Scan the Bluetooth devices nearby automatically -- Choose the Bluetooth device desired -- it will be paired and connected automatically.

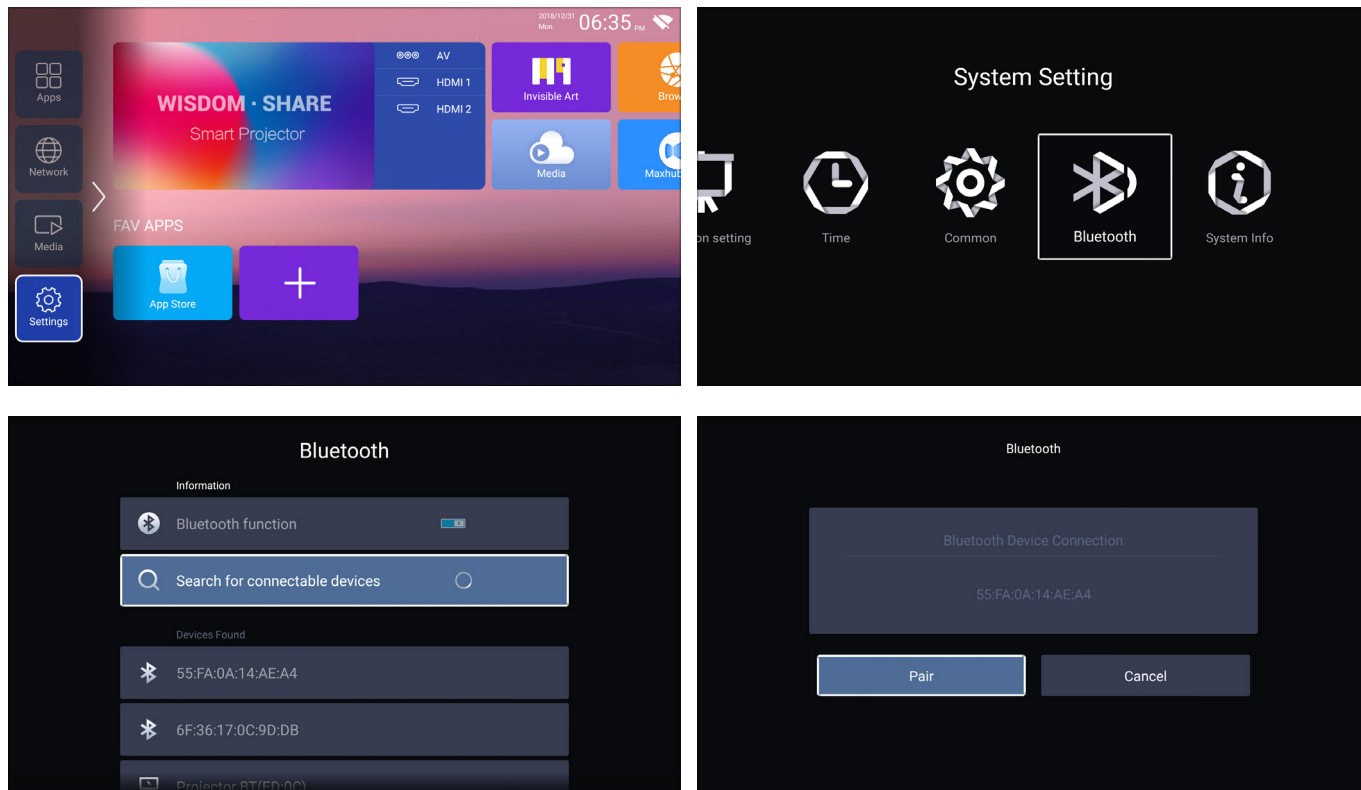

Note:

- 1.The Pro U6 projector is compatible with the Bluetooth headsets, Bluetooth speakers and AirPods, but not the Bluetooth keyboards or Bluetooth phones.
- 2.If you have any question, please feel free to email YABER via: aftersales@yabertech.com

5. Projector Image Setting

5.1 Projection Mode

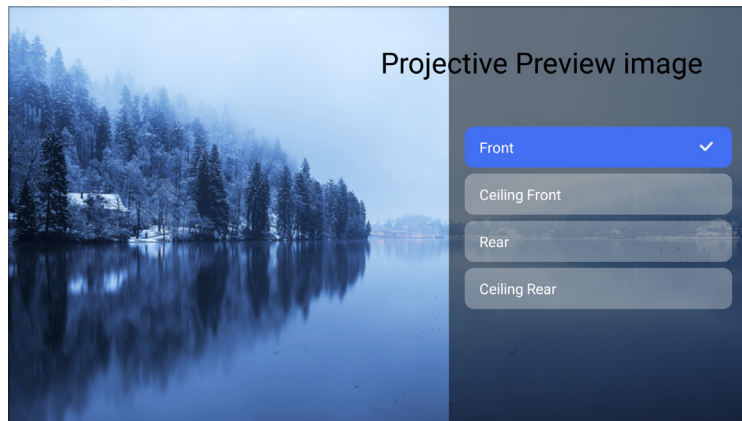
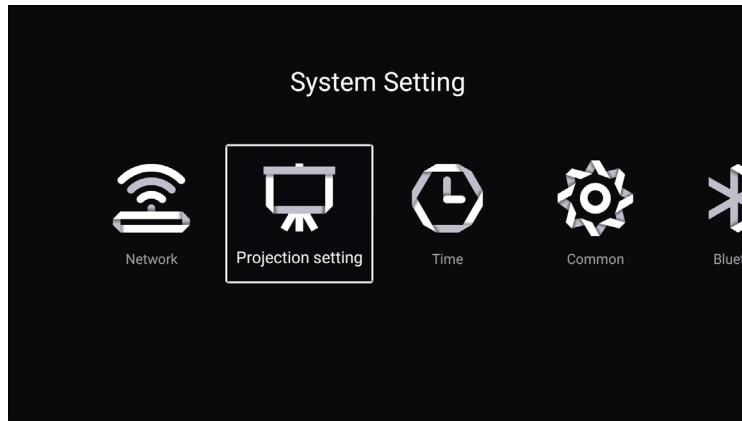

5.2 Keystone Advanced & 4-Point Keystone

5.2.1 Vertical Keystone Correction

Step 1: Select the [Sides] option in the [Advanced keystone correction] menu, then press the ▼ button to enter the [Four-sided trapezoid] menu.

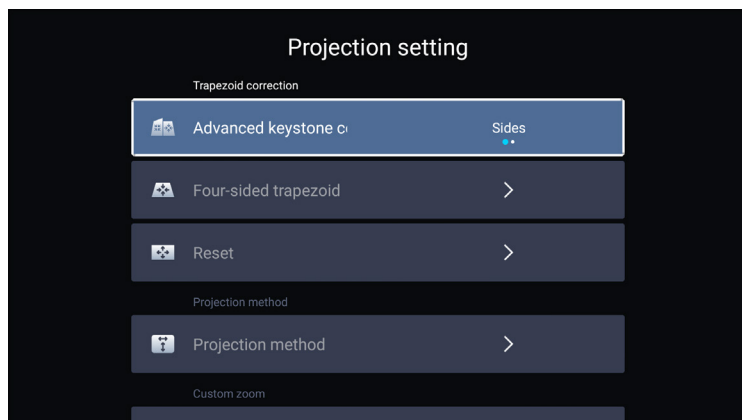

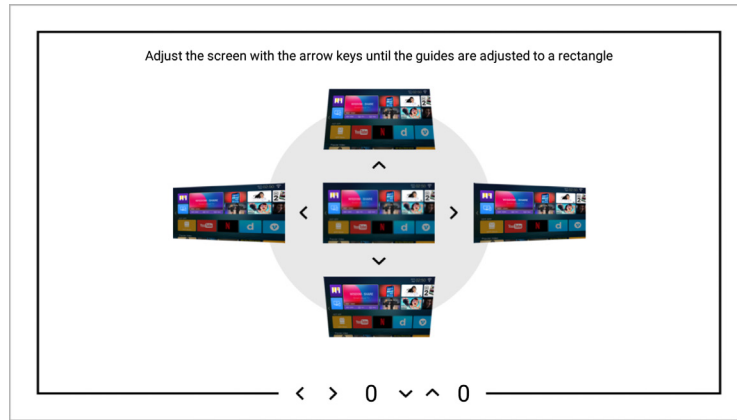

Step 2: If the projection image shows as (1), press the button on the remote controller or projector to increase the vertical parameter (-50~0), until to achieve the projection image (2).

Step 3: If the projection image shows as (3), then press the button on the remote controller or projector, and decrease the vertical parameter (0~50), until to achieve the projection image (4).

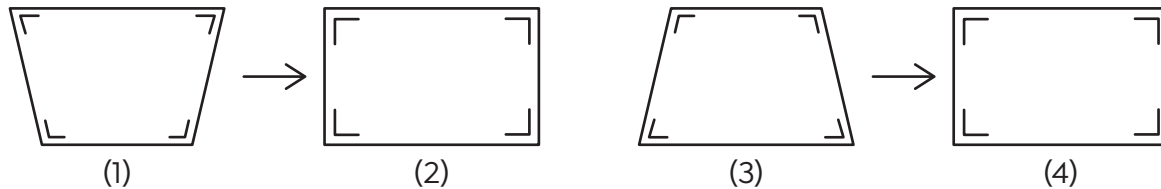

5.2.2 Horizontal & Vertical Keystone Correction

When the projection screen is not rectangular, it can be adjusted by 4-point keystone correction.

Step 1: Select the [Corners] option in the [Advanced keystone correction] menu;

Step 2: Press the button to select the [Square Trapezoid] menu, then press the [OK] bottom to enter the submenu.

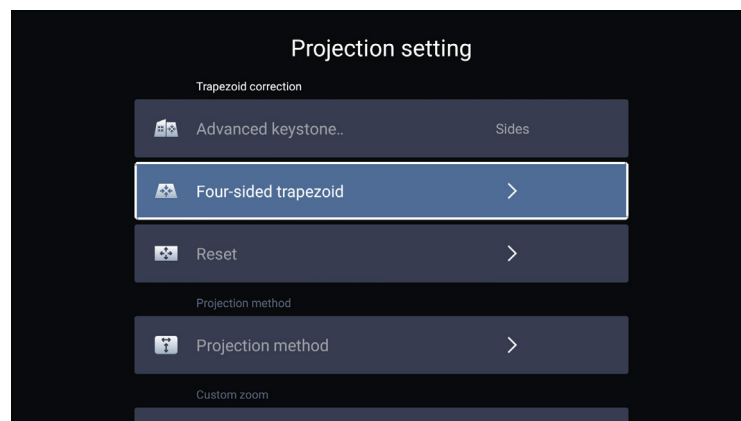

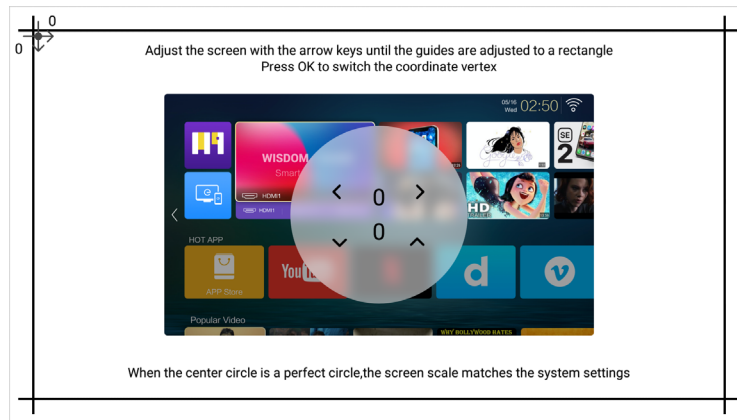

Step 3: Keep pressing the OK button on the remote control or projector to select the point .

Step 4: Press the arrow keys on the remote or projector to adjust the horizontal or vertical parameters, until the projection screen becomes the desired rectangle.

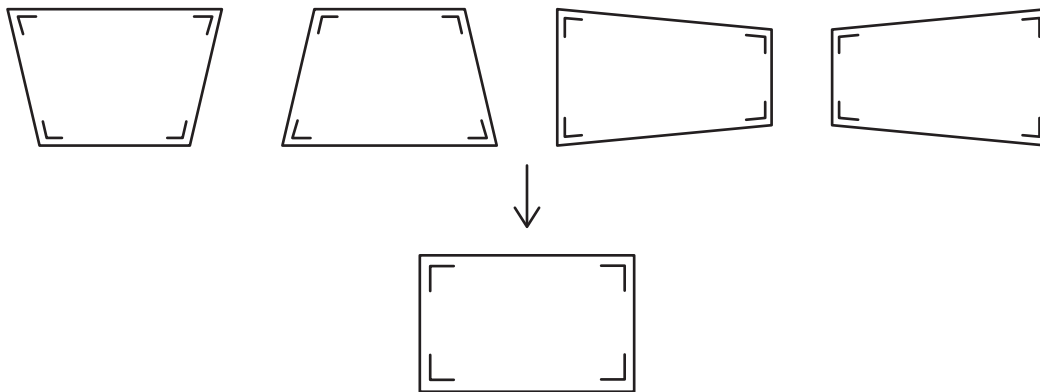

OK Pick point : Keep pressing the OK button on the remote control or projector, until the positioning icon  appears at the point desired, then release the button immediately.

↻ Adjustment : Press the arrow keys on the remote controller or projector to adjust the horizontal or vertical parameters.

↶ Back : Press the key on the remote controller to back to previous page.

☰ Reset : Press the key on the remote controller to restore the original parameters.

5.3 Digital Zoom

1. Open the [Custom Zoom] option.
2. Select [Zoom left and right] or [Zoom up and down].
3. Press the left or right button on the remote control.

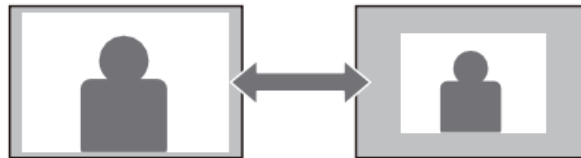
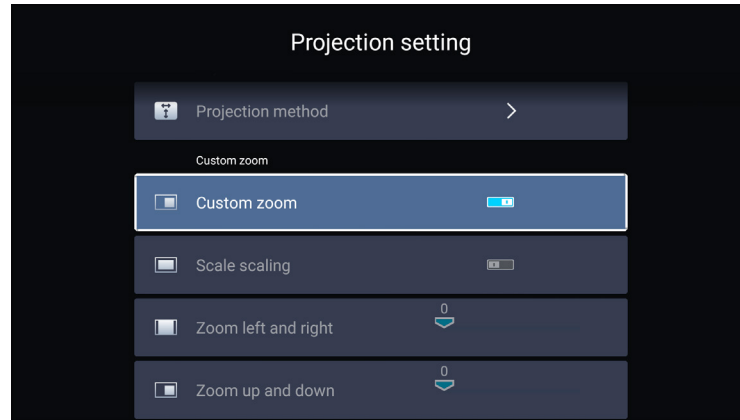

6. System Update



7. Common

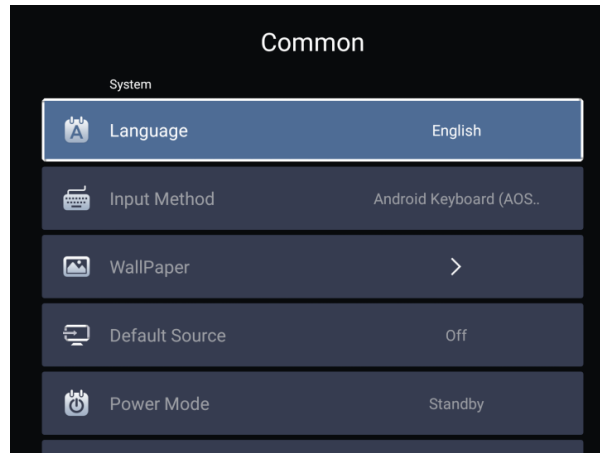

Menu	Function
Language	Set up system language
Input method	Set current input method
Wallpaper	Change wallpaper
Default source	Set up default source: AV, HDMI1, HDMI2
Power mode	Set power mode: standby, on, last
System Recovery	Recover the system and all data
The device name	Change projector name

About the Standby/on/last Power mode

Standby mode: When the projector is connected to the power, you need to press the button on the remote control to turn on the projector

On mode: When the projector is connected to the power, the projector will automatically turn on

Last mode: Memorise the last power mode - either standby mode or on mode

Signal Lines Connection

YABER Pro U6 projector has 7 interfaces, HDMI ports*2/ USB ports*2/ 3.5mm headphone output/ AV in/ RJ45(Ethernet port). Please select the correct connecting port to connect your device (PC, Phone, DVD Player, Sound bar, USB, PS4 etc.)

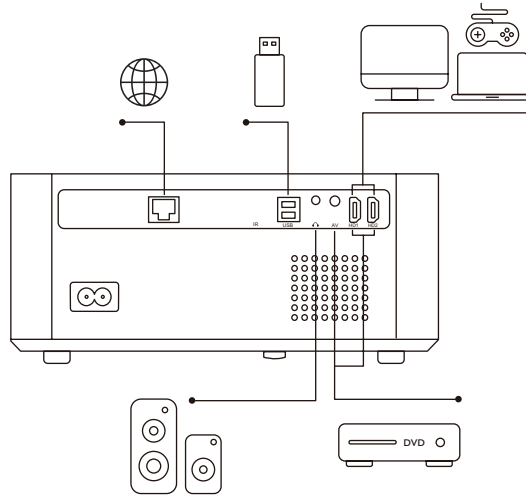

1. Connect the Devices via the HDMI ports

1. Connect your TV stick or laptop to any HDMI port of the projector.
2. Enter the home page to select the corresponding HDMI1 or HDMI2 as the signal source.

2. Connect to the DVD Player

Use the 3-in -1 AV cable in the package

1. Connect your TV stick or laptop to any HDMI port of the projector.
2. Connect the colorful female connectors to your DVD player's RCA cable with the 3-in-1 AV cable in the package.
3. Connect the black connector to the AV port of the projector, enter the home page to select [AV] as the signal source.

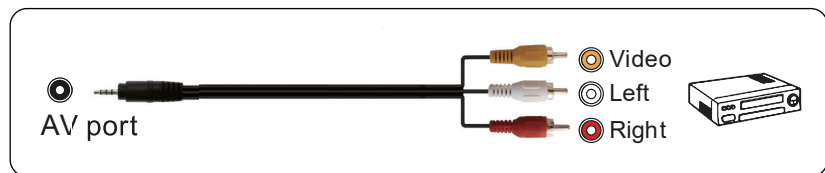
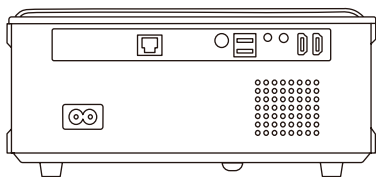

Or connect to the DVD Player with the HDMI cable in the package.

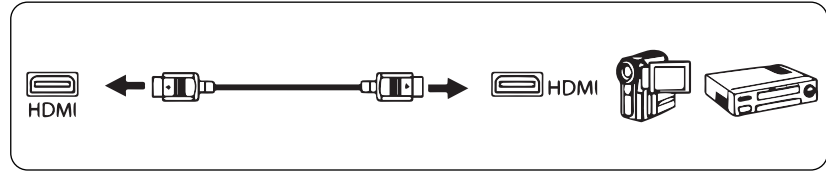
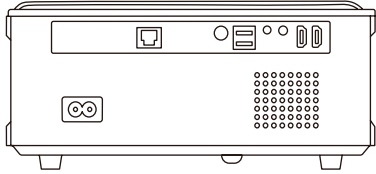

3. Connect to the Sound bar/Speaker

If your speaker has AUX port, please use your 3.5mm audio cable connect the projector and your speaker as the picture shows, enter the home page to select [AV] as the signal source.

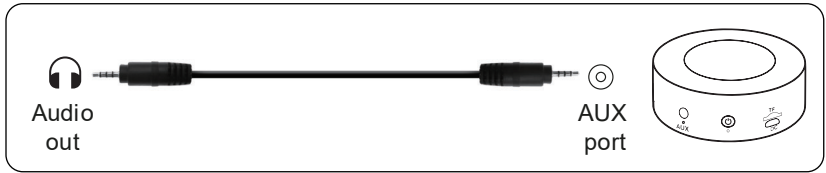
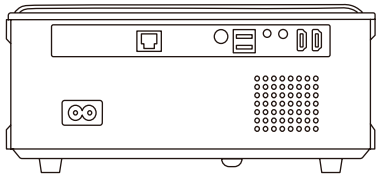

Safe Shutdown

1. Press the  button on the projector or remote controller, then press OK key to power off the projector.
2. Unplug the power cord of the projector.
3. Cover the lens and store the projector in a cool and dry place.

Warranty

Thank you so much for your purchase and support! We provide 3-year warranty for Pro U6 projector. If you have any questions, please feel free to contact us via

purchased from Amazon: support@yabertech.com

purchased from others: aftersales@yabertch.com

Declaration of Conformity

We (EU based importer is responsible for this declaration)

Prolinx GmbH
(Company name)

Brehmstr.56, 40239 Duesseldorf, Germany
(Company address)

declare under our sole responsibility that the product

Trade name: Yaber

Equipment: Entertainment Projector

Model No. : V5

to which this declaration relates is in conformity with the essential requirement set out in the Council Directive on the Approximation of the laws of the Member States relating to RED Directive(2014/53/EU) & RoHS(2011/65/EU) product is responsible to affix **CE** marking, the following standards were applied:

EN 62368-1:2014+A11:2017
EN IEC 62311:2020
ETSI EN 301 489-1 V2.2.3(2019-11)
ETSI EN 301 489-17 V3.2.4(2020-09)
ETSI EN 301 489-3 V2.1.1(2019-03)
EN 55032:2015+A11:2020
EN 55035:2017 +A11:2020
EN IEC 61000-3-2:2019
EN 61000-3-3:2013+A1:2019
ETSI EN 300 328 V2.2.2(2019-07)
ETSI EN 301 893 V2.1.1(2017-05)
ETSI EN 300 440 V2.2.1(2018-07)
IEC62321-3-1:2013
IEC62321-4:2013
IEC62321-5:2013
IEC62321-6:2015
IEC62321-7-1:2015
IEC62321-7-2:2017
IEC62321-8:2017

Full Name: George.wang Position: Approbation Manager

Signature:  Place/Date: Shenzhen,China/Mar.22-2022



Scan and download the PDF user manual

Where to Get More Help

✉ Support@yabertech.com ✉ Aftersales@yabertch.com 🌐 www.yaberglobal.com

▶ [@Yaber Entertainment Projector](#) 📺 [@Yaber Entertainment Projector](#)