



LONDON

## MODULAR SOFA

# Dylan

This contemporary modular sofa can easily be expanded and reconfigured to suit your living space. The fixed seat and back cushions are plumped with generous layers of feather and down. Scattered cushions available separately.



## COMPOSITION 1

ST-01-MS-03-C1

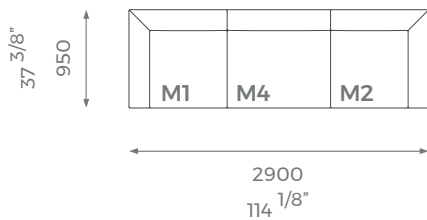
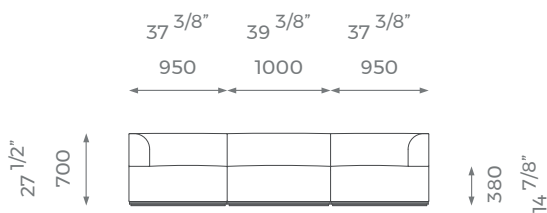

PLAIN  
21m



PATTERN/VELVET  
24m



LEATHER  
35 sq m

## DETAILS

- Wooden plinth.
- 10 years construction guarantee (for further information please contact our sales team).

## BESPOKE

This piece has an array of customization options, you can order a CAD technical drawing (additional cost) or/and give property access for fine measuring checks to ensure maximum precision on your bespoke order.

For further questions feel free to contact our sales team and with the help of our experts we help you solve all your questions.

## COMPOSITION 2 (RIGHT)

ST-01-MS-03-C2R

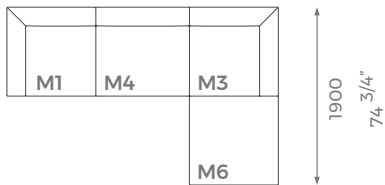
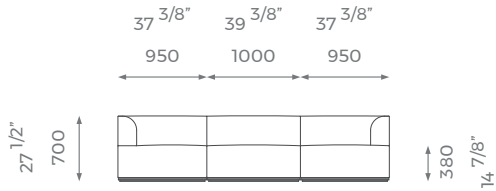

## COMPOSITION 2 (LEFT)

ST-01-MS-03-C2L

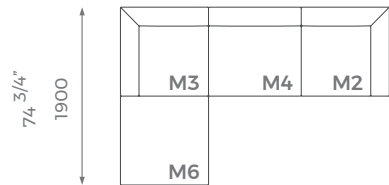
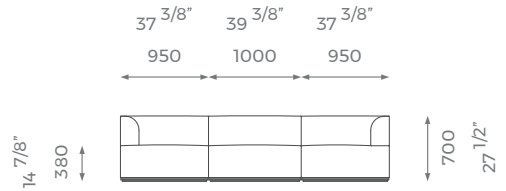

## COMPOSITION 3

ST-01-MS-03-C3

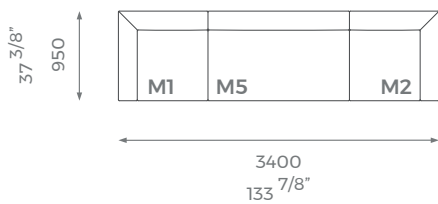
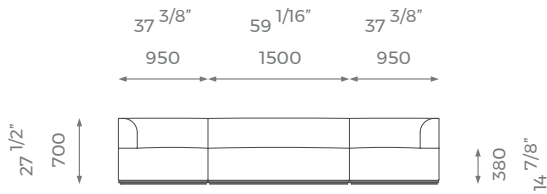

## COMPOSITION 4 (RIGHT)

ST-01-MS-03-C4R

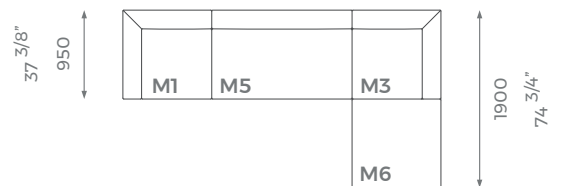
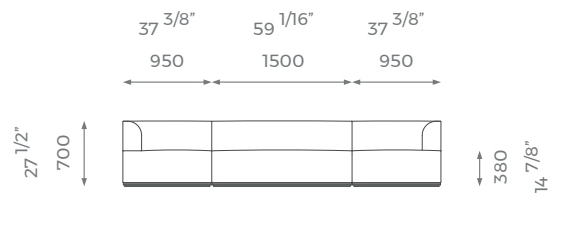

## COMPOSITION 4 (LEFT)

ST-01-MS-03-C4L

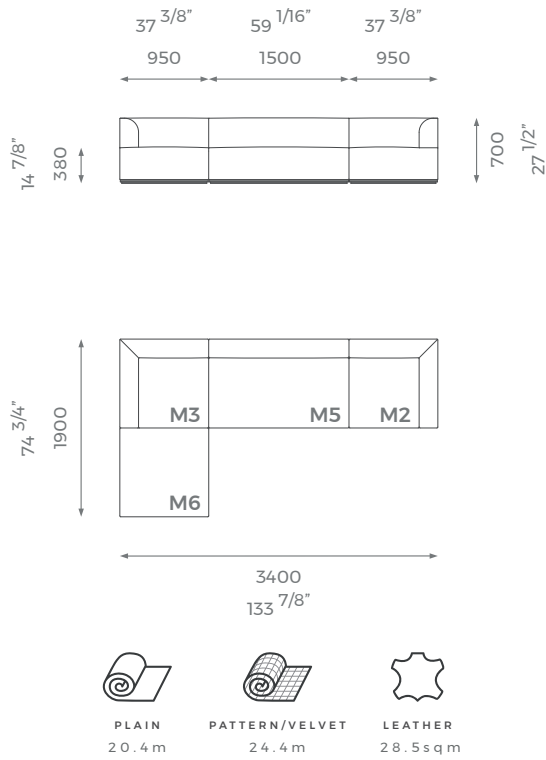

## COMPOSITION 5 (RIGHT)

ST-01-MS-03-C5R

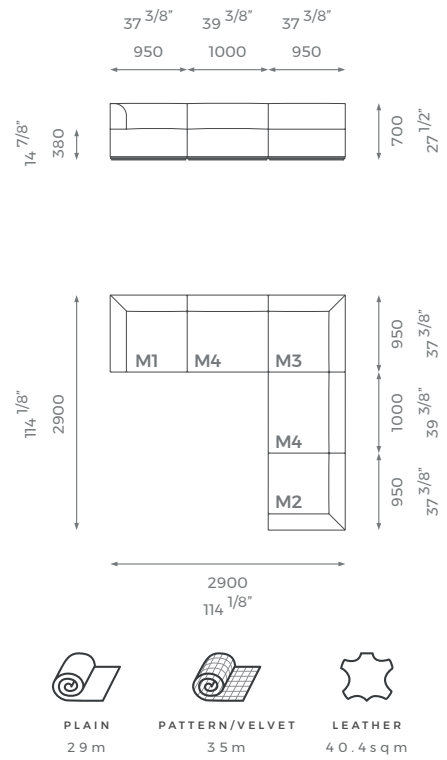

## COMPOSITION 5 (LEFT)

ST-01-MS-03-C5L

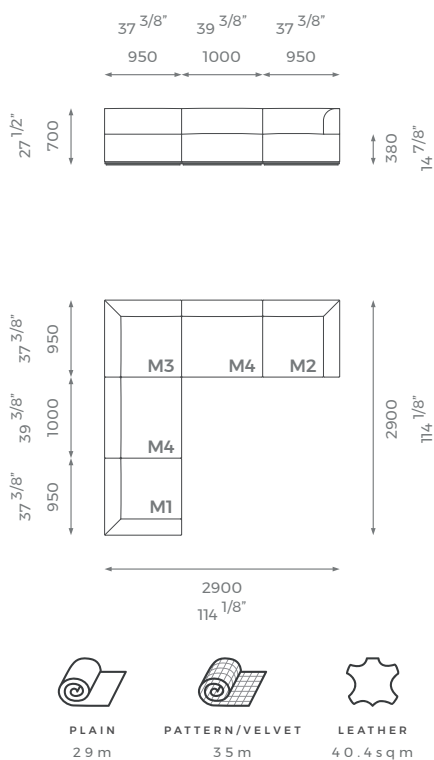

## COMPOSITION 6 (RIGHT)

ST-01-MS-03-C6R

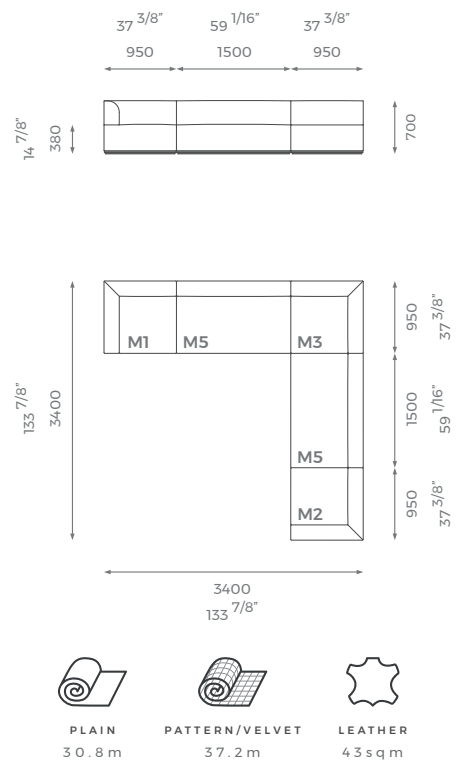



LONDON

### COMPOSITION 6 (LEFT)

ST-01-MS-03-C6L

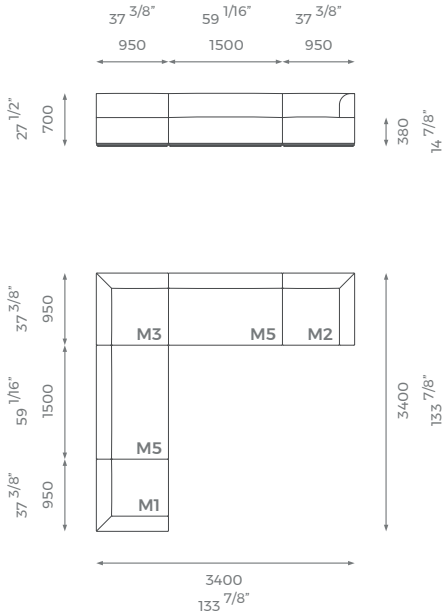

PLAIN  
30.8 m



PATTERN/VELVET  
37.2 m



LEATHER  
43 sq m

### MODULE 1

ST-01-MS-03-M1

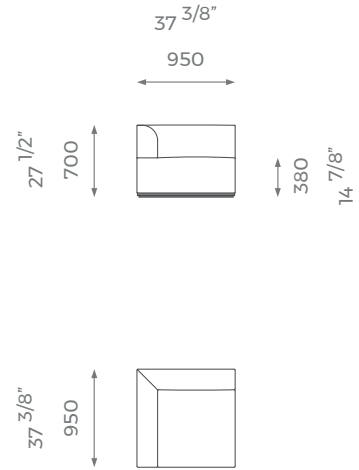

PLAIN  
5.6 m



PATTERN/VELVET  
6.7 m



LEATHER  
7.8 sq m

### MODULE 2

ST-01-MS-03-M2

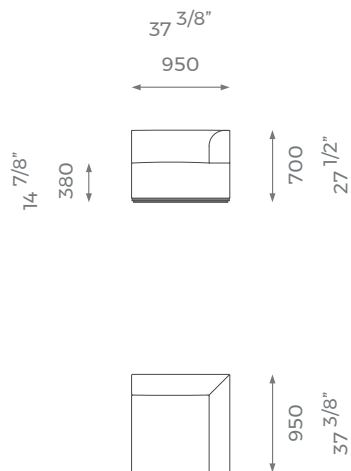

PLAIN  
5.6 m



PATTERN/VELVET  
6.7 m



LEATHER  
7.8 sq m

### MODULE 3

ST-01-MS-03-M3

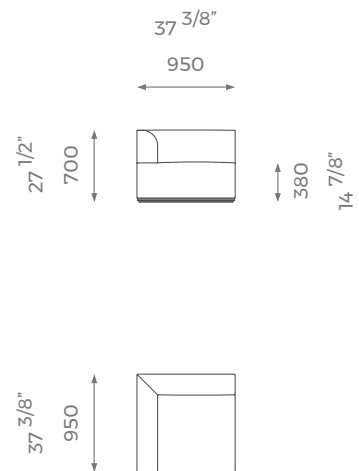

PLAIN  
5.6 m



PATTERN/VELVET  
6.7 m



LEATHER  
7.8 sq m



LONDON

### MODULE 4

ST-01-MS-03-M4

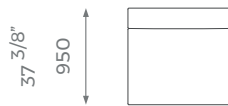
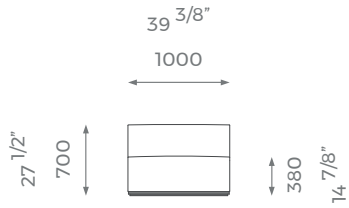

PLAIN  
6.1m



PATTERN/VELVET  
7.3m



LEATHER  
8.5sqm

### MODULE 5

ST-01-MS-03-M5

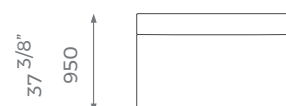
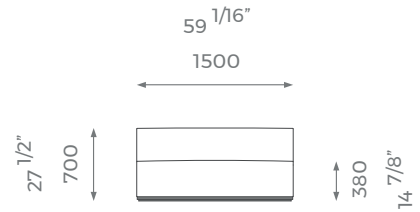

PLAIN  
7m



PATTERN/VELVET  
8.4m



LEATHER  
9.8sqm

### MODULE 6

ST-01-MS-03-M6

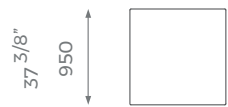
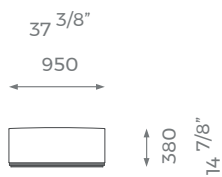

PLAIN  
2.2m



PATTERN/VELVET  
2.6m



LEATHER  
3.1sqm

### MODULE 7

ST-01-MS-03-M7

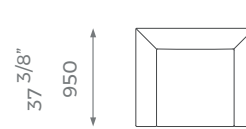
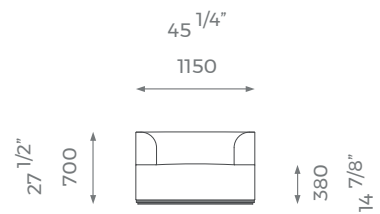

PLAIN  
6.5m



PATTERN/VELVET  
7.8m



LEATHER  
9.1sqm