

Gallant™

Instruction and Reference Guide

Model BLGT15



FOR THE LOVE OF SEWING

To register your machine warranty and receive Baby Lock product updates and offers, go to babylock.com/login. If you have questions with registration, visit your Authorized Baby Lock Retailer.





Baby Lock Consumer Helpline: 800-313-4110

www.BabyLock.com

Brought to You by Tacony Corporation®

How to Use This Manual

Special Information

-  **NOTE:** A NOTE indicates important information that helps you make better use of your Baby Lock product.
-  **IMPORTANT:** An IMPORTANT note provides information that is essential to properly using your Baby Lock product.
-  **CAUTION:** A CAUTION indicates a potential for causing harm to your quilting machine, the quilt, or to yourself.
-  **QUILTING TIP:** Baby Lock educators share tips to help get you started quilting.

Contents

How to Use this Manual	2
Congratulations on Your Purchase!	4
What's Included with Your Machine	4
Important Safety Information	5
About Your Machine	10
General Specifications	10
Get to Know Your Gallant	11
Installation and Setup	14
Carriage	14
Power Cord	15
Front Handlebars	15
Spool Pin and Thread Mast	16
Machine Head USB Port (Built-in)	16
Optional Accessories	17
Rear Handlebars and Laser	17
Horizontal Spool Pin	19
Gallant Ruler Base	20
Using Your Machine	21
Power Switch	21
Lighting	21
Machine Needle	21
Hopping Feet	23

Optional Accessory Feet	24
Bobbin and Bobbin Tension	24
Threading the Machine	26
Threading the Needle with the Needle Threader.....	28
Top Tension.....	29
Tension Quick Start Guide	30
Quilting with the Gallant	31
Preparing to Quilt	31
Free-Motion Quilting.....	33
Updating the Gallant Software.....	33
Machine Maintenance.....	34
Clean and Oil Your Gallant.....	34
Maintenance Schedule	34
Navigating the Screens	35
Home Screen	35
Home Screen - Variations	36
Gallant Screen Layouts	38
Menu.....	40
Stitch Modes	41
Cruise Stitch Mode - Setting Cruise Speed	42
Needle Stop - Up or Down.....	43
Lights	44
Over-speed Alarm.....	44
Stitch Count.....	45
Diagnostics	46
Update.....	48
Information	49
Home.....	49
Alerts	50
Troubleshooting	53
Appendix 1	58
Federal Communications Commissions (FCC) Declaration of Conformity (For USA Only).....	58
Canadian Department of Communications Compliance Statement (For Canada Only).....	58
Radio Interference (Other than USA and Canada)	58

-  **IMPORTANT:** The packaging materials are designed to prevent the machine from being damaged. Keep the carton and packing materials in case you need to bring this machine to the dealer, send it for repair, or otherwise transport it. If you don't pack the machine properly or if you don't use the correct packaging materials, the machine could be damaged. Baby Lock is not liable for damage that occurs during return shipping.

Congratulations On Your Purchase!

You haven't just purchased a quilting machine, you've joined the Baby Lock family and we welcome you. You have acquired the most advanced quilting machine available in today's market.

Baby Lock is committed to innovation, reliability, customer service, and education. We are committed to your quilting success. With that in mind, we invite you to bookmark our website: www.babylock.com, and we invite you to visit to learn more about the art of quilting.

Remember, if you ever have questions, your local Baby Lock authorized retailer can help you. If the retailer is not available, contact Baby Lock Product Support at www.babylock.com/support/contact or by calling us at 800-313-4110.

Keep the carton and packing materials. You will need them if you ever need to return the machine to the retailer or send it for repair. If you don't pack the machine properly or if you don't use the correct packaging materials, the machine could be damaged. Baby Lock is not liable for damage that occurs during return shipping.

What's Included With Your Machine

Part name	Part Code
• Quilting Machine (including carriage, front handlebars)	BLGT15A
• Bobbin Winder	HG00480-BL
• Bobbins (5) one installed in bobbin case	BLJ-BOB (3 pkg)
• Bobbin case	JW000586
• Needle (134) size 100/16 (pack of 10)	134FG-100
• Needle (134) size 110/18 (pack of 10)	134FG-110
• Spool pin	QM10292
• Thread Mast	QM11024
• EZ Pen Oiler	JW010272
• Power cord (locking)	QM20304
• Screwdriver (bobbin case)	JW010269
• Wrench, 8mm/10mm combined	QM40233
• Needle Threader	QM40042
• 2.5mm L hex wrench	QM10286
• 3 and 4mm L hex wrench	QM10288
• Replacement O-ring	QM29760-7
• Quick Reference Card	QM11061-BL
• Ruler Foot (installed on machine)	QM10511
• Open-toe Foot	QM10510
• Lint brush	JW010270

Important Safety Information

This device complies with Part 15 of the FCC Rules. Operation is subject to the following two conditions: (1) This device may not cause harmful interference, and (2) this device must accept any interference received, including interference that may cause undesired operation. See the full Declaration of Conformity in the Appendix.

- **IMPORTANT:** Do not operate your Gallant quilting machine until you have completely read the information contained in this manual. Please keep all packaging and order information for warranty purposes.

IMPORTANT SAFETY INSTRUCTIONS

Read all instructions before using this machine.

When using this machine, basic safety precautions should always be followed.

DANGER — To reduce the risk of electric shock:

- A quilting machine should never be left unattended when plugged in. Always unplug the machine from the electrical outlet immediately after using and before cleaning.

DANGER — Pour réduire le risque de choc électrique :

- Une machine à quilter ne doit jamais être laissée sans surveillance lorsqu'elle est branchée. Débranchez toujours la machine de la prise électrique immédiatement après usage et avant de la nettoyer.

WARNING — To reduce the risk of burns, fire, electric shock, or injury to persons:

- It is recommended to have two people when lifting your Gallant. Always lift from the throat of the machine, not from the handlebars or the needle bar area.
- Always unplug the Gallant from the electrical outlet when performing any maintenance, changing the needle, removing thread locks, or when left unattended.
- Do not unplug by pulling on the cord. To unplug, grasp the plug, not the cord.
- Keep fingers away from all moving parts. Use caution around the needle.
- Change the needle often. Do not use bent or dull needles. "Every quilt deserves a new needle" is our motto.
- Switch the machine to the off (or symbol O), position to turn it off when making any adjustments in the needle area, such as threading the needle, changing the needle, changing the bobbin, or changing the hopping foot.
- Never drop or insert foreign objects into any opening.
- The Gallant should only be used indoors, away from moisture.
- The Gallant should not be stored or used in extreme temperatures.
- Use the Gallant only for its intended purpose as described in this manual.

- To disconnect from the wall outlet, push the switch to the off position, then remove the plug from outlet, pulling from the plug, not the cord. Never operate the Gallant if the cord is damaged or not working correctly. If a mechanical or electrical problem is encountered, return the Gallant to the nearest authorized Baby Lock retailer or to Baby Lock for examination, repair, electrical or mechanical adjustment.
- It is not recommended that the Gallant quilting machine be used with any machine quilting frame other than those recommended by Baby Lock.
- Use this quilting machine only for its intended purpose as described in this manual. Use only attachments recommended by Baby Lock as contained in this manual.
- Never operate the machine with any ventilation openings blocked. Keep openings of the machine free from the accumulation of lint, dust, and loose fabric.
- Do not operate where aerosol products are being used or where oxygen is being administered.
- Do not move the machine across the fabric at an excessive speed while stitching. This may deflect the needle enough to cause it to break.
- Use only needles designed for free motion quilting and recommended by Baby Lock for this machine. Use the specific needle system recommended by Baby Lock.
- Children should not play with the machine. Close attention and supervision is necessary when this machine is used by or near children.
- This sewing machine may be used by children age 8 years and above and persons with reduced physical, sensory, or mental capabilities or lack of experience and knowledge if they have been given supervision and instruction concerning use of the machine in a safe way and understand the hazards involved.
- Cleaning and user maintenance should not be performed by children without supervision.

AVERTISSEMENT — Pour réduire le risque de brûlures, d'incendie, de choc électrique ou de blessures.

- La Gallant est lourde. Ne tentez jamais de la soulever seule. Utilisez toujours deux personnes pour la soulever. Soulevez toujours la machine à partir de la gorge, non pas à partir des poignées.
- Débranchez toujours la Gallant de la prise électrique lors des travaux d'entretien, du changement d'aiguille, de la suppression des blocages de fil, ou lorsqu'elle est laissée sans surveillance.
- Ne pas débrancher en tirant sur le cordon. Pour débrancher, saisir la fiche, non le cordon.
- N'approchez pas les doigts des parties mobiles. Faites preuve de prudence lorsque vous vous approchez de l'aiguille ou de composants externes tranchants.
- Changez souvent d'aiguille. N'utilisez pas d'aiguilles tordues ou émoussées. "Chaque quilt mérite une nouvelle aiguille".
- Mettez la machine sur la position 0 ou de symbole d'arrêt pour l'éteindre lorsque vous effectuez des réglages dans la zone de l'aiguille : enfilage de l'aiguille, changement d'aiguille, bobinage de la canette, changement de pied, etc.
- Ne faites jamais tomber et n'insérez jamais d'objets étrangers dans une ouverture.
- La Gallant doit uniquement être utilisée à l'intérieur dans un endroit non humide.
- La Gallant ne doit pas être rangée ou utilisée à des températures extrêmes.
- Utilisez la Gallant uniquement pour l'usage prévu indiqué dans ce manuel.
- Pour débrancher la machine de la prise murale, mettez l'interrupteur sur arrêt, puis retirez la fiche de la prise en tirant à partir de la fiche et non du cordon. N'utilisez jamais la Gallant si le cordon est endommagé ou ne fonctionne pas correctement. En cas de problème mécanique ou électrique, renvoyez la Gallant au centre de service agréé le plus proche ou au fabricant pour inspection, réparation ou réglage électrique ou mécanique.

- Il est déconseillé d'utiliser la machine à quilter Gallant avec un autre cadre de machine à quilter que ceux recommandés par Baby Lock.
- Utilisez cette machine à quilter uniquement pour l'usage prévu décrit dans ce manuel. Utilisez uniquement les accessoires recommandés par le fabricant décrits dans ce manuel.
- Ne jamais utiliser la machine si des ouvertures d'air sont bloquées. Gardez les ouvertures de ventilation de la machine exemptes d'accumulation de peluches, poussières et morceaux de tissu.
- Ne pas utiliser là où des aérosols (vaporisateurs) sont utilisés ou de l'oxygène est administré.
- Ne pas tirer ni pousser trop fort la machine sur le tissu lors de l'exécution des points. Cela pourrait provoquer une déviation de l'aiguille et en entraîner la fracture.
- N'utilisez que les aiguilles conçues pour le quilting en piqué libre et recommandées par Baby Lock pour cette machine. D'autres types d'aiguilles risqueraient de se fracturer au cours d'un quilting normal.
- Ne pas laisser les enfants jouer avec la machine. Une attention particulière est nécessaire lorsque cette machine est utilisée par ou à proximité d'enfants.
- Cette machine peut être utilisée par des enfants de 8 ans et plus, ainsi que par des personnes atteintes d'un déficit physique, sensoriel ou mental, peu expérimentées ou ayant peu de connaissances, à condition que ces personnes reçoivent les instructions de sécurité et la supervision nécessaires à l'utilisation de la machine et qu'elles comprennent les risques encourus.
- Les travaux de maintenance et de nettoyage ne peuvent pas être effectués par des enfants sans supervision.

Save these instructions

This machine is intended for household or commercial use.

Disclaimer

Baby Lock and its Retailers are in no way legally responsible or liable for damage to the Gallant when used improperly or not in accordance with the guidelines stated in this manual or when used on machine quilting frames not recommended by Baby Lock.

To use the machine safely

1. Carefully watch the needle when sewing. Do not touch the hand wheel, take up lever, needle, or other moving parts while the machine is running.
2. Turn the machine off and unplug the cord in the following cases:
 - when you have finished using the machine
 - when you replace or remove the needle or any other part
 - when you check or clean the machine
 - when you leave the machine unattended
3. Do not use extension cords. Connect the machine directly to the wall outlet or to a surge protector or UPS (Uninterrupted Power Source) that connects directly to the wall outlet.

To increase the life of your machine

1. Do not store your Gallant in areas exposed to direct sunlight or high humidity. Never use or store the machine near a heater, an iron, a halogen lamp or other hot items.
2. Use only neutral soaps or detergents to clean the machine. Never use benzene, solvents or scouring powders. They can damage the case and the machine. A damp microfiber cloth is a good choice.
3. Do not drop or bump the machine.
4. Always consult the manual to replace or fix the hopping foot, needle or any other part of the machine. If necessary, contact an authorized Baby Lock retailer or Baby Lock Product Support at 800-313-4110.

Optional U.S. Grounding for Customers with 120 VAC Connections

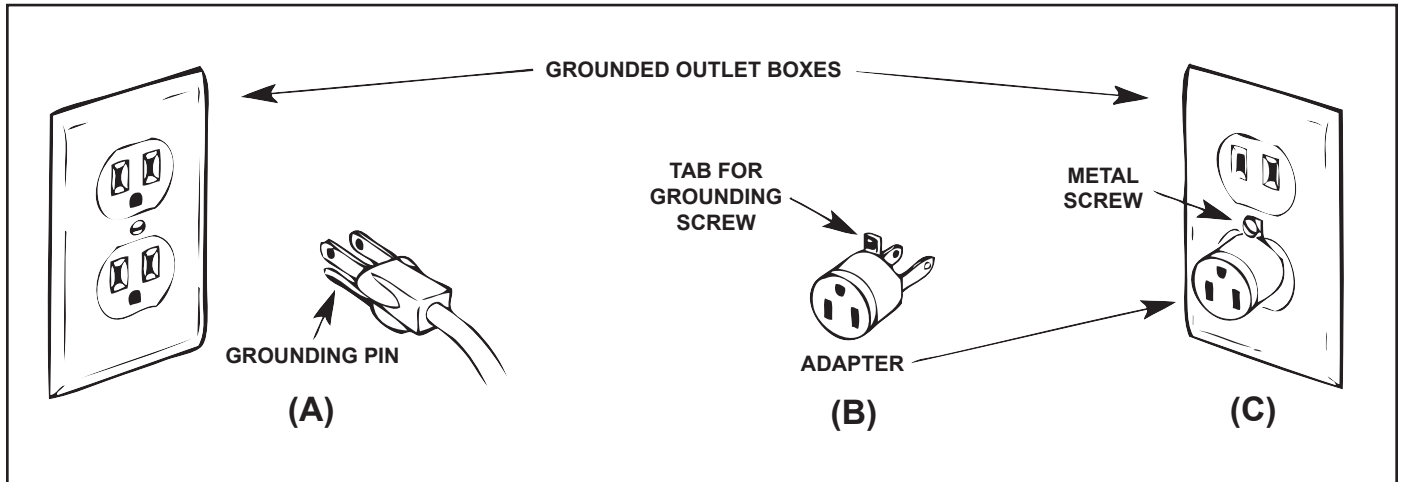

This product is for use on a nominal 120 V or nominal 220 V circuit, and has a grounding plug that looks like the plug illustrated in sketch A above. A temporary adapter, which looks like the adapter illustrated in sketches B and C, may be used to connect this plug to a 2-pole receptacle as shown in sketch C if a properly grounded outlet is not available. The temporary adapter should be used only until a properly grounded outlet can be installed by a qualified electrician. The green colored rigid ear, lug, and the like, extending from the adapter, must be connected to a permanent ground such as a properly grounded outlet box cover. Whenever the adapter is used, it must be held in place by the metal screw.

- **IMPORTANT:** In Canada, the use of a temporary adapter is not permitted by the Canadian Electric Code.

To repair or adjust the machine

If the machine is not functioning properly or needs adjustment, first check the troubleshooting chart in the appendix to inspect and adjust the machine yourself. For more product information and updates, visit our website at www.babylock.com.

The contents of this manual and product specifications are subject to change without prior notice.

About Your Machine

General Specifications

The Gallant uses high-tech electronics and an innovative user interface to offer greater functionality and ease of operation to home quilters than ever before conceived in the quilting industry. The Gallant quilting machine is a high quality machine that incorporates robust design features and is easy to maintain.

Sewing Opening Dimensions	(210 mm X 383 mm) 8.25 inches X 15.00 inches
Sewing Speed	Manual Mode: from 25 stitches per minute to 1800 stitches per minute Regulated Mode: from 0 stitches per minute to full speed Cruise Speed 50 to 800 stitches per minute.
Stitches Per Inch	4 stitches to 18 stitches per inch in regulated mode
Needle System	134
Needle Sizes (recommended)	From 80/12 to 130/21
Hook System	Rotary, Horizontal Axis, M-class bobbin
Bobbin Type	Aluminum, Class M
Bobbin Case	Type MF
Motor Type	Brushless DC, servo controlled
Needle Positioning	Up and down, walking stitch
Electrical Power	Maximum 200 watts, 50-60Hz, 100-240 VAC Average 0.9 ampere at 115 VAC, 60Hz This machine conforms to UL and international safety standards for sewing machines and US and international laws for electromagnetic compliance.
Display	1.44" (128 x 128 pixels) Built-in machine face cover
Sew Foot Stroke/Lift	5 mm
Needle Bar Stroke	35.3 mm
Take-Up Stroke	73 mm
Lubrication, main components	Kluber Lube, permanent
Lubrication of hook	Velocite 10, Texaco 22

Get to Know Your Gallant

Left side view (picture shown with optional rear handlebars)

1. Spool pin
2. Thread mast
3. Rear handlebars (optional accessory)
4. Machine encoder connector
5. Machine encoder
6. Laser pin (optional accessory)
7. Front handlebars
8. Front display
9. USB port

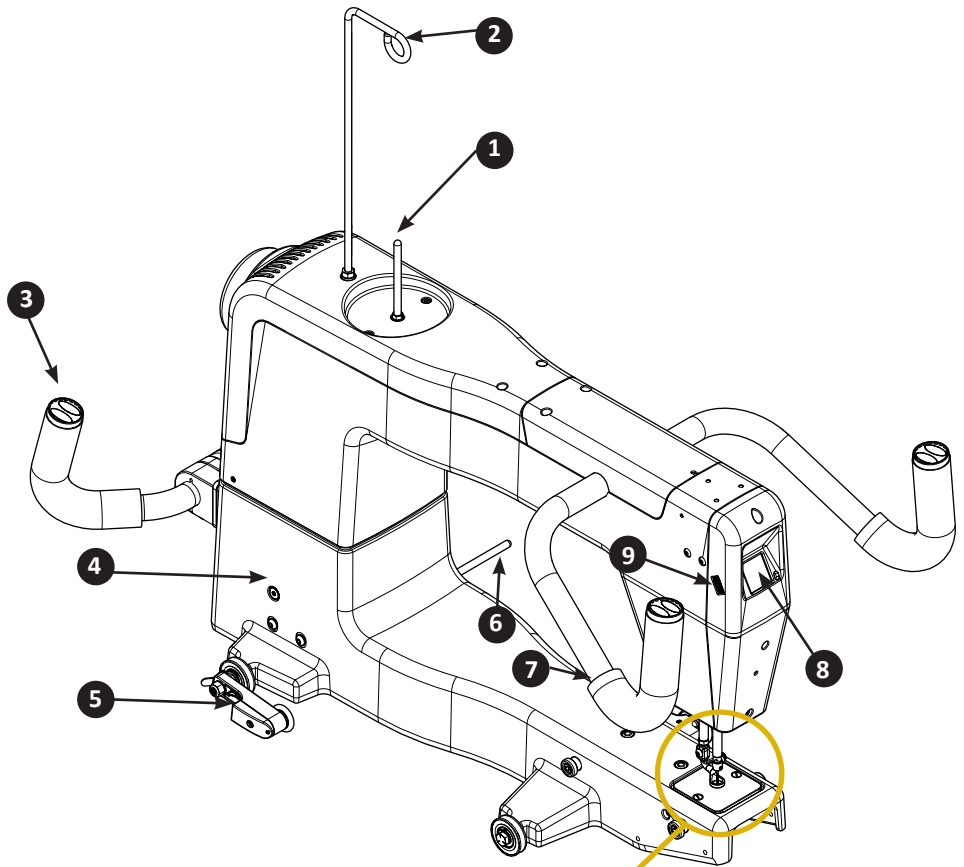

Close-up view of needle area

10. Presser bar
11. Presser bar jam nut
12. Hopping foot mounting screw
13. Ruler foot
14. Needle plate
15. Needle plate screw
16. Ruler base post (optional accessory)
17. Needle
18. Needle bar thread guide
19. Needle stop sight hole
20. Needle bar clamp screw
21. Needle bar

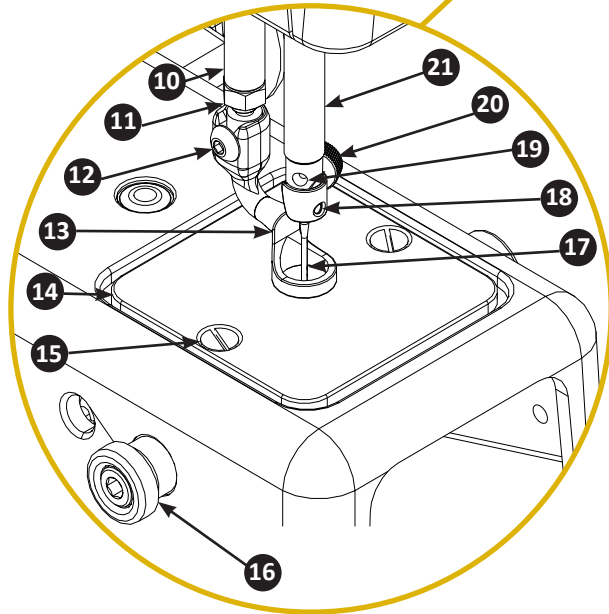

Right side view (picture shown without handlebars)

- ➔ **IMPORTANT:** Only rotate the hand wheel toward you from this side of the machine. From the rear of the machine, it will rotate counter clockwise

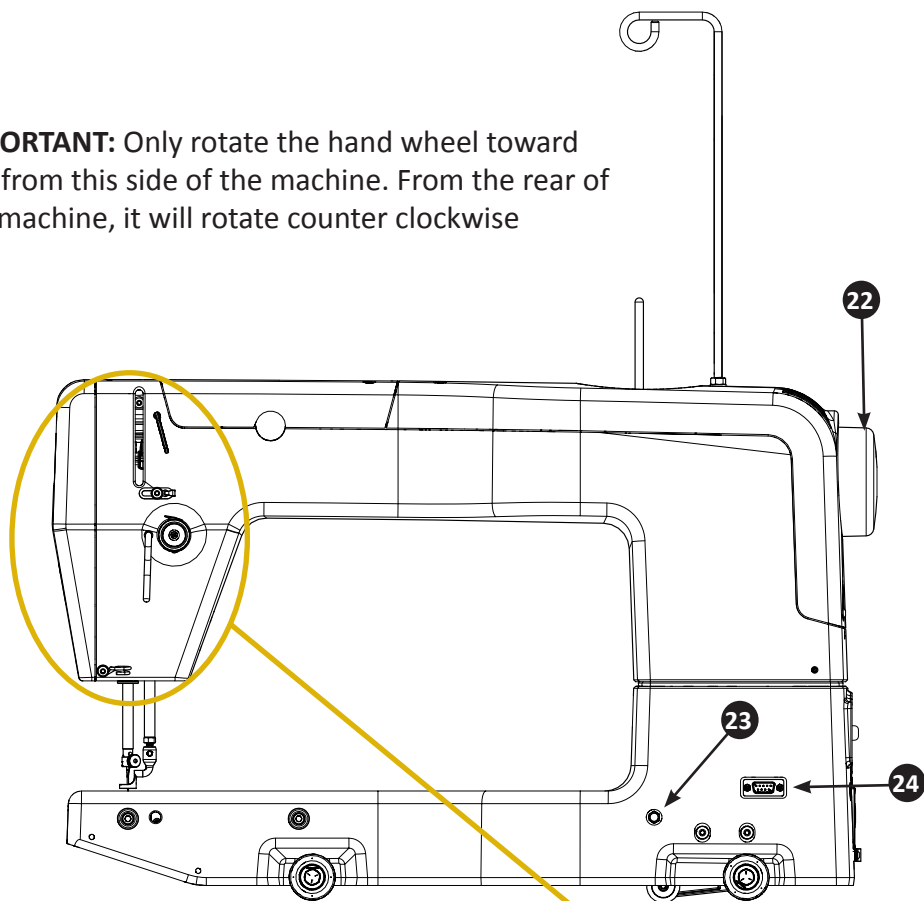

- 22. Hand wheel
- 23. Threaded hole for the optional laser pin
- 24. 9 pin connection plug for the optional laser

Close-up view of tension assembly area

- 25. Three-hole thread guide
- 26. Thread guide
- 27. Take-up spring
- 28. Top tension assembly
- 29. Thread stirrup
- 30. Take-up lever
- 31. Lower thread guide

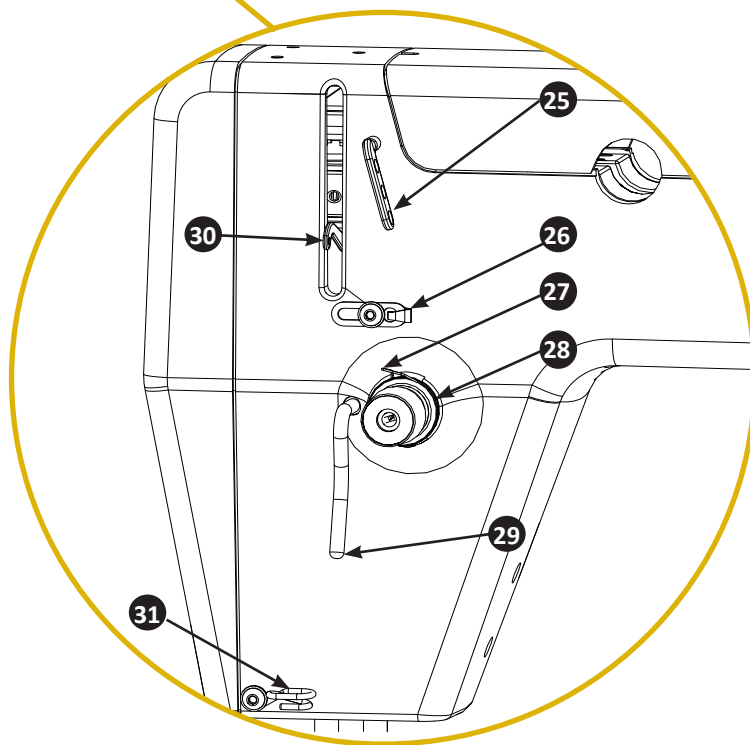

Rear View

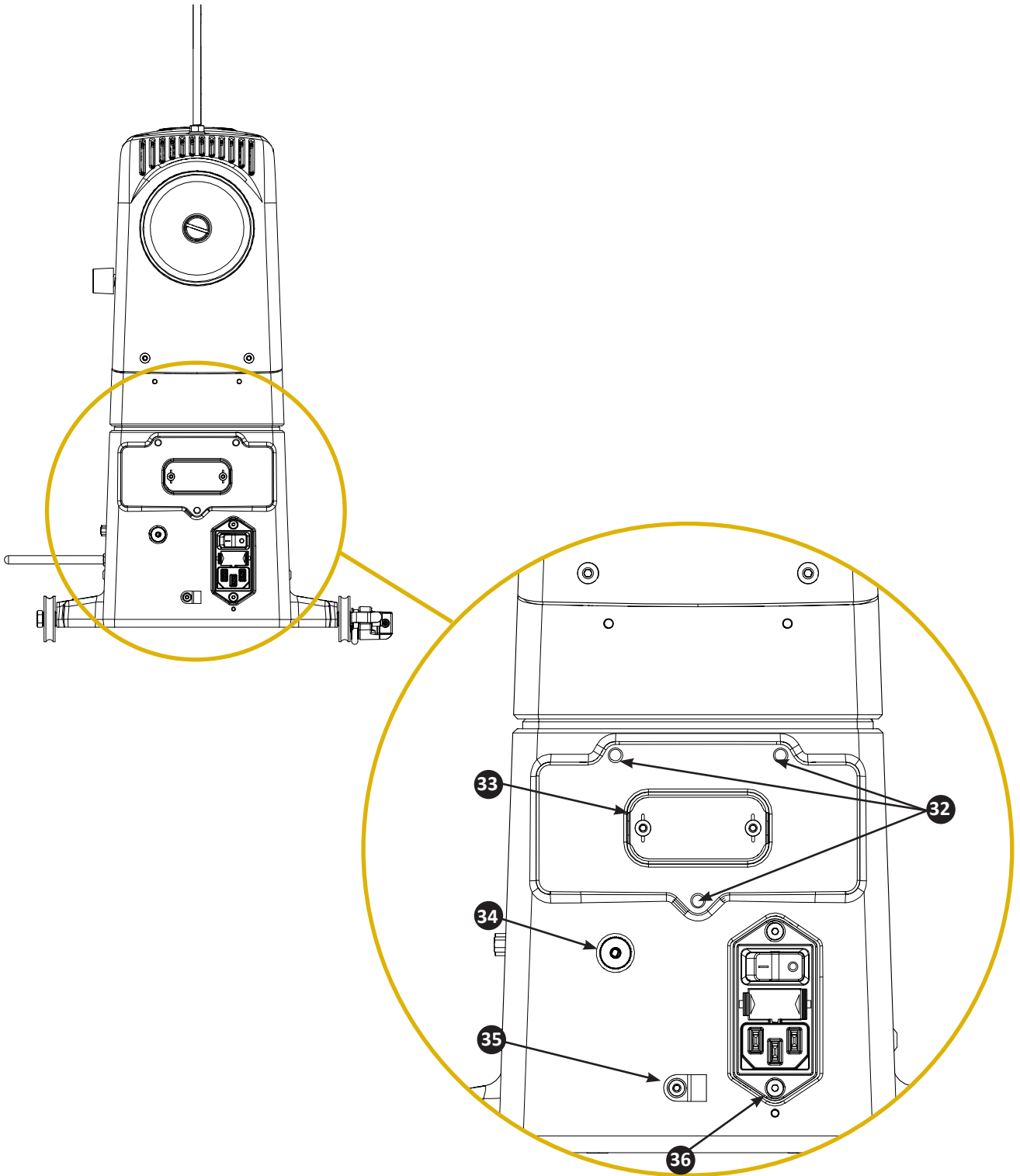

Back View

- 32. Rear handlebar mounting holes (3)
- 33. Rear handlebar connection cover
- 34. Carriage encoder connection jack
- 35. Carriage encoder cable clip
- 36. Power input module with fuse holder

Installation and Setup

Carriage

You should have your frame set up and ready to go. Refer to the frame manual for detailed instructions about setting up the frame.

To install the carriage and machine on the frame (with machine turned off and unplugged)

1. Place the carriage on the tracks, ensuring that the stitch regulator faces the back of the frame.

2. Place the machine on the carriage.

△ **CAUTION:** It is suggested to have two people when lifting the Gallant. Always lift from the throat of the machine, not from the handlebars, needle bar area or needle bar.

3. At the back of the machine, plug the *carriage* encoder cable into the round jack on the back of the machine (to the left of the power cord). Plug the other end into the encoder.

4. Secure the carriage encoder cable through the clip at the back of the machine. Check that there is no strain on the cable at the plug into the machine.

5. Plug the *machine* encoder cable into the round jack on the right side of the machine (as seen from the rear of the machine). Plug the other end into the encoder.

➡ **IMPORTANT:** If you ever need to remove the machine from the carriage, disconnect the carriage encoder cable from the carriage encoder. Failure to unplug the cable when removing the machine from the carriage could result in damage to the cable or carriage encoder.

△ **CAUTION:** Never plug or unplug the encoder cables or any other cables while the quilting machine is on, as this could potentially cause electrical damage to the machine or encoders.

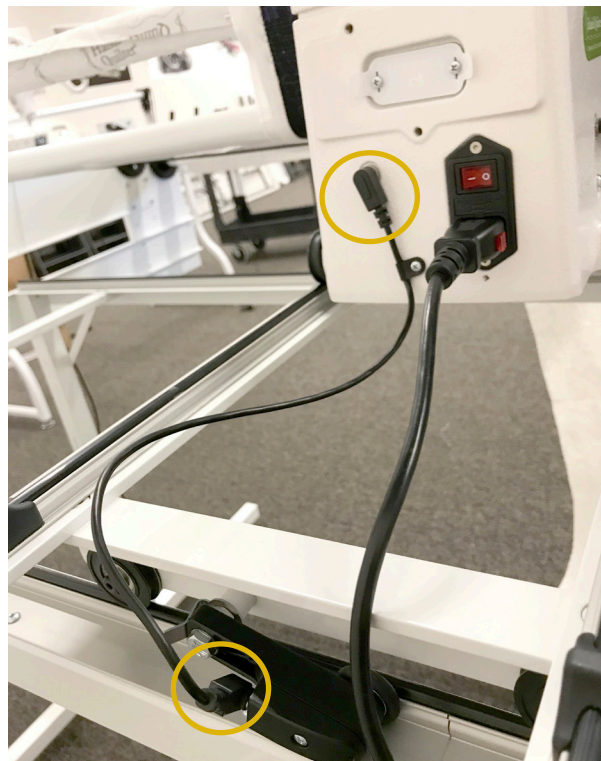

Power Cord

To install the power cord

- Insert the plug into the power connector on the rear of the machine. Plug the three-prong plug end into your power source. **Do not turn on the machine until the handlebars are installed.**

To disconnect the power cord

- First pull out on the red buttons on the sides of the plug and then pull the plug out of the machine.

 **NOTE:** Make sure that the machine is off before plugging into a power source. The main power switch should be in the O (off) position.

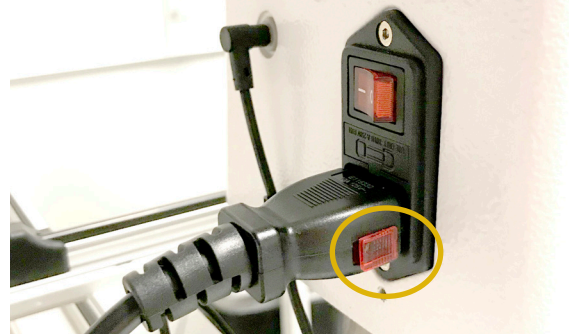

Front Handlebars

The Gallant comes with handlebars for the front of the machine. Optional rear handlebars are available for quilting with pantographs and Groovy or pattern boards. The front handlebars are used for most other quilting activities.

△ **CAUTION:** To prevent any electrical damage to the handlebars, always turn off all power to the machine when connecting or disconnecting the handlebars.

To install the front handlebars

1. Remove the two screws in the front top cover with a 3mm hex tool. Remove cover by pulling up on the rear portion then sliding tabs out in the front.
2. Place four M4x10mm screws with washers down through the handlebar into the top of the machine and tighten them firmly with a 3mm hex tool.
3. Plug the two handlebar cable plugs into the two jacks in the back top (left plug to left jack and right to right). The right handlebar cable is labeled.
4. Push ferrites down into the space so that the cover will fit back into place.
5. Replace the front top cover by sliding tabs at the front into machine and angling the rear of the cover down into place. Tighten the screws with a 3mm hex tool. Do not over tighten.

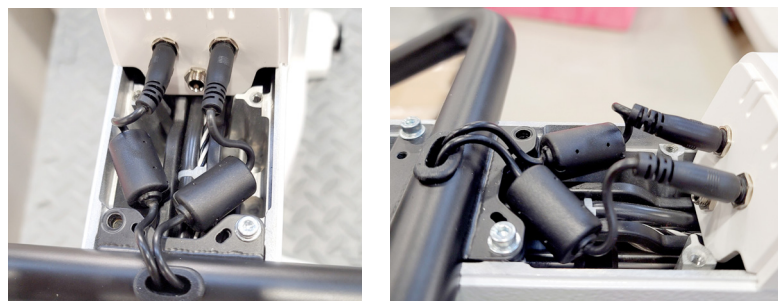
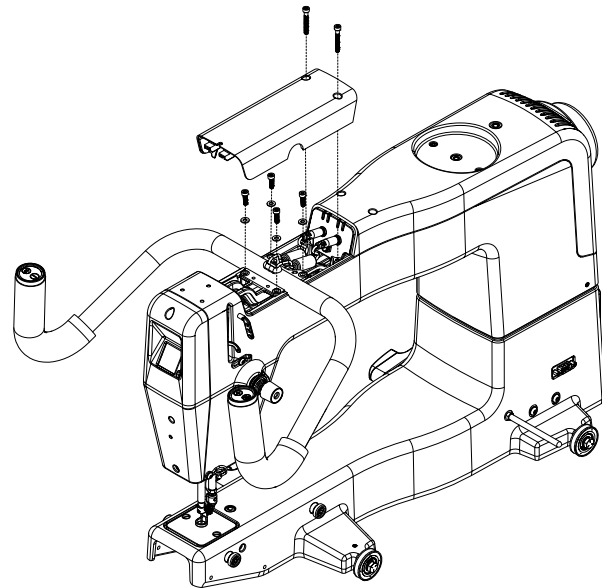

Spool Pin and Thread Mast

To install the spool pin on the machine

1. You'll need the spool pin with nut and washer.
2. Remove the nut and washer.
3. Place the washer against the top of the machine cover.
4. Screw the nut onto the spool pin all the way.
5. Place the spool pin through the washer and into the top cover and tighten it all the way.
6. Hold the spool pin firmly and tighten the nut with the 8mm wrench (provided). Do not over tighten.

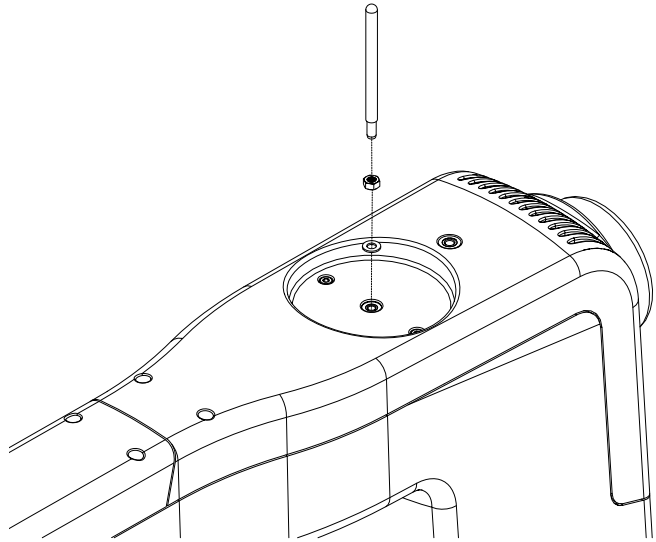

To install the thread mast onto the machine

1. You'll need the thread mast with washer and nut.
2. Remove the nut and washer.
3. Place the washer against the top of the machine cover.
4. Screw the nut onto the thread mast all the way.
5. Place the thread mast through the washer and into the top cover and tighten it down to the nut. Turn until the loop of the mast is directly over the spool pin.
6. Hold the thread mast firmly and tighten the nut with a 10mm wrench (provided). Do not over tighten.

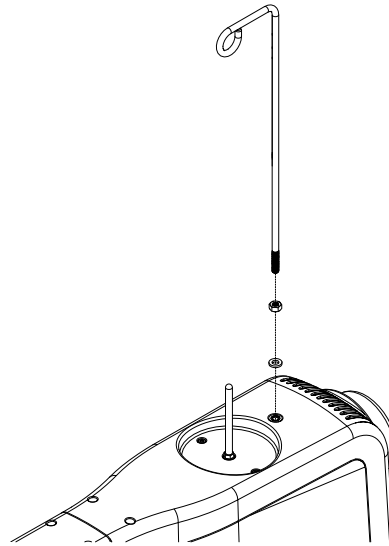

Machine Head USB Port (built-in)

The USB port is a full USB port that can be used to power a USB device, update the machine software, or communicate with accessories. It is located on the side of the machine to the left of the display at the front.

Optional Accessories

Please visit www.babylock.com to view additional optional accessories not featured in this guide.

Rear Handlebars and Laser

To install the rear handlebar

 **NOTE:** Make sure that the machine is off before installing the rear handlebar. The main power switch must be in the O (off) position.

1. Slightly loosen the two Philips screws on the rear handlebar connection cover with a #1 Phillips screwdriver (not provided). Do NOT remove the screws.
2. Pull off the plastic cover. It protects the rear handlebar connection. Do NOT remove the screws.
3. Re-tighten the two screws. They hold the connection board to the machine.
4. You will need three M5 x 12 SKB ZN screws for the rear handlebars and the 3mm hex wrench.
5. Align the three holes in the handlebars with the holes on the back of the machine.
6. Attach with the three screws. Tighten securely.

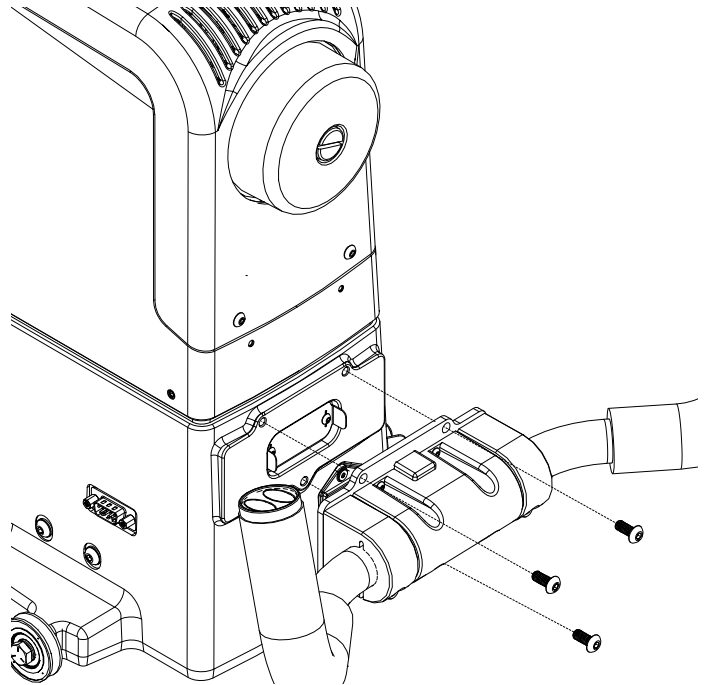

To install the laser pin

1. You will need the laser pin, washer and nut.
2. Screw the nut all the way onto the laser pin.
3. Slide the washer onto the laser pin threads and screw the laser pin all the way into the side of the machine.
4. While holding the laser pin firmly, tighten the nut with the 8mm wrench (provided).

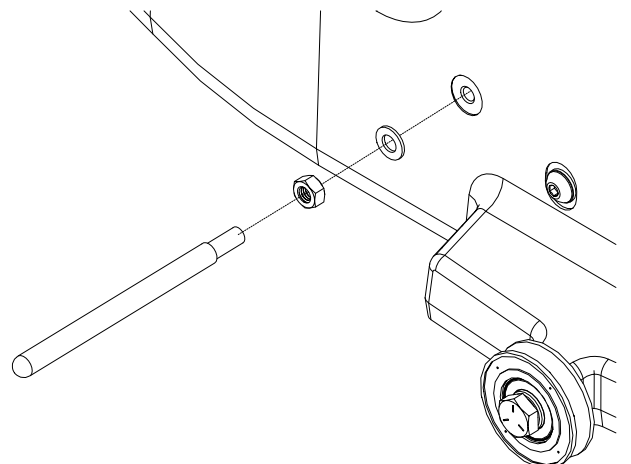

Rear Laser Light

The optional laser light (for use with pantographs) is installed on a mounting post. The post is threaded into a hole on the machine casting. The hole is found towards the back of the machine on the right side about 2 inches in front of the rear wheel; see section on the Laser Pin.

The laser projects a straight laser beam visible as a dot on surfaces it hits. The laser dot is used as a guide enabling you to use printed pantograph designs and stitch the pattern onto a quilt by tracing the design with the laser dot.

The laser attaches to a mounting post which attaches to the machine. The laser stylus can move in any direction by rotating the clamp on the post and pivoting the laser up or down. To make an adjustment, simply loosen the black thumbscrews, position, and re-tighten.

- **IMPORTANT:** A label is attached to the laser's case and shows an arrow which indicates the direction of the laser light when energized. The label must remain in place on the laser. Removing the label voids the laser's warranty.

Laser Safety

When using the laser stylus, observe the following basic safety precautions.

- Never shine directly into the eyes.
- The laser stylus should never be left on and unattended.
- Do not use the laser stylus as a toy.
- Pay close attention when the laser stylus is being used by or near children or pets.
- Use the laser stylus only for its intended use as described in this manual.

- △ **CAUTION:** Use of controls or adjustments or performance of procedures other than those specified herein may result in hazardous radiation exposure.

Laser Operation and Safety

Unplug the laser from the front side of the machine to turn it off. Be sure the laser is attached to the machine and pointed downward toward the table before connecting it to the port. Never point it in a direction that would project the beam into someone's eyes. If the laser should stop working, ensure the plug is firmly seated into the Gallant laser port.



Laser Focus and Image Size

Focus the laser by turning the threaded housing surrounding the lens clockwise or counterclockwise. The laser image can be adjusted to project a bigger or smaller dot, or focal size. The direction of rotation needed is determined by the distance of the laser from the pantograph surface. Experiment by rotating the threaded end to achieve your desired focal size.

 **NOTE:** If you can't see the threaded housing, the lens may be threaded too far into the laser body. You will need to use a large slotted screwdriver to turn it counter clockwise until the housing is visible. You can then rotate it with your fingertips to bring the light into focus. Be very careful to not scratch the lens when using the screwdriver.

Horizontal Spool Pin

The optional Horizontal Spool Pin allows you to use threads that need to feed from the side of the spool horizontally. Examples would be straight-wound spools or mylar holographic threads.

The kit comes with 3 parts; a threaded post, a pin and a clamp. The Gallant does not require the threaded post, so set that aside.

1. Loosen thumbscrew on clamp and attach to the top of the Gallant spool pin through the opening closest to the thumbscrew.
2. Place the pin through the other opening and position it so that it is horizontal, at a 90 degree angle to the Gallant spool pin and pointing out to the right of the machine.
3. Tighten the thumbscrew.
4. Place spool of thread on the horizontal spool pin and thread machine normally.

Gallant Ruler Base

If you plan to use rulers and templates with your Gallant, you will need to attach the ruler base to give you a large, stable surface on which to rest the ruler or template. The ruler base, rulers, and templates are optional accessories.

To install the ruler base

1. The Ruler Base Kit comes with four posts for the ruler base that you will attach to the machine using the 4 screws.
2. Guide the wide part of the latches back until they are between the front and rear ruler base posts. Then lower the ruler base down between the posts.
3. Push the ruler base back until it is touching the machine or snaps into place.



 **NOTE:** When the wide part of the latch is down between the two posts there will still be a gap between the ruler base opening and the front of the machine. Push back on the ruler base to secure it into place

To remove the ruler base

- Grasp the front corners of the ruler base. Pull the ruler base towards you and then up and away from the machine.

To use rulers and templates with your quilting machine

 **CAUTION:** Use only 1/4 inch thick rulers with your machine. Do not use rotary-cutting rulers; they are too thin and can easily slip under the hopping foot. Always use the Gallant Ruler Base to stabilize the ruler. The 1/4-inch Ruler Foot in the Ruler and Echo Foot Set will give an extra measure of security while using rulers.

Keep the ruler flat and quilt only where the ruler is held securely. Avoid losing control by walking your hand along the ruler or stopping and repositioning your hand and/or the ruler.

- Quilting with rulers requires gentle three-point pressure as follows:
 1. Position and press the ruler against any side of the hopping foot.
 2. Press machine against ruler.
 3. Press ruler against ruler base with only as much force as is necessary to keep the ruler from slipping. Too much pressure will prevent the machine from moving.

The quilting line will be approximately 1/4 inch away from the ruler edge. The markings on all Baby Lock rulers take this into consideration.

 **NOTE:** Set the machine to stop in the needle-down position to keep the machine from moving while making adjustments with the ruler.

Using Your Machine

Power Switch

The main power switch is at the rear of the machine.

Turn on the main power switch first by toggling the switch from the **O** position to the **—** position.

- **IMPORTANT:** When you are finished quilting, if you will not be using the machine for more than a day, we recommend you turn off the main power switch and unplug the power cord from the power source.
- **IMPORTANT:** Refer to the safety instructions.

Lighting

The Gallant includes bright LED lights above the needle to make it easy for you to see your quilting. You can adjust the intensity of the lights to suit your environment.

Machine Needle

Use only the recommended needle system for your Gallant quilting machine. The machine is timed to use this specific type of needle (System 134) which is designed to work with the high quilting speeds and multi-directional stitching the Gallant offers.

The Gallant uses the **134 needle system**. Note that the needle has a round shank rather than a shank with a flat side, like home sewing machines use.

If you use the recommended needle, you will experience:

- Fewer skipped stitches
- Less needle breakage
- Less thread breakage, especially at high speeds
- Less thread splicing or shredding
- Optimum fabric protection

- **IMPORTANT:** Change the needle regularly. We recommend you use a new needle for each new quilt and any time the needle becomes bent, dull, or burred.

- △ **CAUTION:** A damaged needle may result in poor stitching quality or may even damage the machine or your quilt.



To change the needle

1. Move the needle bar to the UP position by pressing the Needle Up/Down control on the handlebar.
2. Turn off all power to the machine.
3. Loosen the needle bar clamp screw with the 2.5mm hex wrench.

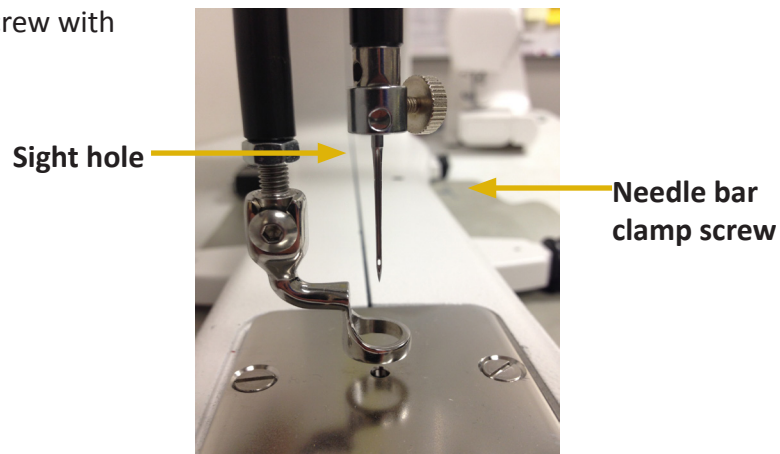

4. Remove the old needle by pulling it down. Discard the old needle in a safe way.

5. With the scarf of the needle (indentation at the back of the needle just above the needle eye) facing the rear of the machine and the long groove down the front of the needle facing the front of the machine, push the needle all the way up into the needle bar until it stops. Check the sight hole to verify that the top of the needle can go up no farther.



- △ **CAUTION:** Check the needle to confirm it is fully inserted. The needle bar has a sight hole above the needle bar clamp screw. Make sure the needle is touching the top of the sight hole. If it isn't all the way up, the machine timing will be off and it may be possible for the needle to collide with internal parts, causing damage not covered by warranty.

6. Carefully tighten the needle bar clamp screw.

- △ **CAUTION:** Although you can use your fingers to tighten the needle bar clamp screw, we recommend that after finger-tightening the screw, you use the 2.5mm hex wrench to tighten it just a bit more. The Gallant runs at very high speeds and this ensures the needle will not loosen while quilting. However, do not over-tighten the needle clamp screw, as this may strip the threads of the screw. (Stripped threads are not covered under the warranty. It may also become difficult to insert the needle properly into the needle bar if threads are stripped.) Once the screw no longer turns freely by hand, gently turn the hex tool until the screw is tightened snugly.

Needle Size	Thread Size
12 and 14	monofilament, 100 wt. silk, 60 wt. polyester, mylar
16	monofilament, mylar, 100 wt., 80 wt., 60 wt., 50 wt., 40 wt. silk, polyester and cotton thread
18	40 wt. cotton and polyester, 30 wt. cotton and polyester
19 and 21	Any thread 30 wt. and heavier such as 12 wt., 19 wt., 30 wt.

- ✂ **QUILTING TIP:** A size 16/100 needle will accommodate most threads and fabrics. Heavier threads, such as top stitch and some decorative threads, require a larger needle such as 18/110 or 21/130. Lofty batting and heavier fabrics such as denim, canvas, or densely woven fabric may also require a larger needle.

Hopping Feet

Your machine comes with two hopping feet: a ruler foot (comes installed) and an open-toe foot. Use the ruler foot for everyday quilting and ruler work, and use the open-toe foot when you need greater stitch visibility (such as when you are micro quilting).

To change the hopping foot

1. Turn off all power to the machine
2. Raise the needle and foot to their highest position. Remove the foot that is on the mount by using the 2.5mm hex wrench to loosen the mounting screw far enough that you can slide the foot off of the mount.
3. Slide the desired foot onto the mount. Note that the opening on the side of the foot is lined up with the screw. Push the foot up as far as it will go.
4. Fully tighten the screw with the 2.5mm hex wrench.

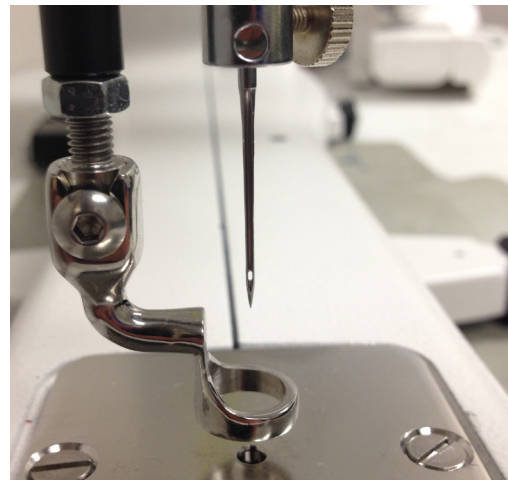

- ⚠ **IMPORTANT:** The Gallant does not have a presser foot lever, or top tension release, like a home sewing machine. On a home sewing machine the top tension is released when the presser foot is raised, allowing the thread to come freely out of the machine. When a home machine is threaded the tension discs are released and open to allow the thread to easily fall between the tension discs. This isn't the case with the Gallant machine. The top tension is always engaged and the tension discs are never open. Therefore the thread must be pulled up, or flossed, between the tension discs or it will stay outside the discs and float without tension, causing serious stitch quality problems and/or thread nests.

Optional Accessory Feet

Baby Lock offers several optional accessory feet that can be used for everyday quilting as well as special techniques. Explore the possibilities at www.babylock.com.

Bobbin and Bobbin Tension

The Gallant quilting machine uses M-class bobbins that are much larger than home sewing machine L-class bobbins. The larger bobbins hold more thread and enable you to quilt for a longer time between bobbin changes.

To wind the bobbin

The Gallant comes with a separate bobbin winder. For full instructions about using the bobbin winder, see the instruction manual that is packaged with the bobbin winder.

To insert the bobbin into the bobbin case

△ **CAUTION:** To prevent personal injury, always turn off the power switch while inserting and/or removing the bobbin case or anytime your hands are near the needle area, such as when you change the needle or the hopping foot.

1. Place the bobbin in the bobbin case so the thread is wound clockwise and coming off top right.

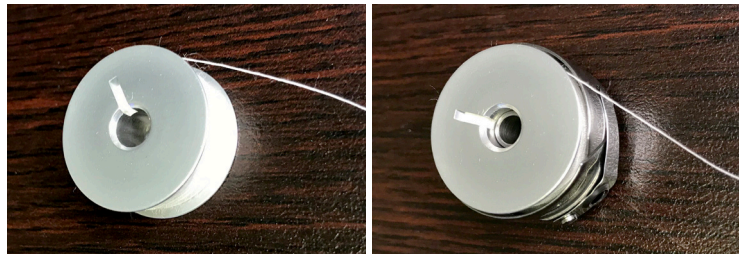

2. The thread will then backtrack through the slot.



3. Guide the thread under the bobbin case tension spring.



4. The bobbin should rotate counterclockwise when the thread is pulled when properly threaded under the tension spring.

 **NOTE:** The rule is for the thread to backtrack as it comes off the bobbin under the tension spring. It should rotate the opposite way it is wound. It should not rotate the same direction it is wound.

To test bobbin tension

The bobbin tension is the foundation for stitch tension. Always set the bobbin tension first.

 **NOTE:** Check the bobbin tension each time a new bobbin is inserted.

1. With the bobbin properly in the bobbin case, hold the bobbin case in the palm of your hand with the open end facing up.
2. Wrap the thread once around the index finger of the opposite hand and attempt to lift the bobbin up by the thread. The bobbin case should stand up on its side, and barely lift out of your hand. If the bobbin will not stand up on its side, the bobbin tension is too loose. If it lifts completely out of your hand and hangs by the thread, the bobbin tension is too tight.

To adjust the bobbin tension

- Make the adjustment using the screw in the center of the tension spring (the larger of the 2 screws). Turn clockwise to tighten and counterclockwise to loosen the tension. Make tiny adjustments to the screw and test again.



To insert the bobbin case into the machine

1. Move the needle to the up position. Turn off the power to the machine.
2. Place the bobbin in the bobbin case.
3. Leave 5 to 6 inches of thread hanging loose. See page 24 for more details.
4. To fit the bobbin case onto the hook spindle in the machine, orient the bobbin case as shown in the photo with alignment tab into the notch to the right. Push the bobbin case inward until it clicks into place.



 **NOTE:** Do not insert the bobbin case into the machine by lifting the release lever on bobbin case. Use the lever only for removing the bobbin case.

Threading the Machine

Baby Lock recommends that you select and use only high-quality threads for your quilts.

To thread the machine

1. Place thread cone onto spool pin **(1)** at top of machine; insert the thread through the thread-mast eyelet **(2)** from back to front, continuing to the three hole thread guide **(3)**.
2. On the three hole thread guide, thread all three holes from back to front, wrapping as you go, being careful not to cross threads. Threading all 3 holes is recommended for most threads. However, some very delicate threads, like metallic or monofilament, may require less tension. If you are having problems with thread breaking, try threading only one or two holes of three-hole thread guide.
3. Continue through the thread guide just above the top tension assembly **(4)**.
4. The thread continues down to the top tension assembly **(5)**.
 - 🔔 **IMPORTANT:** The thread must be flossed up between the two tension discs. If the thread is not firmly in place between the two tension discs, the thread will lay on top of the tension discs (no tension) and thread looping on the bottom of the quilt can occur.
5. After the thread is in place between the tension discs, be sure that the thread catches on the take-up spring **(6)**. Then guide the thread under the stirrup thread guide **(7)**. Bring the thread up and through the hole of the take-up lever **(8)** from back to front, and then through the lower thread guide **(9)**. Thread through the needle bar thread guide hole **(10)** this time from front to back. Almost there!

Make sure the thread follows the groove down the front of the needle and insert the thread through the eye of the needle from front to back **(11)**. While pulling thread through the eye of the needle, be careful that the thread does not twist around the needle.

✍ **NOTE:** Before threading the needle, test that the machine is threaded properly and the tension is correct by carefully pulling the top thread. It should pull smoothly with light to medium tension. If thread pulls freely with no tension, re-thread the machine, ensuring that the thread is flossed all the way between (pulled up into) the tension discs.

1. Spool pin
2. Thread mast eyelet
3. Three hole thread guide
4. Thread guide
5. Top tension assembly
6. Take-up spring
7. Thread stirrup
8. Take-up lever
9. Lower thread guide
10. Needle bar thread guide
11. Needle

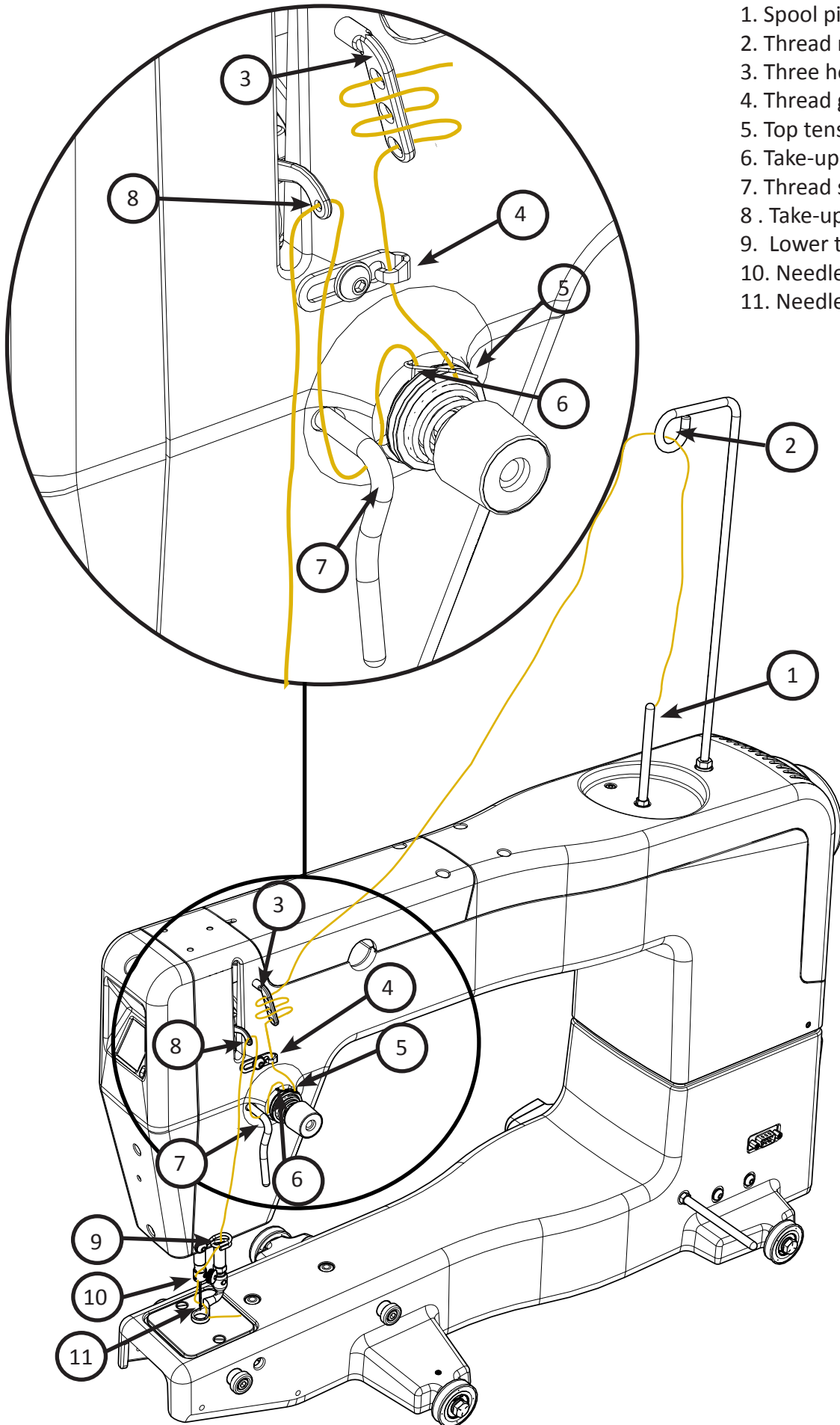

Threading the Needle with the Needle Threader

1. Turn off the power to the machine.
2. Hold the needle threader by the grip, with the triangle mark facing up.
3. Guide the thread, inserting it into the Y groove from right to left horizontally.
4. Place the V groove around the needle, above the eye.
5. Slide the automatic threader down the needle, while pushing it gently against the needle, until the threader pin goes into the needle eye.
6. Push the grip gently. You should see the threader pin and thread loop at the back of the needle.
7. Remove the threader from the needle slowly, then pick up the loop with the hook on the threader, pulling the end of the thread out to the back.
8. Turn machine power back on.

To bring bobbin thread to the top of the quilt

1. After the machine is threaded, move the machine over the quilt to your starting location.
2. While firmly holding the tail of the needle thread, press the needle up/down button twice, causing the needle to go down through the quilt sandwich and then back to the up position.
3. Move the machine two to three inches while holding the needle thread in place. The bobbin thread will pull through to the top of the quilt.
4. Grasp the bobbin thread and pull it to the desired length. Reposition the needle to the starting location. Tie off the threads, using your preferred method, while holding both the top and bobbin thread. To tie off using tiny stitches, press and hold the needle up/down key while slightly moving the machine. Press the Start/Stop key to begin quilting.

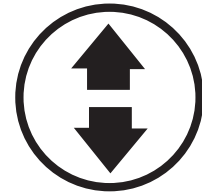

To start or stop quilting



- Start or stop the machine at any time by pressing the Start/Stop key on the handlebars.
- To start quilting press the Start/Stop key. Do not hold the key down.
- To stop quilting press the same Start/Stop key.



Top Tension

One of the joys of quilting with the Gallant is its ability to utilize many different types of thread. You can quilt with almost any high-quality thread as long as you first adjust the bobbin tension and then adjust the top tension to suit the thread you've chosen.

Puckering, gathers, and thread breakage occur when the top thread tension is too tight. Loops and thread nests occur when the top thread tension is too loose. Tension may need to be adjusted depending on the fabric, thread, or batting you are using for your project.

-  **NOTE:** Top tension should be adjusted after the bobbin case tension adjustment is made.
-  **NOTE:** Dark threads will be thicker (because of more dye) than light threads of the same weight and may require a tension adjustment. The type or brand of thread may also affect tension settings. Each time you change threads, you should check your tension.
-  **IMPORTANT:** Before adjusting your top tension remember to floss the top thread UP between the tension discs or it will float outside the discs providing little or no top tension. This could cause significant stitch quality or thread nesting problems.

QUILTING TIP: Test the tension settings before quilting. The best way to make sure the top and bobbin tension settings are balanced is by quilting a test sample. Keep small pieces of light solid fabric on hand to place at the side of the quilt on the extra batting and backing. Then quilt some small loops and swirls and look at the stitches on top and underneath to ensure the tension looks balanced. Fine tune the tension as needed.

To adjust the top tension

1. Test stitching with a scrap of fabric placed on the extra batting and backing at the side of the quilt. Examine the stitches both on the top and on the underside of the quilt.
2. Adjust the tension by turning the tension dial clockwise to tighten and counter-clockwise to loosen.
3. Continue to test the stitching on the fabric scrap and adjust by turning the tension dial until you are happy with the stitches.

Tension Quick Start Guide

1. **Always adjust bobbin tension first.** Bobbin adjustments are minute. Turn the screw in small increments like single minutes on the clock.
2. Stitch to check top tension. To adjust the top tension turn the knob in quarter turns or 15 minute increments.

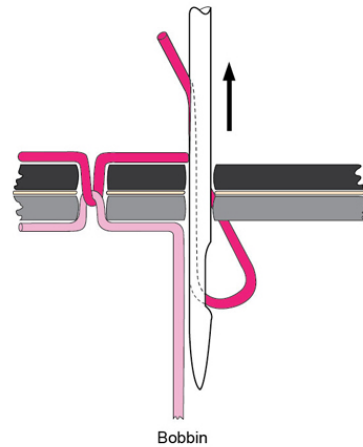

3. If thread looks like Diagram A

Problem: The top thread is too tight.

Solution: Turn the top tension dial counter-clockwise to loosen the top tension.

4. If thread looks like Diagram B

Problem: The top thread is too loose.

Solution: Turn the top tension dial clockwise to tighten the top tension.

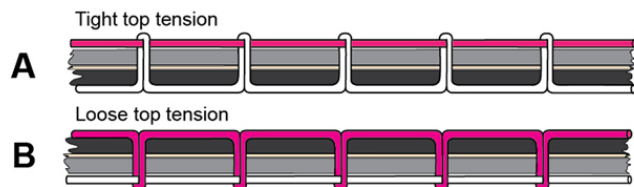

Quilting With the Gallant

Preparing to Quilt

➤ **IMPORTANT:** Make sure your machine has been cleaned, oiled, has a new needle, and that the tracks on the frame are free from threads or other debris. For details on oiling the machine, see page 34.

1. If the machine isn't already plugged in, plug it in now.
2. Select your thread and wind one or more bobbins.
3. Set your bobbin tension and thread your machine.
4. Turn on the main power switch at the back of the machine.
5. After loading your quilt, use a scrap of fabric along the edge of the quilt backing and batting to test your top tension. Make adjustments to the top tension as needed.

To load the quilt on the Villa frame

1. Start with the backing fabric. Find the center of the bottom edge of the backing and match with the center of the backing pole leader. You marked the center of the leader when you installed it with the Velcro. The wrong side of the fabric should be facing up. It is helpful to drape the backing fabric over the take-up pole as you pin the bottom edge to the backing pole leader. Match the raw edge of the fabric with the edge of the leader and pin together. Use long, sturdy quilting pins and insert the pins parallel to the edge of the leader, about 1/4 inch away from the edge. Place pins about 1/2 inch apart. Start pinning at the center and work your way to one side, being careful not to stretch the fabric. Return to the center and work your way to the opposite side. Once the bottom edge is pinned in place, make sure the ratchet stop is engaged and roll the fabric around the pole, smoothing gently as you go. The top edge of the backing fabric gets pinned to the take-up pole leader in the same fashion, matching center of fabric to center of leader. Make sure the leader travels under the idler pole before getting pinned to the top edge of the backing fabric.
2. Next, find the center of the bottom edge of the quilt top. The right side of the quilt top should be facing up. It is helpful to drape the quilt top over the take-up pole as you pin the bottom edge to the top pole leader. Pin the quilt top to the Top pole leader in the same way you pinned the backing. Once the edge is pinned in place, make sure the ratchet stop is engaged and roll the quilt top around the pole, smoothing gently as you go. The top edge of the quilt top will get basted in place to the backing and batting.
3. Consult the diagram to determine the correct pole and the direction of rolling for each of your pieces. If you engage the ratchet stop before rolling, you will always roll in the correct direction.

HIGH POSITION

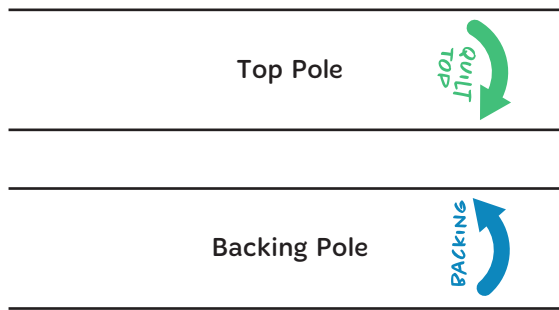
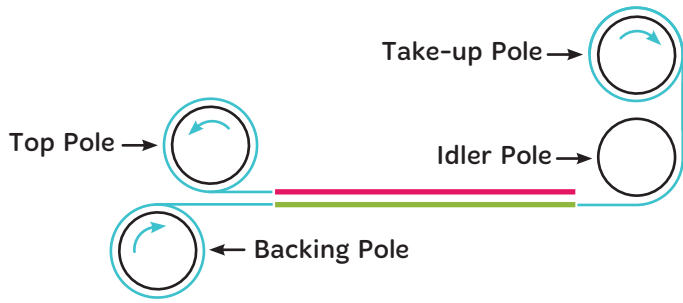

LOW POSITION

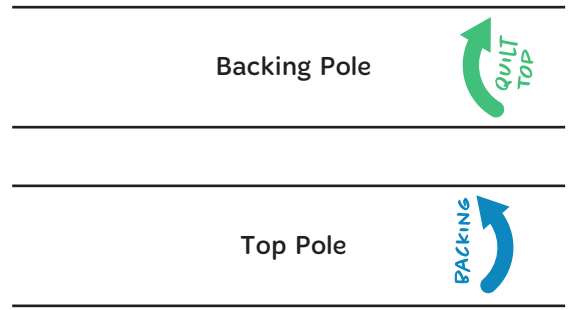
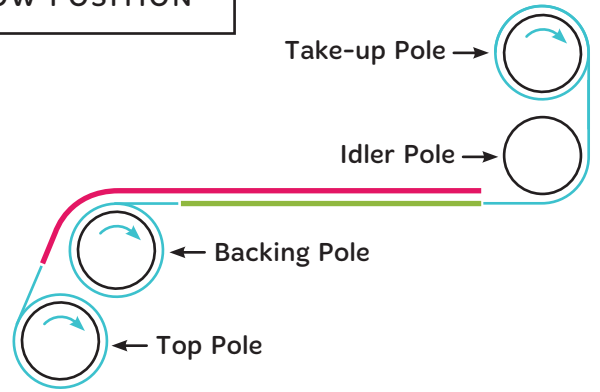

HIGH POSITION LEADERS

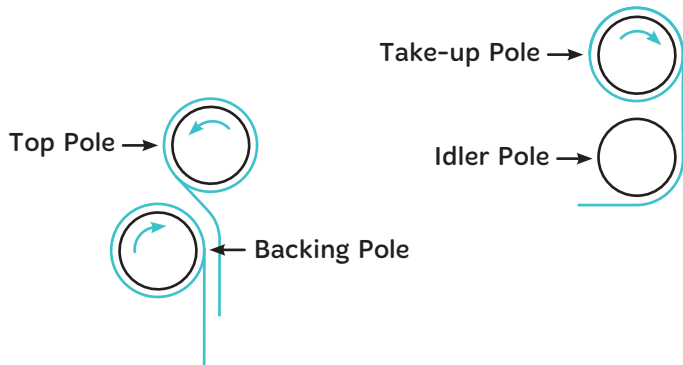

LOW POSITION LEADERS

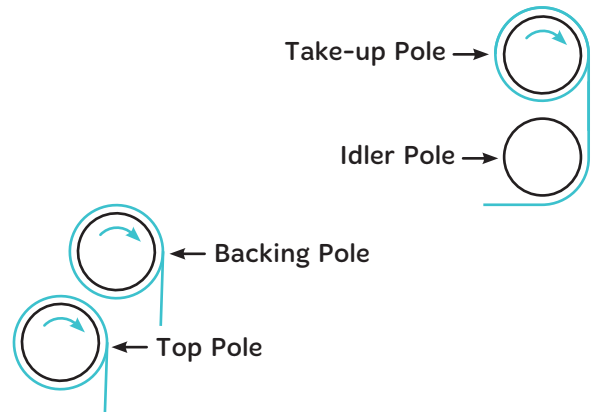

Free-Motion Quilting

- ✦ **QUILTING TIP:** When quilting, relax your hands and maintain a light touch on the handlebars. Gripping the handlebars too tightly means you are trying too hard and you won't quilt smoothly. The Gallant, in combination with the 8-foot Frame system or Coronet Frame system, will give you a smooth even glide while quilting.

Updating the Gallant Software

From time to time Baby Lock may release a software update for your machine. This update feature enables you to take advantage of the latest new capabilities added to your machine. When an update is released, download the updated file(s) to a formatted USB drive using a computer that is connected to the Internet.

- After downloading the updated software to a USB drive, safely remove the USB then insert the drive into the Gallant's USB port.
- From the Menu screen choose Update.



- Choose to update Display OR Machine.
- For more information see page 48 of this manual.

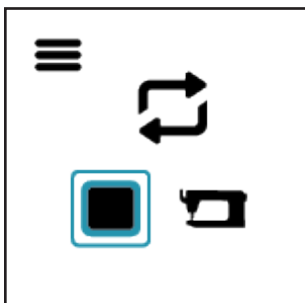

Machine Maintenance

Clean and Oil Your Gallant

The only place where you need to regularly oil your machine is the bobbin hook assembly. Failure to keep the hook assembly lubricated can cause severe damage to the machine. We recommend that you oil the hook assembly with each bobbin change and before use if you haven't used the machine for a few days. A change in the sound of the machine while quilting also indicates that it may need to be oiled.

 **NOTE:** Internal lubrication will be done when the machine is taken to a service technician for routine maintenance and cleaning, every 24 months or 10 million stitches (whichever comes first).

 **IMPORTANT:** Only use light sewing machine oil on the hook when oiling your machine.

To clean the bobbin area and oil the bobbin hook

1. Turn off the machine. Remove the bobbin and bobbin case.
2. Clean the bobbin basket area using a lint brush (provided) or a quick blast of canned air.
3. Put a small drop of oil on the hook in the region where the bobbin basket assembly and the rotating hook meet. The oil will work its way back into the interlocking area of the hook and bobbin basket.
4. Replace the bobbin case with bobbin and turn on the machine.

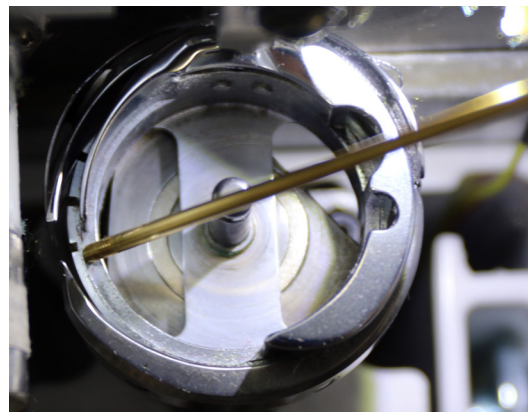

 **QUILTING TIP:** After oiling, always sew a few seconds on a scrap piece of fabric off the side of the quilt as oil may cling to thread. Over-oiling can cause excess dripping from the bobbin assembly.

To clean the Gallant display

- Use a soft rag or microfiber cloth (dampened with diluted isopropyl alcohol if needed) and gently wipe the display to remove any dust or finger marks.

 **CAUTION:** Never use any chemicals to clean your display as this may negatively affect the display's performance.

Maintenance Schedule

In addition to the ongoing cleaning and oiling maintenance that you do on a regular basis when you quilt, you should have your machine serviced by an authorized Baby Lock technician every 24 months or 10 million stitches, whichever occurs first. They will take care of oiling and greasing internal parts and ensure the machine is in optimal working order.

Navigating the Screens

Use the handlebar keys (buttons) to navigate the Home screens, the Menu screen and to choose your settings.

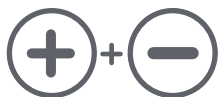

Press together to go to MENU, press a second time, together, to go HOME



Press either to TOGGLE through menus



Press to SELECT



Press to START/STOP



The option or setting selected will be highlighted by a box around the icon

Home Screen



Home Screen - Indicates machine not running (Black)



Home screen - Indicates machine is running (Green)



Box around icon - Indicates the item selected



The Menu Icon - Indicates the screen is a sub-menu



Needle-stop Up - This does not move the needle, but indicates your preference for the final needle position when you stop quilting



Needle-stop Down - This does not move the needle, but indicates your preference for the final needle position when you stop quilting

Home Screen - Variations



Precision Stitch Regulation: Select the Precision icon and then specify the stitches per inch by pressing the Plus or Minus key on the handlebars. Stitch regulation maintains a consistent stitch length (stitches per inch) regardless of how quickly or slowly you move the machine. When quilting in Precision mode, the needle only moves when you move the machine. After you press the Start/Stop key on the handlebar, move the machine to begin quilting according to the stitches-per-inch setting. When you pause moving the machine, the needle will pause until you move again. Press the Start/Stop key on the handlebar to fully stop quilting.



Cruise Stitch Regulation: Select the Cruise icon and then specify the cruise speed (stitches-per-minute) setting using the Plus or Minus key. Press the Needle Up/Down key to go to the Cruise Home screen and use the Plus or Minus keys to set the SPI (stitches per inch). When quilting in Cruise mode, the needle will start to move immediately when you press the Start/Stop key on the handlebar, according to the cruise speed (stitches-per-minute) setting. Once you begin to move the machine, the needle will move according to the stitches-per-inch setting. The needle continues to move at the Cruise speed (stitches per minute) anytime you pause the machine, until you press the Start/Stop key on the handlebar to fully stop quilting.



Manual Stitching Mode: Select the Manual icon and then specify the stitches per minute (speed) by pressing the Plus or Minus key on the handlebars. When using manual stitching mode, the length of the stitch is determined by how quickly or slowly you move the machine around the quilt, in combination with the number of stitches per minute (up to 1800) that you choose. For a consistent stitch length, move the machine at a consistent speed. Experiment with different combinations of quilting speed and stitches per minute to find what optimally works for you.

 **NOTE:** Screens are changed by pressing the handlebar control keys. See page 35.

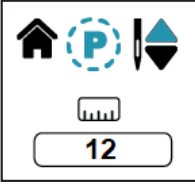

Home Screen with Precision Stitch Mode

- Needle-stop Up, 12 SPI (stitches per inch) selected.
- SPI can be adjusted on this screen when machine is not running using the Plus and Minus keys.

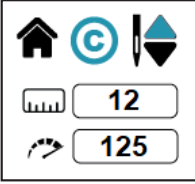

Home Screen with Cruise Stitch Mode

- Needle-stop Up, 12 SPI (stitches per inch)
- Cruise speed set at 125 SPM (stitches per minute) selected.
- SPI can be adjusted on this screen when the machine is not running using the Plus and Minus keys.
- Cruise SPM is adjusted on the Stitch Mode Cruise menu.

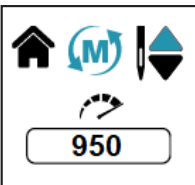

Home Screen with Manual Stitch Mode

- Needle-stop Up, 950 SPM (stitches per minute) selected.
- SPM can be adjusted on this screen when the machine is running or not running using the Plus and Minus keys.

Choose your stitching mode, set the parameters the way you want them and you'll be ready to quilt.

Gallant Screen Layouts

Complete detailed information for navigation and operation can be found on the following pages: 38-49

Menu Screens - Box around icon is the selected item. Press  to go to sub-menu.

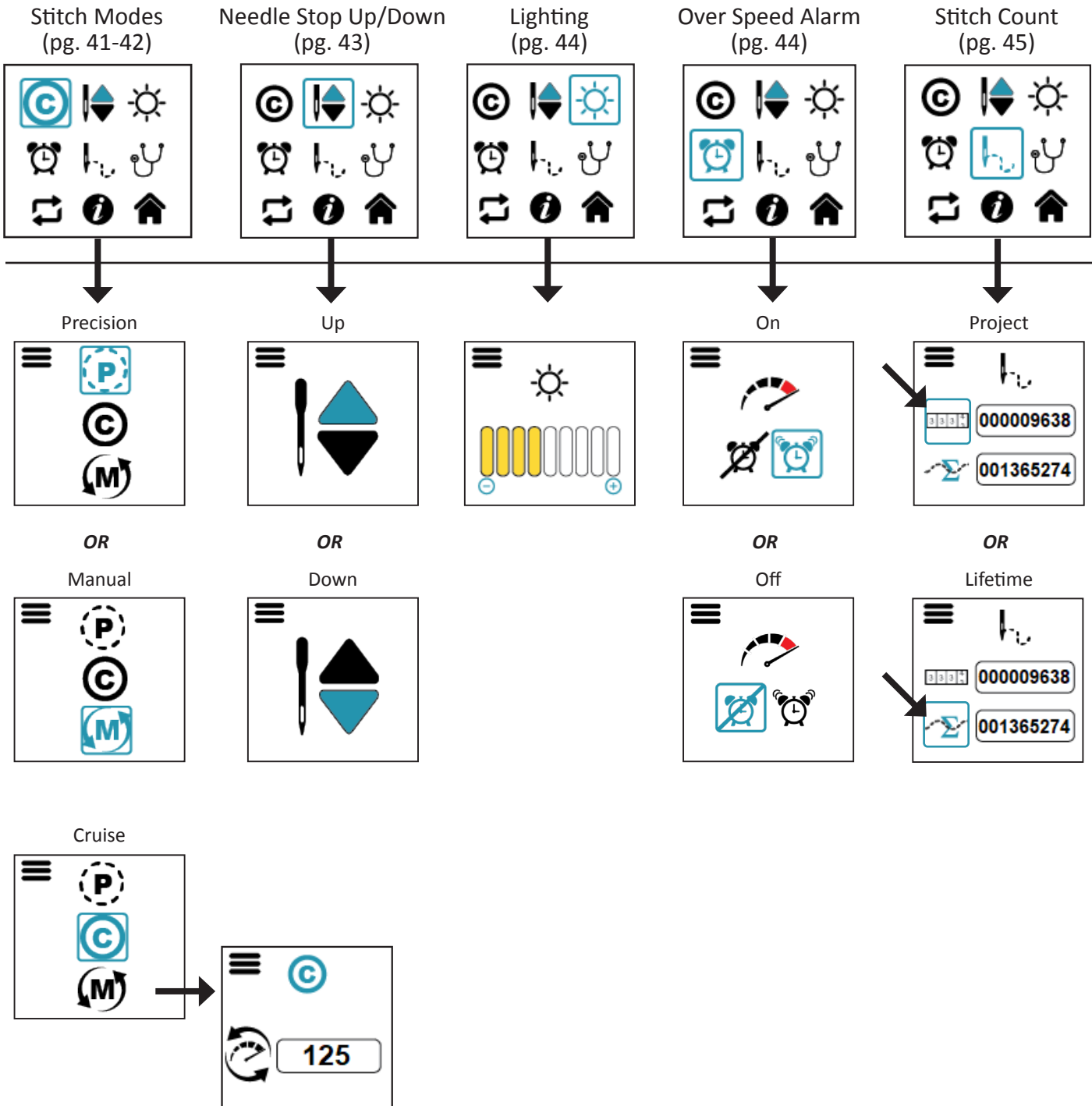

Diagnosis
(pg. 46-47)



Updates
(pg. 48)



Information
(pg. 49)



Home
(pg. 49)



Encoder

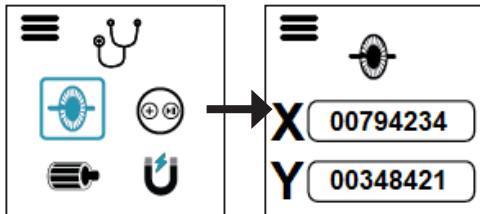

OR

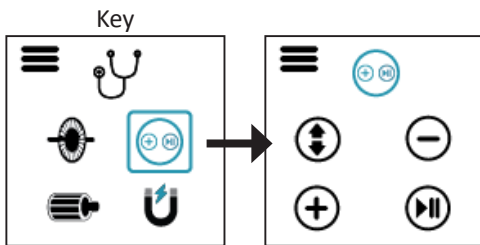

OR

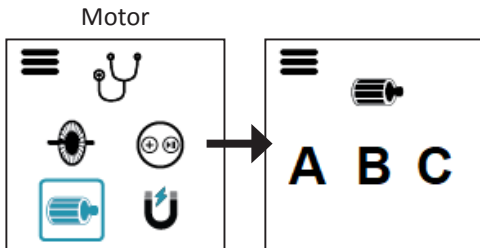

OR

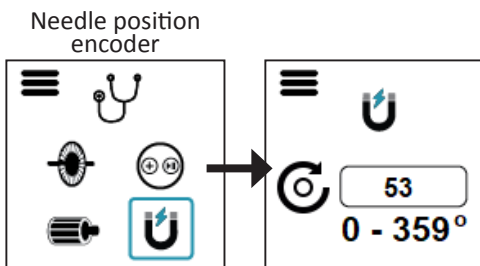

Display

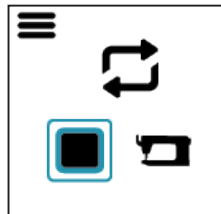

OR

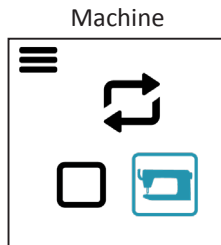

Machine

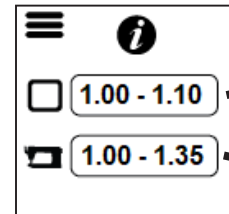

Display hardware/
firmware
Machine hardware/
firmware

Menu



Press the Plus and Minus keys simultaneously to open the Menu screen.

Use the Plus or Minus key individually to move to the desired menu option.

Press the Needle Up/Down key to select or open the desired menu option.

Stitch Modes

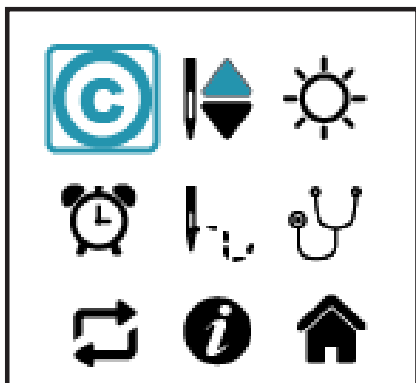

If necessary press the Plus and Minus keys simultaneously to take you to the Menu screen.

Toggle using the Plus or Minus keys to the stitch mode icon in the upper left corner. The icon for the current stitch mode will show there, Precision, Cruise, or Manual.

Select the Stitch Mode icon using the Needle Up/Down key.

Press the Needle Up/Down arrow key to select the desired stitch mode, Precision, Cruise, or Manual.

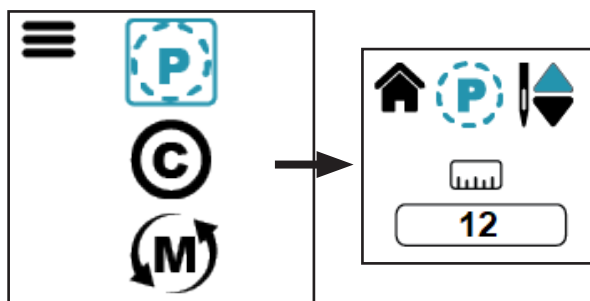

Precision Mode

Select Precision Mode by toggling to the Precision icon and pressing the Select key.

The Precision home screen shows the current stitches per inch setting. The value may be adjusted with the Plus or Minus keys when the machine is stopped. The range is 4 SPI to 18 SPI.

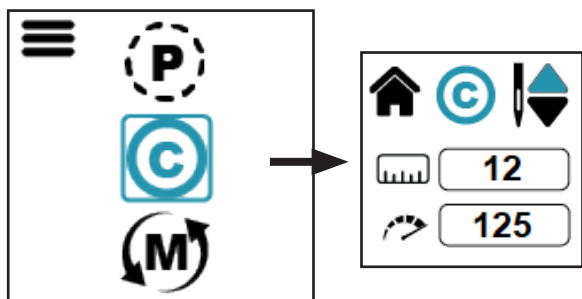

Cruise Mode

Select Cruise Mode by toggling to the Cruise icon and pressing the Select key.

The Cruise home screen shows the current stitches per inch (SPI) and minimum cruise speed. Only the SPI can be adjusted while on this screen, and only while the machine is stopped. See next section for setting the cruise speed.

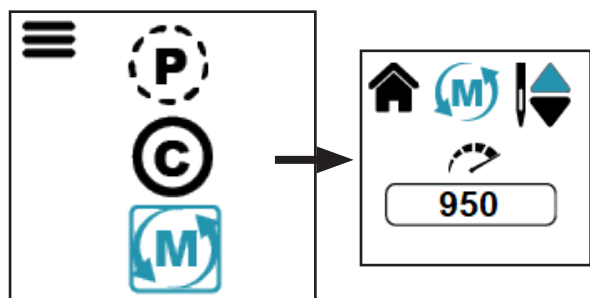

Manual Mode

Select Manual Mode by toggling to the Manual icon and pressing the Select key.

The Manual home screen shows the stitches per minute setting (SPM), which may be changed with the Plus or Minus keys while the machine is running or stopped. The SPM range is 50 to 1800 SPM in increments of 25.

Cruise Stitch Mode - Setting Cruise Speed

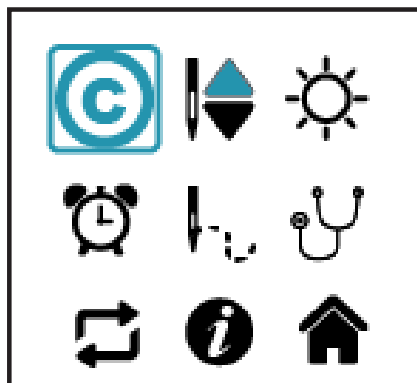

If necessary press the Plus and Minus keys simultaneously to take you to the Menu screen.



Press the Plus or Minus key to toggle to the Cruise Stitch Mode.

Press the Needle Up/Down key to select Cruise stitch mode.



The Cruise Speed menu will open.

The Cruise speed is the minimum SPM (stitches per minute) the machine will stitch regardless of how slowly you move the machine.

Adjust the Cruise speed by pressing the Plus or Minus key.

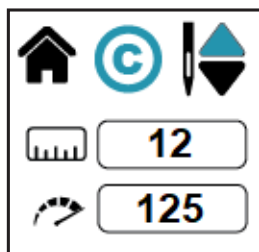

Press the Needle Up/Down key to save the new Cruise speed and to exit the Cruise Speed menu and return to the Cruise Home screen.

 **NOTE:** SPI (stitches per inch) can be changed with the Plus or Minus keys on the Cruise Home screen.

Needle Stop - Up or Down



Set the desired needle position for when you stop quilting.

Most quilters prefer needle stop down.

If necessary press the Plus and Minus keys simultaneously to take you to the Menu screen.

Press the Plus or Minus key to toggle to the Needle Stop option. Press Needle Up/Down to select.

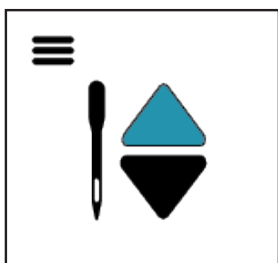

Use the Plus or Minus key to toggle to the desired Needle Stop position.

Needle Up

The needle will cycle to the Up position when you stop quilting.
(Start/Stop key pushed)

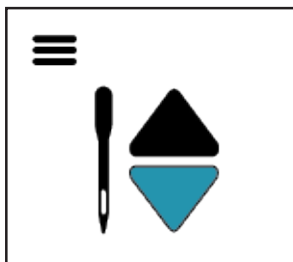

Needle Down

The needle will cycle to the Down position when you stop quilting.
(Start/Stop key pushed)

Press the Needle Up/Down key to select the needle position desired.
This will save the setting and exit to the Menu screen.

Lights

Set the intensity of the lights.



If necessary press the Plus and Minus keys simultaneously to take you to the Menu screen.

Press the Plus or Minus key to toggle to the Lights option. Press the Needle Up/Down key to select.

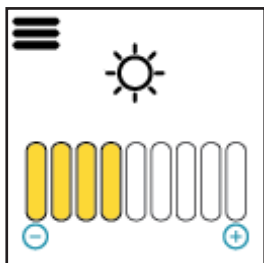

Press the Plus or Minus key to increase or decrease the light intensity as desired.

Press the Needle Up/Down key to save the setting and exit to the Menu screen.

Over-speed Alarm

The over-speed alarm sounds when you are moving the machine faster than the stitch regulation encoders can track.



Turn Over-speed Alarm on or off.

If necessary press the Plus and Minus keys simultaneously to take you to the Menu screen.

Press the Plus or Minus key to toggle to the Alarm option. Press Needle Up/Down to select.

Press the Plus or Minus key to select over-speed alarm on or off.



When the alarm is ON, the alarm will sound letting you know you are moving the machine faster than the stitch regulation encoders can track. This may result in longer than desired stitches. The remedy is to slow down your movement.

When the alarm is OFF, the alarm will not sound regardless of how fast you move the machine.

Press the Needle Up/Down key to save the setting and return to the Menu screen.

Stitch Count

You can know how many stitches went into a quilt by resetting the Project Stitch Count when you start the quilt and viewing the count when you finish. You can also know the Lifetime Stitch Count on your favorite machine, your Gallant!

View the Project Stitch Count and Lifetime Stitch Count and reset the Project Stitch Count.



If necessary press the Plus and Minus keys simultaneously to take you to the Menu screen.

Press the Plus or Minus key to toggle to the Stitch Count option.
Press the Needle Up/Down key to select.

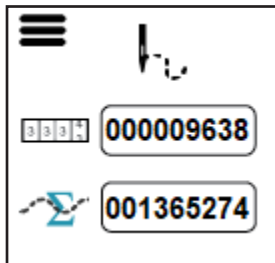

The top count is the **Project Stitch Count**. To reset the Project Stitch Count press Plus or Minus to toggle to it, then press the Needle Up/Down key. The Project Stitch Count will reset to 0.

The bottom count is the **Lifetime Stitch Count**. It cannot be reset. Refer to this count to determine if it is time to have your machine serviced. You should bring your Gallant to a certified Baby Lock technician for routine maintenance, cleaning and internal lubrication, every 24 months or 10 million stitches (whichever comes first).

Press the Needle Up/Down key to return to the Menu screen.

Diagnostics

You may be asked to perform diagnostic tests by Baby Lock's Product Support team or an authorized Baby Lock retailer.



If necessary press the Plus and Minus keys simultaneously to take you to the Menu screen.

Press the Plus or Minus key to toggle to the Diagnostics option. Press the Needle Up/Down key to open the Diagnostics menu.

Use the Plus or Minus key to toggle through the four Diagnostics options. Press the Needle Up/Down key to open the selected Diagnostic test.

 **NOTE:** Exit Diagnostics menu screen by simultaneously pressing Plus and Minus keys.

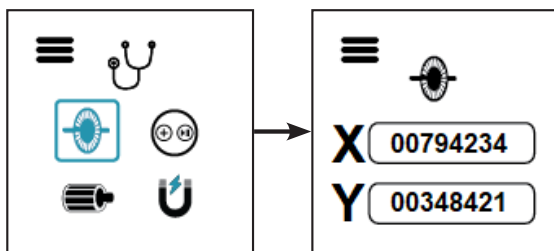

Encoder: This test displays the current X Stitch regulation encoder (left-to-right/right-to-left) and Y Stitch regulation encoder (front-to-back/back-to-front) counts.

Press Needle Up/Down key to open the Encoder Test.

Move the Gallant around the frame.

Pass: Values for X and Y will increase and decrease as the machine and carriage are moved.

Press the Needle Up/Down key to return to the Diagnostics Menu.

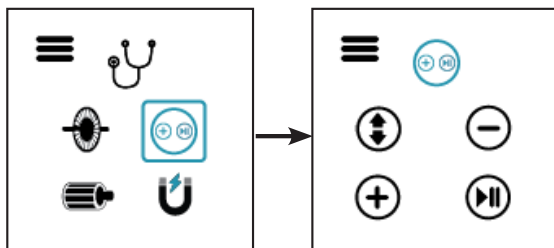

Key: Tests the functionality of the handlebar key switches. Press any of the four keys on the front or back handlebars to verify the Gallant is reading the keys as they are pressed.

Press Needle Up/Down key to open the Key Test.

Press each key on the front or back handlebar several times.

Pass: Each time a key is pressed the corresponding key icon on the diagnostic screen will toggle between selected/unselected.

Press the Plus and Minus keys simultaneously to return to the Menu.

Diagnostics (Continued)

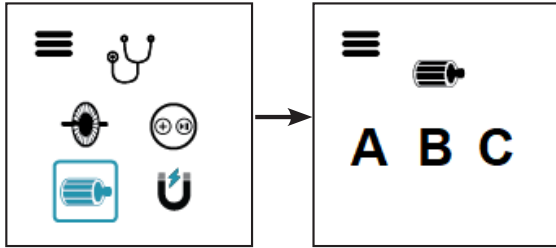

Motor: Tests motor functionality.

Press Needle Up/Down key to open the Motor Test.

While rotating the hand wheel the A B C letters should toggle between selected and unselected indicated by a change of color.

Fail: If A, B, or C does not toggle between selected and unselected as the hand wheel is turned, the motor has failed.

Press the Needle Up/Down key to return to the Diagnostics Menu.

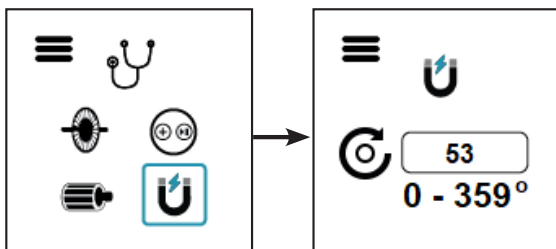

Needle Position Encoder: Tests the needle position.

Press the Needle Up/Down key to open the Needle Position Encoder Test.

While rotating the hand wheel the numbers should cycle from 0 - 359.

Pass: The numbers cycle from 0 - 359 while the hand wheel is rotating.

Press the Needle Up/Down key to return to the Diagnostics Menu.

 **NOTE:** Exit Diagnostics menu screen by simultaneously pressing Plus and Minus keys.

Update



If necessary press the Plus and Minus keys simultaneously to take you to the Menu screen.

Press the Plus or Minus key to toggle to the Update option. Press the Needle Up/Down key to open the Update menu.

This menu allows the display and machine software to be updated through the machine USB port.

Download the update(s) and save to a formatted USB drive.

Insert the USB drive into the USB port on the left side of the nose cover on the Gallant machine.

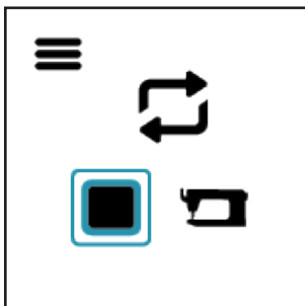

Use the Plus or Minus key to toggle between Display and Machine update. If a machine and display update code is available, install the Display update first.

Press Needle up/Down key to begin the update.

You will hear beeps:

- **3 beeps at 2 second intervals:** indicates there is no USB drive in the port or the USB drive is unreadable.
- **2 beeps at 2 second intervals:** indicates the update file cannot be found or is corrupt.
- **1 beep at 2 second intervals:** indicates the update is in progress.

When the update is complete the machine will beep and return to the Home screen.

Information

The Information screen displays the Machine and Display hardware versions.



If necessary press the Plus and Minus keys simultaneously to take you to the Menu screen.

Press the Plus or Minus key to toggle to the Information option. Press the Needle Up/Down key to open the Information menu.

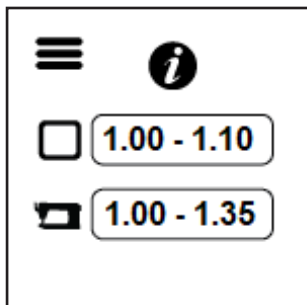

The hardware version, followed by the firmware version is shown.

The Display information is on top,
the Machine information is below.

Press the Needle Up/Down key to return to the Menu.

Home

Returns you to the Home screen.



If necessary press the Plus and Minus keys simultaneously to take you to the Menu screen.

Press the Plus or Minus key to toggle to the Home option.

Press the Needle Up/Down arrow key to go to your Home screen.

Alerts

Alert screens display an icon that indicates an issue with the operation of the machine. It's like the check engine light in your car. Sometimes you can continue to drive home and sometimes you should pull over and call AAA. The Alert might indicate a minor problem you can remedy on your own, like a loose cable. Other times you may need to seek help from your local retailer or Baby Lock's Product Support team.

An icon will be displayed on the screen along with a code number that appears in the upper right hand corner of the screen. This number will help a certified technician or Baby Lock's Product Support team diagnose the issue. The number will not mean anything to you, but make note of it so you can relay it to your technician.

The icons that can be displayed are shown below.



Over/under voltage: This icon appears when the machine has detected a voltage that is out of range for an extended period of time.

Power cycle the machine by turning the machine off at the power switch, wait 10 seconds and then turn back on. If the trouble repeats, please contact your retailer for service.



Over-current: This icon may appear when the machine has hit an obstruction or is unable to sew through the fabric.

Check your quilt for any obstruction, such as a pin, and remove it. Check that the hand wheel can rotate freely then clear the screen by pressing any key.

If the trouble repeats, please contact your retailer.



Obstruction: This icon indicates there may be thread or lint trapped in the bobbin race.

Check for thread or lint in the bobbin race. You may need to have someone turn the hand wheel while you watch the bobbin race. Remove the obstruction and oil the hook. Check that the hand wheel can rotate freely.

Clear the screen by pressing any key.

Alerts (Continued)



Motor Hall Sensor: This icon indicates the hall sensors did not change state correctly.

In the unlikely situation where the control system has detected an incorrect motor sensor sequence, please contact your retailer for repairs.

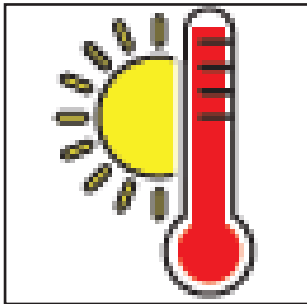

Over-temperature: The over-temperature icon appears if:

- the machine is being stressed by an obstruction
- the machine is stitching through extremely difficult fabric to sew, or
- the machine is operating in a hot environment.

Power off the machine and allow it to cool down. If the problem persists, contact your retailer.



Magnetic Encoder: This icon indicates a problem with the main shaft position sensor.

Please contact your retailer for service.

Alerts (Continued)



Service: This icon indicates that the machine should be serviced.

Please contact your retailer for service

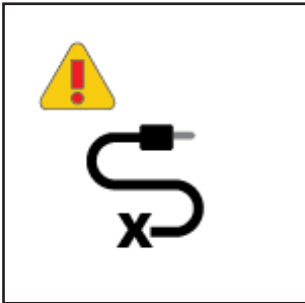

X Encoder: This icon shows the X encoder is not fully plugged in.

Turn off the machine then unplug and replug the connector at both the encoder end and the machine end to ensure it is completely plugged in. Also check the X encoder (the one at the back of the carriage) and the cable for damage.

Clear the screen by pressing any key.

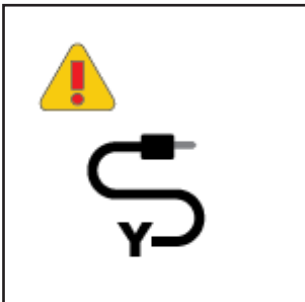

Y Encoder: This icon shows the Y encoder is not fully plugged in.

Turn off the machine then unplug and replug the connector at both the encoder end and the machine end to ensure it is completely plugged in. Also check the Y encoder (the one at the side of the machine) and the cable for damage.

Clear the screen by pressing any key.

Troubleshooting

You can correct many problems on your own. If you need additional help, contact your local, authorized Baby Lock retailer who supports you and your machine. You can also contact Baby Lock Product Support at 800-313-4110 or www.babylock.com/support/contact.

First check the following:

1. The AC power cord is properly connected (at both ends) and the power switch is turned on.
2. Confirm that all cables are properly seated into their connections.
3. Turn off the machine completely. Wait for at least ten seconds and then turn it back on.

If the above checks do not solve the problem, refer to the information below.

Skipped Stitches	Corrective Measure(s)
The needle is damaged, dull, bent, or installed improperly	<ul style="list-style-type: none"> • Replace the needle often, normally once or twice per day for continuous quilting or at least once per quilt. Use only the recommended needle system. • Always change the needle if the needle has struck any hard object such as a pin. The tip of the needle can become damaged or burred, resulting in fabric damage, as well as skipped stitches, thread breakage, or shredding. • Always change the needle if it has been hit, bumped or pulled off center while maneuvering the machine over the quilt. A slightly bent needle can be a major cause of skipped stitches.
Incorrect needle size	<ul style="list-style-type: none"> • Use the proper size needle for the job. Start with matching the needle size with the thread; consult the chart on your Gallant Quick Reference Card. Some battings and fabrics used in quilting may require a larger size needle. • You will need to experiment to determine which works best with your combination of fabric, thread, and batting.
Fabric is too tight on the frame	<ul style="list-style-type: none"> • Loosen the fabric tension on the frame. Fabric that is tensioned too tightly causes the fabric to bounce while quilting. This can result in skipped stitches.
Thread tension too tight	<ul style="list-style-type: none"> • Check bobbin case tension and then check top thread tension. For more information about adjusting tension, see <i>Bobbin and Bobbin Tension</i> in the <i>Using Your Machine</i> section of this manual.
Improper threading	<ul style="list-style-type: none"> • Ensure that the machine is threaded correctly. Refer to your Gallant Quick Reference Card if needed.

The needle is not positioned properly	<ul style="list-style-type: none"> • Position the needle properly to the needle bar. Inspect the position of the needle to make sure the needle is at the 6 o'clock position. When you stand directly in front of the needle, facing the front (bobbin case side) of the machine, you will see the entire needle eye directly facing you. This is the 6 o'clock position. • Make sure (a) the needle is installed all the way into the needle bar, and (b) the long groove in the needle is toward the front, and (c) the scarf, the scooped out part of the back of the needle, is toward the back of the machine.
Needle Breaks	Corrective Measure(s)
The needle is bent or not installed properly	<ul style="list-style-type: none"> • Replace the needle. Make sure that the needle is pushed into the needle bar clamp until it can go no further. Visually check that it is up to the top of the sight hole above the needle bar clamp screw. If the needle isn't installed properly, it can cause damage in the bobbin area and throat plate.
The needle hits the throat plate	<ul style="list-style-type: none"> • Correctly position the needle, throat plate, or hopping foot. Replace with a new needle.
Stitches Are Puckered	Corrective Measure(s)
The tension is not balanced	<ul style="list-style-type: none"> • Balance the tension of the top thread after ensuring the bobbin tension is adjusted correctly. For more information about adjusting tension, see <i>Bobbin and Bobbin Tension</i> in the <i>Using Your Machine</i> section of this manual.
Needle too large for quilting thread	<ul style="list-style-type: none"> • Replace the needle with a size better suited for the thread.
Poor Stitch Quality	Corrective Measure(s)
The tension is not balanced	<ul style="list-style-type: none"> • Balance the tension of the top thread after ensuring the bobbin tension is adjusted correctly. For more information about adjusting tension, see <i>Bobbin and Bobbin Tension</i> in the <i>Using Your Machine</i> section of this manual.
Bobbin case is damaged, corroded, dirty, etc.	<ul style="list-style-type: none"> • Since thread slides over the surface of the bobbin case at a high speed, make sure the case is free of any lint or foreign matter that could impede thread passage through the machine.
Moving the machine too fast for needle speed selected (Manual mode)	<ul style="list-style-type: none"> • Synchronize machine movement and needle speed to get your desired stitch length. Elongated stitches are an indication of moving the machine too fast for the current speed.

Tension Is Poor	Corrective Measure(s)
Lint caught under the tension spring on the bobbin case	<ul style="list-style-type: none"> If using short staple threads, inexpensive threads, industrial threads, or coated threads, lint and other material will build up under the tension spring and begin to lift the spring. This reduces the spring's ability to compress against the thread. Insert the corner of a business card under the spring and clear out the lint. The bobbin tension will return fairly close to its preset tension. Test the tension before quilting.
Hand Wheel Won't Rotate	Corrective Measure(s)
Thread is entangled and caught in the hook	<ul style="list-style-type: none"> There may be a thread lock. Quickly rock the hand wheel, at the back of the machine, back and forth several times. You may need another person to turn the hand wheel while you look for the thread that is caught. Once thread lock is cleared re-oil the hook and make sure the hand wheel turns freely.
There is a thread lock.	<ul style="list-style-type: none"> Carefully rock the hand wheel in direction of motion and then the other direction until the thread lock breaks free. Once the hand wheel can be turned freely, remove the thread from the hook and basket. Now re-oil the hook and make sure the hand wheel turns freely without the hook hitting the needle. It is possible for a thread lock to cause a timing problem.
Thread Nests under Quilt	Corrective Measure(s)
Not enough tension on top thread	<ul style="list-style-type: none"> Check that the machine is threaded correctly. Make certain that the thread is flossed snugly in place between the two tension discs. If the machine is threaded correctly, tighten top tension by rotating the tension knob clockwise. (For more information about adjusting tension, see <i>Bobbin and Bobbin Tension</i> in the <i>Using Your Machine</i> section of this manual.)
Improper threading	<ul style="list-style-type: none"> Refer to threading diagram and threading instructions.
Thread Backlash	Corrective Measure(s)
Bobbin thread tangles within the bobbin case, tangles and winds onto the hook spindle, or occasionally forms loops on the bottom of the quilt	<ul style="list-style-type: none"> Make sure the bobbin is in the bobbin case correctly and the thread is coming out from under the tension spring. The bobbin should rotate clockwise when the thread is pulled.
Hard to Guide Machine	Corrective Measure(s)
Carriage wheels not centered on track	<ul style="list-style-type: none"> Center the carriage wheels on top of the continuous track. Refer to your frame instructions. Check that the machine carriage has not jumped the track.

Thread caught in wheels	<ul style="list-style-type: none"> • Remove all thread or debris from the wheels. • Check that the tracks are free of lint and threads.
Motor Fails to Run	Corrective Measure(s)
On/Off switch turned off	<ul style="list-style-type: none"> • Make sure that the power switch is in the on position.
Machine not receiving power	<ul style="list-style-type: none"> • Check that the power connector is securely plugged into the back of the machine and the three-prong end is plugged into the power source. Unplug and re-plug.
Uneven Quilt Design	Corrective Measure(s)
Take-up rollers may be bowed or bent	<ul style="list-style-type: none"> • Make certain the fabric is not rolled too tight, causing the poles to bow. Check that poles are inserted completely together with the push buttons engaged so bowing won't occur.
Leaders are stretched or worn	<ul style="list-style-type: none"> • If fabric is beginning to stretch or fray, contact Baby Lock to purchase replacement leaders.
Thread Breaks	Corrective Measure(s)
Poor quality thread, may have severe twisting or thread rot	<ul style="list-style-type: none"> • Look for severe twisting of threads when approximately 12 to 15 inches has been pulled off, with the ends pinched together. • Cotton threads are particularly susceptible to dry rot or wet rot which makes thread brittle. • Do not use poor quality thread, or thread that is rotted or brittle.
Top and bobbin tensions not balanced	<ul style="list-style-type: none"> • Balance the tension of the needle thread after ensuring the bobbin tension is adjusted correctly. (For more information about adjusting tension, see <i>Bobbin and Bobbin Tension</i> in the <i>Using Your Machine</i> section of this manual.)
The machine has been threaded incorrectly or thread spools are not positioned correctly	<ul style="list-style-type: none"> • Check that the machine is threaded correctly. Refer to diagram on Quick Reference Card. • Check for accidental double wrapping of thread on thread guides. • Check the thread mast, making sure the eyelet of the mast is directly over the cone. • Check the position of the thread cone. Tipped cones can dramatically affect thread tension and can cause breakage.
Debris in tension discs	<ul style="list-style-type: none"> • Inspect for particles and remove any fuzz or debris.
Bobbin rotation is not smooth	<ul style="list-style-type: none"> • Change the bobbin. The slightest hesitation of the bobbin rotation can be the cause of dramatic tension change and thread breakage.

Needle is burred, bent or dull, or installed incorrectly	<ul style="list-style-type: none"> • Change the needle at least once per quilt. Make sure the needle is installed to the top of the sight hole in the needle bar.
Needle not suitable for thread	<ul style="list-style-type: none"> • Replace the needle to one better suited for the thread. Use the proper size needle. Refer to chart in Machine Needle section.
Hesitating too long at one point in quilting motif	<ul style="list-style-type: none"> • Move more quickly so stitches don't overlap or build up. When starting the machine, begin moving immediately. Sewing in one place too long will cause the thread to break.
Improper needle/hook relationship	<ul style="list-style-type: none"> • Machine timing needs to be checked. Consult an authorized Baby Lock technician.
Damage or burr at needle hole of throat plate or other thread handling part	<ul style="list-style-type: none"> • If thread is shredding at the throat plate, check for burrs or jagged edges. Gently rub with emery cloth to remove the sharp edge. Consult a repair technician to polish any hard-to-reach or delicate areas.
Wrong type of needle	<ul style="list-style-type: none"> • Use only the needles recommended by Baby Lock (needle system 134, sizes 12 through 21).
Other possible problems	<ul style="list-style-type: none"> • Needle too close to hook, causing friction and possible collision of hook point and needle (causing broken thread). • Needle plate damage • Hook damage • Broken needles or damaged needle bar clamp

 **NOTE:** If the troubleshooting tips do not eliminate the problem, please consult an authorized Baby Lock retailer.

Appendix 1

Federal Communications Commissions (FCC) Declaration of Conformity (For USA Only)

Responsible Party: Tacony Corporation
Corporate Center
1760 Gilsinn Lane
Fenton, MO 63026-0730 USA

declares that the product,
Product Name: Gallant

complies with Part 15 of the FCC Rules. Operation is subject to the following two conditions: (1) this device may not cause harmful interference, and (2) this device must accept any interference received, including interference that may cause undesired operation.

This equipment has been tested and found to comply with the limits for Class B digital device, pursuant to Part 15 of the FCC Rules. These limits are designed to provide reasonable protection against harmful interference in a residential installation. This equipment generates, uses, and can radiate radio frequency energy and, if not installed and used in accordance with the instructions, may cause harmful interference to radio communications. However, there is no guarantee that interference will not occur in a particular installation.

If this equipment does cause harmful interference to radio or television reception, which can be determined by turning the equipment off and on, the user is encouraged to try to correct the interference by one or more of the following measures:

- Reorient or relocate the receiving antenna.
- Increase the separation between the equipment and receiver.
- Consult the dealer or an experienced radio/TV technician for help.

Changes or modifications not expressly approved by the manufacturer or local sales distributor could void the user's authority to operate the equipment.

Canadian Department of Communications Compliance Statement (For Canada Only)

This digital apparatus does not exceed the Class B limits for radio noise emission from digital apparatus as set out in the interference-causing equipment standard entitled "Digital Apparatus", ICES-003 of the Department of Communications.

Radio Interference (Other than USA and Canada)

This machine complies with EN55022 (CISPR Publication 22) /Class B and AUS/NZ 55022/Class B.