



BERNINA 700

made to create **BERNINA**

Edition notice

Graphics

www.sculpt.ch

Text, Setting and Layout

BERNINA International AG

Fotos

Patrice Heilmann, Winterthur

Order number

2016/05 en 0371485.0.04

1st Edition

Copyright

2016 BERNINA International AG

All rights reserved: For technical reasons and for the purpose of product improvements, changes concerning the features of the machine can be made at any time and without advance notice. The supplied accessory can vary depending on the country of delivery.

Contents

IMPORTANT SAFETY INSTRUCTIONS	10
1 My BERNINA	13
1.1 Introduction	13
1.2 Welcome to the world of BERNINA	13
1.3 Key to signs	14
1.4 Overview Machine	15
Overview front controls	15
Overview front	16
Overview sideways	17
Overview back	18
Overview Embroidery module	19
1.5 Supplied accessories	19
Overview accessories machine	19
Use of the power cable (only USA/Canada)	21
Foot control (only USA/Canada) (Optional accessory)	21
Accessory box	21
Overview Accessory Embroidery module	23
1.6 Overview User Interface	24
Overview Functions and Views	24
Overview System settings	24
Overview Selection menu	24
Overview Icons	25
1.7 Needle, Thread, Fabric	26
Overview needles	26
Example of needle description	27
Needle/thread combination	27
Upper thread	27
Bobbin thread	28
1.8 Important Embroidery information	28
Choosing the embroidery motif	28
Embroidery test	28
The size of the embroidery motif	29
Embroidering motifs by third-party providers	29
Underlay stitches	29
Satin stitch	29
Step stitch	30
Connecting stitches	30
2 Embroidery preparation	31
2.1 Accessory box	31
Accessory box free standing	31
Storing accessory	31
2.2 Connection and Switching on	32
Connecting the foot control (Optional accessory)	32
Connecting the machine	32
Fixing the touchscreen pen	33

	Switching on the machine.....	33
	Switching on the sewing light.....	33
2.3	Foot control (Optional accessory).....	33
	Regulating the speed via the foot control.....	33
	Raising/Lowering the needle.....	34
2.4	Spool pin.....	34
	Swiveling spool pin.....	34
	Horizontal spool pin.....	35
	Attaching the multiple-spool holder.....	36
2.5	Free arm.....	36
2.6	Embroidery foot.....	36
	Adjusting the presser foot position via the button «Presser foot up/down».....	36
	Attaching the embroidery foot.....	36
	Selecting the embroidery foot in the User Interface.....	37
2.7	Needle and stitch plate.....	37
	Inserting the embroidery needle.....	37
	Selecting the needle in the User Interface.....	38
	Selecting needle type and needle size.....	38
	Attaching the stitch plate.....	38
	Selecting the stitch plate in the User Interface.....	39
2.8	Threading.....	39
	Threading the upper thread.....	39
	Winding the bobbin thread.....	42
	Threading the bobbin thread.....	43
	Thread-up command.....	46
	Indicating fill level of bobbin thread.....	46
2.9	Attaching the Module.....	46
2.10	Selecting the embroidery motif.....	47
2.11	Embroidery hoop.....	47
	Overview embroidery hoop selection.....	47
	Selecting the embroidery hoop.....	48
	Tear-away stabilizers.....	48
	Cut-away stabilizers.....	48
	Using adhesive spray.....	48
	Using spray starch.....	48
	Using iron-on interfacing.....	48
	Using paper-backed adhesive stabilizer.....	49
	Using water-soluble stabilizer.....	49
	Preparing the embroidery hoop.....	49
	Attaching the hoop.....	50
	Overview Embroidery hoop functions.....	51
	Centering the embroidery hoop to the needle.....	51
	Moving the hoop to the back.....	51
	Moving the embroidery arm to the left.....	51
	Grid on/off.....	52
	Locating the center of the embroidery motif.....	52
	Virtual positioning of the embroidery hoop.....	52

3 Setup Program..... 53

3.1	Embroidery settings.....	53
	Adjusting the upper thread tension.....	53
	Adjusting the maximum embroidering speed.....	53
	Centering the embroidery motif.....	53
	Calibrating the embroidery hoop.....	54
	Entering the fabric thickness.....	54
	Programming securing stitches (Smart Secure).....	55
	Adjusting the thread cut.....	55
3.2	Selecting personal settings.....	56
3.3	Monitoring functions.....	56
	Activating the upper thread indicator.....	56
	Activating the bobbin thread indicator.....	57
3.4	Activating the audio signals.....	57
3.5	Machine settings.....	58
	Selecting a language.....	58
	Adjusting the brightness of the display.....	58
	Adjusting the sewing light.....	58
	Calibrating the display.....	59
	Back to basic setting.....	59
	Deleting user data.....	59
	Deleting motifs on the BERNINA USB Stick.....	60
	Updating the machine Firmware.....	60
	Recovering saved data.....	61
	Cleaning the thread catcher.....	61
	Lubricating the machine.....	62
	Packing the embroidery module.....	62
	Checking the firmware version.....	63
	Reviewing the total number of stitches.....	63
	Registering details of the dealer.....	63
	Saving Service data.....	64
4	System settings.....	65
4.1	Calling up the tutorial.....	65
4.2	Calling up the embroidery consultant.....	65
4.3	Calling up the help.....	65
4.4	Using eco mode.....	65
4.5	Cancelling any alterations with «clr».....	65
5	Creative embroidering.....	66
5.1	Overview embroidering.....	66
5.2	Selecting and changing the embroidery motif.....	66
5.3	Checking the embroidery time and the embroidery motif size.....	66
5.4	Regulating the speed.....	66
5.5	Editing the embroidery motif.....	67
	Overview Editing embroidery motif.....	67
	Scaling up the embroidery motif view.....	67
	Downsizing the embroidery motif.....	67
	Moving the embroidery motif view.....	68

	Moving the embroidery motif in enlarged view.....	68
	Moving the embroidery motif.....	68
	Rotating the embroidery motif.....	69
	Altering the embroidery motif size proportionally.....	69
	Altering the embroidery motif size disproportionately.....	69
	Mirroring embroidery motifs.....	70
	Bending text.....	70
	Changing the stitch type.....	70
	Altering the stitch density.....	71
	Checking the embroidery motif size and position.....	71
	Endless embroidery.....	72
	Duplicating the embroidery motif.....	74
	Deleting the embroidery motif.....	74
5.6	Pinpoint placement.....	75
	Positioning of grid points.....	75
	Free point positioning.....	75
5.7	Combining embroidery motifs.....	76
	Combining embroidery motifs.....	76
	Deleting a single embroidery motif.....	77
	Duplicating the embroidery motif.....	78
	Duplicating a combination.....	78
5.8	Creating lettering.....	79
	Overview embroidery alphabets.....	79
	Creating words/sentences.....	80
	Editing words/sentences.....	81
5.9	Changing the colors of the embroidery motif.....	82
	Overview changing the color.....	82
	Changing the colors.....	82
	Changing the thread brand.....	82
5.10	Embroidering the embroidery motif.....	83
	Overview Embroidery menu.....	83
	Adding basting stitches.....	83
	Moving the hoop.....	83
	Embroidery sequence control when thread breaks.....	84
	Cutting connecting stitches.....	84
	Reducing color changes.....	84
	Multi-colored embroidery motif on/off.....	84
	Endless Embroidery.....	85
	Color indication.....	86
5.11	Administering embroidery motifs.....	86
	Administering embroidery motifs.....	86
	Saving embroidery motifs in the personal memory.....	86
	Saving the embroidery motif on the BERNINA USB stick.....	86
	Overwriting the embroidery motif in the personal memory.....	87
	Overwriting the embroidery motif on the BERNINA USB stick.....	87
	Loading an embroidery motif from the personal memory.....	87
	Loading an embroidery motif from the BERNINA USB stick.....	87
	Deleting an embroidery motif from the personal memory.....	88
	Deleting an embroidery motif from the BERNINA USB stick.....	88

6 Embroidery	89
6.1 Embroidering via the button «Start/Stop»	89
6.2 Increasing the embroidery speed	89
6.3 Adjusting the upper thread tension	90
6.4 Embroidering via the foot control (Optional accessory)	90
7 Attachment	91
7.1 Maintenance and cleaning	91
Cleaning the display	91
Removing thread remnants under the stitch plate	91
Lubricating the machine	91
Cleaning the hook	92
Lubricating the hook	93
7.2 Troubleshooting	95
7.3 Error messages	98
7.4 Storage and disposal	101
Storing the machine	101
Dispose of the machine	102
7.5 Technical data	103
8 Overview motifs	104
8.1 Overview Embroidery motifs	104
Editing embroidery motifs	104
Projects	105
Quilt motifs	106
Borders and Lace	111
Children	116
Flowers	121
Seasons	127
Embellishment	131
Sport	136
Asia	140
Charming Monograms	143
Animals	149
DesignWorks design	151
Monograms in pink	154
Monograms in blue	159
Index	164

IMPORTANT SAFETY INSTRUCTIONS

Please be aware of the following basic safety instructions when using your machine. Before using this machine, read instruction manual carefully.

DANGER!

To reduce the risk of electrical shock:

- Never leave the machine unattended as long as it is plugged in.
- Always unplug the machine from the electrical outlet immediately after using and before cleaning.

Protection against LED radiation:

- Do not view the LED light directly with optical instruments (e.g. magnifier). The LED light corresponds with protection class 1M.

WARNING

To reduce the risk of burns, fire, electric shock or injury to persons:

- Use this machine only for purposes as described in this manual.
- Do not use the machine outdoors.
- Do not use this machine as a toy. Close attention is necessary when this machine is used by or near children.
- The machine can be used by children older than 8 or by people with reduced physical, sensory or mental capabilities or if there is a lack of experience and knowledge how to operate the machine as long as they are supervised or have been given instruction concerning the responsible use of the appliance and are aware of the involved risks.
- Children are not allowed to play with this machine.

- Cleaning and maintenance work must not be carried out by children unless they are supervised.
- Never operate this machine if it has a damaged cord or plug, if it is not working properly, if it has been dropped or damaged, or dropped into water. Contact the nearest authorized BERNINA dealer to arrange further details.
- Only use accessories recommended by the manufacturer.
- Don't use this machine when the ventilation openings are blocked. Keep the ventilation openings free from the accumulation of lint, dust and loose cloth.
- Never insert any objects into any openings of the machine.
- Do not operate the machine where aerosol products (sprays) or oxygen are being used.
- Keep fingers away from all moving parts. Special care is required around the needle.
- When making any adjustments in the needle area – such as such as threading the needle, changing the needle, threading the hook or changing the presser foot – turn power switch to «0».
- Do not use bent needles.
- Always use the original BERNINA stitch plate. The wrong stitch plate can cause needle breakage.
- To disconnect, turn power switch to «0» and remove the plug from the outlet. Do not unplug by pulling the cord, instead grasp the plug to pull it from the outlet.
- Always disconnect the power plug from the electrical outlet when the covers are removed or opened, when the machine is lubricated or during any other maintenance adjustments mentioned in the instruction manual.

- This machine is provided with double insulation (except USA, Canada and Japan). Use only identical replacement parts. See instructions for Servicing of double-insulated products.

Servicing double-insulated products

In a double-insulated product two systems of insulation are provided instead of grounding. No grounding means is provided on a double-insulated product, nor should a means for grounding be added to the product. Servicing a double-insulated product requires extreme care and best knowledge of the system and should be done only by qualified service personnel. Replacement parts for a double-insulated product must be identical to the original parts in the product. A double-insulated product is marked with the words: «Double Insulation» or «double-insulated».

The symbol may also be marked on the product.

SAVE THESE INSTRUCTIONS!

Appropriate use

Your BERNINA machine is conceived and designed for private household use. It answers the purpose to embroider fabrics and other materials as it is described in this instruction manual. Any other use is not considered appropriate. BERNINA assumes no liability concerning consequences resulting from an inappropriate usage.

1 My BERNINA

1.1 Introduction

Your BERNINA 700 provides various creative applications. Delicate silk or satin fabrics as well as heavy-weight linen, fleece and denim can be embroidered without any problems with this machine. Numerous embroidery motifs are at your disposal.

Additional to this instruction manual, three help programs are provided which will give you useful advice and support at any time how to operate your BERNINA 700.

The **Tutorial** gives information and explanations, covering various aspects of embroidering.

The **Embroidery Consultant** informs you about decision support for embroidery projects. After entering the kind of fabric and the desired embroidery project, suggestions concerning the suitable needle or the appropriate embroidery foot are displayed.

The **Help Program** contains information about individual embroidery motifs, functions and applications in the User Interface.

Further information

In addition to this instruction manual of your BERNINA 700 further information products are enclosed.

The latest version of your instruction manual as well as additional information in connection with the machine and accessories can be found on our website <http://www.bernina.com>

1.2 Welcome to the world of BERNINA

Made to create, this is the slogan of BERNINA. Not only our machines do support you to implement your ideas, but on top of that, our below mentioned opportunities also offer various inspirations and instructions for your future projects as well as the option to exchange ideas with other sewing and embroidering enthusiasts. We wish you lots of pleasured doing that.

inspiration – the sewing magazine

Are you looking for ideas, sewing patterns and instructions for great projects? In that case the BERNINA magazine «inspiration» is exactly what you need. «inspiration» offers extraordinary sewing and embroidery ideas four times a year. From seasonal fashion trends to trendy accessories and practical tips to decorate your home in an original way.

<http://www.bernina.com/inspiration>

The magazine is available in the languages English, German, Dutch and French. Not available in all countries.

BERNINA Blog

Fancy instructions, free sewing patterns and embroidery motifs as well as many new ideas: all this you can find in the weekly blog by BERNINA. Our experts give valuable tips and explain step by step how you can achieve the desired result. In the community you can upload your own projects and exchange experiences and ideas with other sewing and embroidering enthusiasts.

<http://www.bernina.com/blog>

Provided in the languages English, German and Dutch.

BERNINA YouTube Channel

On YouTube we offer a wide range of how-to videos and support concerning the most important functions of our machines. Detailed explanations are also provided as for the various presser feet, so that your projects will succeed completely.

<http://www.youtube.com/BerninaInternational>

Provided in the languages English and German.



BERNINA Social Media

Follow us on the social networking to learn more about events, thrilling projects as well as tips and tricks all about sewing and embroidering. We will keep you informed and we are looking forward to presenting you the one or the other highlight from the world of BERNINA.

<http://www.bernina.com/social-media>

1.3 Key to signs



Labels a danger with a high risk which can lead to death or severe injury unless it is avoided.



Labels a danger with a medium risk which can lead to death or severe injury unless it is avoided.



Labels a danger with a low risk which can lead to light or medium injury unless it is avoided.



Labels a danger which can end up with damage unless it is avoided.



Tips by BERNINA **Embroidery experts** can be found next to this sign.

By means of illustration, sample pictures are used in this instruction manual. The machines as well as the accessory shown in the pictures may vary from the delivery content of your machine.

All specification is given in millimeter (mm).

1.4 Overview Machine

Overview front controls



- | | | | |
|---|---|----|----------------------------|
| 1 | Sewing light on/off | 7 | Checking motif size |
| 2 | Thread cutter | 8 | Bobbin thread up |
| 3 | Presser foot up/down | 9 | Upper Multifunctional knob |
| 4 | Start/Stop | 10 | Lower Multifunctional knob |
| 5 | Centering the embroidering hoop to the needle | 11 | Pinpoint placement |
| 6 | Moving the hoop to the back | 12 | Motif center |

Overview front



- | | | | |
|---|--------------------------------------|----|-----------------------------------|
| 1 | Connection for the embroidery module | 6 | Slide speed control |
| 2 | Bobbin cover | 7 | Thread take-up lever cover |
| 3 | Embroidery foot | 8 | Thread take-up lever |
| 4 | Needle threader | 9 | Fixing screw |
| 5 | Sewing light | 10 | Connection for the slide-on table |

Overview sideways



- | | | | |
|---|---------------------------------|----|---------------------------------------|
| 1 | Connection for the foot control | 7 | Power switch |
| 2 | PC-connection | 8 | Connection for the power cable |
| 3 | Spool pin | 9 | Magnet holder for the touchscreen pen |
| 4 | Winding unit with thread cutter | 10 | Air vents |
| 5 | Swiveling spool pin | 11 | USB port |
| 6 | Handwheel | | |

Overview back

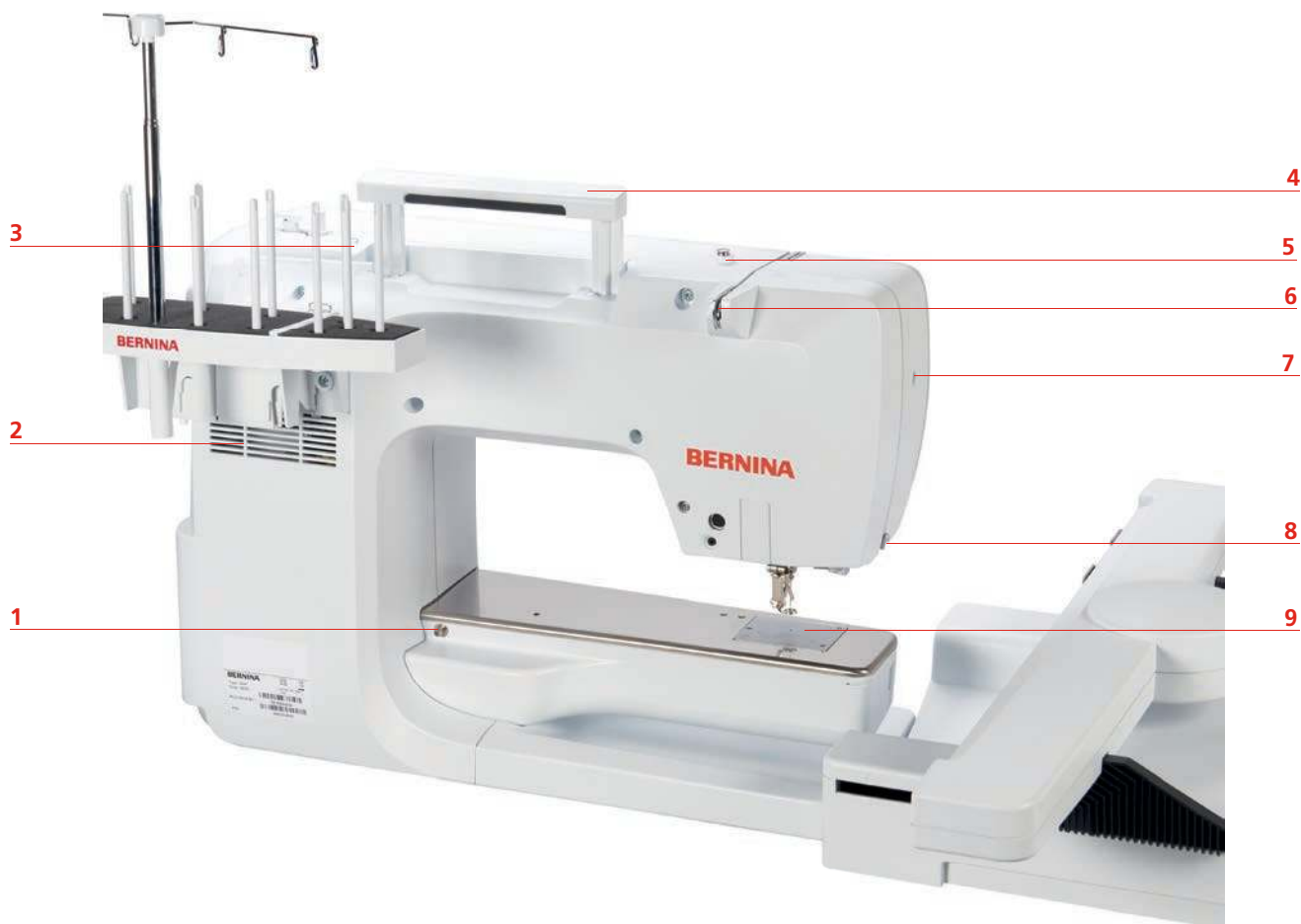

- | | | | |
|---|-----------------------------------|---|---------------|
| 1 | Connection for the slide-on table | 6 | Thread guide |
| 2 | Air vents | 7 | Fixing screw |
| 3 | Thread guide | 8 | Thread cutter |
| 4 | Carrying handle | 9 | Stitch plate |
| 5 | Thread pretension | | |















Illustration	Name	Purpose
	Soft cover with pocket	The soft cover protects the machine from dust and contamination.
	Accessory box	The accessory box serves the purpose to store the supplied accessories as well as the optional accessories.
	Multiple-spool holder	The multiple-spool holder allows a quick access and color change. This is especially of advantage with multi-color embroidery motifs. In addition to that, the way to the needle through the telescope spool pin is longer, which means that delicate yarns can be already untangled before embroidering.
	3 Spool discs	Spool discs hold the thread spool in place for proper release of thread from the spool.
	4 bobbins in the accessory, whereas 1 bobbin is in the machine	The bobbins are filled with the bobbin thread.
	2 Foam pads	The foam pad prevents the thread from getting hooked at the spool pin.
	Touchscreen pen	The operation of the display is more precise when using the touchscreen pen instead of the fingers.
	Seam ripper	The seam ripper is an indispensable tool to undo stitches.
	Screwdriver Torx, gray	Use the gray screwdriver Torx to change the needles.
	Screwdriver red	The red screwdriver is supplied as an all-round tool.

Illustration	Name	Purpose
	Angular Torx button	Using the angular Torx wrench the headframe can be opened.
	Brush	Clean the hook area with the brush.
	Lubricator	The lubricator is used to fill up the oil depots.
	Power cable	The power cable connects the machine with the power supply system.

Use of the power cable (only USA/Canada)

The machine has a polarized plug (one blade wider than the other). To reduce the risk of electrical shock, this plug is intended to fit in a polarized outlet only one way. If the plug does not fit fully in the outlet, reverse the plug. If it still does not fit, contact a qualified electrician to install the proper outlet. Do not modify the plug in any way!

Foot control (only USA/Canada) (Optional accessory)

Use only foot controller type LV-1 with BERNINA 700.

Accessory box









All rights reserved: For technical reasons and for the purpose of product improvements, changes concerning the features of the machine can be made at any time and without advance notice. The supplied accessory can vary depending on the country of delivery.

The illustrated accessory (kind and quantity) serves as an example and doesn't have to correspond with the supplied accessory.



- | | | | |
|---|----------------------|---|------------------------------------|
| 1 | Big drawer | 5 | Embroidery foot |
| 2 | Small drawer | 6 | Embroidery foot holder 9.0 mm-feet |
| 3 | Selection of needles | 7 | Embroidery foot holder 5.5 mm-feet |
| 4 | Spool pin | | |

Overview Accessory Embroidery module

Illustration	Name	Purpose
	Embroidery foot No.26	For embroidering, darning and free-motion quilting.
	Embroidery hoop oval, 145 x 255 mm with embroidery template, VAR 00	To embroider large embroidery motifs. The embroidery template serves the purpose to calibrate the embroidery hoop and to place the fabric exactly.
	Embroidery hoop medium, 100 x 130 mm with embroidery template	To embroider medium-sized embroidery motifs. The embroidery template serves the purpose to calibrate the embroidery hoop and to place the fabric exactly.
	Embroidery hoop small, 72 x 50 mm with embroidery template	To embroider small embroidery motifs. The embroidery template serves the purpose to place the fabric exactly.
	USB Connecting cable	The USB connecting cable serves the purpose to transfer data. When the embroidery software (Optional accessory) is installed on the computer, embroidery motifs can be transferred from the computer to the machine.
	Embroidery needle assortment SUK	Various needle sizes for embroidering.
	Template holder	The template holders serve as a help when placing and removing the template in and from the embroidery hoop.
	Net for thread spool, white	The spool net provides an even unwinding of the thread when using slippery embroidery threads.

1.6 Overview User Interface

Overview Functions and Views



- | | | | |
|---|---|---|---|
| 1 | Upper thread tension | 4 | Embroidery hoop display/Embroidery hoop selection |
| 2 | Needle selection | 5 | Stitch plate selection |
| 3 | Presser foot display/Presser foot selection | 6 | Fill level of bobbin thread |

Overview System settings











- | | | | |
|---|-----------------------|---|-----------------------|
| 1 | Home | 5 | Help |
| 2 | Setup Program | 6 | eco mode |
| 3 | Tutorial | 7 | Back to basic setting |
| 4 | Embroidery consultant | | |

Overview Selection menu

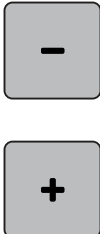
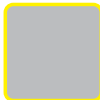

- | | | | |
|---|-----------------------------|---|-------------------|
| 1 | Selection embroidery motifs | 3 | Color information |
| 2 | Editing embroidery motifs | 4 | Embroidery |

Overview Icons



Icon	Name	Purpose
	i-Dialog	Touching the icon «i»-Dialog provides various functions to edit motifs.
	Close	The window is closed and the previously made adjustments are saved.
	Icons «-/+»	By touching the icons «-» and «+» the setting values are changed.
	Yellow frame around the icon	A yellow-framed icon indicates that the setting or the value for this function has been changed. By touching the yellow-framed icon, the basic setting is restored.
	Confirm	Confirms any adjusted settings. The window is closed.
	Cancel	The process is canceled. The screen is closed and the previously made adjustments are not saved.
	Slide	By moving the slide the setting values are changed.
	Switch	Activates or deactivates functions.
	Process navigation	With the process navigation scrolling back in the display is possible.
	Swipe function	By swiping the display using the touchscreen pen or the finger upwards or downwards, further functions can be displayed.

1.7 Needle, Thread, Fabric

In the course of time a needle wears out. Therefore it should be replaced regularly. Only a perfect point results in a proper stitch. In general it can be said: the thinner the thread, the finer the needle. The illustrated needles are either standard or optional accessory, depending on the machine.

- Needle sizes 70, 75: for thin fabrics.
- Needle sizes 80, 90: for medium fabrics.
- Needle sizes 100, 110 and 120: for heavy fabrics.

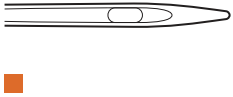
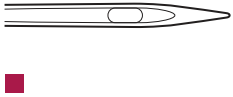
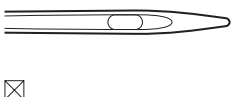
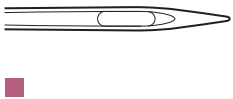
Overview needles

Illustration	Needle name	Needle description	Purpose
	Jersey/Embroidery needle 130/705 H SUK 60-100	Medium ball point	Knitware, embroidery.
	Embroidery needle 130/705 H-E 75, 90	Small ball point, especially large needle eye and wide thread groove	Embroidery on all natural and synthetic fabrics.
	Fine material needle 130/705 H SES 70, 90	Fine ball point	Fine knitware, embroidering fine, delicate fabrics.
	Metafil needle 130/705 H METAFIL 80	Long needle eye (2 mm) in all needle sizes	Sewing projects with metallic threads.
	Felt needle PUNCH	Needle with barbed hook	Felt work.

Example of needle description

The 130/705 system, which is the most common for household machines, is explained by the following picture of a Jersey/Stretch needle.

	<p>130/705 H-S/70</p> <p>130 = Shank length (1)</p> <p>705 = Flat shank (2)</p> <p>H = Needle scarf (3)</p> <p>S = Needle point (here medium ball point) (4)</p> <p>70 = Needle size (shank diameter) (5)</p>
---	---

Needle/thread combination

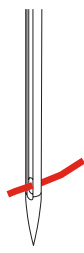
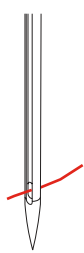
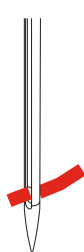
	<p>The needle/thread combination is correct, when the thread fits perfectly into the long groove and goes easily through the needle eye. The thread can be optimally sewn.</p>
	<p>The thread can break and skipped stitches can occur when there is too much clearance in the long groove and the needle eye.</p>
	<p>The thread can break and get stuck when the thread scrapes against the edge of the long groove not fit well into the needle eye optimally.</p>

Upper thread

A good quality thread (name-brand manufacturer) is essential for embroidery so that the embroidery is not affected negatively because of poor thread or thread breakage.

Embroidery is particularly effective if you use 40wt glossy rayon or polyester embroidery threads as upper threads. They are available in a wide range of colors for beautiful embroidery.

- Polyester with a brilliant sheen is a hard-wearing, colorfast thread and has a high tensile strength which is suitable for all types of embroidery.
- Rayon is a soft viscose fiber with a brilliant sheen and suitable for fine, delicate embroidery, or items that will not receive excessive wear and tear.
- Metallic thread is a light to medium-weight thread suitable for special effects in embroidery.
- When working with metallic threads, the automatic bobbin thread cutter should be deactivated. The other thread cutters shouldn't be used either because the knives are likely to wear off very quickly.
- When using metallic threads, the speed and the upper thread tension should be reduced.



Bobbin thread

In most cases black or white bobbin thread is used for embroidering. When both sides should have the same look, it is recommended to use the same color for bobbin and upper thread.

- Bobbin Fill is an especially soft and light polyester thread which is suited well to be used as bobbin thread. This special bobbin thread ensures a steady thread tension and an optimal intertwining of the upper and bobbin thread.
- Fine mercerized cotton thread which is suitable for embroidery on cotton.



1.8 Important Embroidery information

Choosing the embroidery motif

Simple motifs with a low stitch count are suitable for embroidery on fine material. Densely embroidered motifs, e. g. embroidered motifs with multiple color and embroidery direction changes, are suitable for medium and heavy-weight material.

Embroidery test

For the embroidery test, always use the original material reinforced with the same stabilizer as will be used later. For the embroidery test it is recommended to use the same colors, threads and needles which are planned to be used for the embroidery project.

Step stitch

Many short, equally long stitches are embroidered in offset rows closely next to each other which results in a densely filled area.

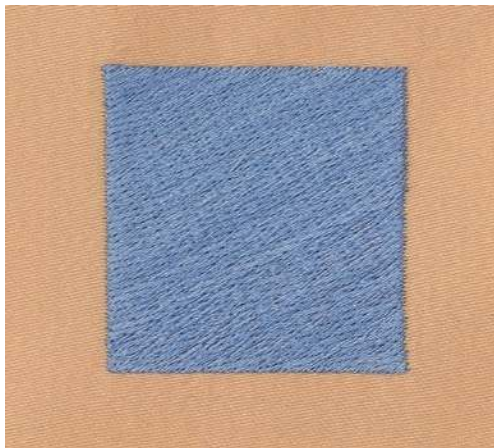

Connecting stitches

Long stitches which are used to get from one part of the motif to the next. Before and after the connecting stitch securing stitches are sewn. Connecting stitches are trimmed.

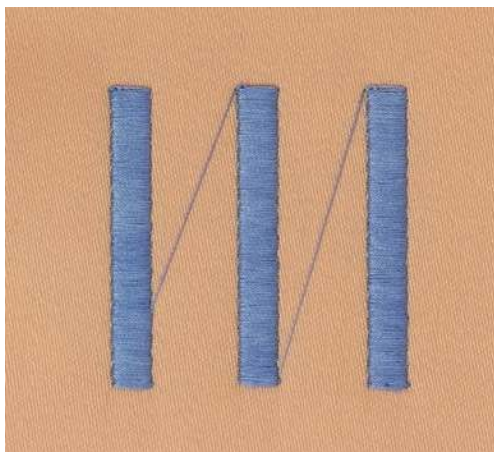

2 Embroidery preparation

2.1 Accessory box

Accessory box free standing

- > On the back of the box, pull both extensions out until they click into place.



Storing accessory

NOTICE

Incorrect sorting of the bobbin

The silvery sensor surface can get scratched.

- > Make sure that the silvery sensor surfaces are on the right side when sorting the bobbins into the accessory box.

- > Insert the holders (1) for bobbins, feet and needles.
- > Store the small parts, e.g. thread discs etc., in the drawers (2) and (3).
- > Store the provided needle package in the special compartment (4).
- > Insert the bobbins into the compartment (5) of the accessory box so that the silvery sensor surfaces are on the right side.
- > To remove a bobbin, press the compartment holder down.
- > Store the embroidery feet (5.5 mm or 9.0 mm) in the holders (6).

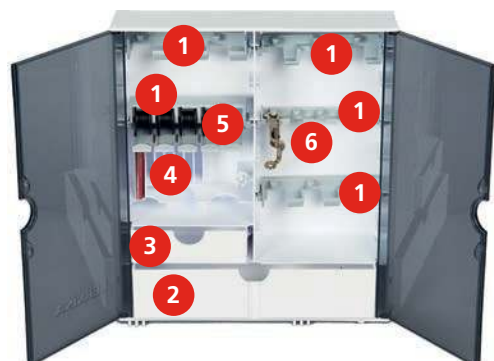

2.2 Connection and Switching on

Connecting the foot control (Optional accessory)

- > Unwind the cable of the foot control to the desired length.



- > Insert the cable of the foot control into the foot control connection.



Connecting the machine

- > Insert the power cable into the power cord connection.



- > Insert the plug of the power cable into the electrical outlet.

- > Release the foot control to stop the machine.



Raising/Lowering the needle

- > Sink the heel back on the foot control to raise/lower the needle.



2.4 Spool pin

Swiveling spool pin

Installing the spool pin



With metallic or other special threads, it is recommend to use the swiveling spool pin.

The swiveling spool pin is used when special threads are embroidered and it can also be used for winding during embroidering.

- > Swivel the spool pin up as far as it will go.



Inserting foam pad and thread spool

The foam pad prevents the thread from getting hooked at the swiveling spool pin.

- > Place the foam pad on the swiveling spool pin.
- > Place the thread spool on the spool pin.



Horizontal spool pin

Placing the foam pad, the thread spool and the thread disc

Spool discs hold the thread spool in place for proper release of thread from the spool. The thread disc is only used with the horizontal spool pin.

- > Place the foam pad on the spool pin.
- > Place the thread spool on the spool pin.
- > Position the appropriate spool disc on the spool pin so that there is no space between the spool disc and the thread spool.



Using a spool net

The spool net provides an even unwinding of the thread from the thread spool and prevents the thread from knotting and breaking. The spool net is only used with the horizontal spool pin.

- > Place the thread spool on the spool pin.
- > Pull the spool net over the thread spool.



Attaching the multiple-spool holder

Additional information how to assemble the multi-spool pin can be found in the separate instruction manual of the multi-spool pin.

2.5 Free arm

The BERNINA 700 provides a solidly designed free arm which offers a lot of space for large project on the right of the needle.

2.6 Embroidery foot

Adjusting the presser foot position via the button «Presser foot up/down»



- > Press the button «Presser foot up/down» to raise the presser foot.
- > Press the button «Presser foot up/down» again to lower the presser foot.

Attaching the embroidery foot

- > Raise the needle.
- > Switch the machine off and disconnect it from the power supply system.
- > Push the clamping lever up.
- > Insert the embroidery foot from below into the bracket.



- > Press the clamping lever down.



Selecting the embroidery foot in the User Interface

After having attached the respective embroidery foot (Embroidery foot No. 26, supplied accessory with the embroidery module), you can select and save it on the machine. Moreover, alternative feet are displayed which will also be suitable for the selected embroidery motif.

- > Switch the machine on.
- > Select the embroidery motif.



> Touch the icon «Presser foot display/Presser foot selection».



> Touch the icon «Optional presser feet» to display all the suitable feet for the selected embroidery motif.
> Select the attached embroidery foot.



2.7 Needle and stitch plate

Inserting the embroidery needle



Embroidery needles of the type 130/705 H-SUK provide a larger eye and are slightly rounded. This avoids thread abrasion when using Rayon- and cotton embroidery thread. Depending on the embroidery thread use a size No. 70-SUK to No. 90-SUK needle.

- > Raise the needle.
- > Switch the machine off and disconnect it from the power supply system.
- > Remove the attached foot.
- > Loosen the fixing screw of the needle using the screwdriver gray Torx.



- > Pull the needle down.
- > Hold the new needle with the flat side to the back.
- > Insert the needle as far as it will go.
- > Tighten the fixing screw using the screwdriver gray Torx.

Selecting the needle in the User Interface

After having changed the needle, it can be checked whether it can be used in combination with the selected stitch plate.



- > Touch the icon «Needle selection».
- > Select the inserted needle.



- If the selected needle is suitable in combination with the stitch plate, embroidering can be started.
- If the selected needle is not suitable in combination with the stitch plate, starting the machine is automatically blocked.

Selecting needle type and needle size

Convenient memory function: To prevent a loss of information, the needle type and the needle size can be saved additionally on the machine. The saved needle type and the saved needle size can be checked at any time.



- > Touch the icon «Needle selection».



- > Touch the icon «Needle type/Needle size».
- > Select the needle type (1) of the inserted needle.
- > Select the needle size (2) of the inserted needle.



Attaching the stitch plate

The stitch plate has a small hole in the needle insertion area. The thread is pulled in and knotted optimally which results in an optimized stitching result.

Prerequisite:

- The machine is switched off and disconnected from the power supply system.
- The foot and the needle are removed.

- > Press the stitch plate down at the mark back right until it flips up.



- > Remove the stitch plate.
- > Place the openings of the stitch plate (PunchWork, Optional accessory) above the corresponding guide pins and press down until it clicks into place.



Selecting the stitch plate in the User Interface

After having changed the stitch plate, it can be checked whether it can be used in combination with the selected needle.



- > Touch the icon «Stitch plate selection».
- > Select the attached stitch plate (PunchWork, Optional accessory).



- If the selected needle is suitable in combination with the stitch plate, embroidering can be started.
- If the selected needle is not suitable in combination with the stitch plate, starting the machine is automatically blocked.

2.8 Threading

Threading the upper thread

Prerequisite:

- The needle and the foot are raised.
- The machine is switched off and disconnected from the power supply system.
- > Place the foam pad on the spool pin.
- > Place the thread spool on the spool pin so that the thread unwinds clockwise.
- > Place the appropriate thread disc.

- > Guide the thread in direction of the arrow through the rear thread guide (1) and hold the thread with the hands so that it is taut and can be inserted into the thread tension.
- > Guide the thread in direction of the arrow through the thread tension (2).



- > Guide the thread downwards (3) around the thread take-up lever cover (4).
- > Guide the thread upwards and insert into the thread take-up lever (5).
- > Guide the thread downwards again (6).



- > Guide the thread through the guides (7/8) above the foot.



- > Switch the machine on.

- > Press the semi-automatic threader lever (9) slightly down, keep pressed and pull the thread to the left beneath the gray threader hook (10).

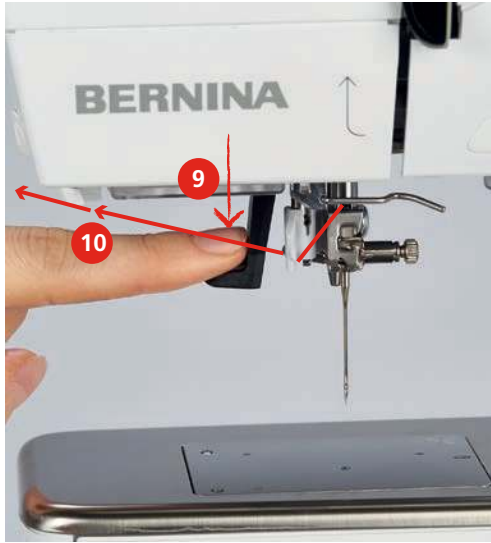

- > Guide the thread around the gray threader hook from the left to the right (12).
- > Press the threader lever down as far as it will go (11) and then pull the thread from the left to the right (12) through the threader slot (13) until it hooks into the small wire hook.

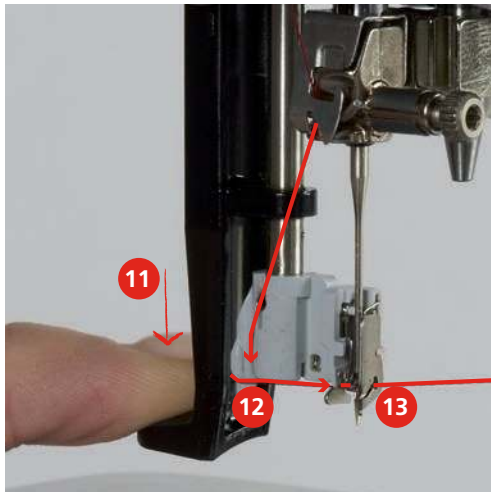

- > Release the lever and the thread simultaneously to thread.



- > Pull the thread loop (14) to the back.

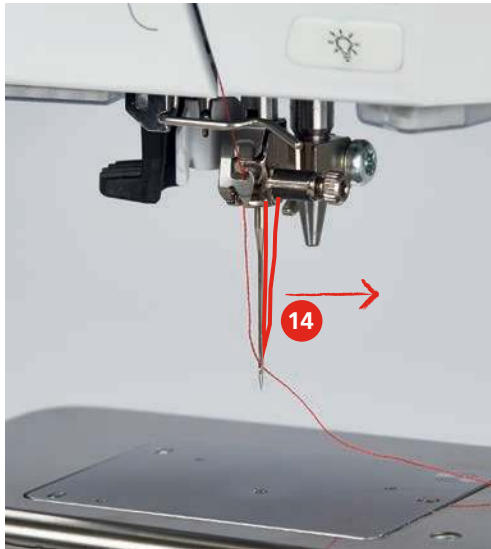

- > Pull the thread beneath the attached foot from back to front over the thread cutter (15) and cut.



Winding the bobbin thread



The bobbin thread can be wound while embroidering if the swiveling spool pin is used for winding.

Prerequisite:

- The foam pad, the thread spool and the appropriate thread disc are positioned.
- > Attach the empty bobbin on the winding unit (1) so that the silvery sensor surface is down.



- > Guide the thread to the left into the rear thread guide (2).
- > Guide the thread around the thread pretension clockwise (3).

- > Wind the thread clockwise 2 to 3 times around the empty bobbin (4).

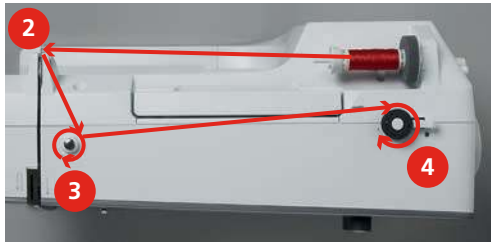

- > Pull the excess thread over the thread cutter at the engaging lever (5) and cut.



- > Push the engaging lever (6) towards the bobbin.

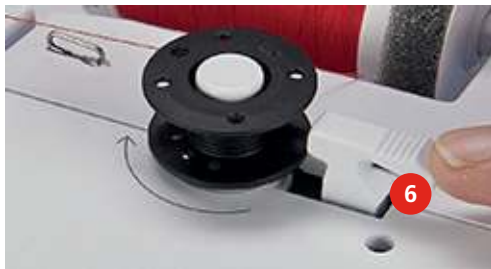

- The machine winds and the display to wind the bobbin appears.
- > Move the slide on the display using the touchscreen pen or the finger to adjust the winding speed.
- > To stop the winding process, the engaging lever must be pressed to the right.
- > Push the engaging lever towards the bobbin again to continue the winding process.
 - As soon as the bobbin is full, the machine stops the winding process automatically.
- > Remove the bobbin and cut the thread using the thread cutter at the engaging lever.

Threading the bobbin thread

Prerequisite:

- The needle is raised.
- The machine is switched off and the bobbin cover is opened.

- > Press the bobbin case release at the bobbin case (1).

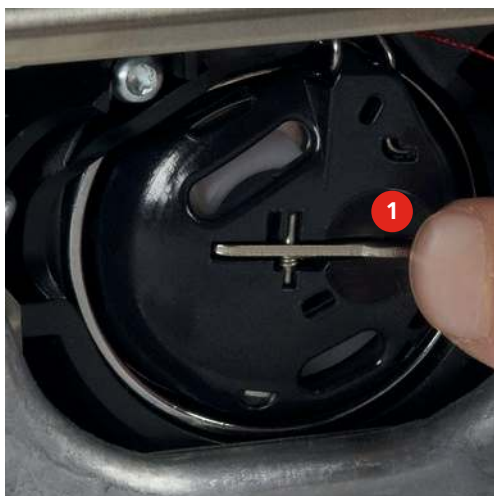

- > Remove the bobbin case.
- > Remove the bobbin from the bobbin case.
- > Insert the new bobbin so that the silvery sensor surface is facing the back of the bobbin case.



- > Pull the thread into the slot (2) from the left.



- > Pull the thread to the right under the spring (3), then lead the thread under the two thread guides (4) and pull upwards.



- > When inserting into the machine, hold the bobbin case so the the thread guide (5) points upwards.



- > Insert the bobbin case.
- > Press onto the center of the bobbin case until it engages.
- > Pull the thread through the thread cutter (6) and cut.

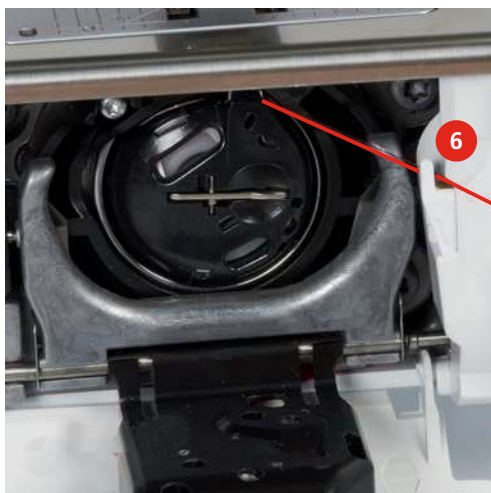

- > Close the bobbin cover.



Thread-up command

The machine has to be ready for embroidering to bring up the bobbin thread.



- > Hold the upper thread.
- > Push the button «Bobbin thread up».
 - The bobbin thread is brought up automatically.

Indicating fill level of bobbin thread

As soon as the fill level of the bobbin thread is low, an animation, which indicates that the bobbin thread is running out, appears in the icon «Bobbin thread fill level».



- > Touch the icon «Bobbin thread fill level» to thread the bobbin thread according to the animation.

2.9 Attaching the Module

NOTICE

Transporting the embroidery module

Damage to the embroidery module connection and machine.

- > Remove the embroidery module before transporting the machine.

Prerequisite:

- The slide-on table (Optional accessory) must not be attached.
- > Make sure that the module and the machine are placed on a stable, even surface.
- > Make sure that there is enough space around to allow the unimpeded movement of the embroidery arm.
- > Lift the embroidery module on the left.
- > Carefully push the module from left to right into the embroidery module connection (1) of the machine.

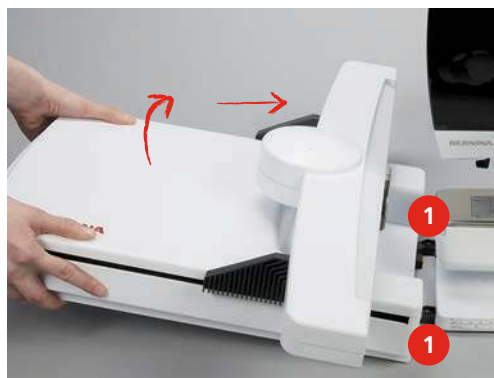

- > To remove, lift the embroidery module on the left and carefully pull to the left.



2.10 Selecting the embroidery motif

All embroidery motifs can either be embroidered as-is or edited using the various functions offered by the embroidery machine. All embroidery motifs can be found in the attachment (see page 104). In addition to that, embroidery motifs can be loaded from the personal memory or from the BERNINA USB stick (Optional accessory).

Prerequisite:

- The Embroidery foot No. 26 is attached.
- > Select an alphabet, embroidery motif or a personal embroidery motif from one of the files.



2.11 Embroidery hoop

Overview embroidery hoop selection



- 1 Hoop selection

Selecting the embroidery hoop

The best embroidery result is achieved when the smallest possible embroidery hoop for the embroidery motif is selected.

The embroidery motif has a pre-set size which is displayed.

Prerequisite:

- The embroidery motif is selected.



- > Touch the icon «Hoop selection».
 - The machine selects the optimal embroidery hoop according to the size of the embroidery motif automatically. If the pre-set embroidery hoop would not be available, another desired embroidery hoop can be selected. When an embroidery hoop is attached which does not correspond with the selected one, the attached hoop is considered active and the embroidery motif area is displayed accordingly.
- > Select the desired embroidery hoop.

Tear-away stabilizers

Using a stabilizer ensures more stability of the embroidery project. A tear-away stabilizer suits all woven and non-stretch materials. 1 – 2 layers can be used. Stabilizers are available in different weights. With larger embroidered areas the stabilizer will remain under the embroidery thread. The stabilizer is applied to the wrong side of the fabric with temporary adhesive spray. Carefully tear away excess stabilizer after embroidering.

Cut-away stabilizers

Using a stabilizer ensure more stability of the embroidery project. A cut-away stabilizer suits all elastic materials. 1 – 2 layers can be used. Stabilizers are available in different weights. With larger areas to be embroidered the stabilizer will remain under the embroidery thread. The stabilizer is applied to the wrong side of the fabric with temporary adhesive spray. Carefully cut away excess stabilizer after embroidering.

Using adhesive spray

The application of spray adhesive is recommended for stretch and smooth materials and knitware. It prevents the fabric from losing shape and slipping. Appliqués can be exactly positioned with spray adhesive. The spray adhesive shouldn't be used near the machine to avoid contamination.

- > Use the spray adhesive carefully at a distance 25 – 30 cm when spraying the stabilizer.
- > Adhere the sprayed stabilizer to the wrong side of the fabric carefully, smoothing material so there are no puckers.
- > Position smaller parts such as pocket flaps or collars on the stabilizer.
- > To avoid the possibility of getting hoop marks when working with napped materials or fleece, don't hoop the parts but spray the stabilizer and hoop it.
- > Adhere the fabric to be embroidered.
- > Remove any adhesive residue before starting the machine.

Using spray starch

Spray starch is ideal for additional stiffening fine, loosely woven materials. Always use an additional stabilizer on the wrong side of the material.

- > Spray the area to be embroidered.
- > Let it dry or press gently with a warm iron if necessary.

Using iron-on interfacing

Iron-on interfacings are available in a variety of weights. It is recommended to use an iron-on interfacing which is easily removable from the basic fabric. An Iron-on interfacing suits all materials that are easily distorted like stretch fabric such as tricot and jersey.

- > Iron-on interfacings are ironed to the wrong side of the material using a warm iron.

Using paper-backed adhesive stabilizer

Paper-backed adhesive stabilizers are intended to be used for fabrics such as jersey and silk as well as for embroidery projects which are not suited to be hooped in the embroidery hoop.

- > Place the stabilizer in the hoop, so that the paper side is up.
- > Use a pair of scissors to score the paper and remove paper in the hoop area.
- > Position the fabric to be embroidered on the stabilizer and press it on place.
- > Remove any adhesive residue before starting the machine.

Using water-soluble stabilizer



For lace embroidery it is recommended to hoop 1 - 3 layers of water-soluble stabilizer in the embroidery hoop. As the embroidery motif is not embroidered on the fabric, only the thread embroidered motif is left. The embroidery motifs should be combined with short stitches otherwise the individual motifs may fall out.

The stabilizer dissolves in water. Water-soluble stabilizers are an ideal protection for looped pile fabrics preventing the loops from being damaged! It prevents threads from sinking into the material and keeps the fabric pile from poking through the embroidery. Water-soluble stabilizers are ideal for fine, sheer fabrics where other stabilizers may show through the embroidery stitches as well as for lace embroidery.

- > Place the stabilizer on top of the material.
- > Place all the layers together into the embroidery hoop.
- > Use adhesive spray to adhere stabilizer if necessary.
- > For material with a pile, reinforce with additional, suitable stabilizer on the wrong side. In addition to that a water-soluble stabilizer can be placed on top of the material and fixed with basting stitches.
- > After dissolving, lay the motif down flat and let dry.

Preparing the embroidery hoop

The embroidery hoop consists of an outer and an inner hoop. There is a corresponding template for every hoop. The area to be embroidered is marked in 1 cm squares. The center and corner points are marked with holes. The required marks can be transferred to the material.

- > Mark the center of the embroidery motif on the fabric, using a water-soluble pen.

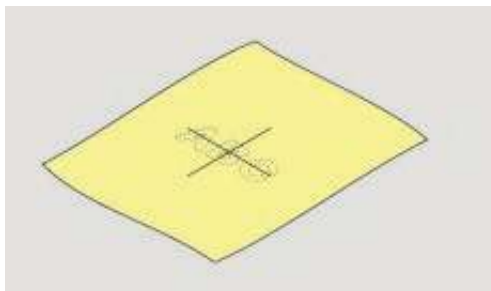

- > Loosen the screw on the outer hoop.
- > Remove the inner hoop.
- > Make sure that the arrows marks of both hoops match.
- > Attach the template holder.

- > Place the template in the inner hoop, so the BERNINA logo is at the front edge at the arrow mark until it clicks into place.

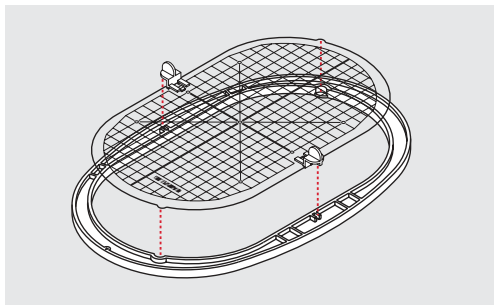

- > Place the material under the inner hoop.
- > Line up the marked center point on the center of the template.
- > Place the material and the inner hoop on the outer hoop so that the arrows of both hoops match.

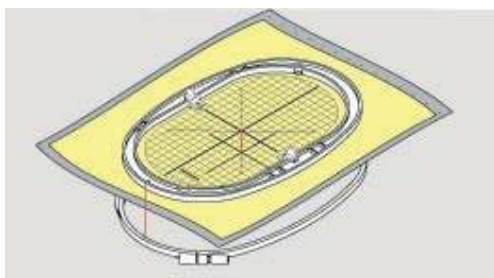

- > Fit the hoops into each other; ensure that the material does not move.
- > Hoop the fabric to be embroidered tightly.
- > Tighten the screw.
- > Remove the template from the hoop by using the template holder.

Attaching the hoop

- > Raise the needle.
- > Raise the embroidery foot.
- > Hold the hoop with the right side of the fabric up with the attaching mechanism to the left.
- > Position the hoop under the embroidery foot.
- > Press both attaching mechanisms (1) of the hoop towards each other.
- > Position the embroidery hoop (2) above the bracket of the embroidery arm.
- > Press the hoop down until it clicks in position.
- > Release the attaching mechanism (1).

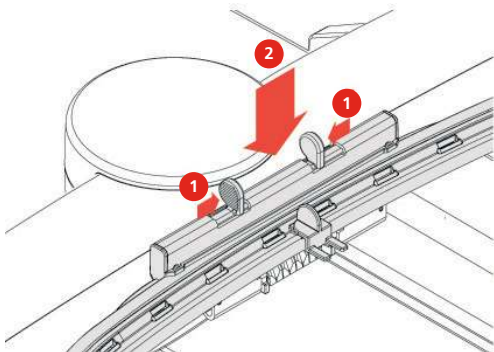

- > Press the attaching mechanisms of the hoop towards each other to remove the hoop.
- > Remove the hoop.

Overview Embroidery hoop functions

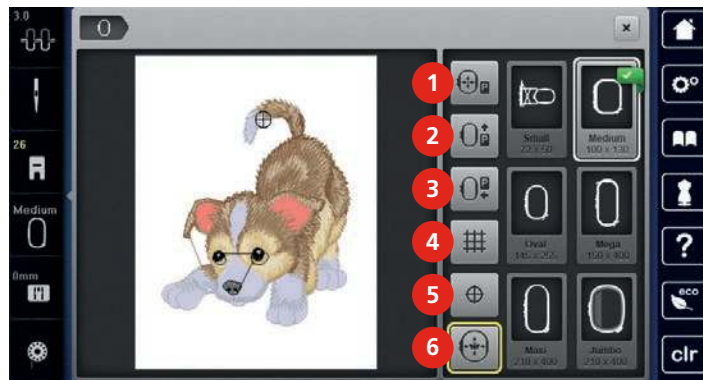

- | | | | |
|---|---|---|---------------------|
| 1 | Centering the embroidery hoop to the needle | 4 | Grid on/off |
| 2 | Moving the hoop to the back | 5 | Motif center |
| 3 | Moving the embroidery arm to the left | 6 | Virtual positioning |

Centering the embroidery hoop to the needle

Relocating the embroidery hoop facilitates threading when the needle is close to the embroidery hoop.



- > Touch the icon «Embroidery hoop display/Embroidery hoop selection».



- > Touch the icon «Center the embroidery hoop to the needle» or



- > Push the button «Center the embroidery hoop to the needle».
- > Thread the upper thread (see page 39).



- > Press the button «Start/Stop» to move the embroidery hoop back to the last position.

Moving the hoop to the back

To facilitate changing the bobbin, it is recommended to move the hoop to the back before threading. This makes it easier to open the bobbin cover.



- > Touch the icon «Embroidery hoop display/Embroidery hoop selection».

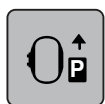

- > Touch the icon «Move the hoop to the back» or



- > Push the button «Move the hoop to the back».
- > Thread the bobbin thread (see page 43).



- > Push the button «Start/Stop» to move the embroidery hoop back to the last position. Pull the upper thread if necessary.

Moving the embroidery arm to the left



- > Touch the icon «Embroidery hoop display/Embroidery hoop selection».
- > Remove the hoop.



- > Touch the icon «Move the embroidery arm to the left».
 - An animation «Remove the embroidery hoop» appears.



- > Touch the icon «Confirm» to bring the embroidery hoop to the left into the parking position.

Grid on/off

When the center of the hoop and the grid are displayed, the embroidery motif can be positioned more exactly.



- > Touch the icon «Embroidery hoop display/Embroidery hoop selection».

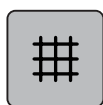

- > Touch the icon «Grid on/off» to display the center of the hoop on the display.
- > Touch the icon «Grid on/off» again to display the grid.
- > Touch the icon «Grid on/off» again so that the center of the hoop and the grid disappear.

Locating the center of the embroidery motif

The embroidery hoop is positioned so that the needle is exactly above the center of the embroidery motif or the motif begin.



- > Touch the icon «Embroidery hoop display/Embroidery hoop selection».



- > Touch the icon «Center of embroidery motif» or



- > push the button «Center of embroidery motif» to position the embroidery hoop so that the needle is exactly above the center of the embroidery motif.
- > Touch the icon «Center of embroidery motif» again or
- > push the button «Center of embroidery motif» again to position the embroidery hoop so that the needle is exactly above the pattern begin.

Virtual positioning of the embroidery hoop

The embroidery hoop is automatically moved to the new position as soon as the embroidery motif is repositioned. Therefore the icon «Virtual positioning» is activated automatically and outlined in yellow when an embroidery hoop is attached.

Prerequisite:

- The hoop is attached.



- > Touch the icon «Embroidery hoop display/Embroidery hoop selection».



- > Touch the icon «Virtual positioning» to deactivate the automatic movement of the hoop when having repositioned the embroidery motif.
- > Touch the icon «Virtual positioning» again to activate the automatic movement of the hoop when having repositioned the embroidery motif.

3 Setup Program

3.1 Embroidery settings

Adjusting the upper thread tension

Alterations of the upper thread tension in the Setup Program affect all embroidery motifs. The settings in the Setup Program remain active even after switching the machine off.



- > Touch the icon «Setup Program».



- > Touch the icon «Embroidery settings».



- > Touch the icon «Adjust the upper thread tension».
- > Move the slide using the touchscreen pen/finger or touch the icons «+» or «-» to alter the upper thread tension.
- > Touch the yellow-framed icon to reset the alterations to basic setting.

Adjusting the maximum embroidering speed

By using this function, the maximum speed can be reduced.



- > Touch the icon «Setup Program».



- > Touch the icon «Embroidery settings».



- > Touch the icon «Alter the maximum speed».
- > Move the slide using the touchscreen pen/finger or touch the icons «+» or «-» to alter the maximum speed.
- > Touch the yellow-framed icon to reset the alterations to basic setting.

Centering the embroidery motif

When the embroidery motif is opened on the machine, it is always centered to the embroidery hoop. If you want the embroidery motif to be opened in its original position (defined by the BERNINA embroidery software), the function «Center the embroidery motif» must be activated.



- > Touch the icon «Setup Program».



- > Touch the icon «Embroidery settings».



- > Touch the icon «Center the embroidery motif».



- > Press the switch in the right section.
 - A previously moved embroidery motif which has been saved in the new position is opened in the saved position after selecting.

- > Press the switch in the right section again.
 - The embroidery motif is centered to the embroidery hoop.

Calibrating the embroidery hoop

The calibration of the embroidery hoop is the coordination of the needle to the center of the embroidery hoop.

Prerequisite:

- The embroidery module is connected and the embroidery hoop with the appropriate embroidery template is attached.



- > Touch the icon «Setup Program».



- > Touch the icon «Embroidery settings».



- > Touch the icon «Calibrate the embroidery hoop».
- > Select the desired embroidery hoop and follow the instructions in the display.
- > Touch the icon «Delete» (1) to delete the present calibration.
- > Center the needle via the arrow icons on the display.



Entering the fabric thickness

If the fabric thickness is more than 4 mm as for e.g. toweling, it is recommended to select 7.5 mm or 10 mm. The thicker the fabric, the slower the embroidery speed of the machine. When the machine is switched off, the alterations are reset to the basic setting 4 mm.



- > Touch the icon «Setup Program».



- > Touch the icon «Embroidery settings».



- > Touch the icon «Select the fabric thickness».
- > Select fabric thickness.

Programming securing stitches (Smart Secure)

Embroidery motifs are programmed either with or without securing stitches. The machine recognizes when no securing stitches are programmed and adds some.



> Touch the icon «Setup Program».



> Touch the icon «Embroidery settings».



> Touch the icon «Securing stitches on/off».



- > Press the switch in the upper right section to deactivate the securing stitches at the start.
 - If the embroidery motif has programmed securing stitches, they will be embroidered.
 - If the embroidery motif doesn't have any programmed securing stitches, there won't be any embroidered.
- > Press the switch again to activate the securing stitches at the start.
 - If the embroidery motif has programmed securing stitches, they will be embroidered.
 - If the embroidery motif doesn't have any programmed securing stitches, the securing stitches are added and will be embroidered.
- > Press the switch in the lower right section to deactivate the securing stitches at the end.
 - If the embroidery motif has programmed securing stitches, they will be embroidered.
 - If the embroidery motif doesn't have programmed securing stitches, there won't be any embroidered.
- > Press the switch again to activate the securing stitches at the end.
 - If the embroidery motif has programmed securing stitches, they will be embroidered.
 - If the embroidery motif doesn't have any programmed securing stitches, the securing stitches are added and will be embroidered.

Adjusting the thread cut



> Touch the icon «Setup Program».



> Touch the icon «Embroidery settings».



> Touch the icon «Thread cut settings».



- > Touch the switch in the upper section of the display (1) to deactivate the automatic thread cut after a color change.
- > Touch the switch in the upper section of the display (1) again to activate the automatic thread cut after a color change.
- > Touch the switch in the middle section of the display (2) so that the machine will stop after about 7 stitches and the remaining thread can be cut manually.
- > Touch the switch in the middle section of the display (2) again and the machine won't stop for a manual thread cut.

> Touch the icons «-» or «+» (3) to adjust the length from where the connecting stitches are cut.

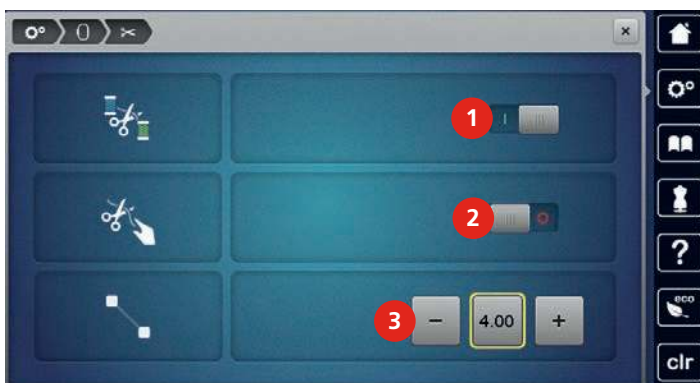

> Touch the yellow-framed icon to reset the alterations to basic setting.

3.2 Selecting personal settings



> Touch the icon «Setup Program».



- > Touch the icon «Personal settings».
- > Select the desired color of the display and the background.
- > Touch the text box above the color settings.

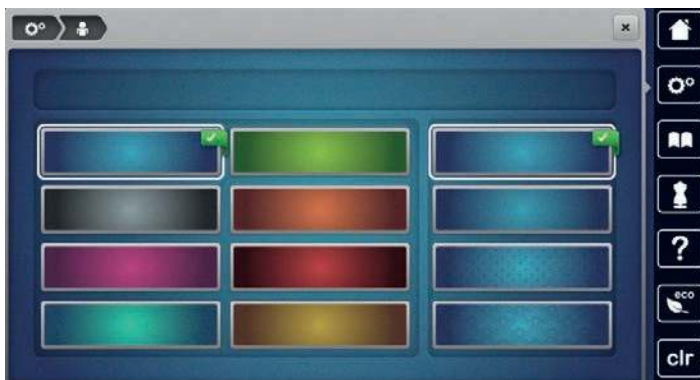

- > Enter the welcome text.
- > Touch the icon «ABC» (standard setting) to use upper-case letters.
- > Touch the icon «abc» to use lower-case letters.
- > Touch the icon «123» to use figures and mathematical symbols.
- > Touch the icon «@&!» to use special characters.
- > Touch the text box above the keyboard to delete the entered text completely.
- > Touch the icon «DEL» to delete individual syllables of the entered text.



> Touch the icon «Confirm».



3.3 Monitoring functions

Activating the upper thread indicator



> Touch the icon «Setup Program».



- > Touch the icon «Monitoring settings».



- > Touch the switch in the upper section of the display to deactivate the upper thread indicator.
- > Touch the switch again to activate the upper thread indicator.

Activating the bobbin thread indicator



- > Touch the icon «Setup Program».



- > Touch the icon «Monitoring settings».



- > Touch the switch in the lower section of the display to deactivate the bobbin thread indicator.
- > Touch the switch again to activate the bobbin thread indicator.

3.4 Activating the audio signals



- > Touch the icon «Setup Program».



- > Touch the icon «Audio signals».
- > Touch the switch (1) to deactivate any audio signals in general.
- > Touch the switch (1) again to activate any audio signals in general.
- > Touch the icons «1 – 4» in the section (2) to set up the desired signal for the selection of a embroidery motif.



- > Touch the icon «Loudspeaker» in the section (2) to deactivate the signal for the selection of a embroidery motif.



- > Touch the icon «Loudspeaker» again to activate the signal for the selection of a embroidery motif.
- > In the section (3) touch the icons «1 – 4» to activate the signal for the selection of functions.
- > In the section (3) touch the icon «Loudspeaker» to deactivate the signal for the selection of functions.
- > In the section (3) touch the icon «Loudspeaker» again to activate the signal for the selection of functions.

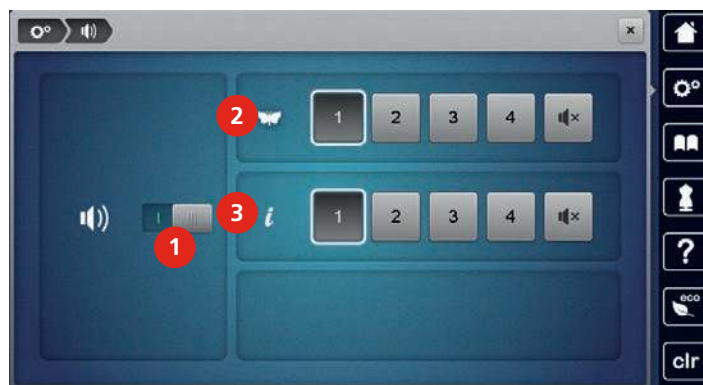

3.5 Machine settings

Selecting a language

The User Interface can be programmed in different languages according to the customer's wish because BERNINA provides a wide range of international languages for the customers. Via firmware updates additional languages for the User Interface can be provided.



> Touch the icon «Setup Program».



> Touch the icon «Machine settings».



> Touch the icon «Language selection».
> Select a language.

Adjusting the brightness of the display

The brightness of the display can be adjusted corresponding to the personal preferences.



> Touch the icon «Setup Program».



> Touch the icon «Machine settings».



> Touch the icon «Adjust the brightness».
> Move the slide in the upper portion of the display using the touchscreen pen/finger or touch the icons «+» or «-» to alter the brightness of the display.

Adjusting the sewing light

The brightness of the sewing light can be adjusted corresponding to the personal preferences.



> Touch the icon «Setup Program».



> Touch the icon «Machine settings».



> Touch the icon «Adjust the brightness».
> Move the slide in the upper portion of the display using the touchscreen pen/finger or touch the icons «+» or «-» to alter the brightness of the sewing light.



> Touch the switch to switch the sewing light off.
> Touch the switch again to switch the sewing light on.

Calibrating the display

Please find further information on this topic in the chapter attachment below troubleshooting at the end of the instruction manual.



> Touch the icon «Setup Program».



> Touch the icon «Machine settings».



> Touch the icon «Calibrate the display».
> Touch the crosses in sequence using the touchscreen pen.

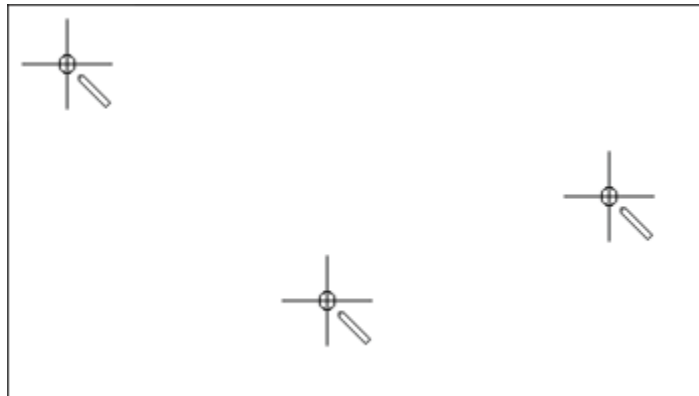

Back to basic setting

ATTENTION: Using this function will delete all individually made settings.



> Touch the icon «Setup Program».



> Touch the icon «Machine settings».



> Touch the icon «Basic settings».



> Touch the icon «Basic setting Embroidering».



> Touch the icon «Confirm» to restore basic settings for the embroidery settings.

Deleting user data

Motifs which are not needed anymore can be deleted so that there will be more capacity for new motifs.



> Touch the icon «Setup Program».



> Touch the icon «Machine settings».

Setup Program



> Touch the icon «Basic settings».



> Touch the icon «Delete personal embroidery motifs».



> Touch the icon «Confirm» to delete all embroidery motifs from the personal memory.

Deleting motifs on the BERNINA USB Stick

When motifs which won't be needed anymore are saved on the BERNINA USB Stick (Optional accessory), the stick can be connected to the machine and the data can be deleted.

> Insert the BERNINA USB Stick (Optional accessory) into the den USB port of the machine.

> Touch the icon «Setup Program».



> Touch the icon «Machine settings».



> Touch the icon «Basic settings».



> Touch the icon «Delete data from USB Stick».



> Touch the icon «Confirm» to delete all data on the BERNINA USB Stick (Optional accessory).



Updating the machine Firmware

NOTICE

BERNINA USB stick (Optional accessory) has been removed too early

Firmware has not been updated and the machine cannot be used.

> Remove the BERNINA USB stick (Optional accessory) only after the update has been completed successfully.

The latest firmware of the machine and a detailed step-by-step instruction for updating processes can be downloaded at www.bernina.com. In general, personal data and settings are automatically transferred during a firmware update. For reasons of safety, it is also recommended to save data and settings on a BERNINA USB stick (Optional accessory) before the firmware update is started. If personal data and settings should get lost during a firmware update, they can be transferred to the machine again afterwards.

> Insert the BERNINA USB Stick (Optional accessory), FAT32 formatted, providing the latest software version into the port.

> Touch the icon «Setup Program».



> Touch the icon «Machine settings».



> Touch the icon «Maintenance/Update».





> Touch the icon «Updating the machine».



> Touch the icon «Save data on USB stick».
– The icon is tagged with a green check mark.



> Touch the icon «Update» to start the update of the software.

Recovering saved data

NOTICE

BERNINA USB stick (Optional accessory) has been removed too early

Saved data cannot be transferred and the machine cannot be used.

> Remove the BERNINA USB stick (Optional accessory) only after the saved data has been transferred successfully.

If personal data and settings after a software update are not available anymore, they can be transferred to the machine again afterwards.

> Insert the BERNINA USB stick (Optional accessory) providing the saved data and settings into the USB port of the machine.

> Touch the icon «Setup Program».



> Touch the icon «Machine settings».



> Touch the icon «Maintenance/Update».



> Touch the icon «Updating the machine».



> Touch the icon «Transfer saved data to machine».
– The icon is tagged with a green check mark.



Cleaning the thread catcher

In chapter «Maintenance and cleaning» there are additional illustrated step-by-step instructions.

> Touch the icon «Setup Program».



> Touch the icon «Machine settings».



> Touch the icon «Maintenance/Update».



Setup Program



- > Touch the icon «Clean the thread catcher».
- > Clean the thread catcher according to the instructions on the display.

Lubricating the machine



Electronically driven components

Risk of injury near the needle and the hook.

- > Switch the machine off and disconnect it from the power supply system.



Lubricating the hook

Too much oil can result in staining the fabric or the thread.

- > Give one drop of BERNINA oil in each of the two oil depots. Sew/Embroider on a test piece first.

The Setup Program provides animations how the machine has to be oiled. In chapter «Maintenance and cleaning» there are more illustrated step by step instructions (see page 91). Use BERNINA oil to lubricate.



- > Touch the icon «Setup Program».



- > Touch the icon «Machine settings».



- > Touch the icon «Maintenance/Update».



- > Touch the icon «Lubricate the machine».
- > Lubricate the machine according to the instructions on the display.

Packing the embroidery module

To pack the embroidery module into the original packaging without moving the embroidery arm manually, the embroidery arm needs to be brought to its packing position.

Prerequisite:

- The embroidery module is connected with the machine.



- > Touch the icon «Setup Program».



- > Touch the icon «Machine settings».



- > Touch the icon «Maintenance/Update».



- > Touch the icon «Pack position for the embroidery module».
- > Follow the instructions on the display.

Checking the firmware version

Both the firmware and the hardware version of the machine and the attached embroidery module are displayed.



> Touch the icon «Setup Program».



> Touch the icon «Machine settings».



> Touch the icon «Information».



> Touch the icon «Firmware and hardware information».

Reviewing the total number of stitches

The total number of stitches of the machine as well as the number of stitches since the last service carried out by the specialized BERNINA dealer are displayed.



> Touch the icon «Setup Program».



> Touch the icon «Machine settings».



> Touch the icon «Information».



> Touch the icon «Firmware und Hardware Informationen».

Registering details of the dealer

The contact details of your specialized BERNINA dealer can be registered.



> Touch the icon «Setup Program».



> Touch the icon «Machine settings».



> Touch the icon «Information».



> Touch the icon «Dealer details» to enter the information of the specialized dealer.



> Touch the icon «Name of the shop» to enter the name of the specialized BERNINA dealer.



> Touch the icon «Address» to enter the address of the specialized BERNINA dealer.



> Touch the icon «Phone» to enter the telephone number of the specialized BERNINA dealer.



> Touch the icon «Internet» to enter the Internet homepage or the email address of the specialized BERNINA dealer.

Saving Service data

Service data concerning the status quo of the machine can be saved on a BERNINA USB stick (Optional accessory) and then given to the BERNINA dealer this way.

> Insert a BERNINA USB stick (Optional accessory) which provides enough free memory space into the USB port.



> Touch the icon «Setup Program».



> Touch the icon «Machine settings».



> Touch the icon «Information».



> Touch the icon «Service data».

> Touch the icon «LOG».

– The icon «LOG» is outlined in white.

> Only when the icon is not outlined in white anymore, remove the BERNINA USB Stick (Optional accessory).

5 Creative embroidering

5.1 Overview embroidering

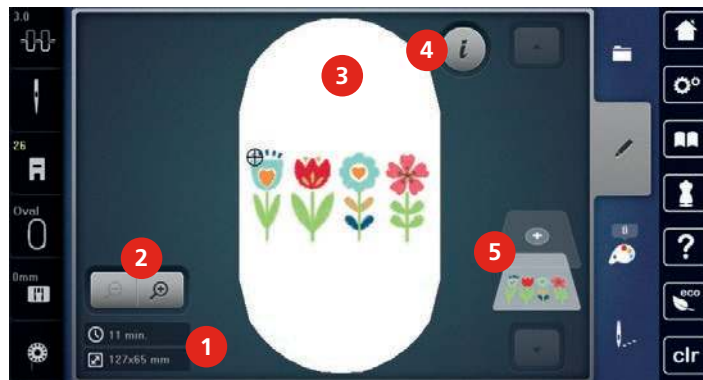

- | | | | |
|---|---|---|-------------------------|
| 1 | Embroidery time/Embroidery motif size in mm | 4 | «i»-Dialog |
| 2 | Scaling up, downsizing and moving the embroidery motif view | 5 | Embroidery motif layers |
| 3 | Area to be embroidered | | |

5.2 Selecting and changing the embroidery motif



- > Touch the icon «Selection».



- > Touch the icon «Load embroidery motif».
- > Select a new embroidery motif.

5.3 Checking the embroidery time and the embroidery motif size

In the selection menu «Editing» the estimated embroidery time in minutes as well as the width and height of the embroidery motif is indicated at lower left (1).

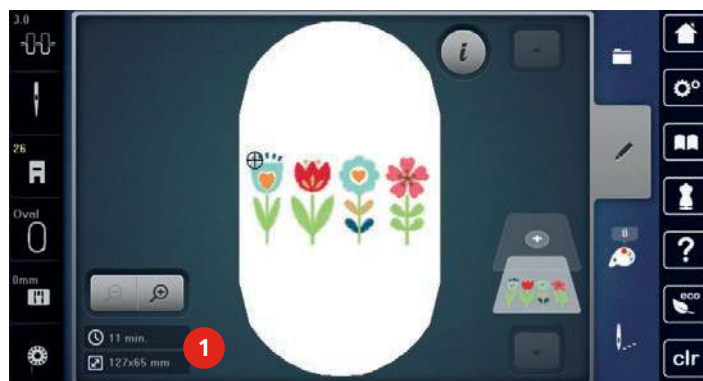

5.4 Regulating the speed

The speed is infinitely variable with the slide-speed control.

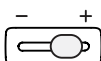

- > Move the slide-speed control to the left to reduce the speed.
- > Move the slide-speed control to the right to increase the speed.

5.5 Editing the embroidery motif

Overview Editing embroidery motif



- | | | | |
|---|-------------------------------|----|---|
| 1 | Moving the view | 9 | Mirror image left/right |
| 2 | Moving the motif | 10 | Mirror image up/down |
| 3 | Zoom out | 11 | Bending text |
| 4 | Zoom in | 12 | Altering the stitch type/stitch density |
| 5 | Moving the motif | 13 | Checking the motif size |
| 6 | Rotating the embroidery motif | 14 | Endless Embroidery |
| 7 | Altering the size | 15 | Duplicating |
| 8 | Pinpoint placement | 16 | Deleting |

Scaling up the embroidery motif view

The view of the embroidery motif can be scaled up. In addition to that, the view can be adjusted with or without changing the embroidery position.

- > Select the embroidery motif.
- > Touch the icon «Zoom in» to edit the view of the embroidery motif.
- > Touch the icon «Zoom in» 1 – 4 times to scale up the view of the embroidery motif gradually.
- > Touch the icon «Zoom out» 1 – 4 times to get back to the Edit Mode.



Downsizing the embroidery motif

The view of the embroidery motif can be downsized. In addition to that, the view can be adjusted with or without changing the embroidery position.

- > Select the embroidery motif.
- > Touch the icon «Zoom in» to scale up the embroidery motif.
- > Touch the icon «Zoom out» 1 – 4 times to minimize the view of the embroidery motif gradually.



Moving the embroidery motif view

The view of the embroidery motif can be moved. In addition to that, the view can be adjusted with or without changing the embroidery position.

- > Select the embroidery motif.
- > Touch the icon «Zoom in» to activate the icon «Move the view».
-  > Touch the icon «Move the view».
 - The icon turns dark gray.
- > Alter the view of the embroidery motif using the touchscreen pen or the finger.
 - The embroidery position is not altered.
-  > Touch the icon «Zoom out» to go back to the Edit Mode.

Moving the embroidery motif in enlarged view

The view of the embroidery motif can be moved. In addition to that, the view can be adjusted with or without changing the embroidery position.

- > Select the embroidery motif.
- > Touch the icon «Zoom in» to activate the icon «Move the motif».
-  > Touch the icon «Move the motif».
-  > Move the view of the embroidery motif using the touchscreen pen or the finger.
 - The embroidery position is altered.
- > Touch the icon «Zoom out» to go back to the Edit Mode.
- 

Moving the embroidery motif

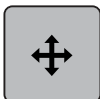
- > Select the embroidery motif.
- > Touch the icon «i» Dialog.
-  > Touch the icon «Move the motif».
-  > Turn the «Upper Multifunctional knob» to move the embroidery motif horizontally in 1/10-mm steps.
- > Turn the «Lower Multifunctional knob» to move the embroidery motif vertically in 1/10-mm steps or
- > touch the embroidery motif, keep it pressed and move it as you like.
 - The relocation is indicated in the yellow-framed icons.

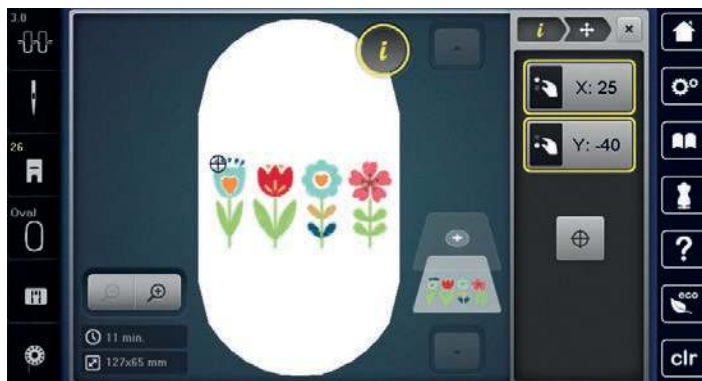

-  > Touch the icon «Center of the embroidery motif».
 - The embroidery hoop is moved until the needle is exactly positioned in the center of the embroidery motif.

Rotating the embroidery motif

- > Select the embroidery motif.
- > Touch the icon «i»-Dialog.

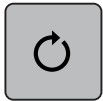

- > Touch the icon «Rotate the embroidery motif».
- > Turn the «Upper Multifunctional knob» or the «Lower Multifunctional knob» to the right to rotate the embroidery motif clockwise.
- > Turn the «Upper Multifunctional knob» or the «Lower Multifunctional knob» to the left to rotate the embroidery motif counter-clockwise.
- > Touch the icon «Rotate the embroidery motif +90°» to rotate the embroidery motif in 90°-steps.



Altering the embroidery motif size proportionally

If the icon «Retain the proportions» is framed in white, the embroidery motif is altered proportionally.

- > Select the embroidery motif.
- > Touch the icon «i»-Dialog.



- > Touch the icon «Alter the embroidery size».
- > Turn the «Upper/Lower Multifunctional knob» to the right to scale up the embroidery motif proportionally.
- > Turn the «Upper/Lower Multifunctional knob» to the left to downsize the embroidery motif proportionally.



Altering the embroidery motif size disproportionally

If the icon «Retain the proportions» is **not** outlined in white, the embroidery motif is altered disproportionally.

- > Select the embroidery motif.
- > Touch the icon «i»-Dialog.



- > Touch the icon «Alter the embroidery motif size» to alter the embroidery motif width and height independent on each other.



- > Touch the icon «Retain the proportions».
- > Turn the «Upper Multifunctional knob» to alter the embroidery motif horizontally.
- > Turn the «Lower Multifunctional knob» to alter the embroidery motif vertically.
 - The embroidery motif is **not** scaled up or downsized proportionally.



Mirroring embroidery motifs

Embroidery motifs can be mirror-imaged both vertically and horizontally.

- > Select the embroidery motif.
- > Touch the icon «i»-Dialog.



- > Touch the icon «Mirror image left/right» to mirror the embroidery motif vertically.



- > Touch the icon «Mirror image up/down» to mirror the embroidery motif horizontally.

Bending text

Texts can be arranged and designed arc-shaped.

- > Create an alphabet embroidery motif
- > Touch the icon «i»-Dialog.



- > Touch the icon «Bend text».
- > Turn the «Upper Multifunctional knob» to alter the distance between the characters in millimeter-steps.
- > Turn the «Lower Multifunctional knob» to the left or to the right to bend the lettering upwards or downwards.

Changing the stitch type

If the satin stitches are too long, they can be changed to step stitches.

- > Select the embroidery motif.
- > Touch the icon «i»-Dialog.





- > Touch the icon «Change the stitch type».
- > Touch the switch in the upper section of the display (1) to change the satin stitch to the step stitch.
- > Adjust the desired stitch length (2) with the icons «-» or «+».



Altering the stitch density

If the satin stitches are embroidered too densely, the stitch density can be adjusted.

- > Select the embroidery motif.
- > Touch the icon «i»-Dialog.



- > Touch the icon «Change the stitch type».
- > Adjust the desired stitch density (1) with the icons «-» or «+».



Checking the embroidery motif size and position

It can be checked whether or not the embroidery motif matches the designated position/location on the fabric. Points which are beyond the embroidery hoop are not traveled to.

- > Select the embroidery motif.
- > Touch the icon «i»-Dialog.

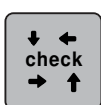

- > Touch the icon «Check the embroidery motif size» or
- > push the button «Check the embroidery motif size».
 - The embroidery hoop travels all the way until the needle is at the position as it is indicated in the display.

- > Touch the icon «Corner top left» to select the top left corner of the embroidery motif.
 - The embroidery hoop travels all the way until the needle is at the position as it is indicated in the display.
- > Touch the icon «Corner top right» to select the top right corner of the embroidery motif.
 - The embroidery hoop travels all the way until the needle is at the position as it is indicated in the display.
- > Touch the icon «Corner bottom left» to select the bottom left corner of the embroidery motif.
 - The embroidery hoop travels all the way until the needle is at the position as it is indicated in the display.
- > Touch the icon «Corner bottom right» to select the bottom right corner of the embroidery motif.
 - The embroidery hoop travels all the way until the needle is at the position as it is indicated in the display. If the embroidery motif hasn't been positioned correctly yet, the position can be altered via the «Upper/Lower Multifunctional knobs» and the complete embroidery positions can be checked again.

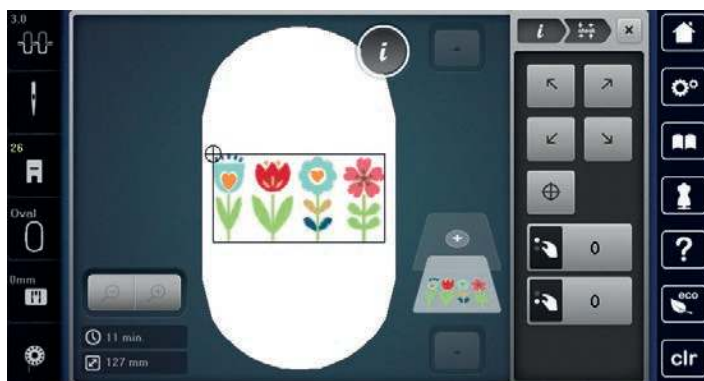

- > Touch the icon «Center of the embroidery motif» or



- > push the button «Center of the embroidery motif» to bring the needle to the center of the embroidery motif.
- > Turn the «Upper Multifunctional knob» to move the embroidery motif horizontally.
- > Turn the «Lower Multifunctional knob» to move the embroidery motif vertically.

Endless embroidery

When embroidering a border, it is advantageous to use the «Mega-Hoop» (Optional accessory) or the «Maxi-Hoop» (Optional accessory). The embroidery project requires less rehooping. We recommend marking reference lines on the fabric, and using the template when hooping and rehooping. Here, the reference lines must run parallel to the lines on the template. In the following example, the supplied «Oval Hoop» is used.

- > Select the embroidery motif.
- > Touch the icon «i»-Dialog.



- > Touch the icon «Endless Embroidery».
 - The embroidery motif will be duplicated as many times as possible to fill the hoop.
 - The reference points, which are necessary when rehooping the fabric, are added.
- > Add further reference points, if necessary, using the arrow icons (1).
- > Turn the «Upper Multifunctional knob» or
- > touch the icons «-/+» (2) to enter the number of embroidery motifs.
- > Turn the «Lower Multifunctional knob» or
- > touch the icons «-/+» (3) to determine the distance between the embroidery motifs.



> Touch the icon «Fit to hoop» (4) to adjust the size of the motifs automatically so they all fit in the hoop.



> Touch the icon «Confirm».

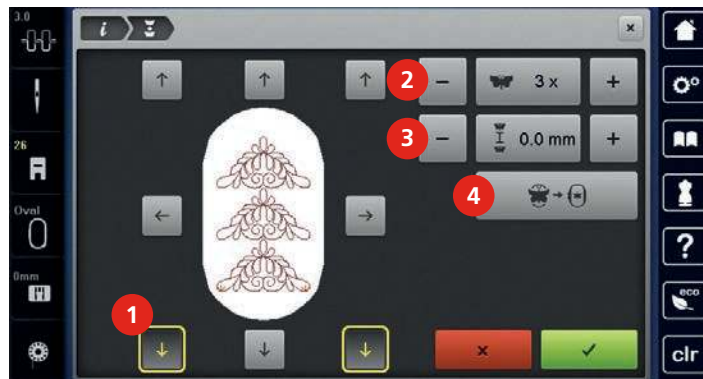

> Touch the icon «i»-Dialog.



> Touch the icon «Embroidering».



> Push the button «Start/Stop» and embroider the border.
– The embroidery motif must be embroidered completely.

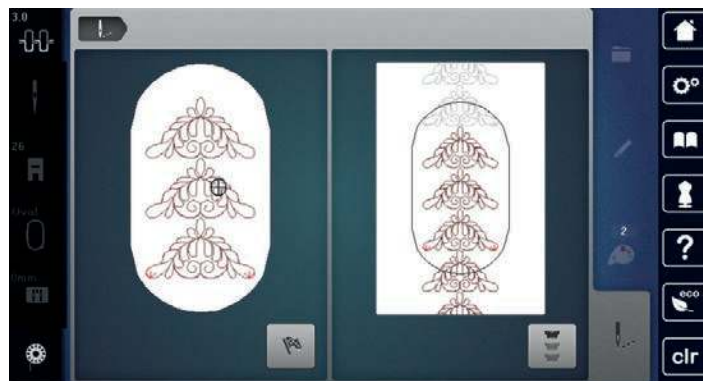

> Touch the icon «Endless Embroidery» when the reference points have been embroidered.
– An animation indicates that the fabric must be rehooped.

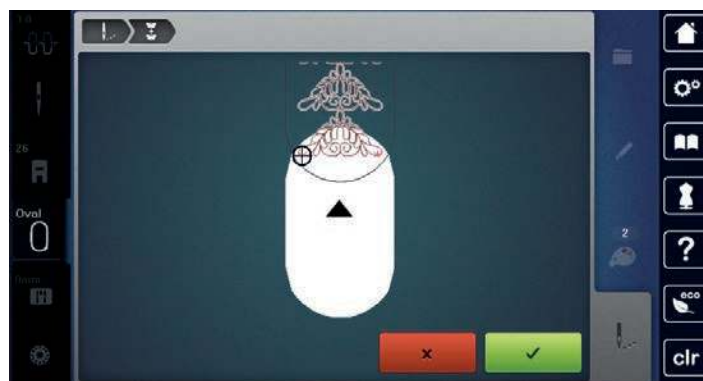

> Remove the hoop and rehoop the fabric so that the stitched out reference points are in the upper part of the area to be embroidered and at least 3 cm from the top edge of the hoop.

> Attach the hoop.



- > Touch the icon «Confirm».
 - The embroidery hoop is moved automatically close to the reference point.
 - The icon «AUTO» is activated and the embroidery hoop moves automatically near the last reference point.
- > Via the arrow icons, determine on which side of the embroidered part the next reference point shall be placed.
- > Turn the «Upper Multifunctional knob» or the «Lower Multifunctional knob» to position the hoop exactly.

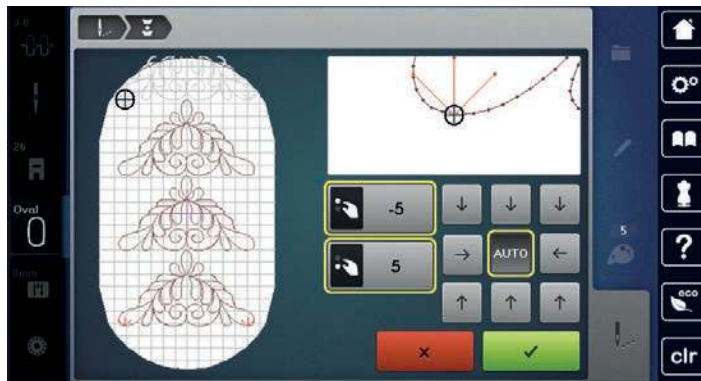

- > Touch the icon «Confirm».



- > Push the button «Start/Stop» and resume embroidering.
- > Repeat these steps until the desired length of the border is embroidered.

Duplicating the embroidery motif

The active embroidery motif is duplicated.

- > Select the embroidery motif.
- > Touch the icon «i»-Dialog.



- > Touch the icon «Duplicate».

Deleting the embroidery motif

The active embroidery motif is deleted.

- > Select the embroidery motif.
- > Touch the icon «i»-Dialog.



- > Touch the icon «Delete».

5.6 Pinpoint placement

Positioning of grid points

This function allows the exact positioning of the embroidery motif on the fabric in an easy way. The positioning points can be placed in the grid.

Prerequisite:

- Any two points of the embroidery motif are marked with chalk or a water-soluble pen on the fabric. The place or the location where the embroidery motif is to be positioned is clearly visible.

- > Select the embroidery motif.
- > Touch the icon «i»-Dialog.



- > Touch the icon «Pinpoint placement».



- > Touch the icon «Grid».

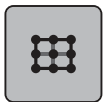

- The embroidery motif is given a grid with nine different location/positioning points.
- > Select the desired positioning point to which the embroidery motif is to be adjusted.
- The point changes its color.

- > Turn the «Upper Multifunctional knob» or the «Lower Multifunctional knob» to the left or to the right to position the needle above the respective mark on the fabric.

- > Touch the icon «SET» to confirm the changed position.
- The point changes its color and is defined.



- > Select the second positioning point of the embroidery motif.

- > Turn the «Upper Multifunctional knob» or the «Lower Multifunctional knob» to the left or to the right to position the needle above the respective mark on the fabric.

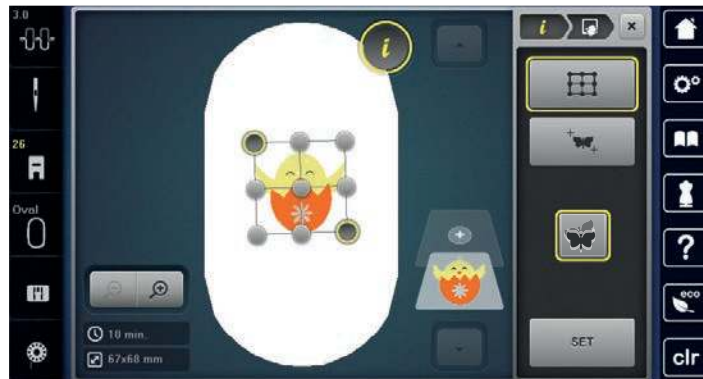

- > Touch the icon «SET» to confirm the changed position.
- The point changes its color and is defined. The embroidery motif is adjusted accordingly.

- > Touch the icon «Reset Pinpoint placement» to reset the alterations to basic setting.



Free point positioning

This function allows exact positioning of embroidery motifs on the fabric in an easy way. The points can be defined as you like within the embroidery motif.

Prerequisite:

- Any two points of the embroidery motif are marked with chalk or a water-soluble pen on the fabric. The place or the location where the embroidery motif is to be positioned is clearly visible.

- > Select the embroidery motif.
- > Touch the icon «i»-Dialog.



- > Touch the icon «Pinpoint placement».



- > Touch the icon «Place points as desired».
- > Define a desired point within the embroidery motif.
 - The positioning point is displayed.



- > Turn the «Upper Multifunctional knob» or the «Lower Multifunctional knob» to the left or to the right to position the needle above the respective mark on the fabric.

- > Touch the icon «SET» to confirm the altered position.
 - The point changes its color and is defined.



- > Select the second positioning point of the embroidery motif.
- > Turn the «Upper Multifunctional knob» or the «Lower Multifunctional knob» to the left or to the right to position the needle above the respective mark on the fabric.



- > Touch the icon «SET» again to confirm the altered position.
 - The point changes its color and is defined. The embroidery motif is adjusted accordingly.

- > Touch the icon «Reset Pinpoint placement» to reset the alterations to basic setting.



5.7 Combining embroidery motifs

Combining embroidery motifs

In the Combi-Mode several embroidery motifs can be combined.

- > Select the embroidery motif.
- > Touch the icon «Add an embroidery motif» (1).



> Select another embroidery motif



> or
> touch the icon «Selection».



> Touch the icon «Add an embroidery motif».
> Select another embroidery motif.

Deleting a single embroidery motif

Prerequisite:

- A combination of embroidery motifs has been created.
- > In the section of the embroidery motif level (1) touch the desired embroidery motif with the finger, keep it pressed and move it outwards.
- A new window opens.



> Touch the icon «Confirm» to delete the selected embroidery motif.

Duplicating the embroidery motif

- > Select the embroidery motif.
- > Touch the icon «i»-Dialog.



- > Touch the icon «Duplicate».
- The embroidery motif (1) is duplicated (2).



Duplicating a combination

When a combination is duplicated, the individual embroidery motifs cannot be selected anymore.

- > Select the embroidery motif.
- > Touch the icon «Add an embroidery motif».
- > Select another embroidery motif.
- > Select the combination (1).
- > Touch the icon «i»-Dialog.







- > Touch the icon «Duplicate».
- The combination is duplicated (2).



5.8 Creating lettering

Overview embroidery alphabets

Embroidery motif		Name
ABC	A B C	Drifter
ABC	A B C	Childs Play
ABC		Victoria
ABC		Condensed Sans
ABC		Flare Serif
ABC		Deco block
<i>ABC</i>		Curly
ABC		Rounded Sans
<i>ABC</i>	<i>A B C</i>	Anniversary
ABC		Bamboo
<i>ABC</i>		Lisa
<i>ABC</i>		Zürich
ABC	A B C	Swiss Block
ABC		Quilt Block

Embroidery motif		Name
		Old English
 		Russian Textbook
		Happy Times
		Chicago

Creating words/sentences



Lettering is always embroidered in one color. To embroider single letters or single words in another color, every letter or every word has to be selected individually and placed in the area to be embroidered.

Lettering can be positioned within the hoop as you like. When the embroidery motif is positioned outside the area to be embroidered, the hoop is outlined in red on the display. With the hoop selection it can be checked whether or not the embroidery motif can be embroidered in another hoop. When the lettering does not fit in any hoop, two single words can be combined and positioned below each other as the following example will show.



- > Select the file «Alphabets».
- > Select the font.
- > Enter the text «Made to».
- > Touch the icon (1) (standard setting) to use upper case letters.
- > Touch the icon (2) to use lower case letters.
- > Touch the icon (3) to use numbers and mathematic characters.
- > Touch the icon (4) to use special characters.



> Touch the icon «DEL» to delete single letters of the entered text.



> Touch the icon «Confirm» to accept the text.



> Touch the icon «Embroidery hoop display/Embroidery hoop selection».

> Select the hoop.

> Touch the icon «Embroidery hoop display/Embroidery hoop selection» again to go back to the Edit Mode.

Editing words/sentences

> Touch the icon «i»-Dialog.



> Touch the icon «Rotate the embroidery motif».

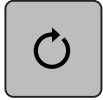

> Touch the icon «+90°» to rotate the text by 90°.



> Touch the icon «i» (1).

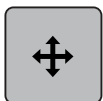

> Touch the icon «Move motif».

> Turn the «Upper Multifunctional knob» to move the embroidery motif horizontally.

> Turn the «Lower Multifunctional knob» to move the embroidery motif vertically.

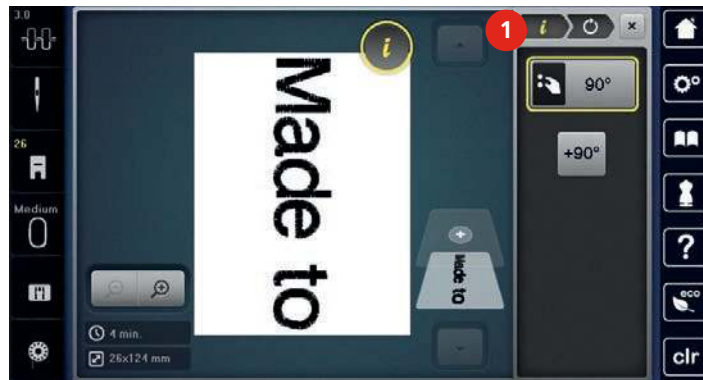

> Touch the icon «Add an embroidery motif».



> Enter and also rotate the text «create».

> Touch the icon «Embroidery hoop display/Embroidery hoop selection».



> Touch the icon «Grid on/off» to position the text lines more exactly.

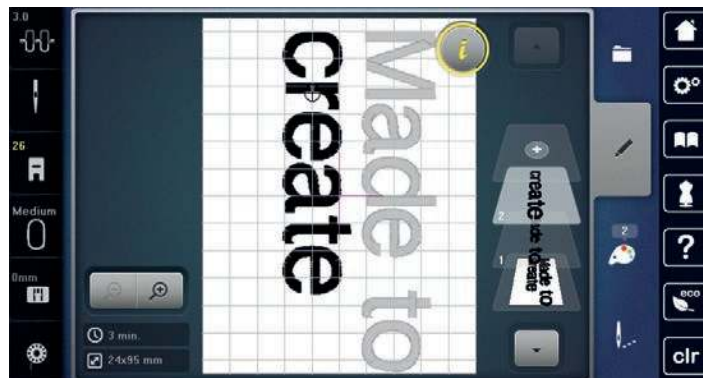
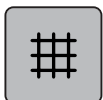

5.9 Changing the colors of the embroidery motif

Overview changing the color



- | | | | |
|---|-----------------------------|---|----------------------|
| 1 | Colors of embroidery motifs | 4 | Altering color/brand |
| 2 | Preview for selected color | 5 | Color information |
| 3 | Allocating thread brand | | |

Changing the colors



Lettering is always embroidered in one color. To embroider single letters or single words in another color, every letter or every word has to be selected individually and placed in the area to be embroidered.



- > Select the embroidery motif.
- > Touch the icon «Color information».



- > Touch the icon «Alter color/brand» next to the color which is to be changed.



- > Touch the icon «Scroll right» in the lower section of the display to display other colors.



- > Touch the icon «Color selection by number» to select the color by entering the color number.
- > Select the desired color.

Changing the thread brand



- > Select the embroidery motif.
- > Touch the icon «Color information».



- > Touch the icon «Alter color/brand».



- > Touch the icon «Scroll top right» to display other thread brands.



- > Touch the icon «Allocate thread brand».
 - Any thread colors of the selected embroidery motif will be matched with the selected thread brand.

5.10 Embroidering the embroidery motif

Overview Embroidery menu

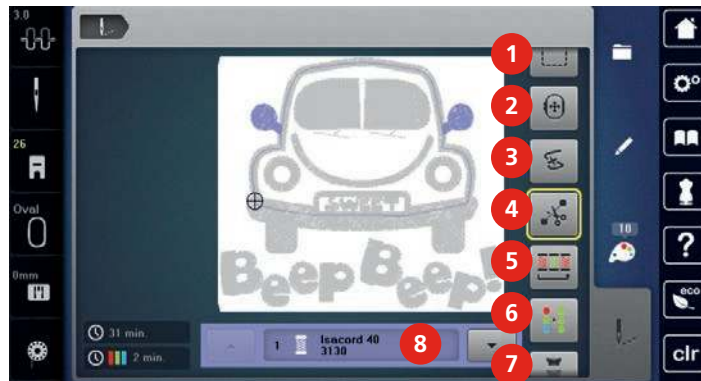

- | | | | |
|---|--|---|---------------------------------------|
| 1 | Basting | 5 | Reducing color changes |
| 2 | Moving the hoop | 6 | Multi-colored embroidery motif on/off |
| 3 | Embroidery sequence control when the thread breaks | 7 | Endless Embroidery |
| 4 | Cutting connecting stitches | 8 | Color indication |

Adding basting stitches

The basting stitches can be embroidered along the embroidery hoop or along the embroidery motif. Therefore the connection between the fabric and the stabilizer can be improved.

- > Select the embroidery motif.
- > Touch the icon «Embroidering».



- > Touch the icon «Basting» to embroider basting stitches along the embroidery motif.
- > Touch the icon «Basting» again to embroider basting stitches along the embroidery hoop.
- > Touch the icon «Basting» again to deactivate the basting stitches.

Moving the hoop

If the embroidery motif is so big that repeated rehooping is necessary, the embroidered motif can be moved again.

- > Select the embroidery motif.
- > Touch the icon «Embroidering».



- > Touch the icon «Move the hoop».
- > Turn the «Upper Multifunctional knob» to move the hoop horizontally.
- > Turn the «Lower Multifunctional knob» to move the hoop vertically.

Embroidery sequence control when thread breaks

When the thread breaks, the needle can be repositioned in the embroidery motif by means of the embroidery sequence control.

- > Select the embroidery motif.
- > Touch the icon «Embroidering».



- > Touch the icon «Embroidery sequence control when thread breaks».
 - In the left section of the display a compact view of the embroidery motif is displayed. On the right side the enlarged embroidery motif is displayed.



- > Select the desired position in the compact view using the touchscreen pen or the finger.
- > Turn the «Upper Multifunctional knob» to move the hoop stitch by stitch.
- > Turn the «Lower Multifunctional knob» to move the hoop in large steps.
- > Touch the icon «0-9» to select the desired stitch by entry.



Cutting connecting stitches

The function is activated by default and the connecting stitches are cut automatically. When the function is deactivated, the connecting stitches between the embroidery motifs must be cut manually.

- > Select the embroidery motif.
- > Touch the icon «Embroidering».



- > Touch the yellow-framed icon «Cutting connecting stitches» to deactivate the function.



Reducing color changes

When the embroidery motifs overlap, the color changes **cannot** be reduced.

- > Select the embroidery motif.
- > Touch the icon «Embroidering».



- > Touch the icon «Reduce color changes».
 - Identical colors of the embroidery motif are collected to one color.



Multi-colored embroidery motif on/off

Multi-colored embroidery motifs can also be embroidered in one color.

- > Select the embroidery motif.
- > Touch the icon «Embroidering».



- > Touch the icon «Multi-colored embroidery motif on/off».
 - The embroidery motif is embroidered in one color.

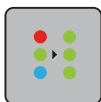

Endless Embroidery

Allows to resume embroidering borders which have already been started even if the machine has been switched off and on again.

Prerequisite:

- An embroidery motif for borders must be saved in the Personal Memory. The reference points must be defined in the embroidery motif.
- > Select border embroidery motif from the Personal Memory.
- > Touch the icon «Embroidering».



- > The icon «Endless embroidery» becomes visible in the right bar by scrolling upwards.
- > Touch the icon «Endless Embroidery».

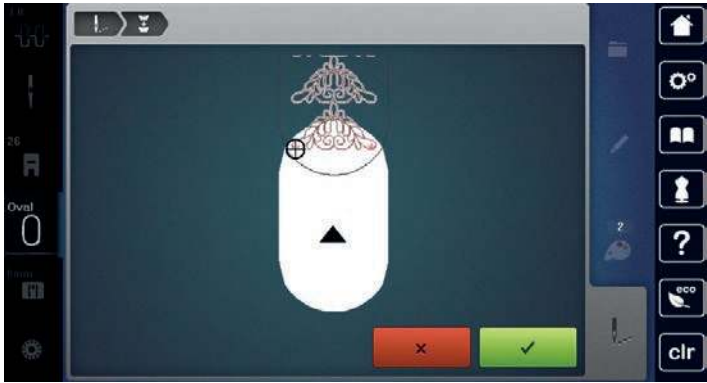

- > Remove the hoop and rehoop the fabric so that the stitched out reference points are in the upper part of the area to be embroidered and at least 3 cm from the top edge of the hoop.
- > Attach the hoop.



- > Touch the icon «Confirm».
 - The hoop is moved automatically near the last stitch.
 - The icon «AUTO» is activated and the hoop moves automatically near the last reference point.
- > Via the arrow icons, determine on which side of the embroidered part the next reference point shall be placed.
- > Turn the «Upper Multifunctional knob» or the «Lower Multifunctional knob» to position the hoop exactly.

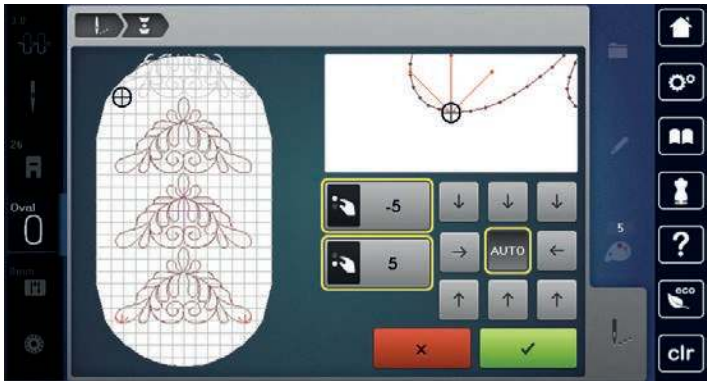

- > Touch the icon «Confirm».



- > Push the button «Start/Stop» and resume embroidering.
- > Repeat these steps until the desired length of the border is embroidered.

Color indication

Every color of the embroidery motif can be selected individually. The hoop moves to the first stitch of the current color. The currently active color can be embroidered individually or in another sequence.

- > Select the embroidery motif.
- > Touch the icon «Embroidering».



- > Touch the icon «Scroll down» to select the next color of the embroidery motif.
- > Touch the icon «Scroll up» to select the previous color of the embroidery motif.

5.11 Administering embroidery motifs

Administering embroidery motifs

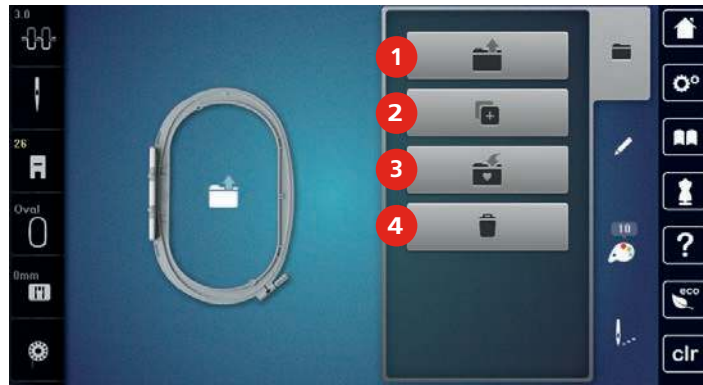

- | | | | |
|---|------------------------------|---|-----------------------------|
| 1 | Loading the embroidery motif | 3 | Saving the embroidery motif |
| 2 | Adding an embroidery motif | 4 | Deleting |

Saving embroidery motifs in the personal memory

- > Edit the embroidery motif.
- > Touch the icon «Selection».



- > Touch the icon «Saving the embroidery motif».
 - The embroidery motif to be saved is outlined in yellow.
 - The icon «Embroidery machine» is activated.

- > Touch the icon «Confirm».

Saving the embroidery motif on the BERNINA USB stick

- > Edit the embroidery motif.
- > Touch the icon «Selection».



- > Touch the icon «Saving the embroidery motif».
 - The embroidery motif to be saved is outlined in yellow.

- > Insert the BERNINA USB stick into the USB port of the machine.
- > Touch the icon «USB stick».
- > Touch the icon «Confirm».

Overwriting the embroidery motif in the personal memory

- > Edit the embroidery motif.
- > Touch the icon «Selection».
- > Touch the icon «Saving the embroidery motif».
 - The embroidery motif to be saved is outlined in yellow.
 - The icon «Embroidery machine» is activated.
- > Select the embroidery motif which is to be overwritten.
- > Touch the icon «Confirm».

Overwriting the embroidery motif on the BERNINA USB stick

- > Edit the embroidery motif.
- > Touch the icon «Selection».
- > Touch the icon «Save the embroidery motif».
 - The embroidery motif to be saved is outlined in yellow.
- > Insert the BERNINA USB stick into the USB port of the machine.
- > Touch the icon «USB stick».
- > Select the embroidery motif which is to be overwritten.
- > Touch the icon «Confirm».

Loading an embroidery motif from the personal memory

- > Touch the icon «Selection».
- > Touch the icon «Load embroidery motif».
- > Select the file «Personal embroidery motifs».
- > Select the embroidery motif.

Loading an embroidery motif from the BERNINA USB stick

- > Touch the icon «Selection».
- > Insert the BERNINA USB stick into the USB port of the machine.
- > Touch the icon «USB stick».
- > Select a personal embroidery motif.

Deleting an embroidery motif from the personal memory

The embroidery motifs which are saved in the personal memory can be deleted individually. In the Setup Program all embroidery motifs from the personal memory can be deleted (see page 59).



> Touch the icon «Selection».



> Touch the icon «Delete».



– The icon «Embroidery machine» is activated.



> Select the embroidery motif which is to be deleted.



> Touch the icon «Confirm».

Deleting an embroidery motif from the BERNINA USB stick



> Touch the icon «Selection».



> Touch the icon «Delete».

> Insert the BERNINA USB stick into the USB port of the machine.



> Touch the icon «USB stick».

> Select the embroidery motif which is to be deleted.



> Touch the icon «Confirm».

6 Embroidery

6.1 Embroidering via the button «Start/Stop»

In case of a power cut the embroidery process is interrupted. After the restart the machine goes to the position which was embroidered last.



- > Push the button «Start/Stop» to start the embroidery machine.
 - All parts of the motif being in the current color are embroidered.
 - The embroidery machine stops automatically at the end.
 - Both threads are cut automatically.
 - The embroidery machine switches to the next color automatically.



- > Change the upper thread.
- > Push the button «Start/Stop» to embroider the new color.
- > After having completed the embroidery motif, finish the embroidery process by touching the icon «Finish the embroidering process» (1), or touch the icon «Endless embroidery» (2) (see page 72) to embroider the embroidery motif again as border.

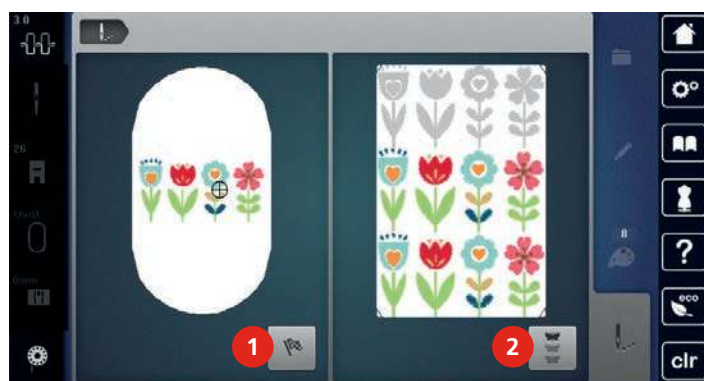

6.2 Increasing the embroidery speed

To ensure the best embroidery quality, the speed when embroidering is reduced depending on the embroidery position. Choose between the two options to either embroider at optimal or maximum speed. Standard = optimal speed. It has to be considered that the quality of the embroidered embroidery motif at maximum speed cannot be ensured.

By switching the machine off and on, the optimal embroidery speed is activated.

Prerequisite:

- The embroidery motif has been selected and the embroidering has started.



- > Touch the icon «Embroidery speed».
 - The maximum speed is activated.
- > Touch the icon «Embroidery speed» again.
 - The optimal speed is activated.

6.3 Adjusting the upper thread tension

The basic setting of the upper thread tension is set automatically as soon as the embroidery motif is selected.

The upper thread tension is set optimally at the BERNINA factory and the machine has been tested.

Metrosene-/Seralon thread size 100/2 (Company Mettler, Switzerland) is used for upper and bobbin thread.

When of using other types of sewing or embroidery threads, the optimal tension may vary. Therefore it may be necessary to adjust the upper thread tension according to the embroidering project as well as the desired the embroidery motif individually.

The higher the upper thread tension, the tighter the upper thread which means that the bobbin thread is pulled up to the top of the fabric. When the upper thread tension is low, the upper thread is less tightened which means that the bobbin thread is pulled up less.

Alteration of the upper thread tension affect all embroidery motifs. Permanent alterations of the upper thread tension can be made in the Setup Program (see page 53).



- > Touch the icon «Upper thread tension».
- > Move the slide using the touchscreen pen or the finger to increase or reduce the upper thread tension.

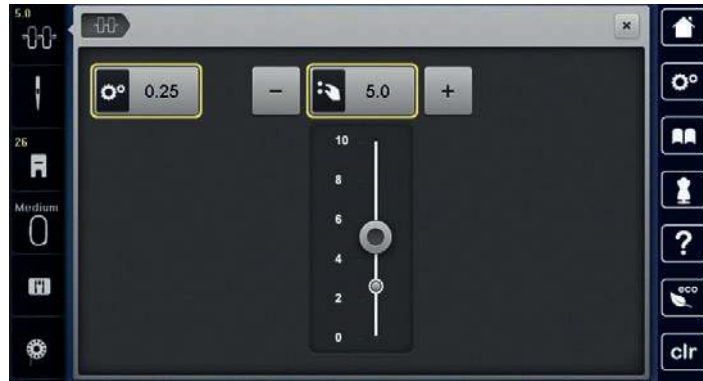

- > Touch the yellow-framed icon on the right to reset the alterations to basic setting.
- > When the upper thread tension has been altered in the Setup Program, touch the yellow-framed icon on the left to reset the alterations to basic setting in the **Setup Program**.

6.4 Embroidering via the foot control (Optional accessory)

Embroidering via the foot control is recommended when only a short sequence has to be embroidered. While embroidering, the foot control must be pressed down all the time.

- > Press the foot control to start embroidering.

7 Attachment

7.1 Maintenance and cleaning

Cleaning the display

- > Clean the display in the switched off status with a soft slightly damp microfiber cloth.

Removing thread remnants under the stitch plate



Electronically driven components

Risk of injury near the needle and the hook.

- > Switch the machine off and disconnect it from the power supply system.

Remove the thread remnants under the stitch plate regularly.

- > Remove the presser foot and the needle.
- > Remove the stitch plate.



- > Remove the thread remnants under the stitch plate.

Lubricating the machine



Electronically driven components

Risk of injury near the needle and the hook.

- > Switch the machine off and disconnect it from the power supply system.

Prerequisite:

- The stitch plate is removed.
- > Fill the oil depot with one drop of the supplied BERNINA oil.

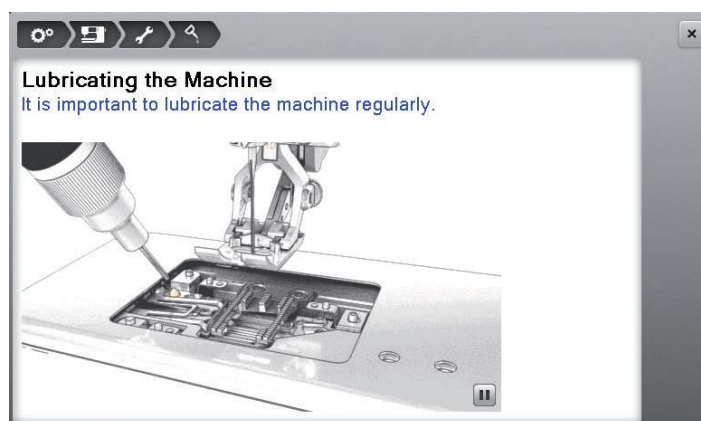

Cleaning the hook



Electronically driven components

Risk of injury near the needle and the hook.

- > Switch the machine off and disconnect it from the power supply system.

- > Open the bobbin cover.
- > Remove the bobbin case.
- > Press the release lever to the left.



- > Flap down the fastening bracket along with the black hook race cover.
- > Remove the hook.



- > Clean the hook race with a brush; do not use any pointed objects.
- > Hold the hook at the pin in the center with two fingers.
- > Lead the hook, lower edge ahead, angular top-down behind the hook race cover.
- > Position the hook with the two lugs meeting the openings in the hook, the colored mark on the hook driver should be visible through the hole in the hook.
- > Insert the hook.
 - The hook is magnetic and therefore fastened to the correct position.
- > Close the hook race cover and the fastening bracket until the release bracket engages.
- > As a check, turn the handwheel.
- > Insert the bobbin case.

Lubricating the hook

CAUTION

Electronically driven components

Risk of injury near the needle and the hook.

- > Switch the machine off and disconnect it from the power supply system.

NOTICE

Lubricating the hook

Too much oil can result in staining the fabric and the thread.

- > Give one drop of oil in each of the two oil depots. Embroider a test piece first.

- > Remove the bobbin case.
- > Press the release lever to the left.



- > Flap down the fastening bracket along with the black hook race cover.
- > Remove the hook.



- > Give one drop of oil in each of the two oil depots so that the felts are damp and make sure that the red-marked surface of the hook sleeve remains free of oil.



- > Hold the hook at the pin in the center with two fingers.
- > Lead the hook, lower edge ahead, angular top-down behind the hook race cover.



Attachment





- > Position the hook with the two lugs meeting the openings in the hook, the colored mark on the hook driver should be visible through the hole in the hook.
- > Insert the hook.
 - The hook is magnetic and therefore fastened to the correct position.
- > Close the hook race cover and the fastening bracket until the release bracket engages.
- > As a check, turn the handwheel.
- > Insert the bobbin case.



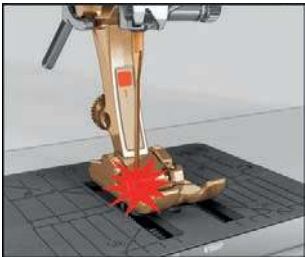

7.2 Troubleshooting

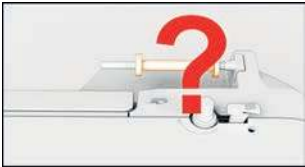

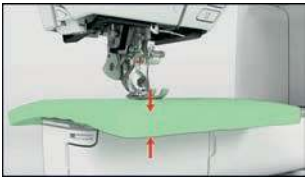
Fault	Cause	Repair
Uneven stitch formation	Upper thread too tight or too loose.	> Adjust upper thread tension.
	Needle blunt or bent.	> Replace the needle, make sure that a new BERNINA quality needle is used.
	Poor quality needle.	> Use a new BERNINA quality needle.
	Poor quality thread.	> Use quality thread.
	Incorrect needle/thread combination.	> Match the needle with the thread size.
	Incorrectly threaded.	> Rethread.
Uneven stitch formation	The incorrect bobbin case is used.	> Use the supplied bobbin case with triangles.
		
Skipped stitches	Incorrect needle.	> Use the needle system 130/705H.
	Needle blunt or bent.	> Replace the needle.
	Poor quality needle.	> Use a new BERNINA quality needle.
	The needle is incorrectly inserted.	> Insert the needle with the flat side to the back as far up as it will go into the needle holder and tighten the screw.
	Incorrect needle point.	> Match the needle point to the texture of the material.
Faulty stitching	Thread remnants between the thread tension discs.	> Fold a piece of thin material and slide the folded edge (not the raw edges) between the thread tension discs.
	Incorrectly threaded.	> Rethread.
	Thread remnants below the bobbin case spring.	> Remove the thread remnants under the spring.

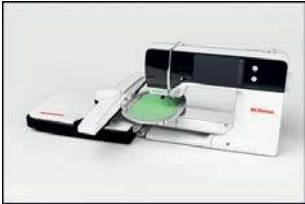
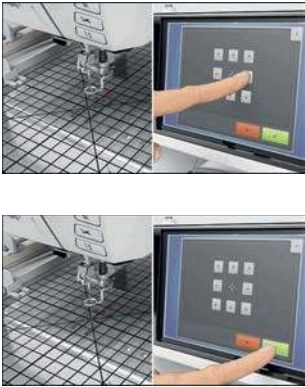

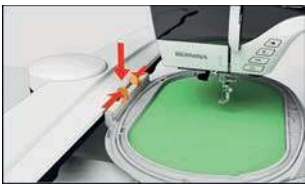
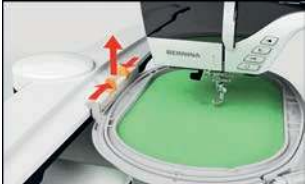
Fault	Cause	Repair
Upper thread breaks	Incorrect needle/thread combination.	> Match the needle with the thread size.
	Upper thread is too tight.	> Reduce the upper thread tension.
	Incorrectly threaded.	> Rethread.
	Poor quality thread.	> Use quality thread.
	The stitch plate or the hook tip is damaged.	> Contact the nearest specialized BERNINA dealer to have the damages repaired. > Replace the stitch plate.
	The thread is caught in the area of the thread take-up lever.	> Remove the screw (1) on the headframe with the angular Torx wrench. > Pull the headframe at the bottom slightly forward. > Flip the headframe upwards a bit and remove it. > Remove the thread remnants. > Attach the headframe and tighten the screw.
		
Lower thread breaks	The bobbin case is damaged.	> Replace the bobbin case.
	The stitch hole in the stitch plate is damaged.	> Contact the nearest specialized BERNINA dealer to have the damages repaired. > Replace the stitch plate.
	Needle blunt or bent.	> Replace the needle.
Needle breaks	The needle is incorrectly inserted.	> Insert the needle with the flat side to the back as far up as it will go into the needle holder and tighten the screw.
	Knotted thread.	> Use quality thread.
Display is inactive	Incorrect calibrating data.	> Switch the machine off. > Switch the machine on and simultaneously press the buttons «SET» and «Center of the embroidery motif» and keep pressed. > Re-calibrate the display.
	The eco-function is active.	> Touch the icon «eco-Mode».
The needle and the stitch plate do not match	The selected needle and stitch plate cannot be used in combination.	> Replace the needle. > Replace the stitch plate.
Speed too low	Unfavorable room temperature.	> Place the machine in a warm room one hour before use.
	Settings in the Setup Program.	> Adjust the sewing speed in the Setup Program. > Adjust the slide.

7.3 Error messages

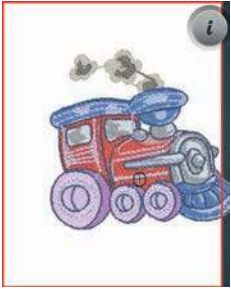
Message on the display	Cause	Repair
	The selected needle and stitch plate cannot be used in combination.	<ul style="list-style-type: none"> > Replace the needle. > Replace the stitch plate.
	The needle is not at its top end.	<ul style="list-style-type: none"> > Adjust the needle position via the handwheel.
	The upper thread is used up.	<ul style="list-style-type: none"> > Rethread.
	The upper thread has broken.	<ul style="list-style-type: none"> > Rethread.
	The bobbin thread is used up.	<ul style="list-style-type: none"> > Rethread.
	The bobbin thread has broken.	<ul style="list-style-type: none"> > Clean the hook. > Rethread.
	The main motor isn't running.	<ul style="list-style-type: none"> > Turn the handwheel clockwise until the needle is at its top position. > Remove the stitch plate. > Remove the thread remnants. > Clean the hook. > Remove the hook and make sure that there are no pieces of broken needle points on the magnetic back of the hook.
	The fabric under the presser foot is too thick.	<ul style="list-style-type: none"> > Reduce the fabric thickness.

Message on the display	Cause	Repair
	The contact between the machine and the embroidery module is interrupted due to vibrations.	<ul style="list-style-type: none"> > Make sure that the module and the machine are standing on a stable, even surface. > Connect the embroidery module to the machine.
	The needle position doesn't correspond with the center of the hoop.	<ul style="list-style-type: none"> > Calibrate the hoop.
	The embroidery module is not attached.	<ul style="list-style-type: none"> > Connect the embroidery module to the machine. > Contact the specialized BERNINA dealer to have the machine checked.
	The hoop is not attached.	<ul style="list-style-type: none"> > Attach the hoop.
	The hoop is attached.	<ul style="list-style-type: none"> > Remove the hoop.
	The movement of the hoop follows.	<ul style="list-style-type: none"> > Touch the icon «Confirm».

Message on the display	Cause	Repair
	The embroidery motif is partly outside the hoop.	> Reposition the embroidery motif and start embroidering it again.
	The embroidery motif is too large.	> Reduce the size of the embroidery motif. > Attach a bigger hoop.
Too less free capacity on the BERNINA USB stick (Optional accessory).	Not enough free capacity on the BERNINA USB stick (Optional accessory).	> Make sure that the BERNINA USB stick (Optional accessory) is used. > Delete data from the BERNINA USB stick (Optional accessory).
No personal data on the BERNINA USB stick (Optional accessory).	No personal data for recovery available on the BERNINA USB stick (Optional accessory).	> Make sure that the data and settings have been saved on the BERNINA USB stick (Optional accessory).
The recovery of personal data has failed.	The software update has been successful but the personal data couldn't be recovered.	> Make sure that the data and settings have been saved on the BERNINA USB stick (Optional accessory). > Transfer saved data to the machine.
No BERNINA USB stick is inserted. Make sure that during the complete automatic update always the same BERNINA USB stick remains inserted.	The BERNINA USB stick (Optional accessory) is not inserted.	> Use a BERNINA USB stick (Optional accessory) providing enough free capacity.

Message on the display	Cause	Repair
The update of the software has failed.	The latest software version cannot be found on the USB stick.	<ul style="list-style-type: none"> > Make sure that the data for the software update has been unzipped. > Check whether the data for the software update are saved directly on the data medium and not in a file on the USB stick. > Update the software.
 	The machine needs cleaning/lubricating.	<ul style="list-style-type: none"> > Clean the machine. > Lubricate the machine. <p>Important information on lubricating:</p> <ul style="list-style-type: none"> > Too much oil can result in staining the fabric or the thread. > After lubricating, always embroider on a test piece.
It is time for the regular maintenance. Please contact your specialized BERNINA dealer to make an appointment.	<p>The machine needs maintenance. The message appears after the programmed service interval has expired.</p> <p>Important information: Having your machine cleaned and serviced properly at the appropriate times ensures its proper functioning and a long service life. Failure to do so may adversely affect service life and limit the guarantee. The charge for servicing is nationally regulated – consult your dealer or servicing shop for more details.</p>	<ul style="list-style-type: none"> > Contact the specialized BERNINA dealer. > Delete the message temporarily by touching the icon «ESC». <p>Having cleared the message three times, the message will appear as recently as the next service interval has been completed.</p>

7.4 Storage and disposal

Storing the machine

It is recommended to store the machine in the original packaging. If the machine is stored in a cold room, place it in a warm room one hour before use.

- > Switch the machine off and disconnect it from the power supply system.
- > Don't store the machine outdoor.
- > Protect the machine against climatic influences.

Dispose of the machine

BERNINA International AG is committed to the protection of the environment. We strive to minimize the environmental impact of our products by continuously improving product design and our technology of manufacturing.

When the machine won't be used anymore, dispose this product in an environmentally responsible way according to the national directive. Do not throw away this product with your household waste. When in doubt, bring the machine to your local specialized BERNINA dealer.

- > Clean the machine.
- > Sort the components by their materials and dispose of them according to the local laws and regulations.

7.5 Technical data

Term	Value	Measurement unit
Maximum fabric thickness	12.5	mm
Sewing light	30	LED
Maximum speed	1000	spm/rpm
Measurements without the spool pin	522/214/358	mm
Weight	14	kg
Energy consumption	140	Watt
Input voltage	100-240	Volt
Protection class (Electrical engineering)	II	













8 Overview motifs

8.1 Overview Embroidery motifs

Editing embroidery motifs

Let your inspiration run free. A vast selection of embroidery motifs is at your disposal.

If you see one of the following pictograms below a number of the embroidery motif, you can find additional information at www.bernina.com/7series.









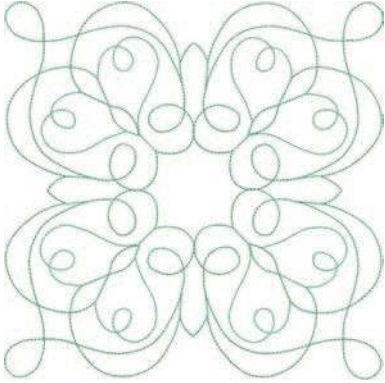

	Detached point		Punchwork Design (sample)
	Hole embroidery		Cord embroidery
	Fringe embroidery		Projects in the hoop
	Appliqué		Puffy fonts
	CutWork Design (motif)		Quilting
	PaintWork Design (motif)		Trapunto
	CrystalWork Design (motif)		

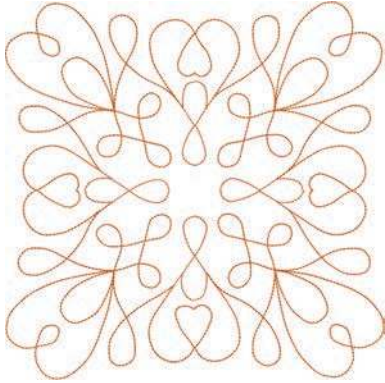

Projects

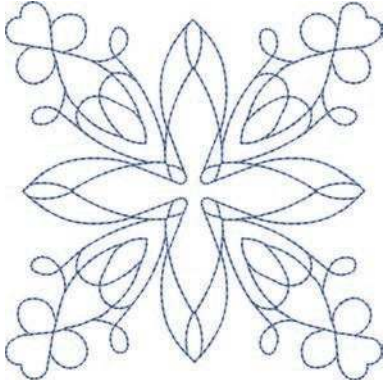



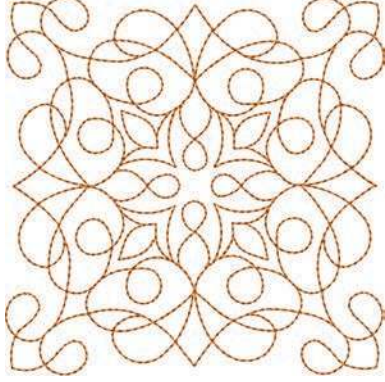





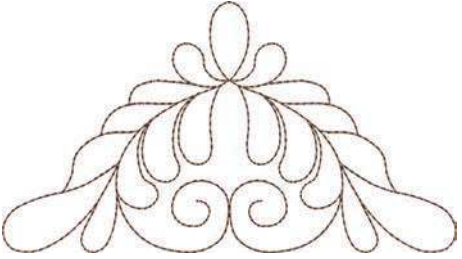

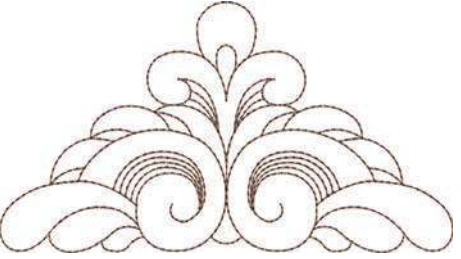

Please find the detailed embroidery instructions at www.bernina.com/700designs





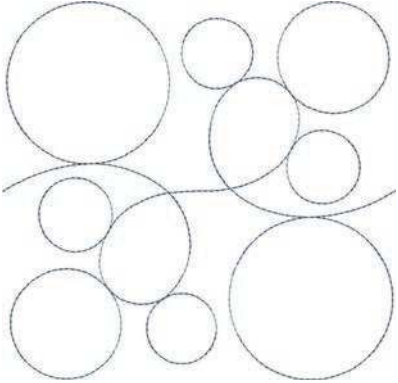

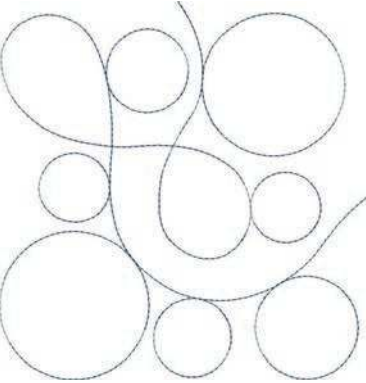



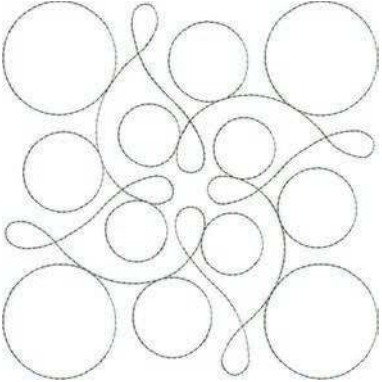

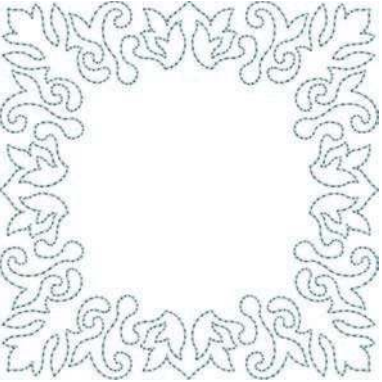



No. Width x Height in mm	Embroidery motif Colors	No. Width x Height in mm	Embroidery motif Colors
BE700701  208.7 X 201.6	 	12604-02  45.0 x 152.8	 
21519-03  108.4 x 161.2	 	19999-032  90.4 x 143.0	 







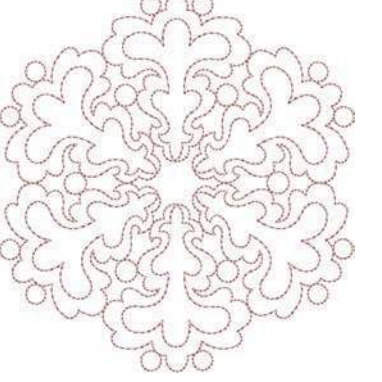





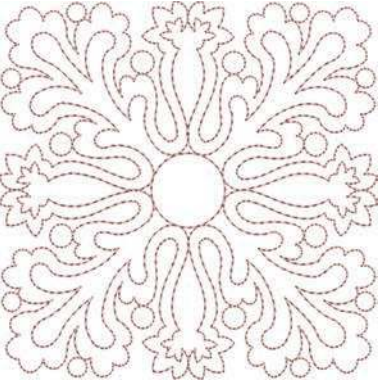

Quilt motifs

No.	Embroidery motif	No.	Embroidery motif
Width x Height in mm	Colors	Width x Height in mm	Colors
BD289  95.0 x 94.7		BD285  202.0 x 201.0	
BD288  202.0 x 201.0		BD292  94.8 x 95.1	
BD299  94.5 x 95.0		BD308  95.0 x 94.4	



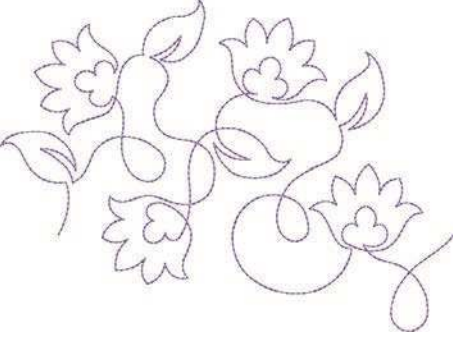

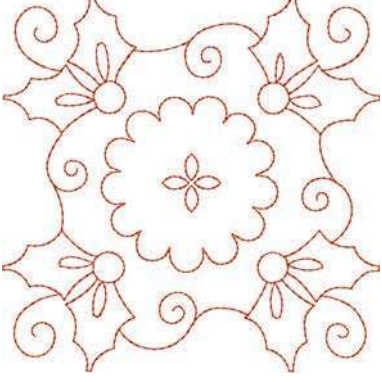











No.	Embroidery motif	No.	Embroidery motif
Width x Height in mm	Colors	Width x Height in mm	Colors
BD413  97.1 x 97.2	 	BD837  123.6 x 123.6	 
12380-43  123.5 x 123.5	 	12380-30  89.2 x 96.3	 
12380-04  83.1 x 89.9	 	12380-08  89.2 x 89.1	 

No.	Embroidery motif	No.	Embroidery motif
Width x Height in mm	Colors	Width x Height in mm	Colors
12380-09  111.6 x 61.6	 	12380-22  110.6 x 60.9	 
12380-10  152.0 x 356.7	 	BD796  47.2 x 174.5	 
BD800  127.3 x 122.4	 	BD801  122.2 x 124.2	 



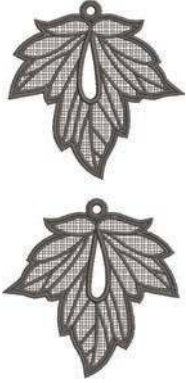













No.	Embroidery motif	No.	Embroidery motif
Width x Height in mm	Colors	Width x Height in mm	Colors
BD804  122.9 x 123.6	 	BD394  97.0 x 96.8	 
BD412  89.4 x 53.2	 	BD513  63.5 x 63.4	 
BD514  63.5 x 62.9	 	BD553  113.8 x 121.1	 



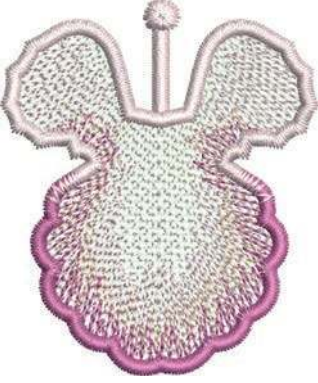



No.	Embroidery motif	No.	Embroidery motif
Width x Height in mm	Colors	Width x Height in mm	Colors
BD567  107.9 x 108.2	 	BD554  109.9 x 109.9	 
BD659  66.6 x 219.1	 	BD665  160.3 x 117.8	 
HE959  120.6 x 120.6	 		

Borders and Lace

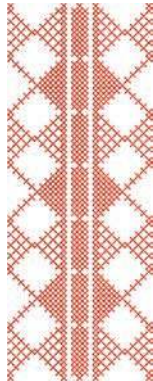













No.	Embroidery motif	No.	Embroidery motif
Width x Height in mm	Colors	Width x Height in mm	Colors
82011-30  107.2 x 130.3	 	82011-28  133.6 x 99.4	 
NB952  108.2 x 119.4	 	OC00303  100.6 x 110.6	 
12410-08  80.5 x 168.3	 	12410-07  115.5 x 158.8	 







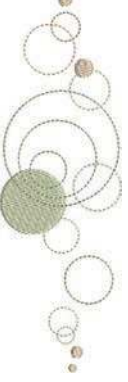







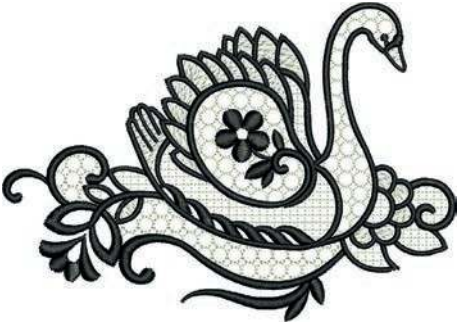

Overview motifs

No.	Embroidery motif	No.	Embroidery motif
Width x Height in mm	Colors	Width x Height in mm	Colors
12410-15  29.1 x 133.5	 	12454-05  117.0 x 108.3	 
12454--06  116.6 x 47.6	 	12454-07  48.5 x 57.4	 
FA981 35.1 x 142.3	 	BE790701 113.6 x 230.1	 



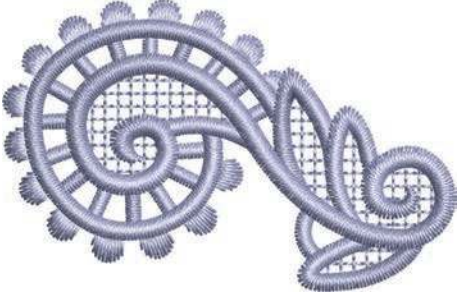







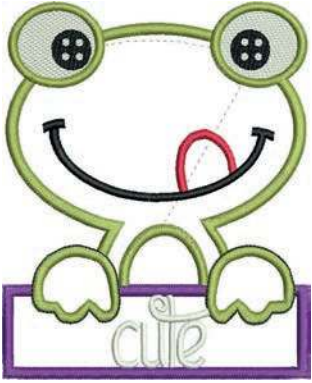

No. Width x Height in mm	Embroidery motif Colors	No. Width x Height in mm	Embroidery motif Colors
BE790704 72.5 x 217.2	 	BE790703 70.7 x 185.0	 
BE790702 73.0 x 190.5	 	21013-29 40.2 x 152.0	 
21013-30 75.8 x 75.9	 	12398-29  26.4 x 152.9	 









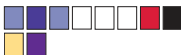





Overview motifs













No.	Embroidery motif	No.	Embroidery motif
Width x Height in mm	Colors	Width x Height in mm	Colors
12398-30  76.8 x 76.9	 	OC33411  24.2 x 177.1	 
CM471 59.1 x 190.8	 	FB403 52.2 x 208.5	 
FQ785 92.6 x 342.0	 	FQ969 51.6 x 161.9	 





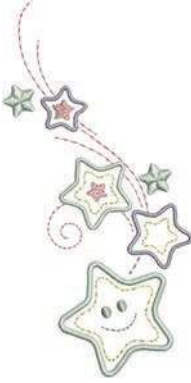





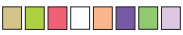

No.	Embroidery motif	No.	Embroidery motif
Width x Height in mm	Colors	Width x Height in mm	Colors
FQ736 7.9 x 253.1	 	BD582 48.6 x 171.1	 
NA912 115.1 x 15.8	 	NA914 120.3 x 18.8	 
NB478 121.7 x 85.5	 	FQ945 93.8 x 95.1	 
FB422  52.3 x 33.8	 	FB423  132.9 x 53.6	 

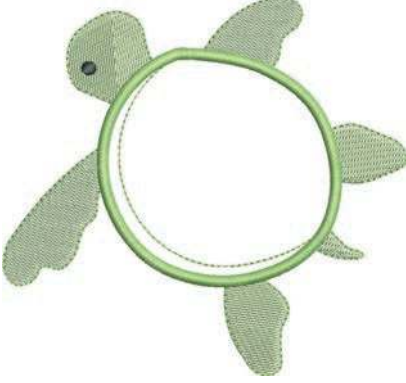
Children

No. Width x Height in mm	Embroidery motif Colors	No. Width x Height in mm	Embroidery motif Colors
BE790305  118.3 x 145.5	 	12535-03 160.6 x 120.3	 
BE790302 68.3 x 66.3	 	BE790303 69.5 x 70.1	 
BE790304 127.2 x 65.8	 	BE790307  141.5 x 126.9	 







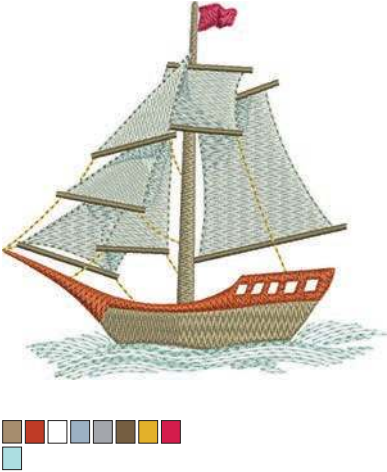





No. Width x Height in mm	Embroidery motif Colors	No. Width x Height in mm	Embroidery motif Colors
BE790308  191.3 x 219.6	 	12421-03 45.8 x 48.3	 
NB193 113.3 x 96.2	 	CM384 77.4 x 80.7	 
CM226  63.3 x 63.1	 	CM193  106.7 x 127.4	 

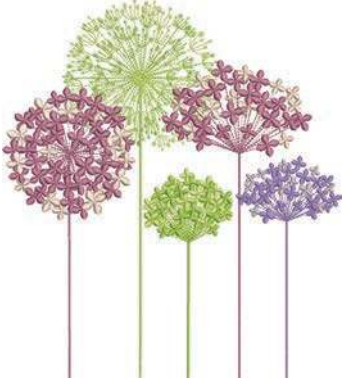









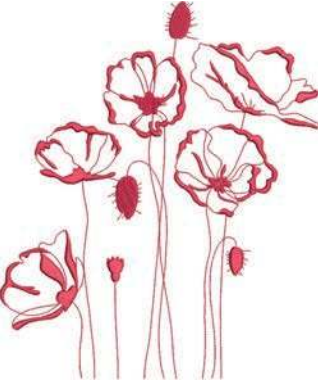

No. Width x Height in mm	Embroidery motif Colors	No. Width x Height in mm	Embroidery motif Colors
CM220  71.5 x 71.8	 	WP325 77.9 x 94.0	 
CM428 78.2 x 106.4	 	CM404 47.2 x 165.4	 
CM368 70.2 x 140.1	 	CM147 55.0 x 99.6	 













No. Width x Height in mm	Embroidery motif Colors	No. Width x Height in mm	Embroidery motif Colors
CM022 89.1 x 97.1	 	CM442 46.5 x 47.0	 
CM362  120.6 x 113.0	 	WP201 76.2 x 92.0	 
CM286 97.9 x 82.4	 	CK970 84.8 x 81.6	 





No. Width x Height in mm	Embroidery motif Colors	No. Width x Height in mm	Embroidery motif Colors
RC765 100.5 x 99.0			

Flowers

No.	Embroidery motif	No.	Embroidery motif
Width x Height in mm	Colors	Width x Height in mm	Colors
80001-23 85.0 x 101.6	 	82006-02 128.6 x 205.1	 
BE790404 202.0 x 225.8	 	12392-1  112.6 x 157.4	 
12392-13 112.6 x 203.4	 	12457-13 113.1 x 130.3	 



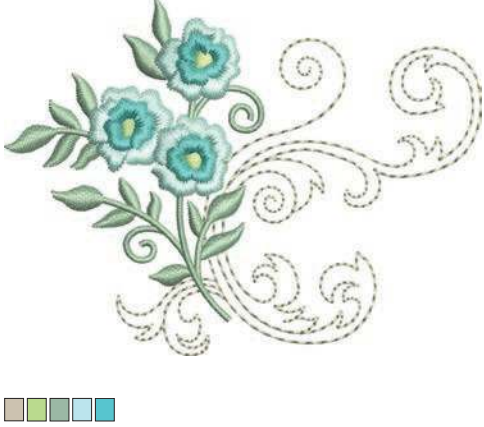

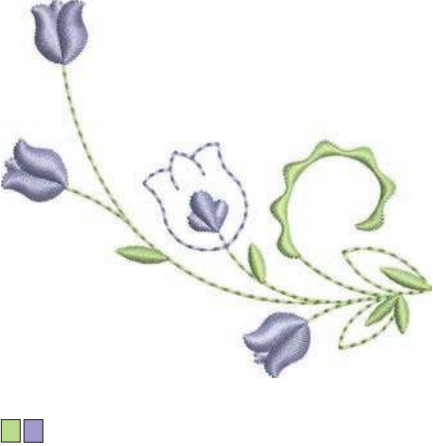







No.	Embroidery motif	No.	Embroidery motif
Width x Height in mm	Colors	Width x Height in mm	Colors
12457-06 106.3 x 172.3	 	BE790401 205.7 x 242.0	 
BE790405 125.9 x 185.4	 	FS142 69.3 x 143.8	 
82004-34  198.8 x 281.3	 	BE790409 188.4 x 215.3	 







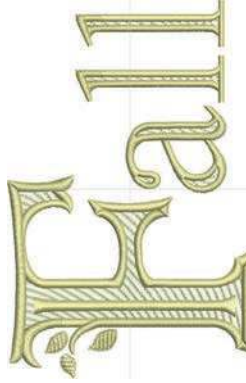





No.	Embroidery motif	No.	Embroidery motif
Width x Height in mm	Colors	Width x Height in mm	Colors
FB268 123.7 x 87.3	 	FQ934 119.1 x 192.4	 
CM418 45.7 x 87.4	 	FQ972 111.6 x 73.2	 
FQ548 93.8 x 159.3	 	NB513 103.7 x 111.7	 



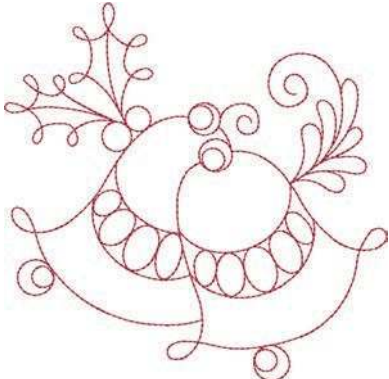

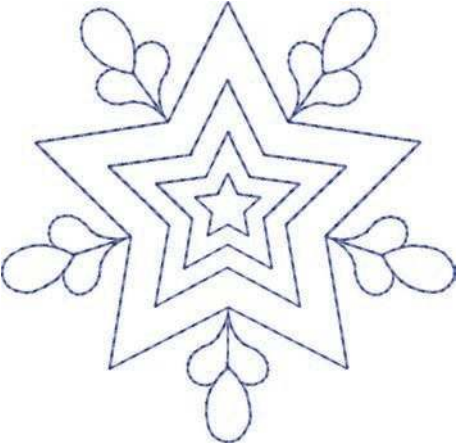







No. Width x Height in mm	Embroidery motif Colors	No. Width x Height in mm	Embroidery motif Colors
FQ274 63.0 x 77.7		NB668 114.3 x 165.1	
FQ331 84.6 x 63.5		FQ738 51.6 x 101.4	
FQ434 100.0 x 162.2		FB419 64.3 x 56.5	

No. Width x Height in mm	Embroidery motif Colors	No. Width x Height in mm	Embroidery motif Colors
WS673 67.7 x 170.1			

Seasons







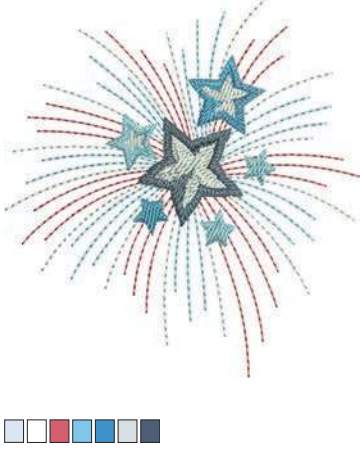





No.	Embroidery motif	No.	Embroidery motif
Width x Height in mm	Colors	Width x Height in mm	Colors
12384-02 132.9 x 203.4	 	12384-11 84.3 x 189.8	 
12443-03 120.5 x 161.4	 	12443-11 73.4 x 193.1	 
12427-01 133.8 x 167.6	 	12427-11 81.6 x 126.2	 







No. Width x Height in mm	Embroidery motif Colors	No. Width x Height in mm	Embroidery motif Colors
12400-03 123.4 x 161.3	 	12400-11 74.1 x 211.9	 
HG319 88.6 x 151.5	 	HG301 123.9 x 122.4	 
BD603 80.7 x 78.3	 	HE919 89.1 x 69.2	 





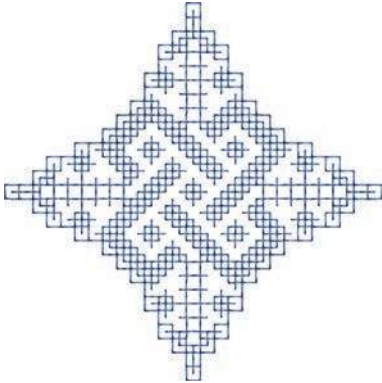





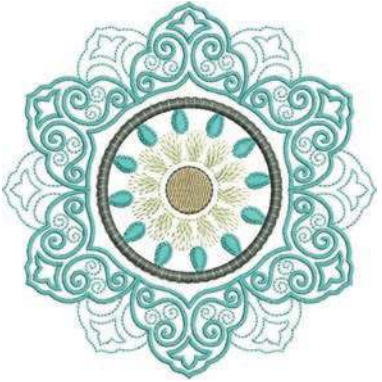

No.	Embroidery motif	No.	Embroidery motif
Width x Height in mm	Colors	Width x Height in mm	Colors
HG053 122.1 x 121.8	 	NB317 87.4 x 86.9	 
NB769 128.5 x 124.7	 	NA146 63.3 x 69.6	 
NB039 97.0 x 127.0	 	FQ749 77.6 x 94.8	 





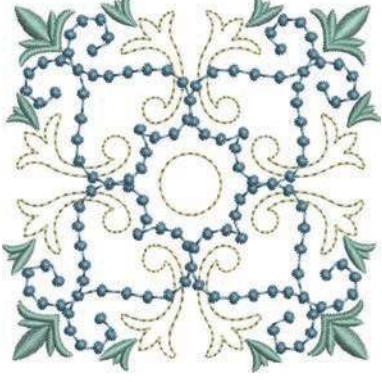





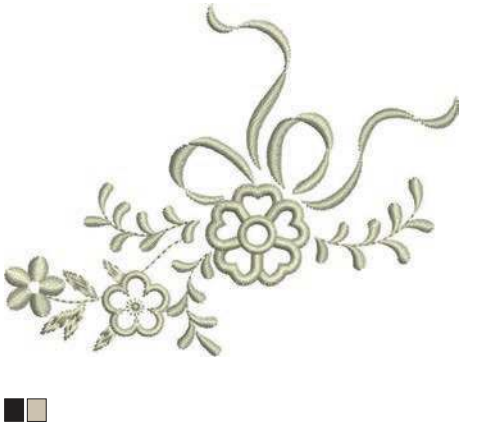

No. Width x Height in mm	Embroidery motif Colors	No. Width x Height in mm	Embroidery motif Colors
HG460 91.8 x 98.1			





Embellishment







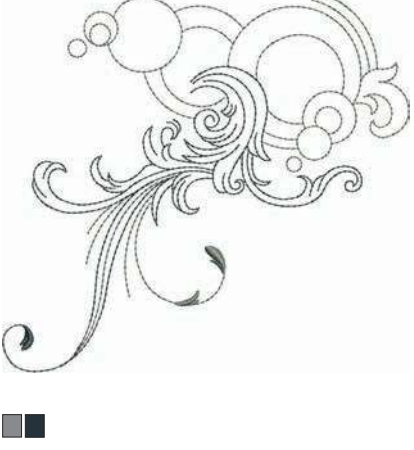





No.	Embroidery motif	No.	Embroidery motif
Width x Height in mm	Colors	Width x Height in mm	Colors
BE790501 199.5 x 276.4	 	WP428 132.4 x 119.0	 
12576-05 189.5 x 229.4	 	12473-04 93.6 x 184.2	 
12620-12 94.6 x 109.4	 	21008-15 119.5 x 119.9	 













No. Width x Height in mm	Embroidery motif Colors	No. Width x Height in mm	Embroidery motif Colors
82006-30  99.9 x 174.6	 	BE790503 130.0 x 130.9	 
BE790504 121.3 x 121.3	 	FB126 86.9 x 102.2	 
82005-01  175.6 x 109.1	 	21003-26  123.0 x 124.1	 



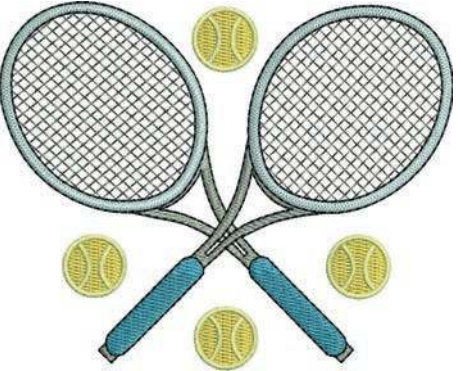

No.	Embroidery motif	No.	Embroidery motif
Width x Height in mm	Colors	Width x Height in mm	Colors
82006-36  121.8 x 123.0	 	BE790403 140.0 x 130.4	 
NB018 90.3 x 97.1	 	NB728 97.5 x 112.6	 
NB403 78.1 x 78.3	 	HG079 116.0 x 116.1	 

No. Width x Height in mm	Embroidery motif Colors	No. Width x Height in mm	Embroidery motif Colors
FB457 107.7 x 83.6	 	FQ881 129.2 x 129.3	 
FB336 122.0 x 122.0	 	FB377 121.0 x 92.5	 
FQ870 122.1 x 105.1	 	FB385 131.1 x 127.8	 









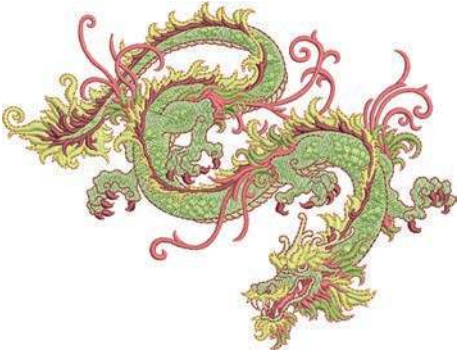

No.	Embroidery motif	No.	Embroidery motif
Width x Height in mm	Colors	Width x Height in mm	Colors
FQ072 79.7 x 101.6		NB101 99.2 x 99.3	
NB373 121.4 x 176.8		WS649 125.4 x 248.3	
NB708 137.8 x 127.7		FB433 120.9 x 120.9	







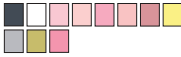

No.	Embroidery motif	No.	Embroidery motif
Width x Height in mm	Colors	Width x Height in mm	Colors
BE790605 79.5 x 79.5	 	BE790606 100.2 x 86.0	 
BE790607 79.8 x 74.4	 	BE790608 80.3 x 80.1	 
SP980 63.2 x 63.5	 	NB036 35.7 x 69.9	 





No.	Embroidery motif	No.	Embroidery motif
Width x Height in mm	Colors	Width x Height in mm	Colors
RC244 88.4 x 53.4	 	RC675 101.6 x 79.9	 
SP266 75.8 x 54.2	 	SP989 101.6 x 82.5	 
SR067 87.5 x 96.9	  	LT870 97.5 x 57.0	 

No. Width x Height in mm	Embroidery motif Colors	No. Width x Height in mm	Embroidery motif Colors
SR589 66.5 x 95.2	 	FB158 39.5 x 53.3	 

Asia

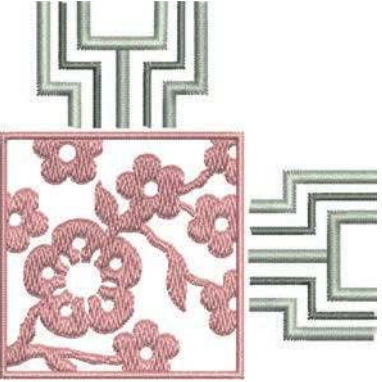
No. Width x Height in mm	Embroidery motif Colors	No. Width x Height in mm	Embroidery motif Colors
NB124 172.4 x 132.0	 	BE790801 137.8 x 137.7	 
BE790802 36.2 x 116.9	 	BE790803 22.4 x 215.9	 
FQ212 61.6 x 61.9	 	FB492 86.8 x 293.2	 



No. Width x Height in mm	Embroidery motif Colors	No. Width x Height in mm	Embroidery motif Colors
FQ194 120.2 x 118.5	 	FQ217 84.8 x 59.2	 
FA427 111.8 x 66.1	 	FB276 124.8 x 112.1	 



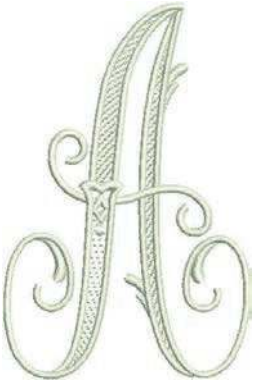
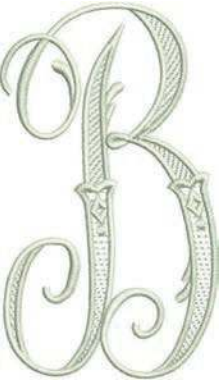
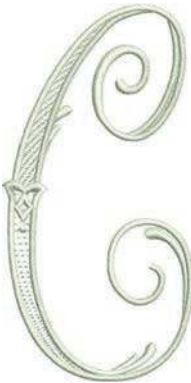
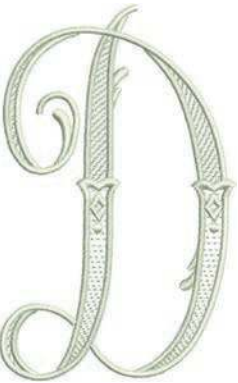
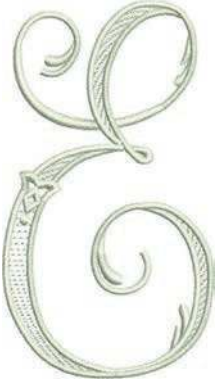
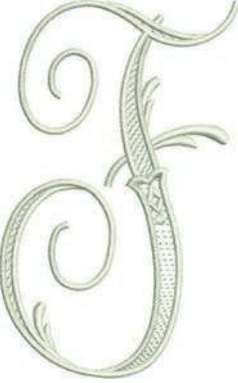

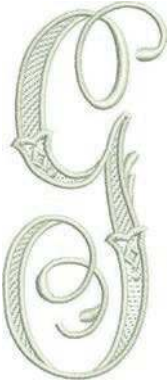
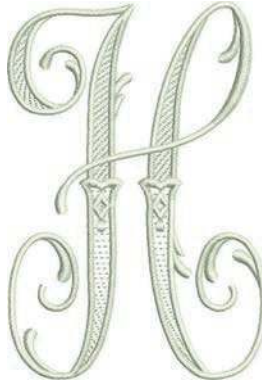
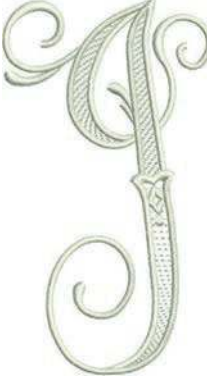
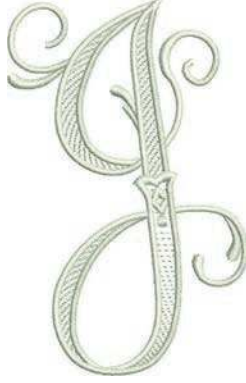
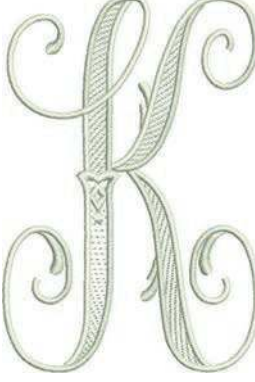
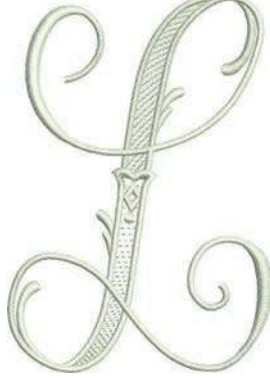
No.	Embroidery motif	No.	Embroidery motif
Width x Height in mm	Colors	Width x Height in mm	Colors
FB283 102.4 x 109.4	 ■ ■	FB490 67.7 x 67.7	 ■ ■ ■
FB491 31.7 x 165.6	 ■ ■ ■	NB491 79.2 x 168.4	 ■
FB484 66.8 x 59.2	 ■	WP423 90.4 x 157.9	 ■ ■ ■ ■

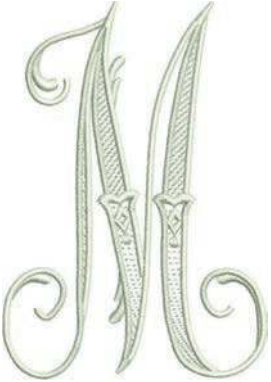
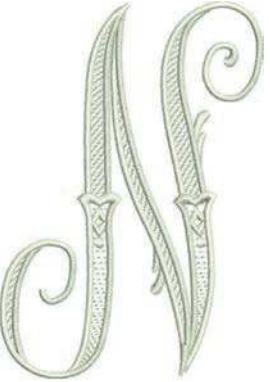
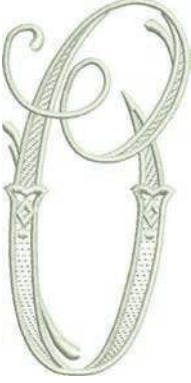
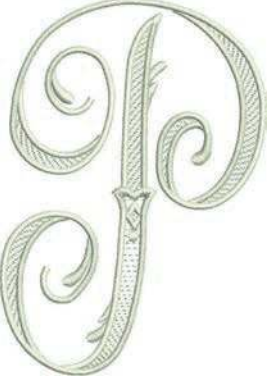

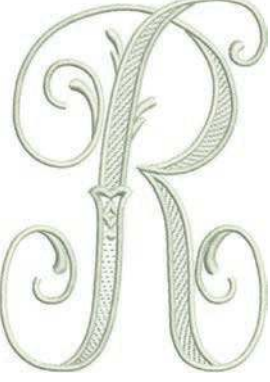



Charming Monograms

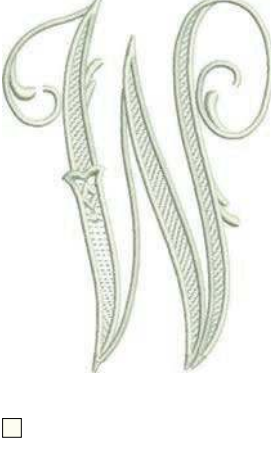
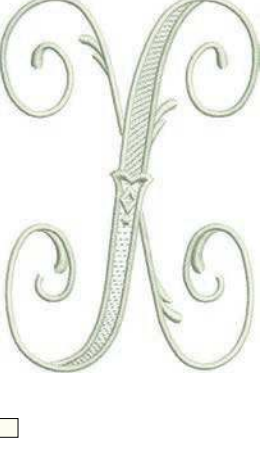

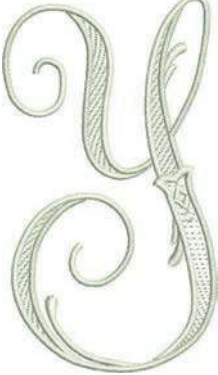



No.	Embroidery motif	No.	Embroidery motif
Width x Height in mm	Colors	Width x Height in mm	Colors
12587-01 58.7 x 89.7	 <input type="checkbox"/>	12587-02 52.0 x 89.9	 <input type="checkbox"/>
12587-03 45.4 x 89.9	 <input type="checkbox"/>	12587-04 56.8 x 90.6	 <input type="checkbox"/>
12587-05 50.4 x 90.2	 <input type="checkbox"/>	12587-06 57.0 x 89.7	 <input type="checkbox"/>

No.	Embroidery motif	No.	Embroidery motif
Width x Height in mm	Colors	Width x Height in mm	Colors
12587-07 39.1 x 90.4	 <input type="checkbox"/>	12587-08 61.9 x 90.3	 <input type="checkbox"/>
12587-09 49.4 x 89.2	 <input type="checkbox"/>	12587-10 56.9 x 89.5	 <input type="checkbox"/>
12587-11 61.7 x 90.7	 <input type="checkbox"/>	12587-12 63.2 x 90.1	 <input type="checkbox"/>

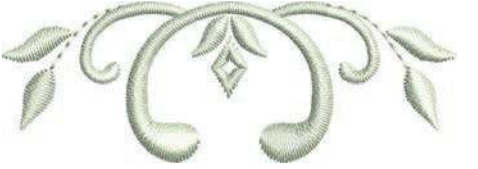









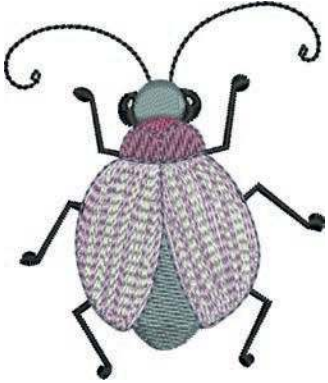

No.	Embroidery motif	No.	Embroidery motif
Width x Height in mm	Colors	Width x Height in mm	Colors
12587-13 64.4 x 92.1	 <input type="checkbox"/>	12587-14 63.1 x 90.4	 <input type="checkbox"/>
12587-15 44.5 x 90.1	 <input type="checkbox"/>	12587-16 63.2 x 89.6	 <input type="checkbox"/>
12587-17 54.2 x 89.2	 <input type="checkbox"/>	12587-18 64.1 x 90.3	 <input type="checkbox"/>









No.	Embroidery motif	No.	Embroidery motif
Width x Height in mm	Colors	Width x Height in mm	Colors
12587-19 56.1 x 90.4		12587-20 56.9 x 89.9	
12587-21 62.0 x 91.1		12587-22 64.4 x 91.3	
12587-23 64.6 x 90.2		12587-24 62.4 x 90.7	

No.	Embroidery motif	No.	Embroidery motif
Width x Height in mm	Colors	Width x Height in mm	Colors
12587-25 51.7 x 91.5	 <input type="checkbox"/>	12587-26 67.8 x 89.6	 <input type="checkbox"/>
12587-53 67.4 x 22.9	 <input type="checkbox"/>	12587-54 50.1 x 106.8	 <input type="checkbox"/>
12587-55 70.5 x 144.7	 <input type="checkbox"/>	12587-56 49.0 x 100	 <input type="checkbox"/>









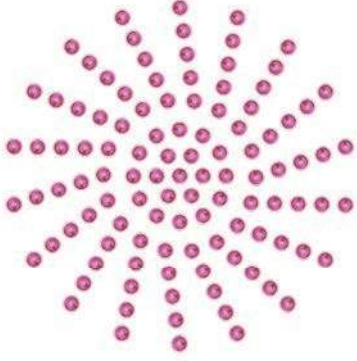

No. Width x Height in mm	Embroidery motif Colors	No. Width x Height in mm	Embroidery motif Colors
12587-57 57.5 x 20.3	 <input type="checkbox"/>	12587-58 52.9 x 116.3	 <input type="checkbox"/>
12587-59 33.0 x 94.7	 <input type="checkbox"/>	12587-60 126.1 x 126.0	 <input type="checkbox"/>
12587-61 35.7 x 28.8	 <input type="checkbox"/>	12587-62 35.6 x 33.8	 <input type="checkbox"/>

Animals

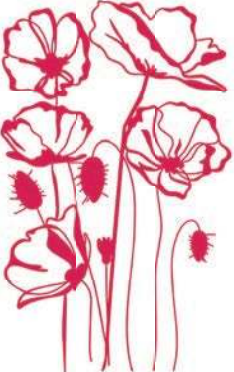

No.	Embroidery motif	No.	Embroidery motif
Width x Height in mm	Colors	Width x Height in mm	Colors
CM140 88.1 x 97.7	 	CM142 56.5 x 66.7	 
FB258 83.2 x 184.0	 	FQ106 109.3 x 108.9	 
FQ617 118.0 x 198.3	 	FQ624 64.5 x 144.2	 

No.	Embroidery motif	No.	Embroidery motif
Width x Height in mm	Colors	Width x Height in mm	Colors
MT022 123.2 x 125.4	 	MT028 103.3 x 93.4	 
WM785 84.6 x 103.4	 	WP217 93.3 x 78.1	 
WP244 136.8 x 172.4	 	WS610 127.3 x 111.1	 

DesignWorks design

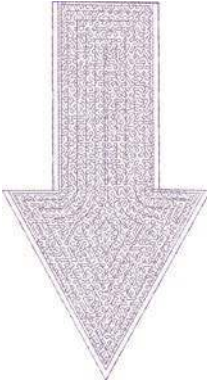

No. Width x Height in mm	Embroidery motif Colors	No. Width x Height in mm	Embroidery motif Colors
DW11 		BE790901 	
BE790903 		BE790905 	
BE790906 		BE790909 	







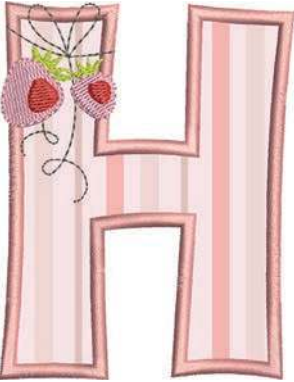

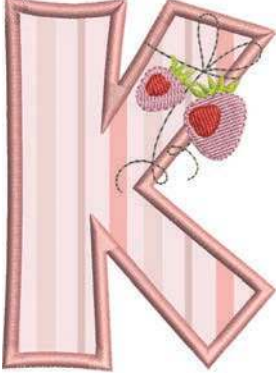





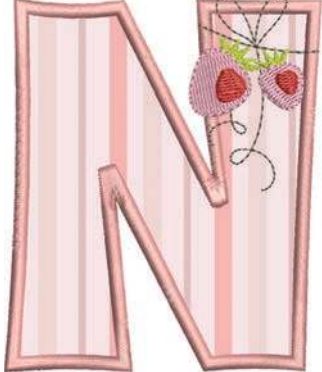

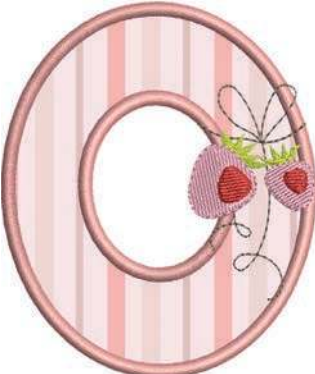
No.	Embroidery motif	No.	Embroidery motif
Width x Height in mm	Colors	Width x Height in mm	Colors
DW07 		DW05 	
DW10 		DW08 	
BE700121  206.5 x 207.5		BE700122  119.4 x 37.0	

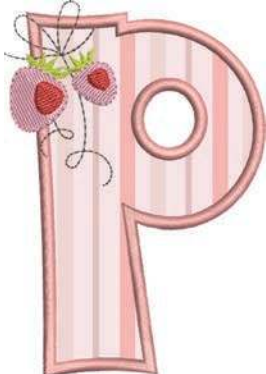

No.	Embroidery motif	No.	Embroidery motif
Width x Height in mm	Colors	Width x Height in mm	Colors
BE700123  112.7 x 205.8		BE700124  141.0 x 134.4	



Monograms in pink

No.	Embroidery motif	No.	Embroidery motif
Width x Height in mm	Colors	Width x Height in mm	Colors
BE790101 75.0 x 89.4	 	BE790102 73.0 x 89.4	 
BE790103 64.7 x 92.8	 	BE790104 90.4 x 97.5	 
BE790105 60.9 x 89.6	 	BE790106 63.5 x 89.9	 

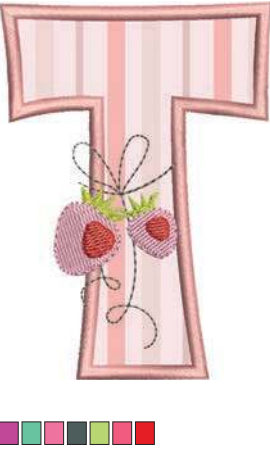
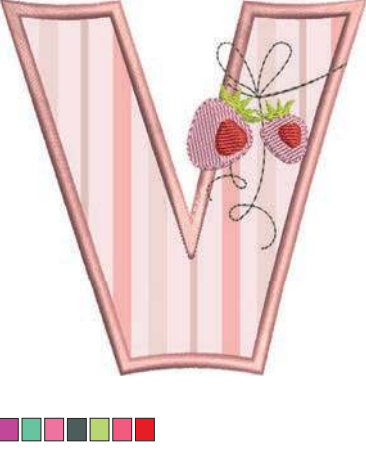



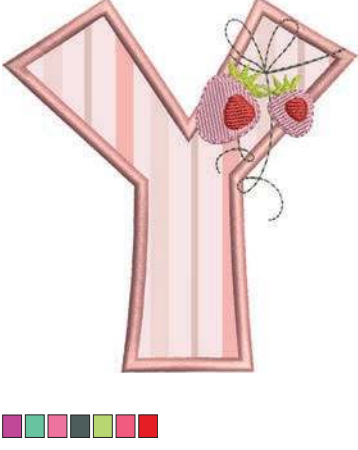

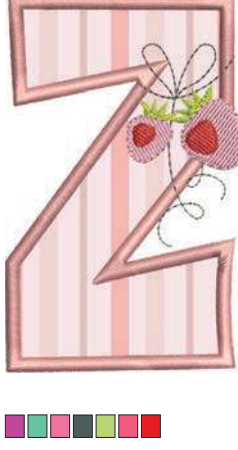





No.	Embroidery motif	No.	Embroidery motif
Width x Height in mm	Colors	Width x Height in mm	Colors
BE790107 79.6 x 89.9	 	BE790108 70.5 x 90.0	 
BE790109 32.2 x 100.6	 	BE790110 73.5 x 89.4	 
BE790111 65.0 x 89.4	 	BE790112 70.1 x 89.7	 











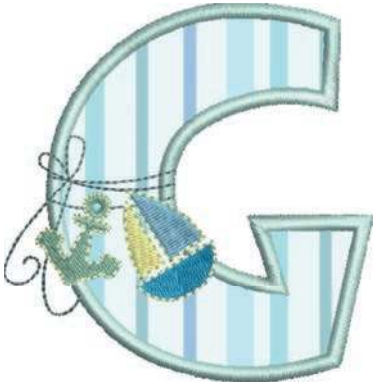

No. Width x Height in mm	Embroidery motif Colors	No. Width x Height in mm	Embroidery motif Colors
BE790113  88.8 x 90.1	 	BE790114  76.4 x 90.6	 
BE790115  74.4 x 89.3	 	BE790116  71.1 x 102.9	 
BE790117  82.1 x 100.8	 	BE790118  73.6 x 103.8	 





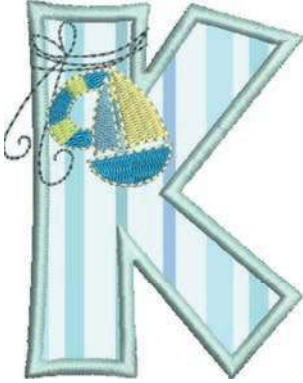

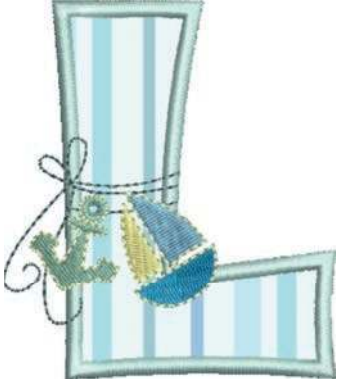











No.	Embroidery motif	No.	Embroidery motif
Width x Height in mm	Colors	Width x Height in mm	Colors
BE790119 60.6 x 89.5		BE790120 71.8 x 99.6	
BE790121 77.4 x 89.7		BE790122 86.9 x 89.3	
BE790123 104.6 x 89.4		BE790124 90.6 x 92.2	

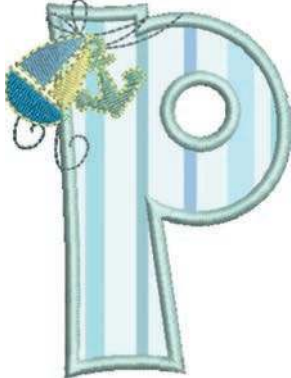











No. Width x Height in mm	Embroidery motif Colors	No. Width x Height in mm	Embroidery motif Colors
BE790125  84.1 x 89.4		BE790126  56.5 x 88.9	

Monograms in blue

No.	Embroidery motif	No.	Embroidery motif
Width x Height in mm	Colors	Width x Height in mm	Colors
BE790201 84.9 x 95.3	 	BE790202 79.7 x 95.1	 
BE790203 78.7 x 95.3	 	BE790204 104.4 x 96.5	 
BE790205 83.7 x 95.2	 	BE790206 77.7 x 96.0	 

No.	Embroidery motif	No.	Embroidery motif
Width x Height in mm	Colors	Width x Height in mm	Colors
BE790207 92.8 x 95.3	 	BE790208 87.7 x 95.3	 
BE790209 51.3 x 111.0	 	BE790210 88.7 x 95.6	 
BE790211 75.5 x 95.3	 	BE790212 83.3 x 95.3	 

No. Width x Height in mm	Embroidery motif Colors	No. Width x Height in mm	Embroidery motif Colors
BE790213  99.7 x 101.3	 	BE790214  89.9 x 94.8	 
BE790215  87.9 x 95.3	 	BE790216  71.6 x 94.9	 
BE790217  86.3 x 102.2	 	BE790218  82.6 x 95.1	 

No.	Embroidery motif	No.	Embroidery motif
Width x Height in mm	Colors	Width x Height in mm	Colors
BE790219 79.2 x 95.3	 	BE790220 69.1 x 95.3	 
BE790221 89.9 x 95.6	 	BE790222 92.9 x 95.7	 
BE790223 114.7 x 95.2	 	BE790224 93.1 x 95.2	 

No. Width x Height in mm	Embroidery motif Colors	No. Width x Height in mm	Embroidery motif Colors
BE790225  89.1 x 95.3	 	BE790226  59.3 x 95.9	 

A

Activating the audio signals	57
Activating the bobbin thread indicator	57
Activating the upper thread indicator	56
Adjusting the brightness of the display	58
Adjusting the sewing light	58
Altering the stitch density	71
Attaching the hoop	50
Attaching the Module	46
Attaching the stitch plate	38

B

Back to basic setting	59
-----------------------	----

C

Calibrating the display	59
Calibrating the hoop	54
Calling up the embroidery consultant	65
Calling up the help	65
Calling up the tutorial	65
Checking the firmware version	63
Child safety feature	65
Cleaning the hook	92
Cleaning the thread catcher	61
Combining embroidery motifs	76
Connecting the foot control	32

D

Dispose of the machine	102
------------------------	-----

E

Embroidery test	28
Error messages	98

F

Free point positioning	75
------------------------	----

G

Grid point positioning	75
------------------------	----

I

Inserting the embroidery needle	37
Introduction	13

K

Key to signs	14
--------------	----

L

Lubricating the hook	93
Lubricating the machine	62, 91

M

Maintenance and cleaning	91
--------------------------	----

N

Needle, Thread, Fabric	26
Needle/thread combination	27

O

Overview accessories	20
Overview Accessory Embroidery module	23
Overview Embroidery motifs	104

P

Placing the thread disc	35
Positioning the embroidery hoop virtually	52
Power save mode	65

R

Raising/Lowering the needle	34
Registering details of the dealer	63
Regulating the speed	66
Removing thread remnants under the stitch plate	91

S

Safety instructions	10
Saving Service data	64
Selecting a language	58
Selecting personal settings	56
Selecting the embroidery motif	47
Storing the machine	101

T

Technical data	103
Threading the bobbin thread	43
Threading the upper thread	39
Troubleshooting	95

U

Updating machine firmware	60
Using a spool net	35
Using eco mode	65

W

Welcome to the world of BERNINA	13
---------------------------------	----

