

User's Guide

Brilliance™ | 75Q

This household sewing machine is designed to comply with IEC/EN 60335-2-28 and UL1594.

IMPORTANT SAFETY INSTRUCTIONS

When using an electrical appliance, basic safety precautions should always be followed, including the following:

Read all instructions before using this household sewing machine. Keep the instructions at a suitable place close to the machine. Make sure to hand them over if the machine is given to a third party.

DANGER – To reduce the risk of electric shock:

- A sewing machine should never be left unattended when plugged in. The electrical socket, to which the machine is plugged in should be easily accessible. Always unplug this sewing machine from the electric outlet immediately after using and before cleaning, removing covers, lubricating or when making any other user servicing adjustments mentioned in the instruction manual.

WARNING – To reduce the risk of burns, fire, electric shock, or injury to person:

- Do not allow to be used as a toy. Close attention is necessary when this sewing machine is used by or near children.
- Use this sewing machine only for its intended use as described in this manual. Use only attachments recommended by the manufacturer as contained in this manual.
- Never operate this sewing machine if it has a damaged cord or plug, if it is not working properly, if it has been dropped or damaged, or dropped into water. Return the sewing machine to the nearest authorized dealer or service center for examination, repair, electrical or mechanical adjustment.
- Never operate the sewing machine with any air openings blocked. Keep ventilation openings of the sewing machine and foot control free from the accumulation of lint, dust, and loose cloth.
- Keep fingers away from all moving parts. Special care is required around the sewing machine needle.
- Always use the proper needle plate. The wrong plate can cause the needle to break.
- Do not use bent needles.
- Do not pull or push fabric while stitching. It may deflect the needle causing it to break.
- Wear safety glasses.
- Switch the sewing machine off (“0”) when making any adjustment in the needle area, such as threading needle, changing needle, threading bobbin, or changing presser foot, etc.
- Never drop or insert any object into any opening.
- Do not use outdoors.
- Do not operate where aerosol (spray) products are being used or where oxygen is being administered.
- To disconnect, turn all controls to the off (“0”) position, then remove plug from outlet.
- Do not unplug by pulling on cord. To unplug, grasp the plug, not the cord.
- The foot control is used to operate the machine. Avoid placing other objects on the foot control.
- Do not use the machine if it is wet.
- If the LED lamp is damaged or broken, it must be replaced by the manufacturer or its service agent or a similarly qualified person, in order to avoid a hazard.
- If the supply cord connected with the foot control is damaged, it must be replaced by the manufacturer or its service agent or a similarly qualified person, in order to avoid a hazard.
- This sewing machine is provided with double insulation. Use only identical replacement parts. See instructions for Servicing of Double-Insulated Appliances.

SAVE THESE INSTRUCTIONS

FOR EUROPE ONLY:

This appliance can be used by children aged from 8 years and above and persons with reduced physical, sensory or mental capabilities or lack of experience and knowledge if they have been given supervision or instruction concerning use of the appliance in a safe way and understand the hazards involved. Children shall not play with the appliance. Cleaning and user maintenance shall not be made by children without supervision.

The noise level under normal operating conditions is less than 75dB(A).

The machine must only be used with foot control of type “FR5” manufactured by Shanghai Binao Precision Mould Co., Ltd.

FOR OUTSIDE EUROPE:

This sewing machine is not intended for use by persons (including children) with reduced physical, sensory or mental capabilities, or lack of experience and knowledge, unless they have been given supervision or instruction concerning use of the sewing machine by a person responsible for their safety. Children should be supervised to ensure that they do not play with the sewing machine.

The noise level under normal operating conditions is less than 75dB(A).

The machine must only be used with foot control of type “FR5” manufactured by Shanghai Binao Precision Mould Co., Ltd.

SERVICING OF DOUBLE INSULATED PRODUCTS

In a double-insulated product, two systems of insulation are provided instead of grounding. No ground means is provided on a double-insulated product, nor should a means for grounding be added to the product. Servicing of a double-insulated product requires extreme care and knowledge of the system and should be done only by qualified service personnel. Replacement parts for a double-insulated product must be identical to those parts in the product. A double-insulated product is marked with the words ‘DOUBLE INSULATION’ or ‘DOUBLE INSULATED’.

TABLE OF CONTENTS

Getting to know your machine 1:5

MACHINE OVERVIEW 1:6

Rear Side 1:6

Needle Area..... 1:6

Accessory Box 1:7

ACCESSORIES 1:7

Included Accessories 1:7

Accessories Included - Not in the Picture 1:7

Presser Feet 1:8

STITCHES 1:10

ALPHABETS 1:21

Set Up 2:1

UNPACKING 2:2

Connecting the foot control cord..... 2:2

Connect the power cord and foot control 2:2

PACK AWAY AFTER SEWING 2:3

FREE ARM 2:3

USB PORT 2:3

Connect to and remove from USB port..... 2:3

SPOOL PINS 2:4

Horizontal Position..... 2:4

Vertical Position..... 2:4

Auxiliary Spool Pin 2:4

THREADING THE UPPER THREAD 2:5

NEEDLE THREADER 2:5

THREADING FOR TWIN NEEDLE 2:6

THREAD CUTTER 2:6

THREAD SENSOR 2:6

BOBBIN WINDING 2:7

Bobbin Winding Through the Needle..... 2:7

Winding Specialty Threads 2:7

CHANGING THE NEEDLE PLATE 2:8

INSERTING THE BOBBIN 2:8

CHANGING THE PRESSER FOOT 2:8

CHANGING THE NEEDLE 2:9

NEEDLES 2:9

THREADS 2:10

STABILIZERS 2:10

PICTOGRAM™ PEN 2:10

HOW TO UPDATE YOUR MACHINE 2:11

Update instructions..... 2:11

Settings & functions 3:1

FUNCTION BUTTONS 3:2

Speed + and -..... 3:2

Selective Thread Cutter 3:2

Needle Stop Up/Down..... 3:2

STOP..... 3:2

FIX 3:3

Sensor Foot Up and Extra Lift 3:3

Start/Stop..... 3:3

FUNCTION BUTTONS 3:3

Sensor Foot Down and Pivot..... 3:3

Reverse..... 3:3

EXCLUSIVE SENSOR SYSTEM™ 3:3

OVERVIEW TOUCH AREA 3:4

Quick Help..... 3:4

Save to My Stitches/My Files..... 3:4

Delete..... 3:4

Mirror end-to-end/mirror side-to-side..... 3:4

ALT and function arrows 3:4

Exclusive *SEWING ADVISOR*™ 3:4

COLOR TOUCH SCREEN 3:5

Start Menu..... 3:5

Toolbar..... 3:5

SET MENU 3:6

Machine Settings..... 3:6

Stitch Settings 3:7

Sewing Settings 3:8

Frequently used icons..... 3:8

Sewing 4:1

TABS 4:2

Stitch menu tab..... 4:2

Sewing Information Tab 4:3

Stitch altering 4:5

ALT and function arrows 4:5

EXCLUSIVE SEWING ADVISOR™ FEATURE 4:7

Fabric Selection 4:7

Sewing Techniques 4:8

SEWING TECHNIQUES 4:9

Seam 4:9

Overcast..... 4:10

Seam and Overcast..... 4:11

Seam/Overcast for Ribbing 4:11

Baste 4:12

Blind Hem 4:12

Hem..... 4:13

Perfectly Balanced Sensor

One-Step Buttonhole 4:14

Manual Buttonhole 4:15

Manual Bartack..... 4:15

Special Sewing Techniques 4:16

Decorative Tapering Stitches..... 4:17

Free Motion Quilting..... 4:17

Free Motion Stippling..... 4:18



Program	5:1
PROGRAM	5:2
EDIT YOUR STITCH OR LETTERING PROGRAM	5:3
Tabs in Program mode.....	5:3
Stitch program commands.....	5:3
SEWING A STITCH PROGRAM	5:4
SAVE TO MY STITCHES	5:4
TO RE-LOAD A STITCH PROGRAM	5:5
File Manager	6:1
FILE MANAGER	6:2
AVAILABLE MEMORY	6:2
BROWSE FILE MANAGER	6:3
List/Thumbnail View.....	6:3
MY FILES	6:3
USB	6:3
Open a Folder.....	6:3
Move Up One Folder Level.....	6:3
ORGANIZE	6:4
Create a New Folder.....	6:4
Move a File or Folder	6:4
Copy a File or Folder.....	6:4
Rename a File or Folder.....	6:4
Delete a File or Folder	6:4
FILE MANAGER POP-UP MESSAGES	6:4
Maintenance	7:1
CLEANING THE MACHINE	7:2
TROUBLESHOOTING	7:3



1 GETTING TO KNOW YOUR MACHINE

This section of the User's Guide will give you an overview of your machine, its accessories and stitches.

MACHINE OVERVIEW

1. Lid
2. Pre-Tension Thread guide
3. Thread tension discs
4. Thread take-up lever
5. Thread slots
6. Thread tension disc for bobbin winding
7. Thread cutter
8. LED-lights
9. Needle plate
10. Bobbin cover
11. Button ruler and built-in tape measure
12. Base plate
13. Function button panel
14. Main spool pin
15. Bobbin winding thread guide
16. Auxiliary spool pin
17. Bobbin stop
18. Thread cutter for bobbin winding
19. Bobbin winder spindle
20. Handwheel
21. Interactive Color Touch Screen
22. Built-In USB port
23. Stylus holder
24. ON/OFF switch, connectors for power cord and foot control

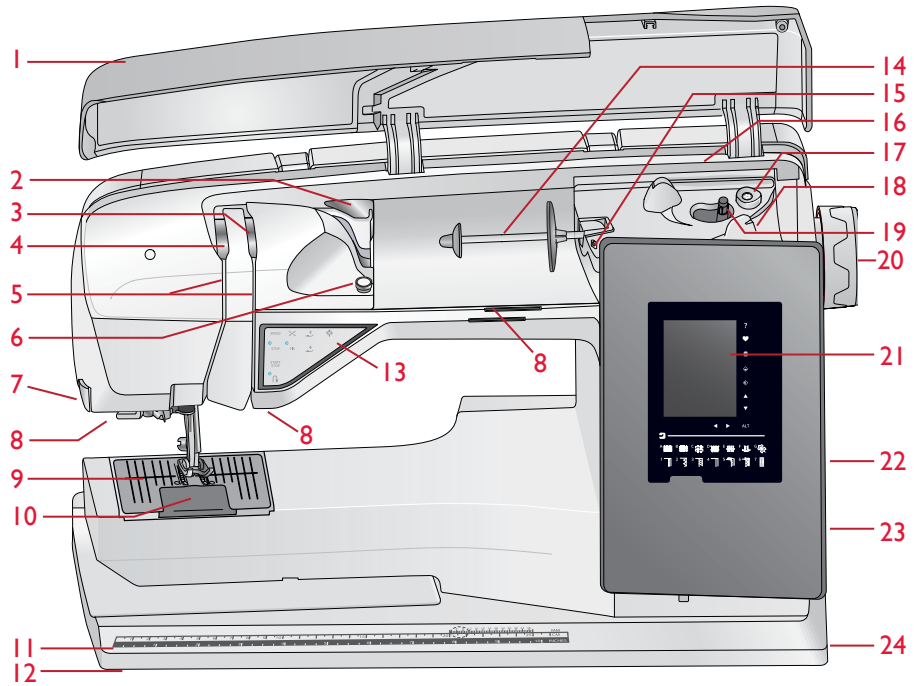

REAR SIDE

25. Handle
26. Free arm

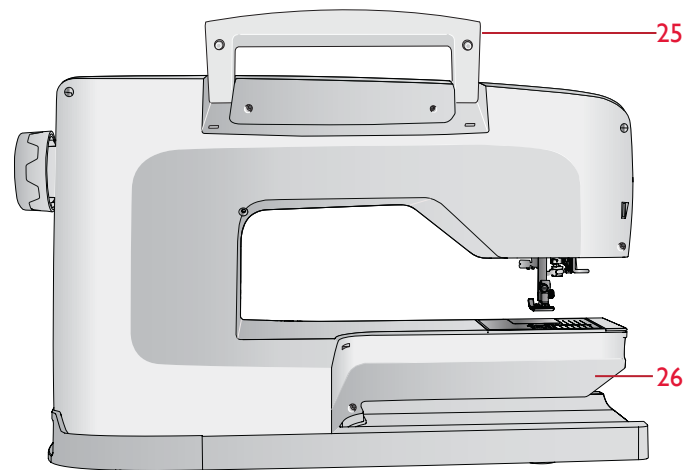

NEEDLE AREA

27. Sensor One-Step Buttonhole Foot socket
28. Built-In needle threader
29. Needle bar
30. Needle clamp
31. Needle thread guide
32. Presser foot bar and presser foot ankle
33. Presser foot

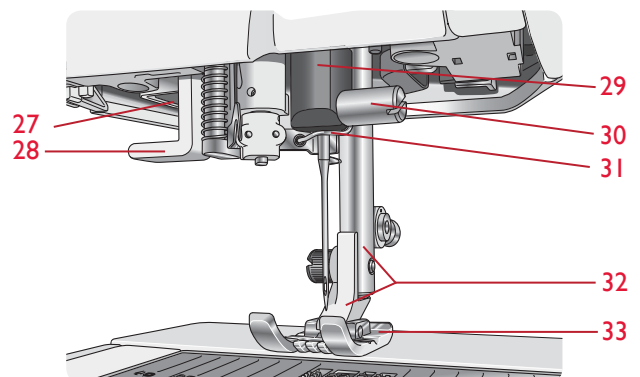

ACCESSORY BOX

The accessory box features special compartments for presser feet and bobbins, plus space for needles and other accessories. Store the accessories in the box so they are easily accessible.

- 34. Space for accessories
- 35. Removable presser feet and bobbin tray
- 36. Removable bobbin holder
- 37. Holes for needles

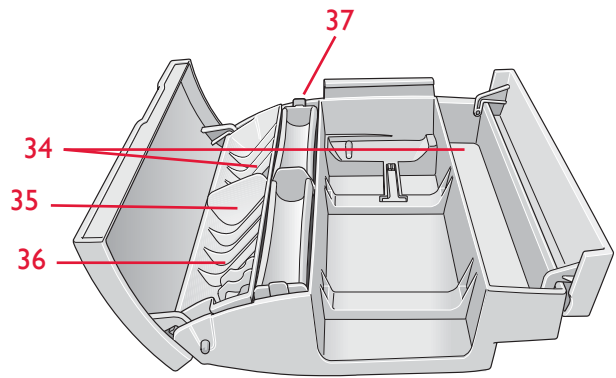

ACCESSORIES

INCLUDED ACCESSORIES

- 38. Stylus
- 39. Thread net (2)
- 40. Felt pad (2)
- 41. Screwdriver
- 42. Seam ripper
- 43. Brush
- 44. Edge/Quilting guide
- 45. 2 spool caps, large
(1 attached on the machine at delivery)
- 46. Spool cap, medium
(attached on the machine at delivery)
- 47. Spool cap, small
- 48. Multipurpose tool/Button reed
- 49. 6 Bobbins (1 in machine at delivery)
- 50. Straight stitch plate

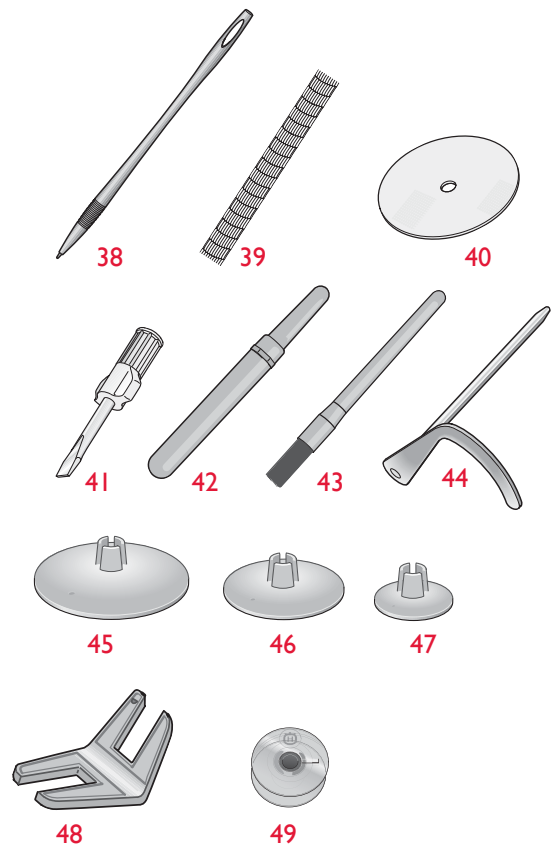

ACCESSORIES INCLUDED - Not in the Picture

- Carrying Case (attached on the machine upon delivery)
- Foot control
- Power cord
- Needles
- Thread
- Warranty card

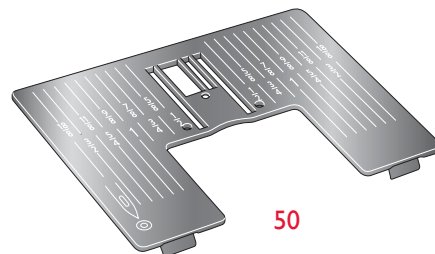

PRESSER FEET

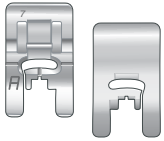

Utility Foot A

Snapped onto the machine upon delivery. This foot is used mainly for straight stitching and zigzag stitching with a stitch length longer than 1.0.

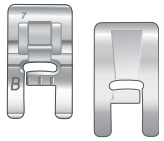

Decorative Stitch Foot B

Use this foot for sewing close zigzag stitches (satin stitches) with less than 1.0 mm stitch length and decorative stitches. The tunnel on the underside of the foot is designed to feed smoothly over the stitches.

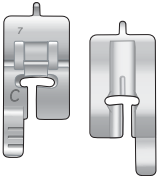

Buttonhole Foot C

For manual buttonholes. This foot has guide lines to determine buttonhole length. The middle measures a $\frac{5}{8}$ " (15 mm) from the fabric edge. The two tunnels on the underside of the foot ensure a smooth feed over the buttonhole columns. The finger on the back of the foot holds cording for corded buttonholes.

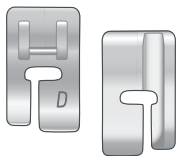

Blindhem Foot D

This foot is used for blindhem stitches. The inner edge of this foot guides the fabric. The right toe of the foot is designed to ride along the hem edge.

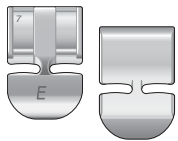

Zipper Foot E

This foot can be snapped on either to the right or to the left of the needle. This makes it easy to sew both sides of the zipper. Move needle position to right or left to sew closer to zipper teeth or for covering large cording.

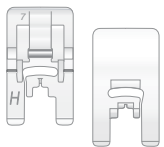

Non-Stick Glide Foot H

This foot has a non-stick coating on the underside. It is used when sewing foam, vinyl, plastic or leather to keep the material from sticking to the foot.

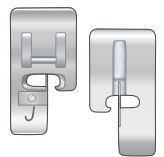

Edging Foot J

This foot is used for overcasting and seam/overcasting, with stitches that have a stitch width of 5.0 and 5.5 mm. Stitches form over the pin which prevents puckering at the edge of the fabric.

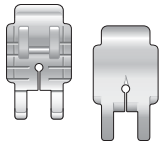

Quilter's 1/4" Piecing foot P

This foot is used when piecing quilt blocks. The foot has distance guideline marks 1/4" (6 mm) and 1/8" (3 mm) from the needle.



Clear Open Toe Foot

For satin stitch applique, taper stitches and decorative stitches. The tunnel on the underside of the foot feeds smoothly over the stitches and the transparent foot with open front provides greater visibility for accuracy.

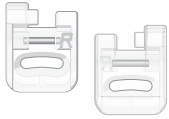

Embroidery/Darning Foot R

This foot is used for free motion embroidery/quilting/stitching and hoop embroidery.

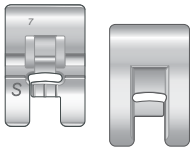

Side Motion Foot S

This foot is used for side-motion/Omnimotion stitches.

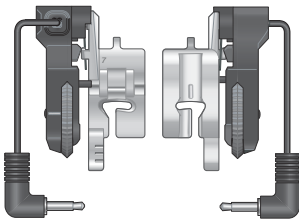

Sensor One-Step Buttonhole Foot

Plug into the machine then enter the desired buttonhole length to sew Sensor One-Step Buttonholes. The middle mark measures a 5/8" (15 mm) from fabric edge.





















Self-Adhesive Glide Plates



















Used for Presser Foot C/Sensor One-Step Buttonhole Foot when sewing buttonholes on plastic-coated fabrics, leather, etc.





STITCHES

A – Utility Stitches

Stitches for garment sewing and mending.

Stitch	Stitch no.	Stitch name	Presser Foot	Application
	1	Straight Stitch, center needle position	A	For all types of sewing. Select 29 different needle positions.
	2	Straight stitch with reinforced tie-off	A	For all types of sewing. Begins and ends with forward and reverse stitches.
	3	Stretch Stitch, left needle position	A/B	For seams in tricot and stretch fabric.
	4	Zigzag	A/B	For appliqué work, lace edging, sewing on bands etc. Stitch width increases equally to the left and right.
	5	Reinforced Straight Stitch, center needle position	A/B	For seams which are subject to considerable strain. Triple stitched for reinforcement. Use to reinforce and topstitch sportswear and work out clothes. For topstitching, increase the stitch length and move the needle to any of 29 positions.
	6	Reinforced Zigzag	A	For joining fabric edge to edge or overlapping on leather. For decorative sewing.
	7	Seam/overcast stitch	J	Seam and overcast edges in one step. For light stretch and non-stretch fabrics.
	8	Stretch Seam Overcast Stitch	A/B	Seam and overcast edges in one step. For medium and medium/heavy stretch fabrics.
	9	Double Overlock Stitch	A/B	Seam and overcast edges in one step. For heavy stretch and heavy woven fabrics.
	10	Overlock Stitch	A/B	Seam and overcast edges in one step. For medium stretch fabrics.
	11	Flatlock Stitch	A/B	Use for decorative hems, overlapped seams, belts and bands. For medium/heavy stretch fabrics.
	12	Stretch Blind Hem Stitch	D	Blind hems in medium and heavy stretch fabrics.
	13	Woven Blind Hem	D	Blind hems in medium and heavy woven fabrics.
	14	Shell Edge	A/B	For edgings; sew over the edge on light stretch fabrics. Sew woven fabrics on bias.
	15	Four Step Zigzag	B	For overcasting, mending, sewing on patches and elastic. Suitable for light and medium weight fabrics.
	16	Elastic/Casing Stitch	A/B	For overlapped seams in tricot. To sew casing over narrow elastic.
	17	Serpentine stitch	A	For mending and elastic applications.
	18	Elastic Stitch or Smocking	A/B	Sew over two rows of elastic thread for elastic shirring.
	19	Bridging Stitch	A/B	For joining two pieces of fabric with finished edges and for elastic shirring.

Stitch	Stitch No.	Stitch Name	Presser Foot	Application
	20	Three Step Zigzag	B/J	For overcasting, mending, sewing on patches and elastics on loosely woven fabrics.
	21	Two-Step Zigzag	A/B	For joining two pieces of fabric with finished edges and for elastic shirring. Also suitable for sewing on lace.
	22	Bartack (manual)	A/B	Reinforce pockets, shirts openings, belt loops as well as at lower end of a zipper.
	23	Darning Stitch (forward and backward)	A/B	Darn and mend small holes in work clothes, jeans, tablecloths and more. Stitch over the hole, press reverse for continuous darning and auto stop.
	24	Darning Stitch (side to side)	A/B	For mending small tears.
	25	Reinforced Darning stitch	A	Darn and mend work clothes, jeans, tablecloths and linen towels. Stitch over hole, touch reverse for continuous darning and auto stop.
	26	Darning stitch (four-step)	A/B	A group of four stitches perfect for mending small tears. Stitch #1 and #3 are sewn in a forward motion, stitch #2 and #4 are sewn backwards. To change stitch and direction touch the reverse button. Tip: Press fusible interfacing on the wrong side before mending the tear.
	27	Belt Loop Stitch	A	For securing belt loops.
	28	Baste Stitch	A/B	For joining two pieces of fabric with a long stitch length.
	29	Zigzag Basting	A	To baste, press the foot control and the machine will make two stitches, stop and raise the foot. When the presser foot lifts, move the fabric to the next baste position and press the foot control. Feed teeth lowered automatically.
	30	Bartack Buttonhole	Sensor Buttonhole foot/ C	Standard buttonhole for most fabric weights.
	31	Round End Buttonhole	Sensor Buttonhole foot/C	For blouses and children's garments.
	32	Keyhole Buttonhole	Sensor Buttonhole foot/C	For tailored jackets, coats, etc.
	33	Tapered keyhole buttonhole	Sensor Buttonhole foot/C	Tapered end for tailored garments.
	34	Decorative fashion buttonhole	Sensor Buttonhole foot/C	For most fabric weights.
	35	Heavy Duty Buttonhole	Sensor Buttonhole foot/C	With reinforced bartacks.
	36	Medium Reinforced Buttonhole	C	For medium and heavy fabrics.
	37	Heirloom Buttonhole	Sensor Buttonhole foot/C	For "hand look" on fine and delicate fabrics. Tip: For jeans buttonholes, increase length and width of the buttonhole. Use thicker thread.
	38	Rounded Heirloom Buttonhole	Sensor Buttonhole foot/C	For hand look on fine and delicate fabrics.

Stitch	Stitch No.	Stitch Name	Presser Foot	Application
	39	Leather Straight Stitch Buttonhole	A/B	For leather and suede.
	40	Bound Buttonhole (Straight Stitch)	A/B	With extra cutting space for bound buttonholes.
	41	Automatic Button Sewing	No presser foot	For sewing on buttons. Set the number of stitches on the TouchScreen.
	42	Eyelet	B	For belts, laces, etc.

A - Utility

Stitches for garment sewing and mending.

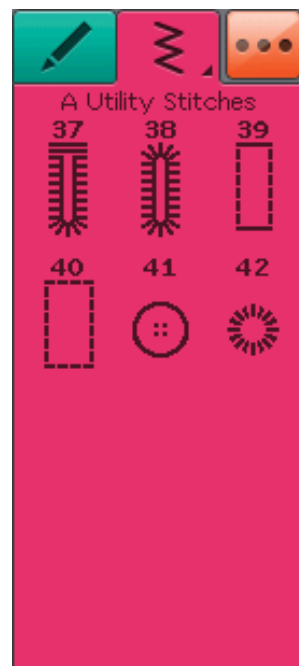
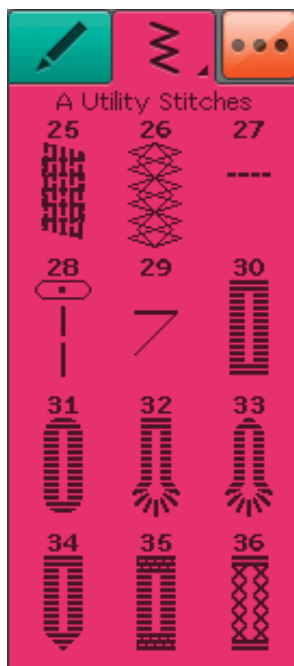
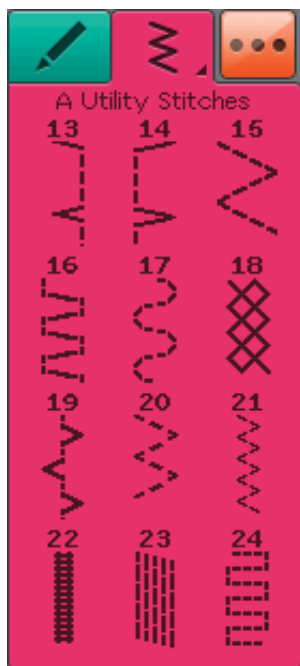
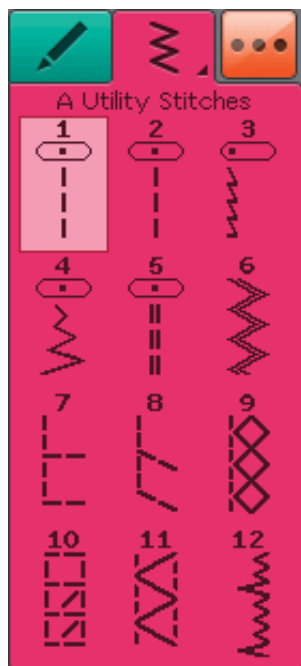

B - Appliqué Stitches

For decorative sewing and appliqué.

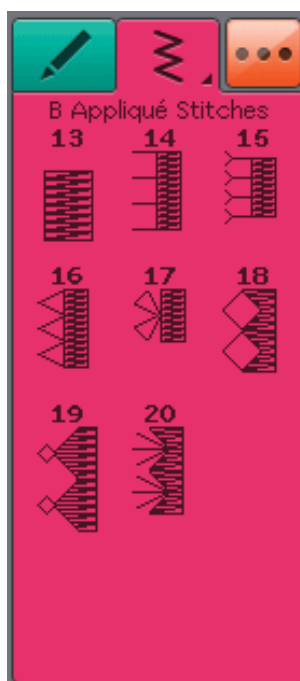
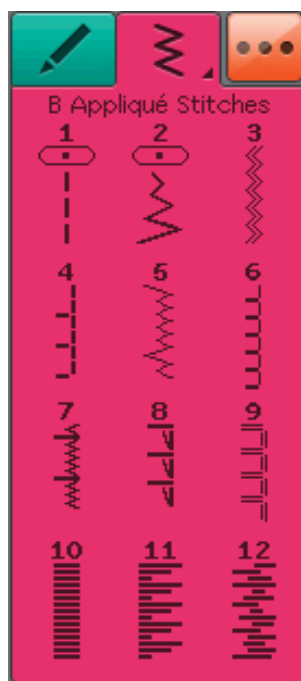

C - Heirloom Stitches

For hemstitching, smocking and sewing on lace, trims and much more. Some stitches can be used with a wing needle.

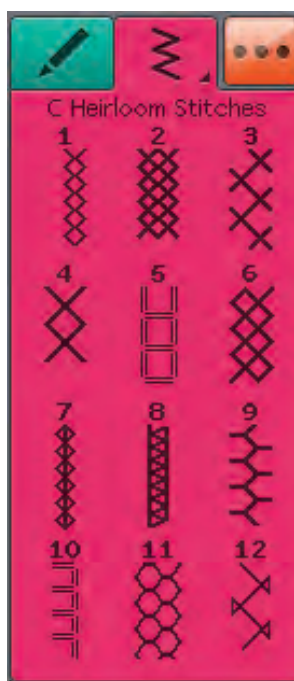

D - Quilt Stitches

Stitches for all types of quilting techniques.

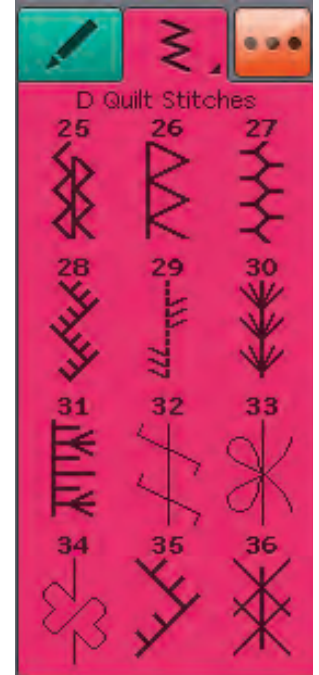
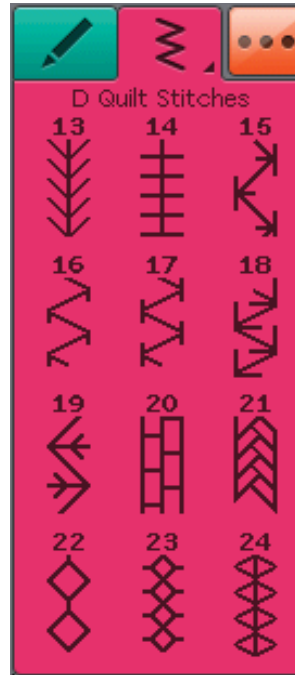
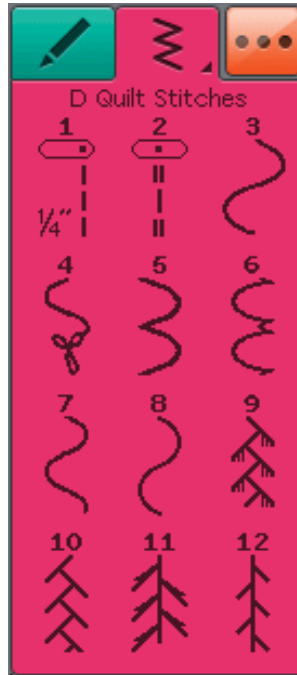
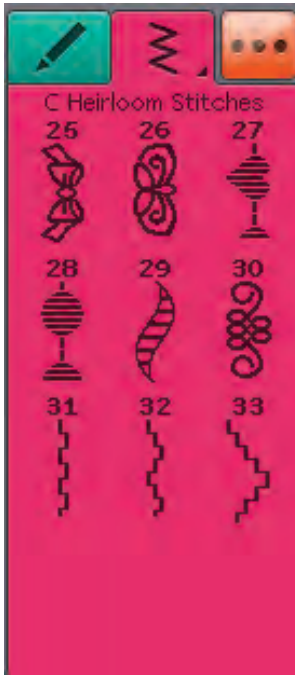

E - Crafting Stitches

Decorative stitches to embellish crafts.

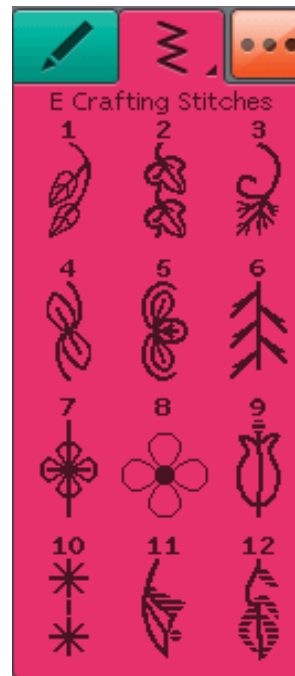

F - Decorative Stitches

For decorative sewing.

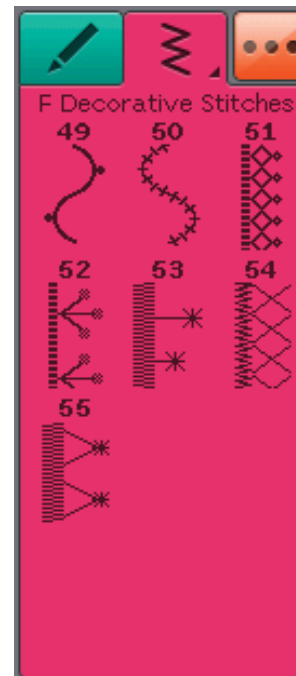
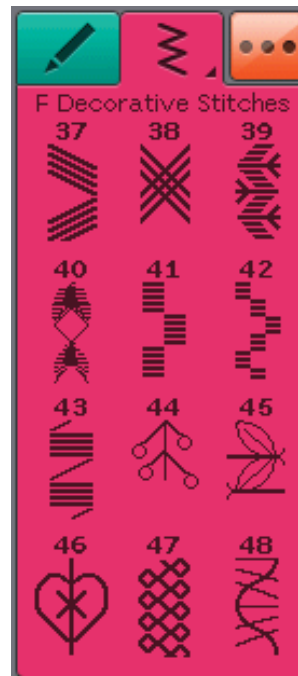
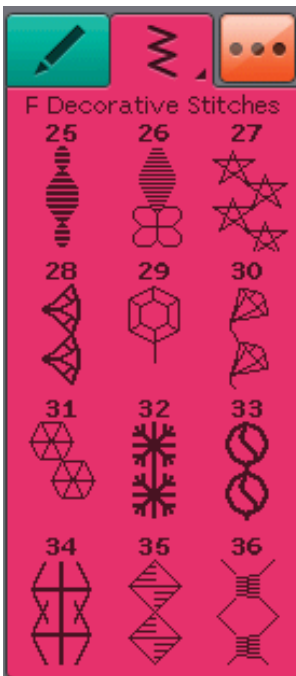
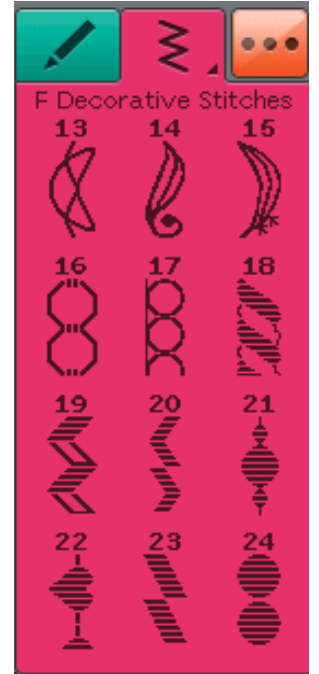
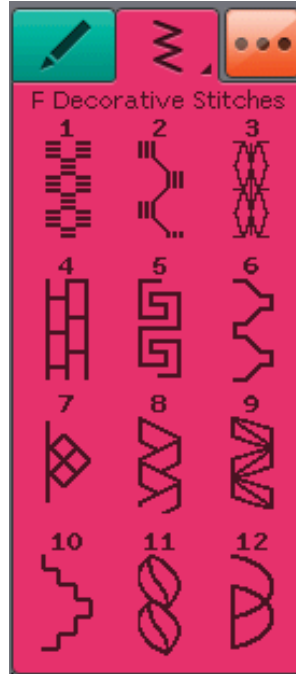
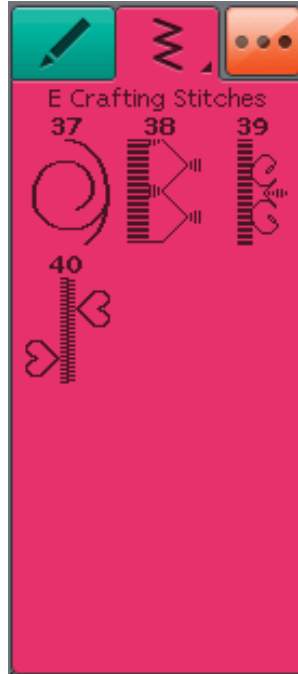
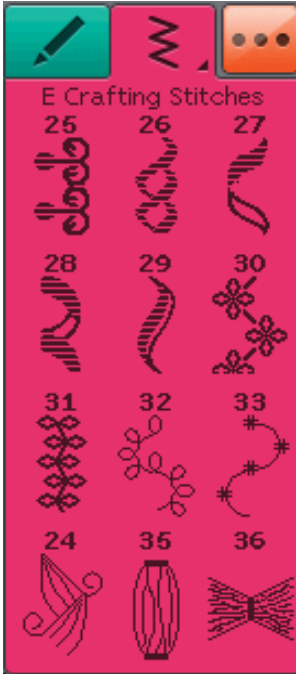

G - Vintage Stitches

A selection of quilt stitches for crazy patch quilting and decorative stitching.

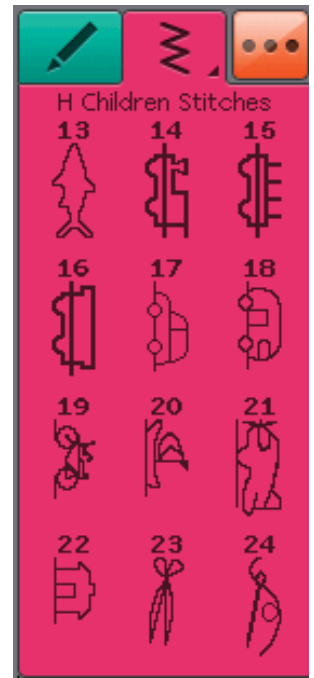
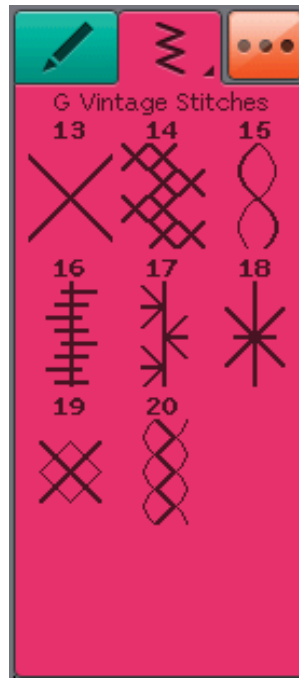
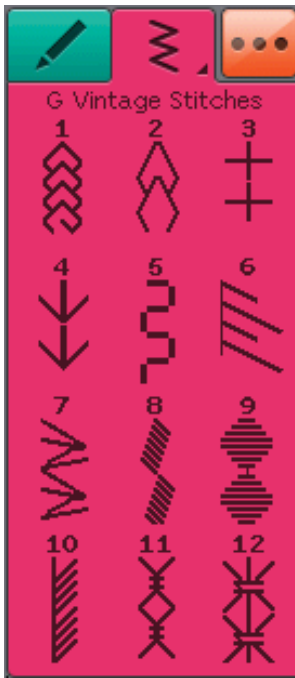

J - Scallop Stitches

Create scallop details and finish edges with beautiful scallop stitches.

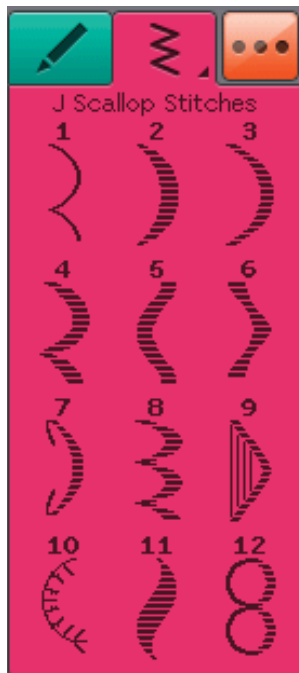
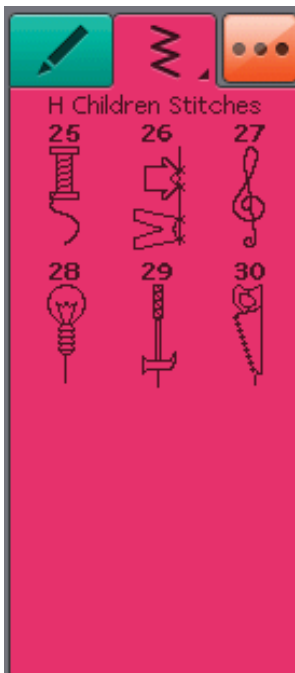

K - Omnimotion Stitches

Sew decorative sidemotion stitches with the S-foot.

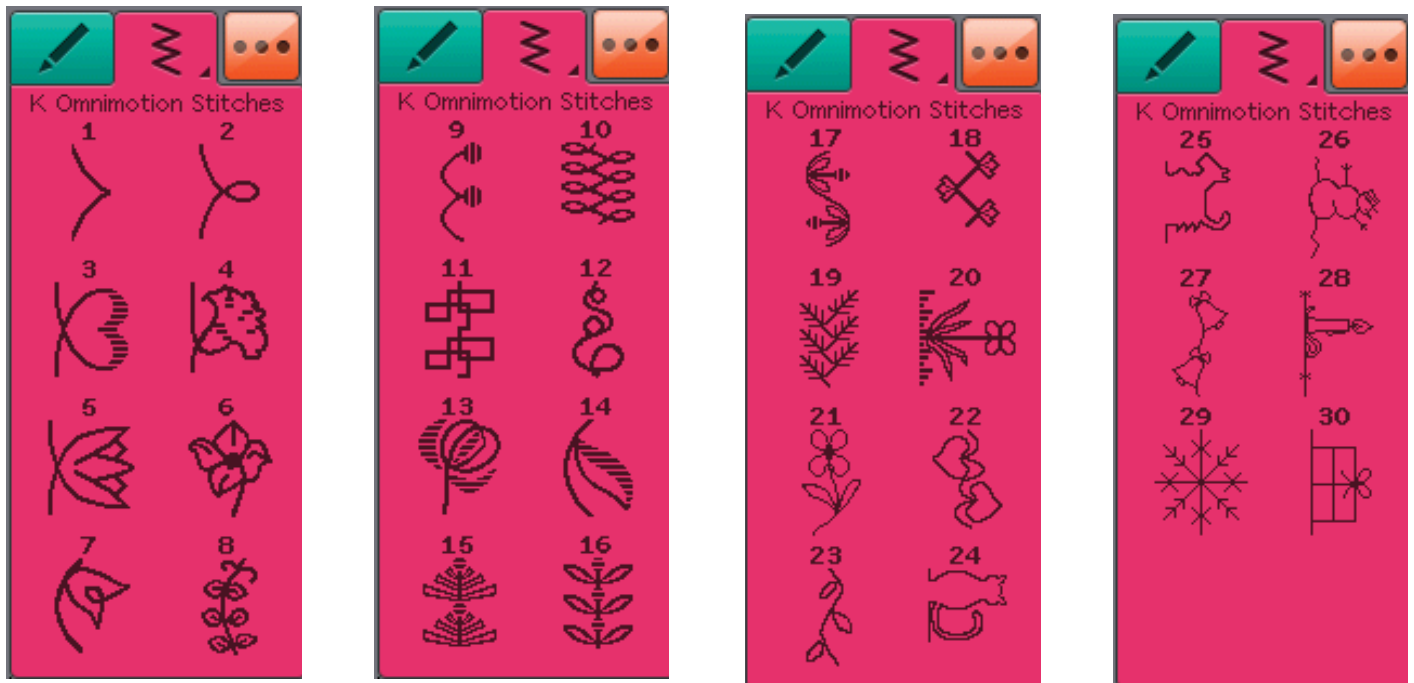

L - Dimensional Stitches

Includes three types of stitches: appliqué and pop-up stitches, combinations of these two types, and sequin stitches.

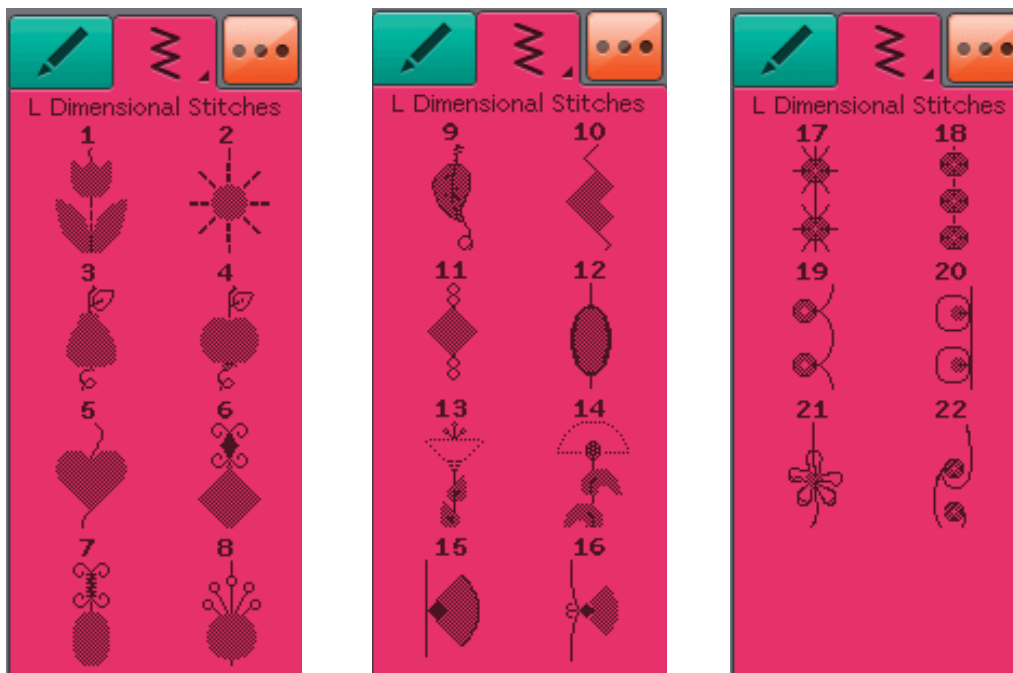

M - Theme Stitches

Each stitch number on this menu contains a group of four stitches designed to be sewn out together in random combinations. Change to the next stitch in the selected group by touching the reverse button.

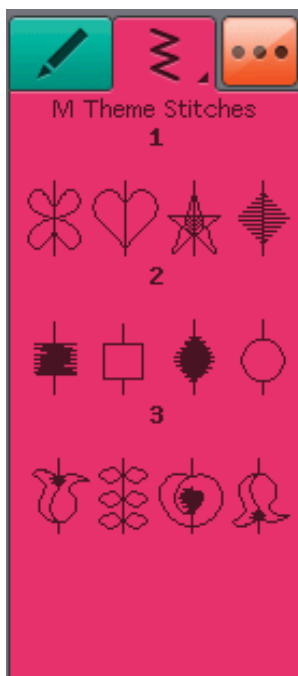

N - Embellished Stitches

Decorative stitches that can be used as they are, or further embellished after sewing. Use quick help for detailed information.

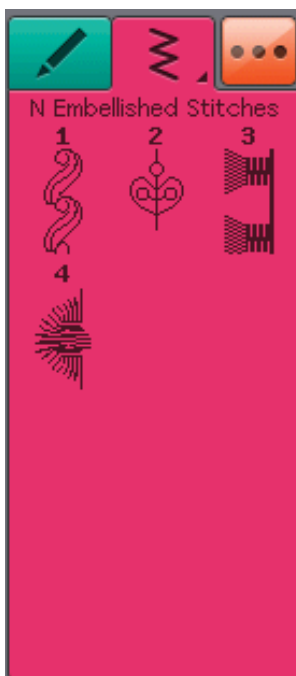

O - Single Stitches

Single stitches for embellishment. The machine stops after one sewn repetition.

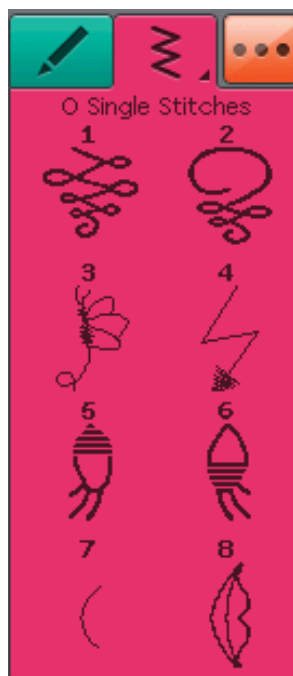

P - Specialty Stitches

Sew special techniques including candelwicking, edging and more. Extra accessories may be needed. Use quick help for detailed information.

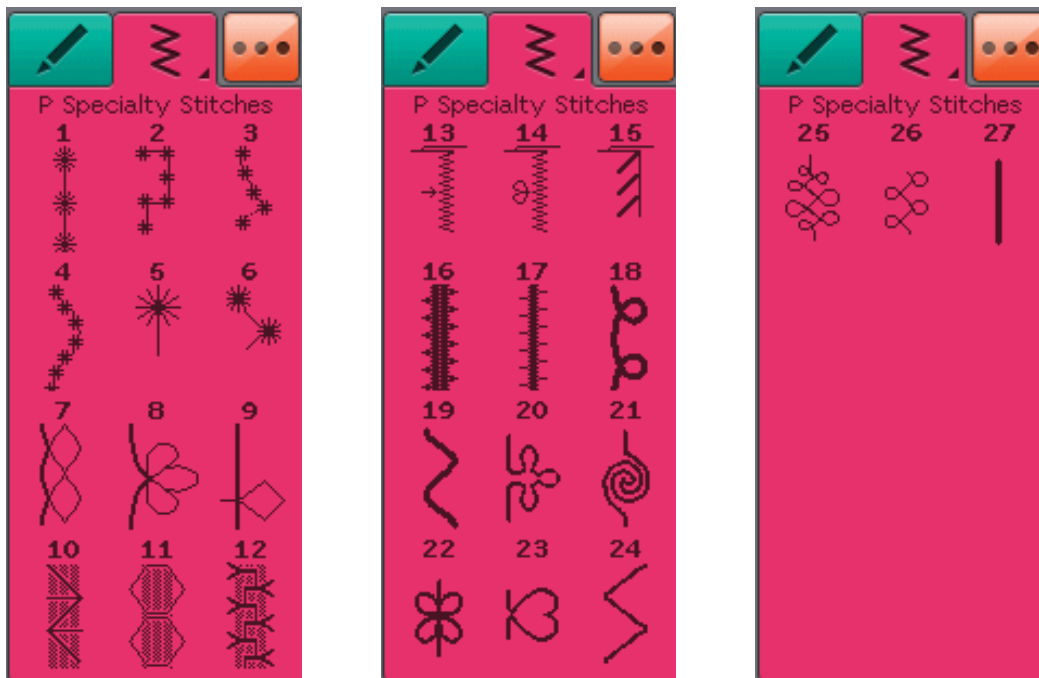

Q - Tapering Stitches

These stitches can be used for tapering.

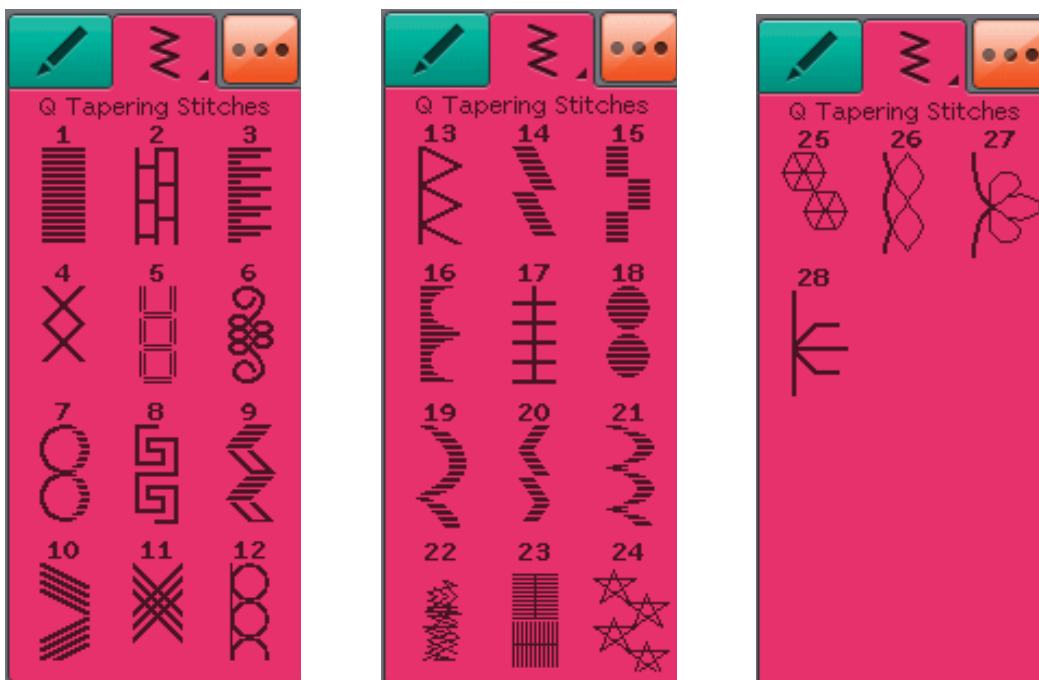

R - Pictogram Stitches

Pictogram satin elements to program original satin stitch designs.



S - 4 - Way Stitches

Four directional sewing and patching using the free arm.

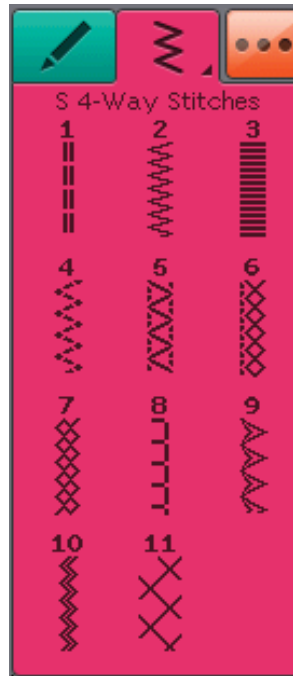

T - 8 - Way Stitches

Straight stitch and reinforced straight stitch in eight different directions without turning the fabric. Can be programmed with decorative stitches to create unique borders.

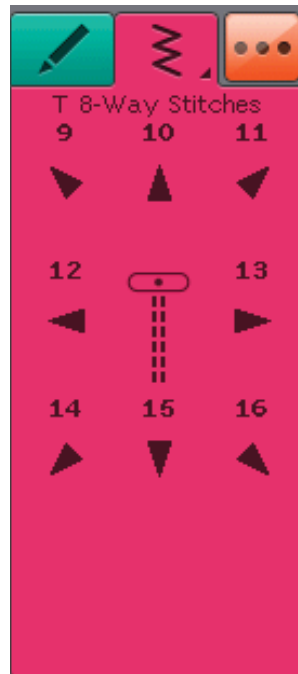
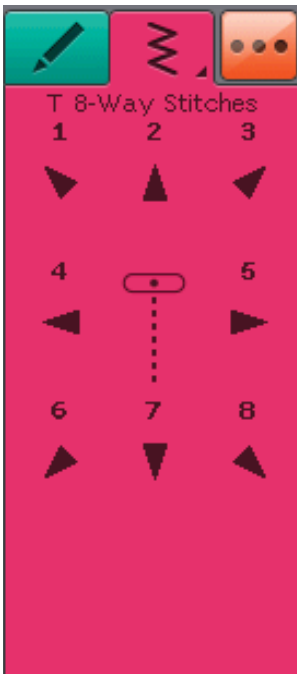

ALPHABETS

Block

ABCDEFGHIJKLMNOPQRSTUVWXYZ Ä Å Ö - _
abcdefghijklmnopqrstuvwxyz å ä ö , . _
1234567890 Æ æ Ø ø à á ç ë è é ê í ó ù ú Ñ ñ ß & ? ! ' @

Brush Line

ABCDEFGHIJKLMNOPQRSTUVWXYZ Ä Å Ö - _
abcdefghijklmnopqrstuvwxyz å ä ö , . _
1234567890 Æ æ Ø ø à á ç ë è é ê í ó ù ú Ñ ñ ß & ? ! ' @

Script

ABCDEFGHIJKLMNOPQRSTUVWXYZ Ä Å Ö - _
abcdefghijklmnopqrstuvwxyz å ä ö , . _
1234567890 Æ æ Ø ø à á ç ë è é ê í ó ù ú Ñ ñ ß & ? ! ' @

Cyrillic

For Russian alphabets, see the fonts on the Color Touch Screen of your sewing machine.



2 SET UP

This section of the User's Guide will help you get started with your machine.

Learn how to thread your machine, wind the bobbin, change needle and presser foot.

UNPACKING

1. Place the machine on a sturdy, flat surface, remove the packaging and lift off the cover.
2. Remove the packing material and the foot control.
3. The machine is delivered with an accessory bag, a power cord and a foot control cord.
4. Wipe the machine, particularly around the needle and stitch plate to remove any oil before sewing.

Note: Your HUSQVARNA VIKING® BRILLIANCE™ 75Q sewing machine is adjusted to provide the best stitch result at normal room temperature. Extreme hot and cold temperatures can affect the sewing result.

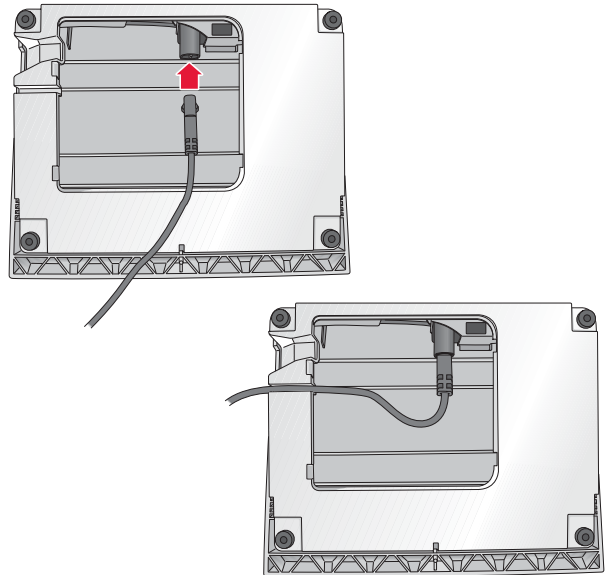

CONNECTING THE FOOT CONTROL CORD

Among the accessories you will find the foot control cord and the power cord. Connecting the foot control cord to the foot control is only necessary the very first time you are going to use the machine.

1. Take out the foot control cord. Turn the foot control over. Connect the cord to the socket inside the space of the foot control.
2. Push firmly to make sure it is properly connected.
3. Lay the cord in the slot on the underside of the foot control.

CONNECT THE POWER CORD AND FOOT CONTROL

On the underside of the machine you will find information about the power supply voltage (V) and the frequency (Hz).

Note: Before plugging in the foot control, check to ensure that it is of type "FR5" (see underside of foot control).

1. Connect the foot control cord to the front socket on the bottom right side of the machine (1).
2. Connect the power cord to the rear socket on the bottom right side of the machine (2).
3. Press the O/I switch to "I" to turn on power and light (3).

For the USA and Canada

This sewing machine has a polarized plug (one blade wider than the other). To reduce the risk of electric shock, this plug is intended to fit in a polarized outlet only one way. If the plug does not fit fully in the outlet, reverse the plug. If it still does not fit, contact a qualified electrician to install the proper outlet. Do not modify the plug in any way.

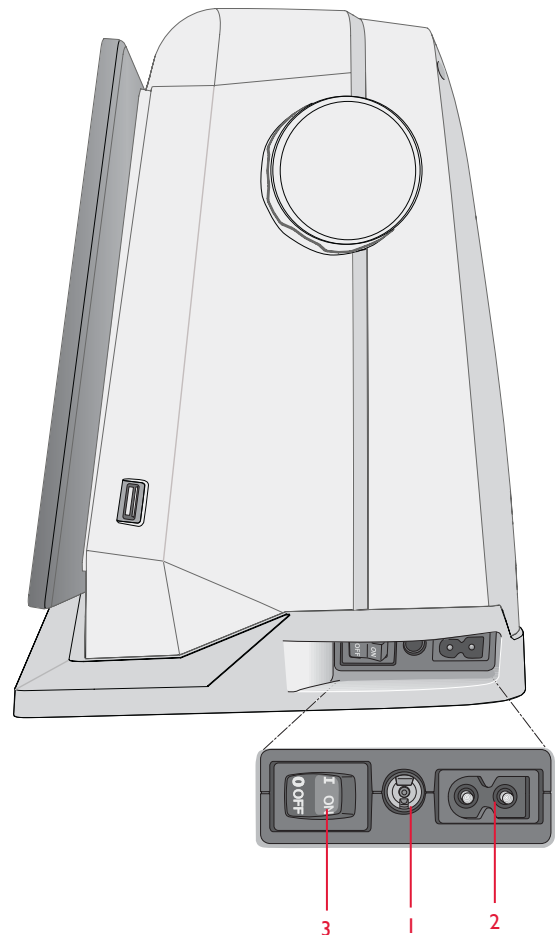

USB PORT

On the right side of your machine you will find a USB port to connect your USB stick.

Note: Make sure that the USB stick you use has the format FAT32.

CONNECT TO AND REMOVE FROM USB PORT

Insert the USB stick in the USB port on the right side of your machine. The USB plug can only be inserted one way - do not force it into the port!

To remove, carefully pull the USB stick out straight.

Note: Do not remove the USB stick while it is active.

Note: Do not remove the USB stick when the hourglass is shown on the screen or while the file manager is shown. Removing the stick at that time can damage the files on your USB stick.

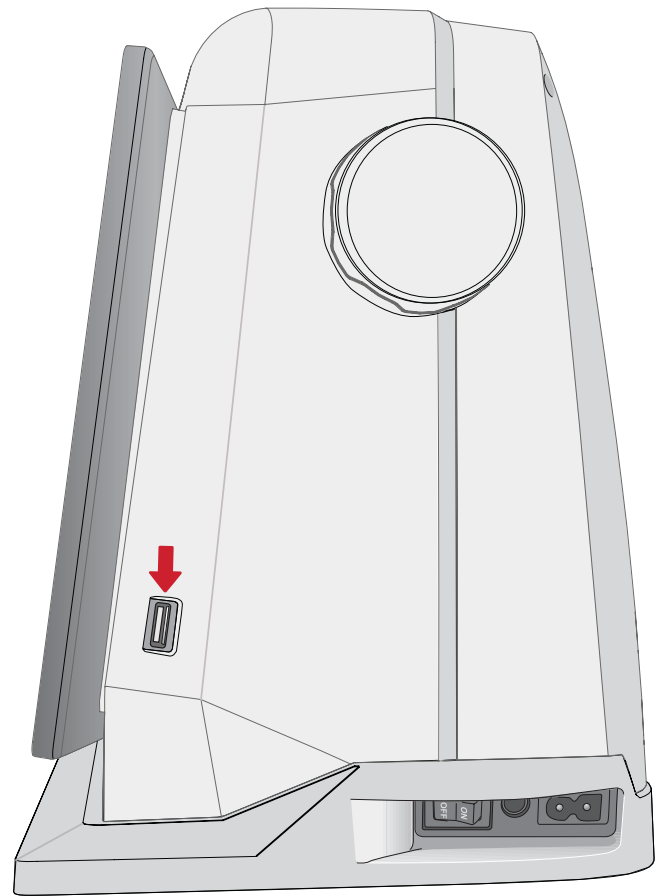

PACK AWAY AFTER SEWING

1. Press the ON/OFF (3) switch to “O”.
2. Unplug the cord from the wall socket and then from the machine.
3. Unplug the foot control cord from the machine. Wind the foot control cord and place inside the open area on the underside of the foot control.
4. Place all accessories in the accessory tray. Slide the tray on to the machine, behind the free arm.
5. Place the foot control in the space above the free arm.
6. Place the hard cover over your machine.

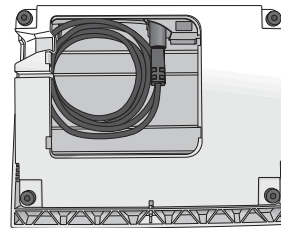

FREE ARM

Slide the accessory box to the left when you wish to remove it and use the free arm.

Use the free arm to facilitate sewing trouser legs and sleeve hems.

To replace the accessory box, slide it onto the machine until it fits in place.

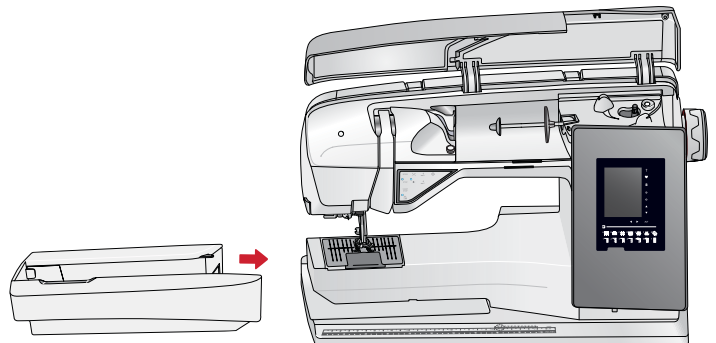

SPOOL PINS

Your machine has two spool pins; a main spool pin and an auxiliary spool pin. The spool pins are designed for all types of thread. The main spool pin is adjustable and can be used both in a horizontal position (the thread reels off the spool) and a vertical position (the thread spool rotates). Use the horizontal position for regular sewing threads and the vertical position for specialty threads.

HORIZONTAL POSITION

Place a spool cap and the thread spool on the spool pin. Make sure that the thread reels off the spool counter clockwise and slide on a second spool cap. Use a spool cap slightly larger than the thread spool.

The flat side of the spool cap should be pressed firmly against the spool. There should be no space between the spool cap and the thread spool.

Note: Not all thread spools are manufactured in the same way. If you experience problems with the thread, turn it in the opposite way or use the vertical position.

VERTICAL POSITION

Lift the spool pin up and all the way to the right. Lock the spool pin in the vertical position by slightly pressing it down. Slide on the large spool cap. For spools smaller than the medium size spool cap or when using specialty threads, place a felt pad under the thread spool to prevent the thread from reeling off too fast. For larger spools, the felt pad is not needed.

Do not place a spool cap on top of the vertical spool pin as it may prevent the spool from rotating.

Note: When the spool pin is used in the vertical position, the thread tension might need to be adjusted manually.

AUXILIARY SPOOL PIN

The auxiliary spool pin is used when winding a bobbin from a second spool of thread or for a second spool when sewing with a twin needle.

Lift the auxiliary spool pin up and to the left. Slide on the large spool cap. For spools smaller than the medium size spool cap, place a felt pad under the thread spool to prevent the thread from reeling off too fast. For larger spools, the felt pad is not needed.

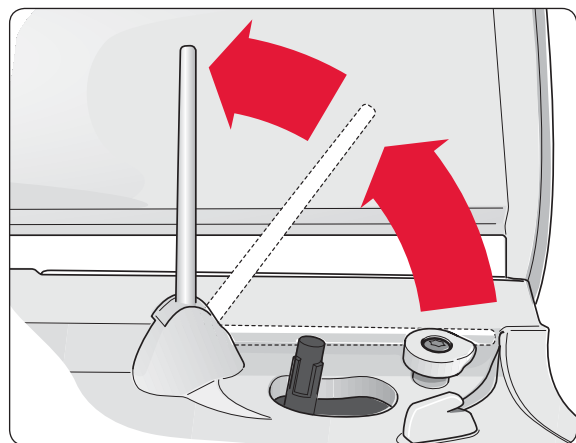
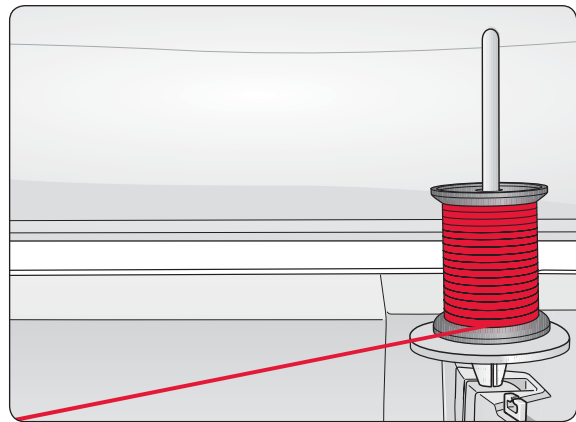
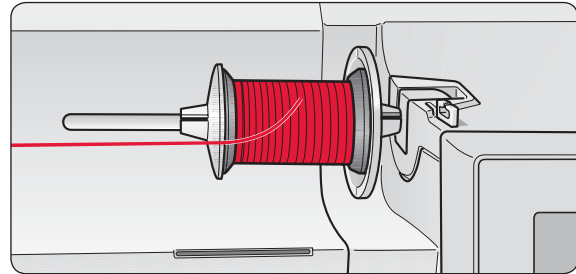

THREADING THE UPPER THREAD

Make sure that the presser foot is raised and the needle is in the up position.

1. Place the thread on the spool pin and the spool cap on the spool as described on page 2:4.
 2. **Spool pin in horizontal position:**
Bring the thread over and behind the pre-tension thread guide (A) and under the thread guide (B).
 - Spool pin in vertical position:**
Instead of bringing the thread into the pre-tension guide (A), bring it directly under the thread guide (B).
3. Bring the thread down between the thread tension discs (C).
 4. Continue threading in the direction indicated by the arrows. Bring the thread from the right into the slot on the take-up lever (D).
 5. Take the thread down and behind the last guide just above the needle (E).

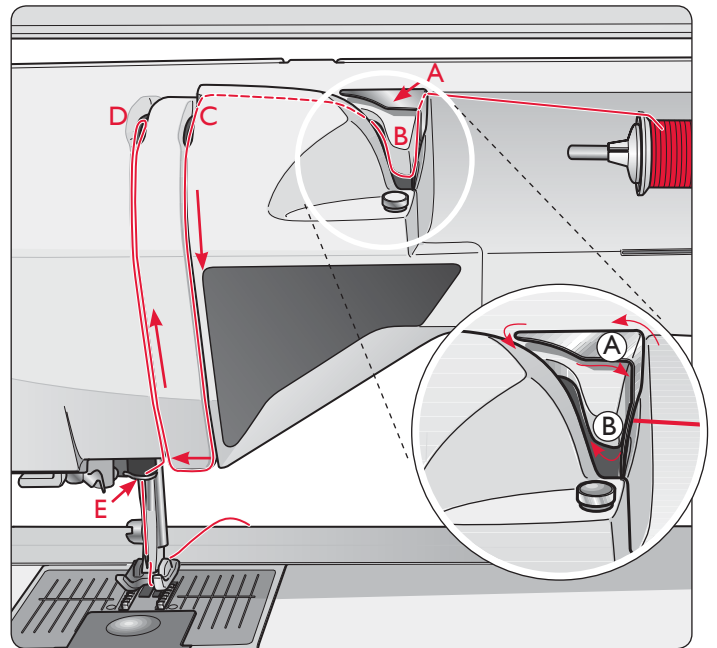

NEEDLE THREADER

The needle threader allows you to thread the needle automatically. The needle must be in the up position to use the Built-In needle threader. We also recommend lowering the presser foot.

1. Use the handle to pull the needle threader all the way down. The threader hook (G) swivels through the needle eye.
2. Place the thread from the back over the hook (F) and under the thread hook (G).
3. Let the needle threader gently swing back. The hook pulls the thread through the needle eye and forms a loop behind the needle. Pull the thread loop out behind the needle.

Note: The needle threader is designed to be used for size 70-120 needles. You cannot use the needle threader for needles size 60 or smaller, the wing needle, twin needle, triple needle or when the Sensor One-Step buttonhole foot is attached. There are also some optional accessories that require manual threading of the needle.

When threading the needle manually, make sure that the needle is threaded from front to back.

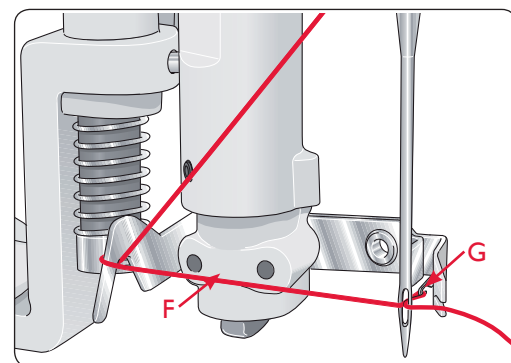
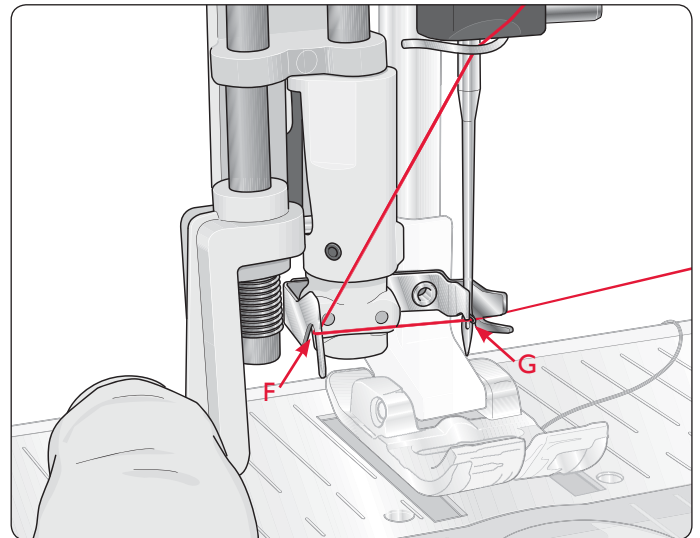

THREADING FOR TWIN NEEDLE

Replace the sewing needle with a twin needle. Make sure the presser foot is raised and the needle is in the up position.

1. Lift the spool pin up and all the way to the right. Lock the spool pin in the vertical position by slightly pressing it down. Slide on the large spool cap. For spools smaller than the medium size spool cap, place a felt pad under the thread spool.
2. Place the first thread spool on the spool pin. The spool should rotate in a clockwise direction when the thread reels off the spool.
3. **LEFT NEEDLE:** Thread the machine as described on page 2:5. Check to ensure that the thread lies between the left thread tension discs (A). Thread the left needle manually.
4. Pull out the auxiliary spool pin and slide on the large spool cap. For spools smaller than the medium size spool cap, place a felt pad under the thread spool.
5. Place the second thread on the spool pin. The second spool should rotate in a counterclockwise direction when the thread reels off the spool.
6. **RIGHT NEEDLE:** Thread the machine as before but this thread should lie between the right thread tension discs (A) and outside the needle thread guide (B). Thread the right needle manually.

Note: Activate and choose the correct needle width in Sewing Settings in SET Menu to prevent damage to the needle or the presser foot.

Note: The weight and irregular surface of specialty threads such as metallic increases the amount of friction on the thread. By reducing the tension, the risk of needle breakage is prevented.

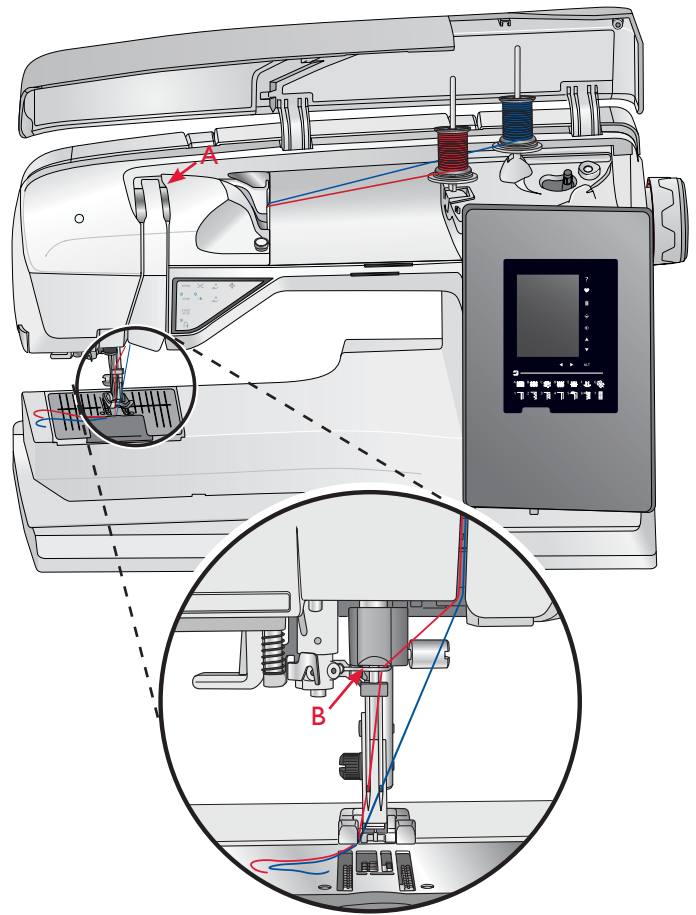

THREAD CUTTER

There are three thread cutters on your machine. The first one is close to the bobbin winder spindle (A) for cutting the thread before and after winding a bobbin. The second one is next to the bobbin area (B) for cutting the bobbin thread after placing it in the machine. The third one is on the left side of the machine (C) for manually cutting top and bobbin threads. Pull both threads into the cutter from the back to the front and pull down quickly.

THREAD SENSOR

When the bobbin thread is running low, the machine stops and a pop-up appears on the screen. Replace with a wound bobbin and continue sewing.

Note: When the bobbin thread is almost empty, the bobbin thread low pop-up appears on the screen. You can continue sewing without closing the pop-up until the bobbin thread runs out completely.

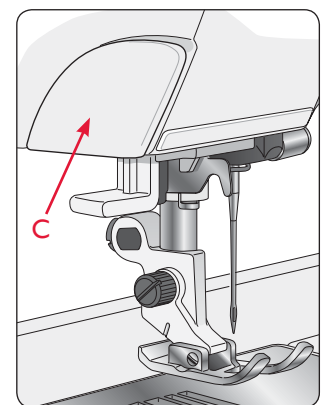
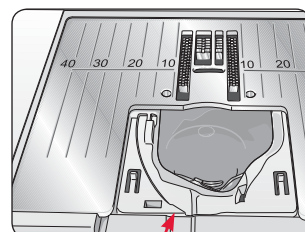
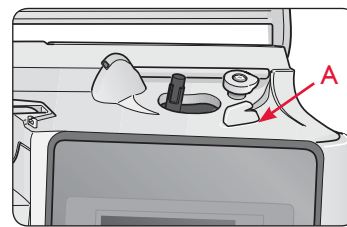

BOBBIN WINDING

BOBBIN WINDING THROUGH THE NEEDLE

Make sure that the presser foot and the needle are in the up position.

1. Place an empty bobbin on the bobbin spindle on the top of the machine. The bobbin only fits on one way, with the logo facing up. Use only original HUSQVARNA VIKING® bobbins.
2. Thread the machine with the main spool pin in the horizontal position.

Note: If the thread spool is too large to be in horizontal position, wind the bobbin as described under “Winding Specialty Threads” below.

3. Bring the thread up from the needle, under the presser foot and up to the right through thread guide (A).

Note: Use a metal presser foot when bobbin winding from the needle.

4. Guide the thread through the hole in the bobbin from the inside to the outside.
5. Push the bobbin winder spindle to the right to wind.

A pop-up appears on the screen to inform you that bobbin winding is active. To adjust winding speed, use the slider in the pop-up. Start bobbin winding by pressing the foot control or touch the start/stop.

When the bobbin is full, it will stop winding. Release the foot control or touch the start/stop button to stop the bobbin winder motor from running. Move the bobbin winder spindle to the left and the pop-up will close. Remove the bobbin and cut the thread using the bobbin thread cutter.

Note: It is important that you cut the thread end close to the bobbin.

Note: Moving the bobbin spindle to the left will engage the sewing mechanism. Always stop winding by pushing the Start/Stop button or releasing the foot control before moving the bobbin spindle.

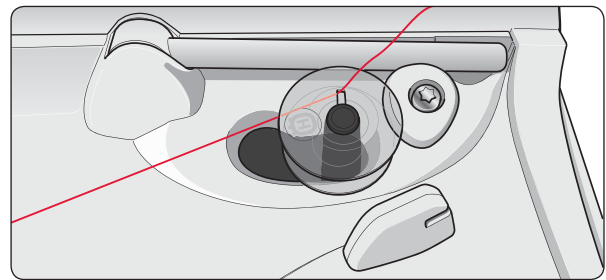
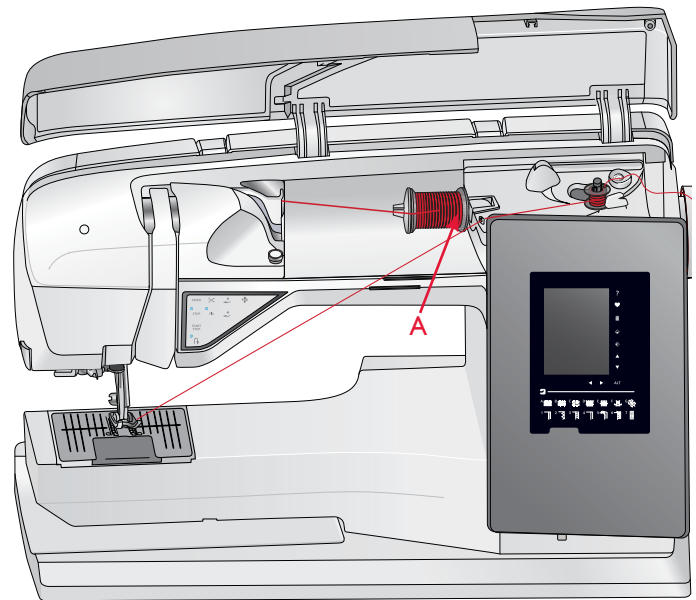

Note: When using earlier version of HUSQVARNA VIKING® bobbins that do not have a hole, wind several turns of thread on the bobbin to get started.

WINDING SPECIALTY THREADS

We do not recommend winding speciality threads such as “invisible” or other stretchy threads, metallic or flat metallic threads through the needle.

Always wind these threads at minimum speed.

1. Place an empty bobbin on the bobbin spindle at the front of the machine. The bobbin only fits on one way, with the logo facing up. Use only original HUSQVARNA VIKING® bobbins.
2. Place the large spool cap and a felt pad under the spool on the main spool pin set in the vertical position.
3. Bring the thread over the Pre-Tension Thread guide (B) and down around the thread tension disc (C), then through thread guide (D) as illustrated.
4. See Bobbin Winding Through the Needle, step 4-5.

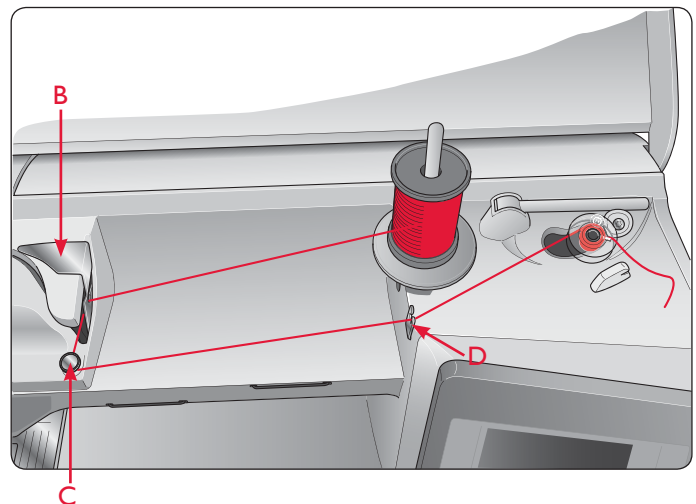

CHANGING THE NEEDLE PLATE

1. Remove the presser foot and slide off the bobbin cover.
2. Make sure that the feed teeth are lowered. Place the screwdriver under the needle plate as shown in the picture and gently turn the screwdriver to pop off the needle plate.
3. With feed teeth lowered, place the needle plate so that it fits into the notch at the back (D). Press the needle plate down until it clicks into place. Slide on bobbin cover.

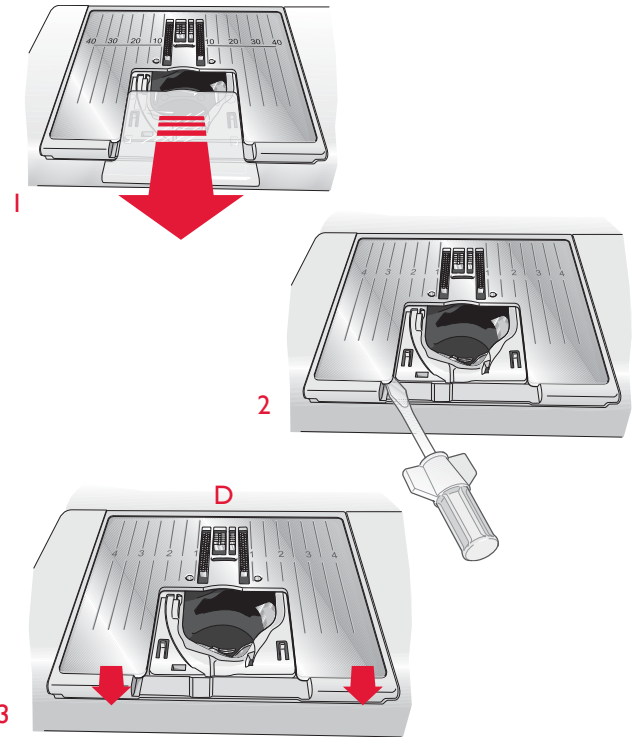

INSERTING THE BOBBIN

1. Remove the bobbin cover by sliding it towards you.
2. Place the bobbin in the bobbin case. The bobbin only drops in one way; with the logo facing up. The thread unreels from the left of the bobbin. The bobbin will then rotate counter-clockwise when you pull the thread.
3. Place your finger on the bobbin to keep it from turning as you pull the thread firmly to the right and then to the left into the tension spring (C) until it “clicks” into place.
4. Continue threading around (D) and to the right of the thread cutter (E). Slide on the bobbin cover (F). Pull the thread to the left to cut (G).

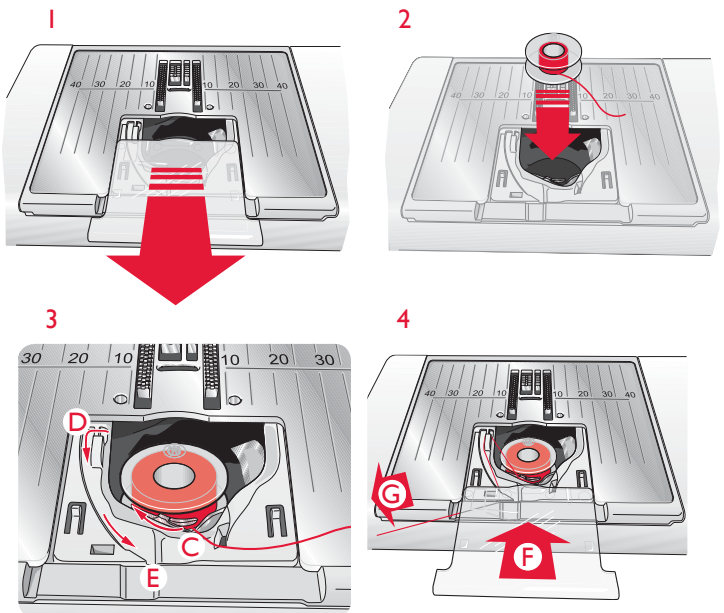

Note: The bobbin cover can be used as a magnifying glass to make threading easier.

CHANGING THE PRESSER FOOT

1. Make sure that the needle is in the highest position. Pull the presser foot down and towards you.
2. Line up the cross pin on the foot with the gap in the presser foot ankle.
3. Push the foot into the clip until the foot snaps into place.

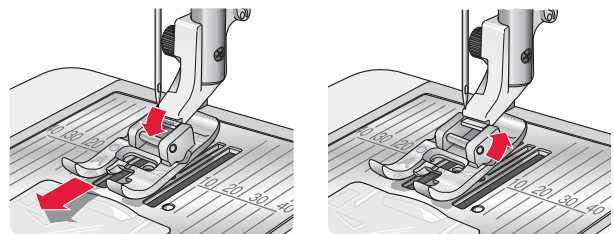

CHANGING THE NEEDLE

1. Use the hole in the multipurpose tool to hold the needle.
2. Loosen the needle screw.
3. Remove the needle.
4. Insert the new needle using the multipurpose tool. Push the new needle upwards with the flat side away from you until it will go no further.
5. Tighten the needle screw.

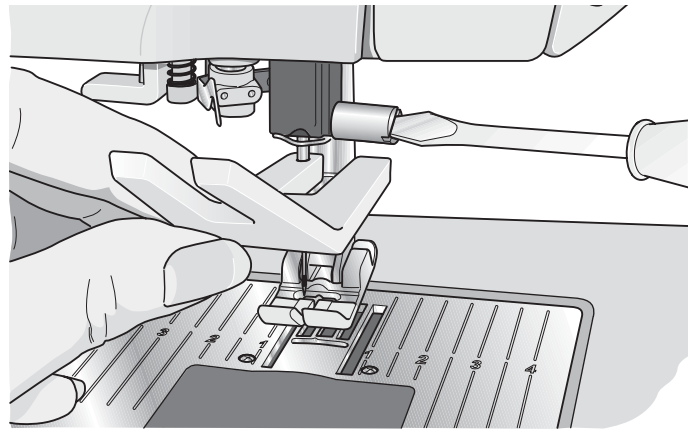

NEEDLES

The sewing machine needle plays an important role in successful sewing. Use only quality needles. We recommend needles of system 130/705H. The needle package included with your machine contains needles of the most frequently used sizes.

Universal Needle (A)

Universal needles have a slightly rounded point and come in a variety of sizes. For general sewing in a variety of fabric types and weights.

Stretch Needle (B)

Stretch needles have a special scarf to eliminate skipped stitches when there is a flex in the fabric. For knits, swimwear, fleece, synthetic suedes and leathers.

Embroidery Needle (C)

Embroidery needles have a special scarf, a slightly rounded point and a slightly larger eye to avoid damage to thread and materials. Use with metallic and other specialty threads for embroidery and decorative sewing.

Denim Needle (D)

Denim needles have a sharp point to penetrate tightly woven fabrics without deflecting the needle. For canvas, denim, microfibers.

Wing Needle (E)

The Wing needle has wide wings on the side of the needle to poke holes in the fabric when sewing entredeux and other hemstitches on natural fiber fabrics. For canvas, denim and microfibers.

Note: Change the needle often. Always use a straight needle with a sharp point (F). A damaged needle (G) can cause skipped stitches, breakage or snapping of thread. A damaged needle can also damage the needle plate.

Do not use asymmetrical twin needles (H) since they may damage your sewing machine.

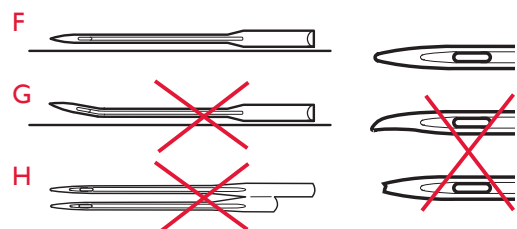
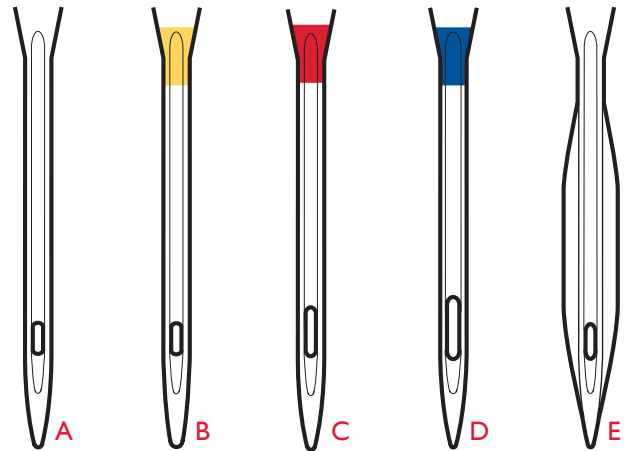

THREADS

There are many threads on the market today developed for different purposes.

All Purpose Sewing Thread

All purpose sewing thread is made of synthetic, cotton or cotton covered polyester. This type of thread is used for sewing garments and projects.

Embroidery Thread

Embroidery thread is made of various fibers: rayon, polyester, acrylic or metallic. These threads create a smooth glossy appearance for embroidery and other decorative stitching.

Transparent Thread

Transparent thread, also called monofilament thread, is single clear synthetic thread. It is used for quilting and other decorative sewing. Thread the sewing machine with the spool in the vertical position. When winding a bobbin, wind at slow speed and wind the bobbin half full.

Note: Some fabrics have excess dye which can cause discoloration on other fabrics or on your sewing machine. This discoloration may be very difficult or impossible to remove.

Fleece and denim fabric, especially red and blue, often contain excess dye.

If you suspect that your fabric/ ready-to-wear garment contains a lot of excess dye, always pre-wash it before sewing/ embroidering to prevent discoloration of your machine.



STABILIZERS

Tear-Away Stabilizers

Tear-away stabilizers are used with stable woven fabrics. Place underneath fabric for decorative stitching or hoop with the fabric when embroidering. Tear away excess stabilizer after stitching.

Iron-on Tear-Away

Iron-on tear-away is a totally stable stabilizer that has a slick side that will iron on to fabric. It is recommended for knits and all unstable fabrics. Fuse it to the wrong side of the fabric before decorative stitching or hooping. Tear away excess stabilizer after stitching.

Cut-Away Stabilizer

Cut-away stabilizer does not tear so the excess has to be cut away. It is recommended for knits and all unstable fabrics, especially for hoop embroidery.

Water Soluble Stabilizer

Water soluble stabilizer is placed on top of the fabric when embellishing/embroidering napped and looped fabrics such as terry cloth. When embroidering cutwork, use it underneath the fabric. Place your work in water to dissolve the excess stabilizer. It is available in different thicknesses.

Disintegrating Stabilizer

Disintegrating stabilizer is a stable, loosely woven fabric that is used for techniques such as cutwork and to crochet off the fabric edge. The stabilizer disappears with heat.

Sticky Stabilizer

Sticky stabilizer is used for hoop embroidery when the fabric is too delicate or too small to be hooped. Hoop the sticky stabilizer with the paper side up. Remove the paper and stick the fabric onto the sticky surface. Tear away sticky stabilizer after stitching.

PICTOGRAM™ PEN

Use an air or water soluble marking pen for embroidery and Pictograms on all types of fabrics. The color disappears after a few hours. You can also use cold water to completely remove the markings. Make sure that all markings are removed before ironing or washing with soap or detergent.

HOW TO UPDATE YOUR MACHINE

Be sure to consult the web site at www.husqvarnaviking.com and/or your local authorized HUSQVARNA VIKING® retailer for updates and upgrades for your machine and User's Guide.

UPDATE INSTRUCTIONS

1. Go to the HUSQVARNA VIKING® web site at www.husqvarnaviking.com and find your sewing machine. Here you will find updates available for your machine.
2. Download the update software to your USB stick, following the instructions on the web site.
3. Make sure that your machine is turned off. Connect the USB stick loaded with the new software version to the USB port on your machine.
4. While pressing and holding the reverse button, turn your machine on.
5. The update starts automatically and you can release the reverse button when the process bar appears.

Note: It might take up to one minute before the process bar appears and you can release the reverse button.

6. When the update is complete the machine will restart automatically. Check the software version number in the Settings Menu.





3 SETTINGS & FUNCTIONS

This section of the User's Guide will guide you through the basic settings and function buttons of your machine. Learn how to navigate the functions and settings on the Interactive Color Touch Screen and how to use the function buttons on the sewing machine head.

FUNCTION BUTTONS

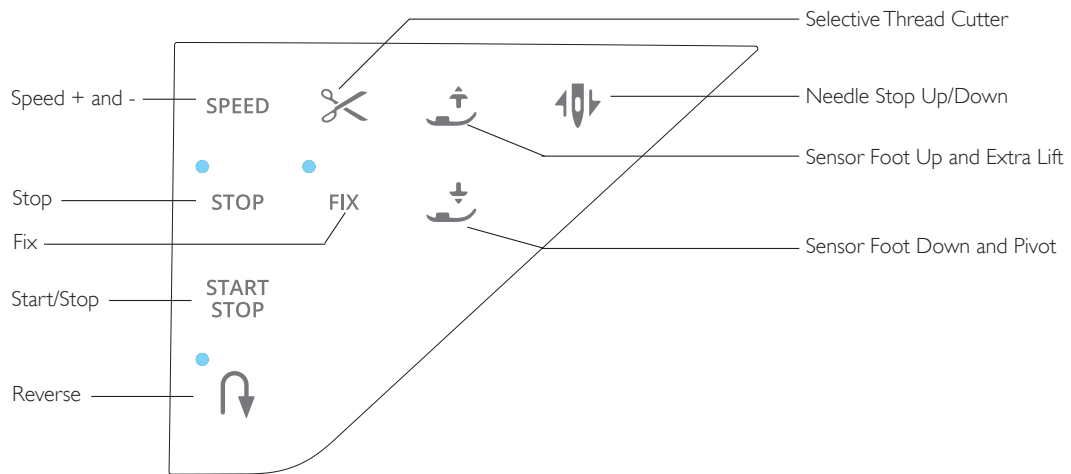

SPEED + AND -

All stitches in your machine have a pre-set, recommended sewing speed.

Touch Speed + or Speed - to increase or decrease the sewing. When touching Speed a pop-up message on the screen will indicate the speed setting. You can set the speed by touching the slider in the pop-up message. If you change the speed setting while sewing no pop-up message will appear.

When sewing with metallic threads, or when sewing on delicate fabrics, lower the speed for optimal results.

SELECTIVE THREAD CUTTER

Touch the Selective Thread Cutter button and your machine cuts the top and bobbin threads, raises the presser foot and the needle, and activates the FIX function for the next start. To cut threads at the end of a stitch or stitch program, touch Selective Thread Cutter while sewing. The button starts to flash, indicating that a cut is requested. When the stitch or stitch program is completed, the machine will make a FIX and then cut the upper thread and bobbin thread. The Selective Thread Cutter function can be programmed, see page 5:3.

NEEDLE STOP UP/DOWN

Touch the Needle Stop Up/Down to move the needle up or down. The setting of the needle stop position is changed at the same time. You can also tap the foot control to raise or lower needle without changing the Needle Stop Up/Down. The Needle Stop Up/Down button lights up when the function is active. Touch the lit button to turn the function off.

STOP

Select STOP to conclude a stitch. Your machine fixes the thread and stops automatically when one stitch or stitch program has been completed. When STOP is selected only one stitch is displayed on the Interactive Color Touch Screen. The STOP button lights up when you touch it. Select STOP again to cancel or by selecting a new stitch. The STOP button light will go out. The STOP function is cancelled when the stitch is completed. The STOP function can be programmed, see page 5:3.

FUNCTION BUTTONS

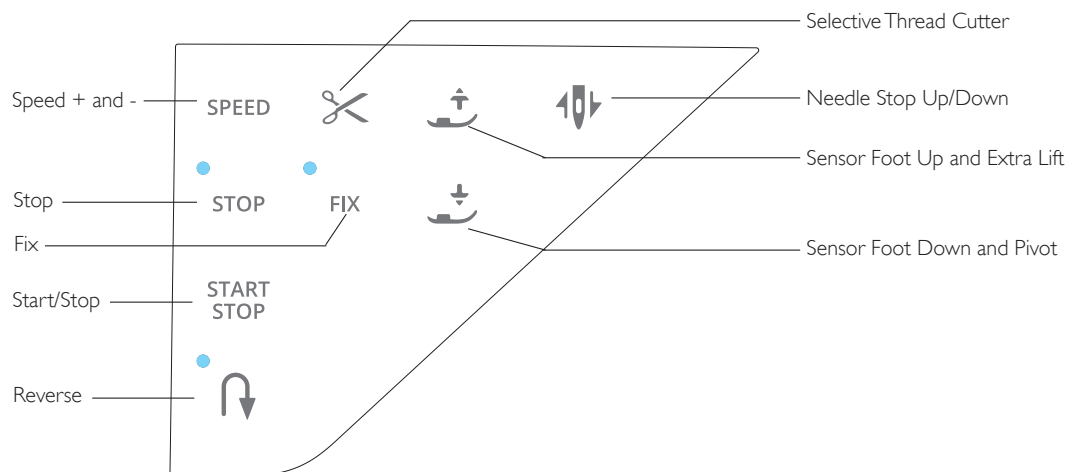

FIX

FIX is used to tie off a stitch. FIX is automatically activated when you select a stitch, use the Selective Thread Cutter, select Stitch Re-Start or use STOP while you are sewing. At the beginning, your machine sews a few tie-off stitches and continues with the selected stitch. Touch FIX while sewing and your machine sews a few tie-off stitches and stops automatically. The FIX button lights up when the FIX function is active. Touch the lit button to turn the function off. The FIX function can be programmed, see page 5:3.

Note: FIX Auto can be cancelled in the SET Menu, Sewing Settings (see page 3:8). No automatic FIX stitches will be sewn unless you use the FIX button on your machine.

SENSOR FOOT UP AND EXTRA LIFT

Touch Sensor Foot Up to raise the presser foot. Touch it a second time and the presser foot will raise to Extra Lift and lower the feed teeth.

START/STOP

Touch this button to start or stop the machine sewing when you are not using the foot control. Touch START/STOP to begin and touch again to stop.

SENSOR FOOT DOWN AND PIVOT

Touch the Sensor Foot Down and Pivot button and the presser foot will be completely lowered. The machine firmly holds the fabric. Touch Sensor Foot Down again to get the Pivot position.

REVERSE

For permanent reverse, press the Reverse button once before starting to sew. The reverse indicator will be lit and the machine sews in reverse until you press the button again to cancel. If you press the reverse button while sewing, the machine will sew in reverse for as long as you keep the button pressed. The reverse indicator is lit when the reverse button is pressed.

Reverse is also used when sewing buttonholes, darning stitches to step between the parts of the stitch and tapering stitches.

EXCLUSIVE SENSOR SYSTEM™

Thanks to the EXCLUSIVE SENSOR SYSTEM™ feature, the presser foot continuously senses the thickness of fabric when stitching and sews over it smoothly and evenly with perfect fabric feeding.

Go to the SET Menu, to see the actual setting of the Sensor presser foot pressure for the selected fabric and adjust the presser foot pressure.

OVERVIEW TOUCH AREA

The screen on your HUSQVARNA VIKING® BRILLIANCE™ 75Q is very easy to work with - just touch it with your stylus or your finger tip to make your choices. In this chapter we will describe the area outside the Color Touch Screen. This part will not change its appearance.

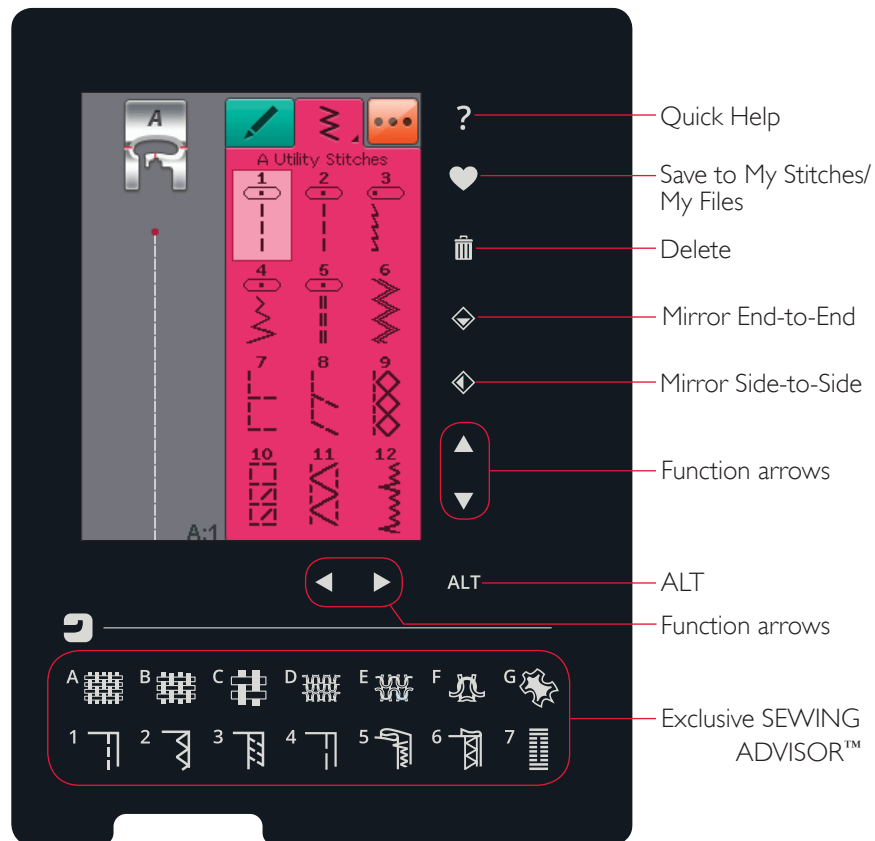

QUICK HELP

Touch the Quick Help icon in the upper right corner. A questionmark is shown on screen indicating that Quick Help is active. Touch any icon, text or area on the touch area that you want information about. A pop-up message gives a short explanation. Touch OK to close the pop-up message and exit Quick Help.

SAVE TO MY STITCHES/MY FILES

Touch the Save to My Stitches/My Files icon to open the dialogue for saving a stitch, a stitch program or an adjusted stitch.

DELETE

Touch the Delete icon if you want to delete a stitch, sequence or folder. The Delete function is active until a stitch, sequence or folder is selected and deleted or until it is touched again. If a stitch is selected to be deleted a pop-up message will ask you to confirm the deletion.

Note: If you Touch & Hold on the Delete function, you can delete all your stitches in My Stitches. You cannot delete built-in fonts or stitches.

MIRROR END-TO-END/MIRROR SIDE-TO-SIDE

To mirror stitches or stitch programs sidewise touch Mirror Side-to-Side function. For mirroring the stitch or stitch programs lengthwise touch Mirror End-to-End function.

Note: Buttonholes cannot be mirrored.

ALT AND FUNCTION ARROWS

The arrows on your touch area can change function depending on what is shown on your color touch screen. Touch the ALT icon to see if there are more functions available than shown on screen. Read more about the ALT icons specific functions in each window in chapters 4 and 5.

EXCLUSIVE SEWING ADVISOR™

Your new sewing machine has the HUSQVARNA VIKING® Exclusive SEWING ADVISOR™ feature. It is always active and is located at the bottom of the Interactive Color Touch Screen. When beginning a sewing project, touch your fabric type and weight, then touch the technique you desire.

The Exclusive SEWING ADVISOR™ feature sets the best stitch, stitch length, stitch width, sewing speed, thread tension and sensor foot pressure for your project. The stitch is displayed on screen with presser foot and needle recommendations.

COLOR TOUCH SCREEN

START MENU

Touch the Start Menu icon to open the Toolbar. The Toolbar is used for selecting and activating different windows.

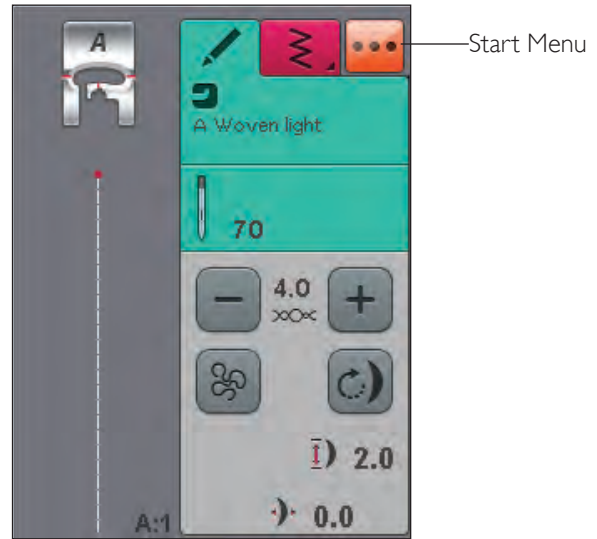

TOOLBAR

From the toolbar you will be able to enter the Stitch Menu, Font Menu, Program Mode, File Manager and SET Menu. Touch the function you want to activate.

Stitch Menu

When touching the Stitch Menu icon on the toolbar, the Stitch menus will open. Touch a stitch to select it or touch a menu to enter a certain stitch menu (see chapter 4).

Stitch Font Menu

Touch the Stitch Font Menu and a pop-up will appear with the available stitch fonts. Select a font by touching it. When a font is selected, you will automatically enter the Program mode.

Program

Touch the Program icon to go to Program window. You can combine stitches and/or letters and numbers to create stitch programs. Combine various decorative stitches and stitch fonts from the machine. You can program stitches up to approximately 500mm (20") or 99 stitches long. Read more about programming in chapter 5.

File Manager

The File Manager is used to open, organize, add, move, remove and copy your files. Use either built-in memory or an external device connected to your machine for storing files. Learn more about the File Manager in chapter 6.

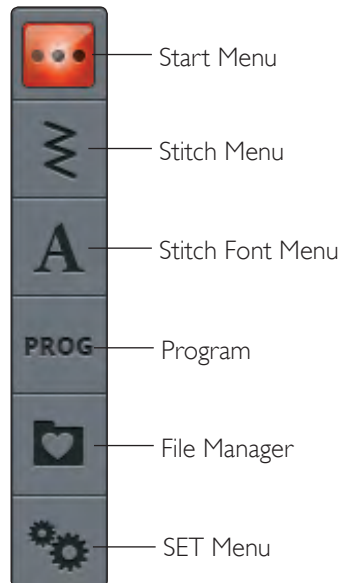

SET MENU

In the SET Menu you can make personal adjustments to the Machine Settings, Stitch Settings and Sewing Settings.

Touch the icons to activate a function or open a list of choices. When changing the Sewing Settings, the settings are saved after turning off the machine. If you make changes to Stitch Settings, the changes will not be saved after turning off the machine.

MACHINE SETTINGS

Information icon

The information icon opens a window which contains the machine's software version, memory usage and license information.

Language

Touch Language to view the languages. Select your desired language by touching it.

Audio Repeat

When active, the signal for some warning alerts or attention pop-up messages is repeated in intervals until it is cancelled.

Lock Screen

If there is the possibility of bumping into the screen and changing the stitch or settings while sewing, it is easy to lock the screen.

When activated, the screen is automatically locked everytime it is inactive for 10 seconds. A pop-up is shown on the screen and will remain locked until you touch OK on the pop-up.

Touch Screen Adjust

The screen might need to be calibrated to adjust to your touch.

Touch to open a view for calibrated the touch screen. Follow the instructions on the screen to calibrate the touch area.

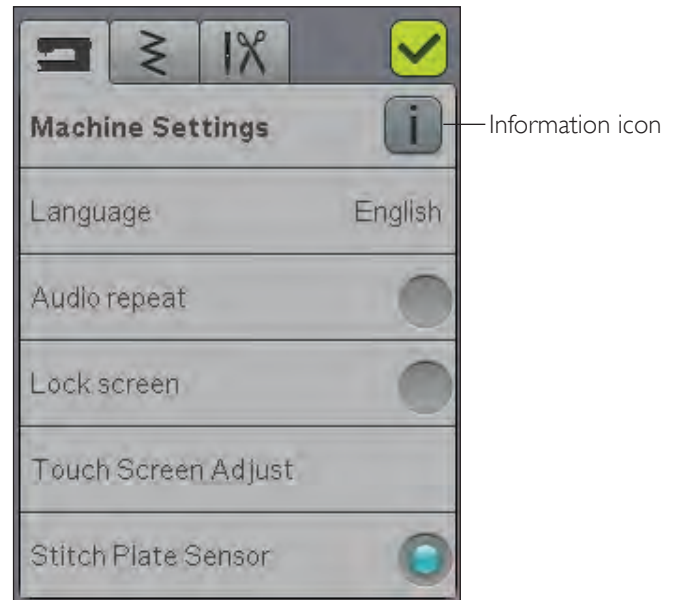
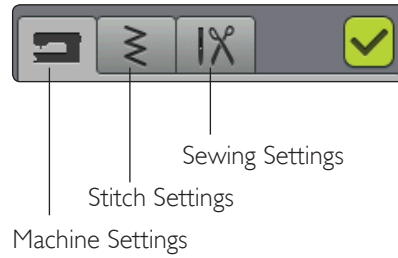

STITCH SETTINGS

In the Stitch Settings screen, you can set the presser foot pressure and balance a stitch or buttonhole. These settings will only be valid for the stitch that is currently selected.

If another stitch is selected or the same stitch is selected again, the stitch value is reset to the default value. The default number is shown in black, if the number has been changed it will be shown in red.

Balance

When sewing on special fabrics or doing a specialty technique, the balance of the stitch may need to be adjusted.

Length balance adjustment

Start by sewing a stitch on a piece of scrap fabric with stabilizer underneath. In the SET Menu, select Stitch Settings. If your stitch looks like (A), touch -, if your sewn sample looks like illustration (C) touch +. B is the perfectly balanced stitch in this example.

Width balance adjustment

Start by sewing a stitch on a piece of scrap fabric with stabilizer underneath. In the SET Menu, select Stitch Settings. If your stitch looks like (D), touch -, if your sewn sample looks like illustration (F) touch +. E is the perfectly balanced stitch in this example.

EXCLUSIVE SENSOR SYSTEM™ Feature -

Sensor Foot Pressure

With the Sensor Foot Pressure, the machine continuously senses the thickness of the fabric, automatically making necessary adjustments so that it feeds smoothly.

Touch + to increase or - to decrease the pressure of the presser foot on the fabric.

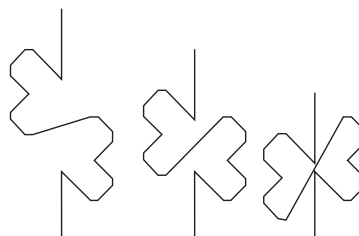

A

B

C

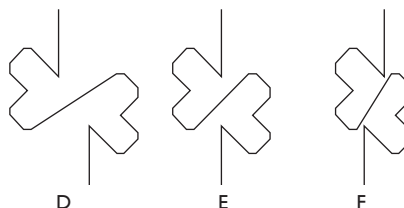

D

E

F

SEWING SETTINGS

Twin Needle

Touch the Twin Needle icon to open a list for twin needle width selections. When a twin needle size is selected, the width of all stitches is limited for the selected twin needle size to prevent needle breakage. The setting is kept until you turn the twin needle width to off.

Stitch Width Safety

Select the Stitch Width Safety function when using a straight stitch presser foot. The needle position is locked to center for all stitches to prevent damage to the needle, presser foot or needle plate.

When turning on the machine with this setting activated and for every stitch selection that is not a straight stitch, a pop-up message informs you that it is set to straight stitch. Deselect Stitch Width Safety to go back to normal sewing.

Note: Twin Needle and Stitch Width Safety cannot be used at the same time.

Selective Thread Cutter auto for sewing

To activate the function, select the Selective Thread Cutter auto for sewing in the Sewing Settings. The threads are cut automatically and the presser foot raises when you have completed a bartack etc. When deselected, no Selective Thread Cutter auto for sewing will be performed.

Sensor Presser Foot Lift

When selected, the Sensor Presser Foot Lift is activated. The presser foot will raise to pivot height when you stop sewing with the needle in the down position. When deselected, the presser foot will stay lowered even if the machine stops with the needle in down position or after a thread cut.

FIX Auto

When the FIX Auto is activated, the machine will begin a stitch with FIX stitches. To cancel the FIX Auto, uncheck the FIX Auto in the SET menu. If it is not activated use the FIX button on the front of your machine to fix your stitch.

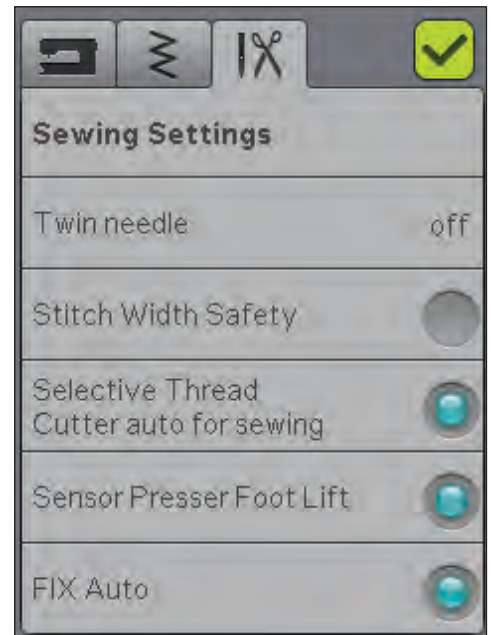

FREQUENTLY USED ICONS

OK

Confirms settings or changes and returns to previous window.



Cancel

Cancels settings and changes and returns to previous window.



Touch & Hold

Some icons have additional functions, marked with an triangle in the lower right corner. To access these functions, Touch & Hold the icon for a few seconds.





4 SEWING

In this chapter you will find information about how to select stitches, adjust, program and sew them.

TABS

On your screen there are two tabs: one Sewing Information where you can make changes to your stitch such as the length and width and see what is recommended for the stitch you have chosen. In the Stitch Menu you will find different categories of stitches and the stitches that are found in each one.

STITCH MENU TAB

The pink tab is called the Stitch Menu. When touching the tab a stitch selection menu will open. You can scroll through the different menus using the arrows below the screen.

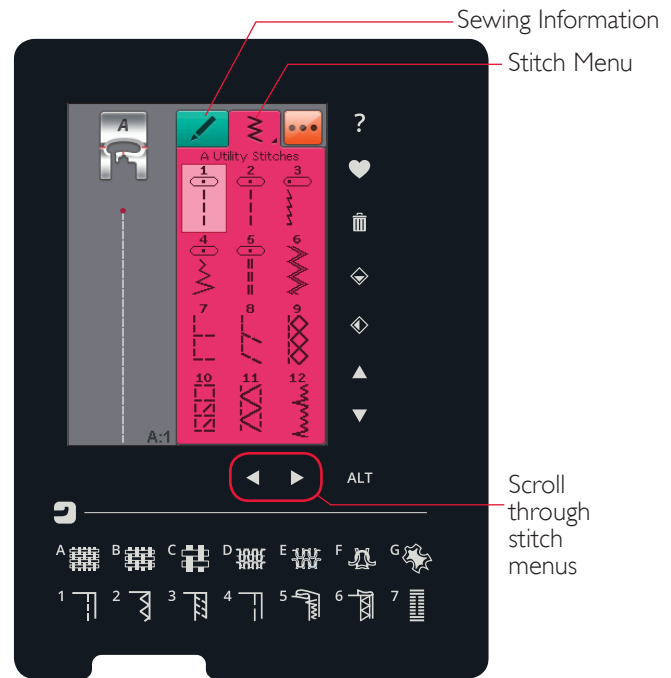

How to select a stitch

To select a stitch, touch the actual stitch in the stitch selection area. You can scroll through all the menus, using the arrows below the stitches. The name of the current menu is shown at the top of the stitch selection area.

The Stitch Menu tab has a triangle in the corner which means that you can Touch & Hold on the tab. Touch & Hold to show the menu foldout window. Touch the Stitch Menu of your choice and that stitch menu will open. The Stitch Menu icon has dots to indicate the number of pages within that menu. Touch the Stitch Menu icon again to go to the next page in the menu. The Stitch Menu foldout will stay open until you select a stitch, touch the tab or use the arrows.

Several Stitch Menus

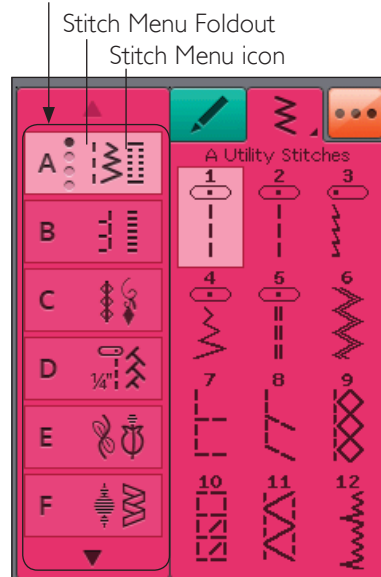

How to select a stitch font

On the toolbar, touch the Stitch Font Menu icon to open a list of stitch fonts. Touch the stitch font of your choice and the Program window will open. Write your text by touching the letters. The letters will be shown to the left in the screen. Touch OK and the stitch will load to Sewing Mode. Read more about how to program stitches in chapter 5.

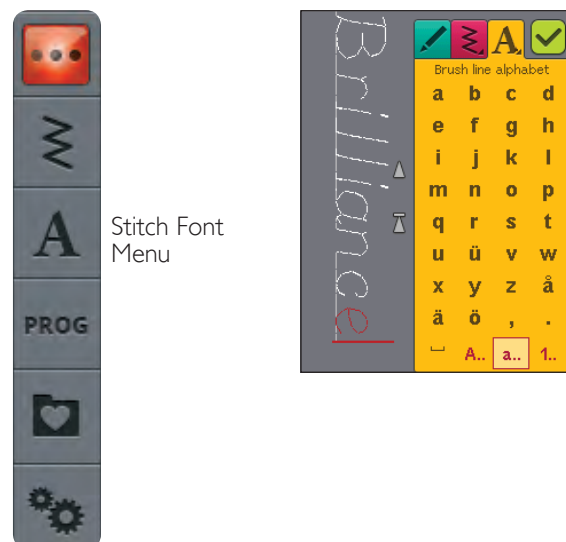

SEWING INFORMATION TAB

Your machine will choose the best stitch settings for the selected fabric. The Sewing Information tab consists of three parts.

At the top of the tab you will see the Exclusive SEWING ADVISOR™ choices that you have made; what fabric you have chosen and what technique you wish to use.

Below the Exclusive SEWING ADVISOR™ setting you will see what needle to use, if stabilizer and/or glide sole is needed.

In the lower part of your tab you will find the stitch adjustments. Here you can make changes to your stitch such as thread tension, set your machine to free-motion sewing, activate Stitch Re-Start, activate tapering, adjust stitch width, needle position, length, density, button sew-on and buttonhole length. The icons in this part of the window change depending on which stitch you have chosen. These changes only affect the selected stitch. Your changed settings will be reset to default when selecting another stitch. The changed settings are not automatically saved when turning your machine off. You can save the adjusted stitch in My Stitches (see page 4:5).

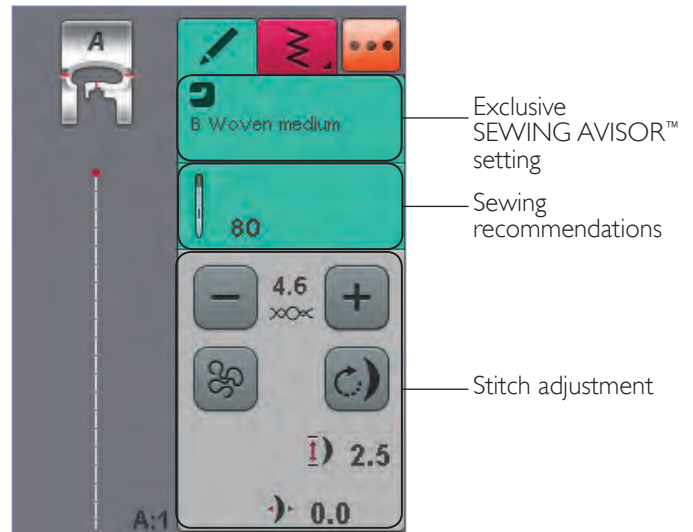

Thread Tension

Your machine automatically sets the best thread tension for the selected stitch. The thread tension can be adjusted for specialty thread, techniques or fabric. Touch + to increase and - to decrease the needle thread tension.

To understand the correct thread tension, sew a few sample straight stitches at different settings.

1. Begin with a tension that is too loose, i.e. set at the lowest number. The bobbin thread will lie straight and the top thread will be drawn to the underside of the fabric.
2. If you set the tension at the highest number, the bobbin thread will be visible on the top side of the fabric. The seam may pucker and the top thread might break.
3. The correct thread tension is set when the threads interlock in between both fabric layers or, in the case of decorative stitches, on the underside.

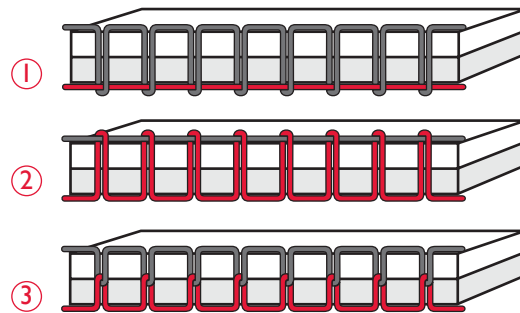
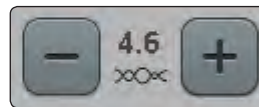

Free Motion Technique

When touching the Free Motion Technique icon a pop-up will appear allowing you to choose between two options: Free Motion Floating and Free Motion Spring Action.

Free Motion Floating

Activate to set the machine in Free Motion Floating mode. You can use presser foot R or an optional foot. The feed teeth will lower automatically.

When sewing free motion at low speed the presser foot will raise and lower with each stitch to hold the fabric on the needle plate while the stitch is being formed. At higher speed, the presser foot floats over the fabric while sewing. The fabric must be moved manually.

To adjust the presser foot height in Free Motion Floating mode, touch the + and - icon to make adjustments.

Skipped stitches can occur if your fabric moves up and down with the needle as you are stitching. Lowering the presser foot height will reduce the space between the presser foot and the fabric and eliminate the skipped stitches.

Note: Be careful not to reduce the presser foot height too much. The fabric must still move freely under the presser foot.

Note: If Free Motion Floating is activated, do not use any Spring action feet, as this might damage the presser foot. Activate Stitch Width Safety if the presser foot requires that.

Free Motion Spring Action

Select Free Motion Spring Action to activate the Free motion spring action mode. The feed teeth will lower automatically. A spring action foot will raise and lower with each stitch to hold the fabric on the needle plate while the stitch is being formed. The fabric must be moved manually.

If you are using the optional Sensor Q-foot activate Free Motion Spring Action and Stitch Width Safety.

Stitch Re-Start

When you stop sewing in the middle of a stitch, touch Stitch Re-Start to begin sewing at the beginning of the stitch. Any stitch adjustments made, will be kept.

Tapering

When touching the tapering icon a popup appears allowing you to choose how your stitch should start and finish. Tapering is only available when choosing a stitch in the Q-menu. Read more about tapering on page 4:17.

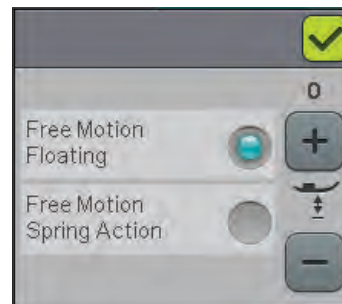
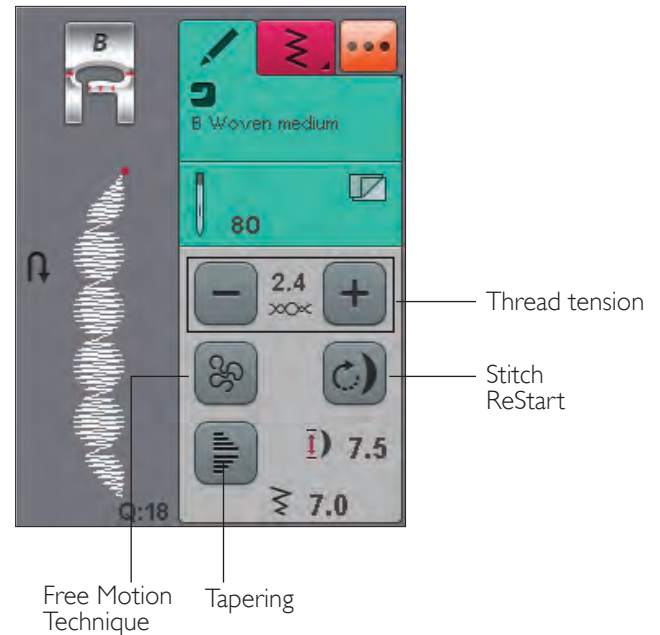

STITCH ALTERING

Your machine will set the best settings for each selected stitch. You can make your own adjustments on the selected stitch. The setting changes will only affect the selected stitch. The setting changes will be reset to default when selecting another stitch. The changed settings are not automatically saved when turning your machine off. You can save an adjusted stitch in a My Stitches to keep the adjustments.

ALT and function arrows

The ALT icon is used to change the functions connected to the arrows. When you touch ALT, one or both icons next to the arrows will change. Touch ALT again to change back to the original icons. Below you will find a description of the different icons that can appear when selecting a stitch.

Stitch Width

Decrease or increase the stitch width using the arrows below the stitch width icon. Default settings are shown in black numbers, adjusted settings in red.

Stitch Length

Increase or decrease the Stitch Length using the arrows next to the Stitch Length icon. If lengthening a Zig Zag stitch or a decorative stitch, the entire stitch will be longer. If lengthening a satin stitch where the density can be adjusted, the entire stitch will be longer but the density will remain the same.

Note: When trying to exceed minimum or maximum settings for width and length, a warning sound will be heard. The default setting is shown in black. Changed settings are shown in red.

Stitch Positioning

Use the arrows below to move the stitch to the right or to the left when using a straight stitch. The machine has a maximum of 29 needle positions (for a straight stitch).

When ALT function is selected on a stitch that has width position, the stitch can be moved right or left. The stitch position can only be changed to the limit of the maximum stitch width. Changing the stitch position will also limit the stitch width adjustment.

Stitch Density

Use the arrows beside the stitch density icon to adjust the density (the distance between the individual satin stitches that make up the entire stitch). The density does not affect the actual length of the complete stitch.

Touch the arrows to increase or decrease the value.

Note: Adjust the density when sewing with thicker thread or sewing with specialty threads and when a less or more dense satin stitch is desired.

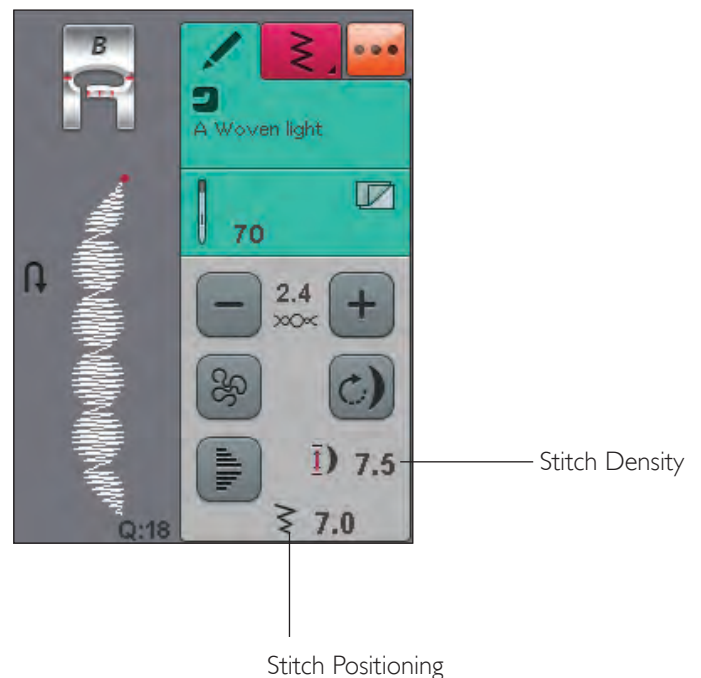
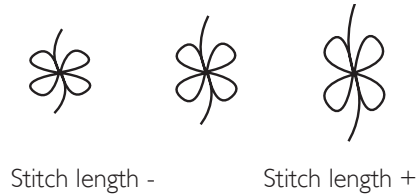
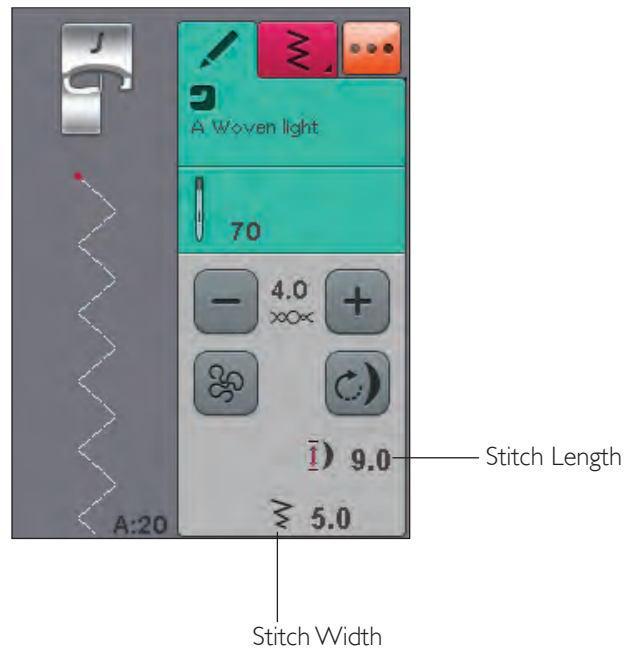

Buttonhole size

When sewing a buttonhole with the Sensor One-Step Buttonhole foot, you can set the button size. Measure your button and set the button size on screen.

Note: There is a guide in front of your machine where you can measure the size of the button.

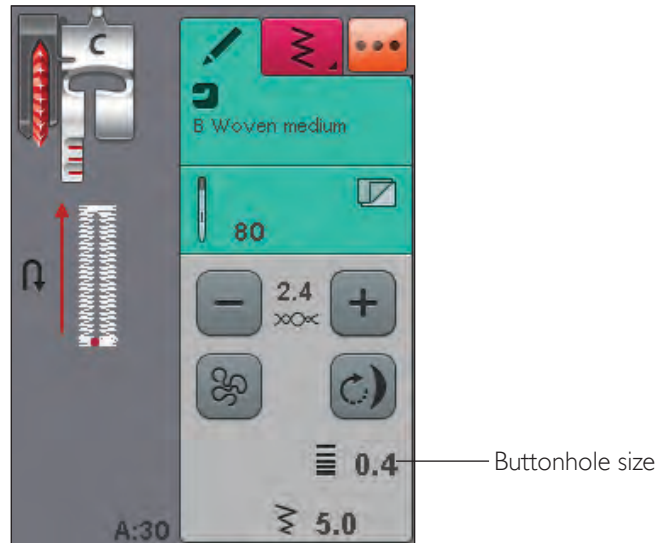

Button Sew On

When sewing a button, you can set the number of stitch repeats. Touch arrows to increase or decrease the number of stitch repeats. Read more about Button Sew On on page 4:15.

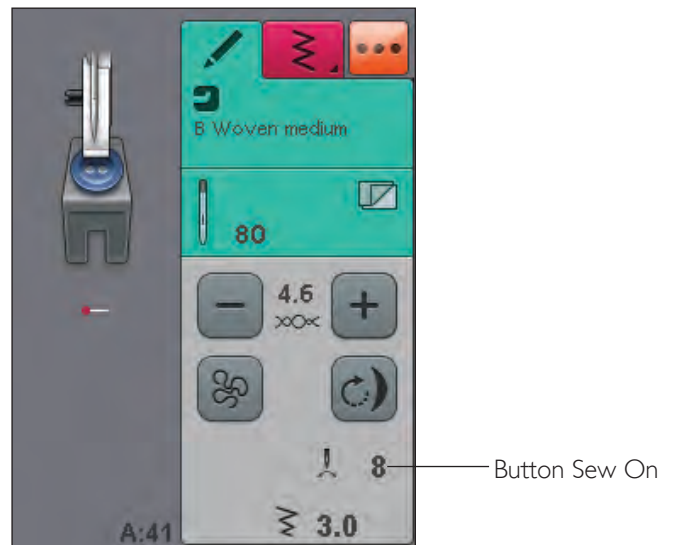

EXCLUSIVE SEWING ADVISOR™ FEATURE

Your new sewing machine has the HUSQVARNA VIKING® Exclusive SEWING ADVISOR™ feature. It is always active in and is located at the bottom of the Touch Screen. When beginning a sewing project, touch your fabric type and weight, then touch the technique you desire.

The Exclusive SEWING ADVISOR™ feature sets the best stitch, stitch length, stitch width, sewing speed, thread tension and sensor foot pressure for your project. The stitch is displayed on screen with presser foot and needle recommendations. When selecting sewing technique, the Sewing Information Tab is automatically opened.

FABRIC SELECTION

Woven or Knit

The difference between woven and knit fabric is the way the threads are put together. Woven fabrics are made of two thread systems, warp lengthwise and weft crosswise, that intersect at right angles. A knit fabric is made of one thread system with interlaced stitches. A knit fabric usually has stretch.

As a general rule, enter Woven for stable fabrics that have no stretch and Stretch for fabrics that have stretch.

Suggested Fabrics

A WOVEN LIGHT: chiffon, organza, batiste, silk, wool challis, etc.

B WOVEN MEDIUM: calico, quilting fabrics, wool crepe, broadcloth, etc.

C WOVEN HEAVY: denim, wool suiting and coating, canvas, terrycloth, etc.

D STRETCH LIGHT: charmeuse, nylon, tricot, single knit jerseys, etc.

E STRETCH MEDIUM: double knit, velour, swimwear, etc.

F STRETCH HEAVY: sweater knits, fleece, etc.

G LEATHER AND VINYL: suede, leather, vinyl and synthetic leather. When selected, the Non-Stick Glide Foot H is recommended for utility sewing. For decorative stitches and buttonholes, the Exclusive SEWING ADVISOR™ feature recommends the use of self-adhesive glide soles.

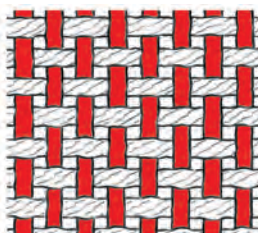
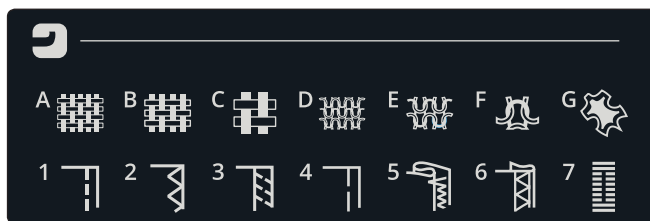

Woven fabric

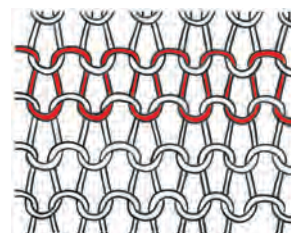

Knit fabric

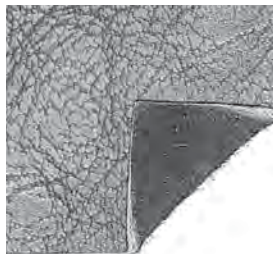

Leather



Vinyl

SEWING TECHNIQUES

1 SEAM: sews two pieces of fabric together.

2 OVERCAST: overcast fabric edges to prevent them from fraying and to help them lay flat.

3 SEAM/OVERCAST: sews the seam and overcasts the edge all at one time.

4 BASTE: a temporary stitching for fitting garments, gathering and marking.

5 BLIND HEM: creates an invisible hem on garments. Is not recommended for light weight fabric or for leather/vinyl. Your machine selects the best stitch possible for the fabric you select.

6 HEM: selects the best visible or top stitch hem for your fabric type and weight.

7 BUTTONHOLE: the Exclusive SEWING ADVISOR™ feature selects the best buttonhole possible for your fabric.

Note: If an unsuitable combination is selected (for example woven light-blind hem), your machine beeps, and the sewing techniques will remain unselected. However, the stitch can still be sewn, but it is not recommended by your machine.



SEWING TECHNIQUES

SEAM

A seam sews two pieces of fabric together with a seam allowance that will usually be pressed open. In most cases, edges of the seam allowance are finished with an overcast stitch before sewing the seam.

Seams in stretch fabric must stretch with the fabric. The stretch stitch makes a stretchy seam that is suitable for sewing together pieces of light stretch fabric.

FABRIC: Woven medium, cut in two.

SELECT: Woven medium fabric and Seam technique. (The Exclusive SEWING ADVISOR™ feature selects a straight stitch.)

USE: Presser foot A and size 80 needle as recommended.

SEW:

- Place fabrics right sides together. Put the fabric in position under the presser foot. Line up the edge with the 5/8" (15 mm) seam guide.
- Step on the foot control. The presser foot lowers automatically.
- Sew a seam. When finished, touch the Selective Thread Cutter. The Selective Thread Cutter cuts top and bobbin threads and the presser foot raises so you can remove your project.

FABRIC: Stretch light, cut in two.

SELECT: Stretch light fabric and Seam technique. (The Exclusive SEWING ADVISOR™ feature selects a stretch stitch.)

USE: Presser foot A and size 75 stretch needle as recommended.

SEW:

- Place fabric pieces right sides together. Put the fabric in position under the presser foot. Line up the edge with the 3/8" (10 mm) seam guide for a 5/8" seam.
- Step on the foot control. The presser foot lowers automatically.
- Sew a seam. When finished, touch the Selective Thread Cutter. The Selective Thread Cutter cuts top and bobbin threads and the presser foot raises so you can remove your project.

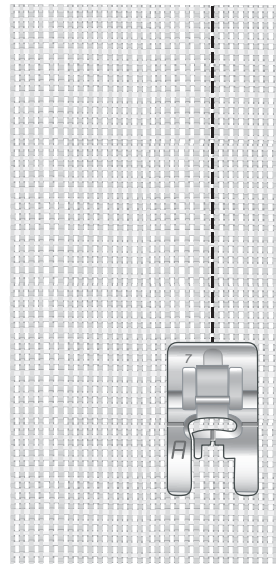

Straight stitch

Straight stitch can also be used for topstitching. For a more visible topstitch, lengthen the stitch and use heavier thread with a larger size needle.

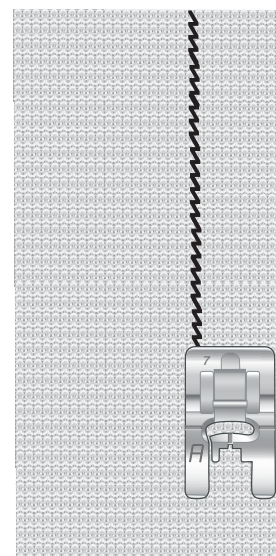

Stretch stitch

OVERCAST

Overcast fabric edges to prevent fraying and to help them lay flat. It is easiest to overcast before the garment is sewn together. Presser foot J is recommended for light and medium weight fabric to prevent puckering along the edge. Presser foot B is used for heavy weight fabric. Your Exclusive SEWING ADVISOR™ feature will select the best stitch length and stitch width for the fabric weight and recommend the presser foot and needle.

FABRIC: Woven medium.

SELECT: Woven medium fabric and Overcast technique. (The Exclusive SEWING ADVISOR™ feature selects a three-step Zig Zag stitch.)

USE: Presser foot J and size 80 needle as recommended.

Place the edge of a single thickness of fabric under presser foot J with the wire guide along the edge of the fabric. The three-step Zig Zag stitch sews over the wire guide to keep the edge of the fabric flat.

SEW:

- Step on the foot control. The presser foot lowers automatically.
- Sew to overcast the edge of the fabric.
- Touch the Selective Thread Cutter.

Note: It is not necessary to overcast leather or vinyl because they do not fray. However, the Exclusive SEWING ADVISOR™ feature allows you to, if desired. Select Leather/Vinyl fabric and Overcast technique on your Exclusive SEWING ADVISOR™ feature. (The Exclusive SEWING ADVISOR™ feature selects a Zig Zag stitch).

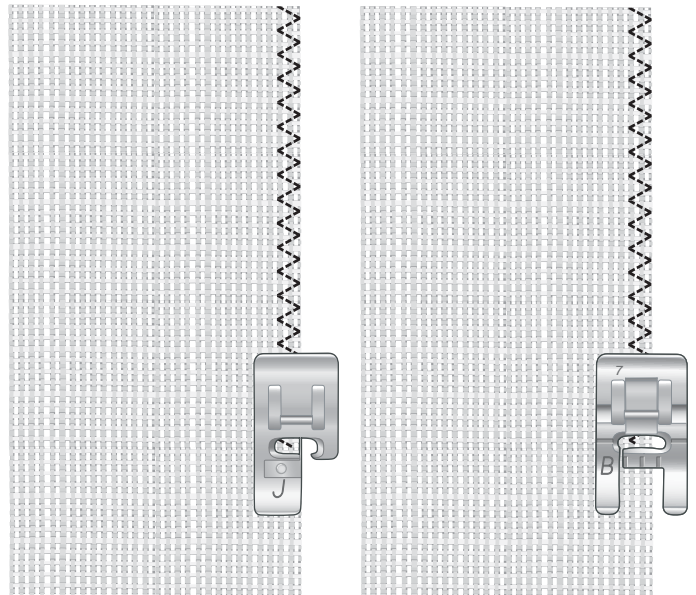
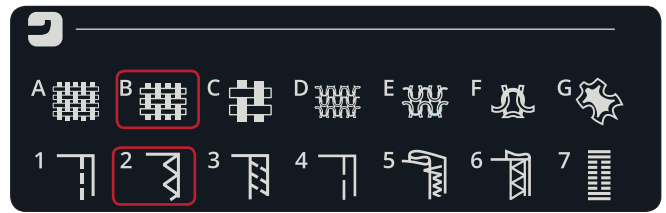

SEAM AND OVERCAST

The Seam/Overcast stitch sews the seam and overcasts the edges all at one time. There are a number of different Seam/Overcast stitches on your machine. Your Exclusive SEWING ADVISOR™ feature will select the best one for your fabric and make all adjustments automatically.

FABRIC: Stretch light, cut in two.

SELECT: Stretch light and Seam/Overcast on the Exclusive SEWING ADVISOR™ feature.

USE: Presser foot J and size 75 stretch needle as recommended.

SEW:

- Place fabric pieces right sides together. Put the fabric in position under the presser foot with the wire guide on the foot along the edge of the fabric.
- Step on the foot control. The presser foot lowers automatically.
- Seam/Overcast along one edge.
- Touch the Selective Thread Cutter.

Repeat the Seam/Overcast technique on stretch heavy fabric and on woven heavy fabric. Your Exclusive SEWING ADVISOR™ feature will select the best stitch, stitch length, stitch width, tension, presser foot pressure and sewing speed for each fabric type. Follow other recommendations given on the Interactive Color Touch Screen.

SEAM/OVERCAST FOR RIBBING

The Seam/Overcast technique is perfect for stitching ribbed neckbands and cuffs.

FABRIC: Sweatshirt fabric and ribbing strip.

SELECT: Stretch medium and Seam/Overcast.

USE: Presser foot B and size 90 stretch needle as recommended.

THREAD: Regular sewing thread.

Cut a mock neckline in the stretch fabric. Fold the ribbing double. Put the sweatshirt material and the ribbing right sides together. Sew the ribbing to the fabric with a 1/4" (6 mm) seam allowance. Stretch the ribbing while sewing.

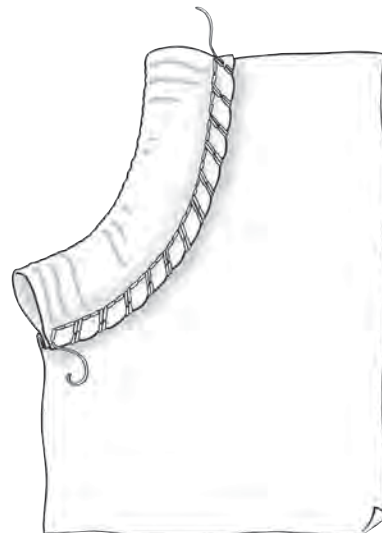
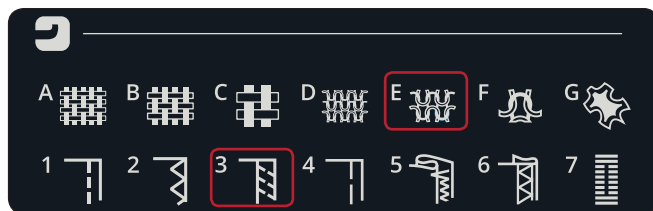
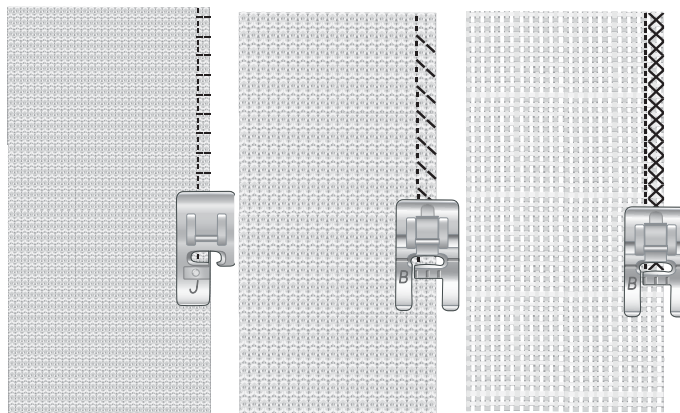
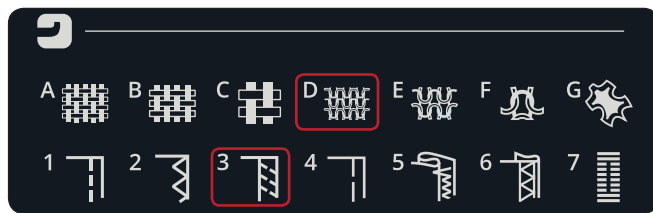

BASTE

Basting is temporary stitching for fitting garments, gathering and marking.

The SEWING ADVISOR™ feature automatically sets a long stitch length and reduces the tension so the threads are easy to remove or to pull for gathering.

FABRIC: Woven medium, cut in two.

SELECT: Woven medium fabric and Baste.

USE: Presser foot A and size 80 needle as recommended.

Place the fabrics right sides together. Put the fabric in position under the presser foot.

SEAM ALLOWANCE: 5/8" (15 mm).

SEW:

- Step on the foot control. The presser foot lowers automatically.
- Stitch along seam line.
- Touch Selective Thread Cutter.
- Pull bobbin thread to remove stitching.

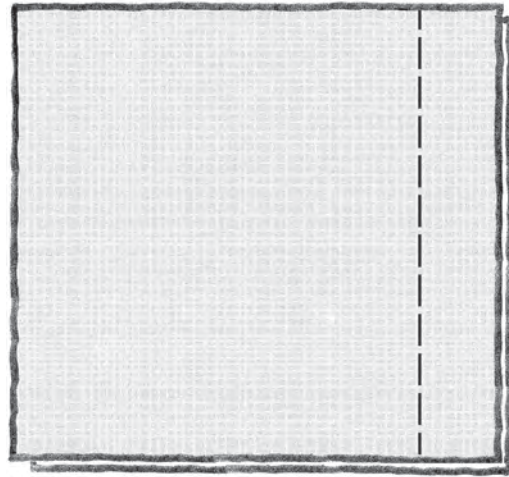
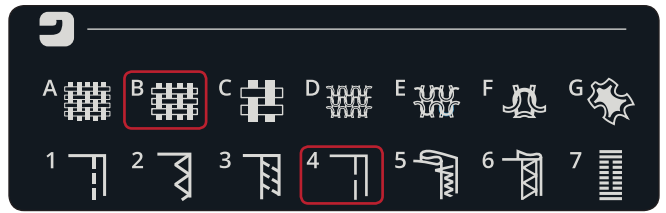

BLIND HEM

The blind hem creates an invisible hem on garments. There are two types of blind hem; one is recommended for medium to heavy woven fabrics, the other for stretch.

The blind hem is not suggested for light weight fabric, but your Exclusive SEWING ADVISOR™ feature will select the best stitch possible.

FABRIC: Wool or other medium-weight materials.

SELECT: Woven medium and Blind Hem.

USE: Presser foot D and size 80 needle as recommended.

THREAD: Regular sewing thread.

Fold the fabric as illustrated. Make sure the folded edge of the fabric follows the inside of the right “toe” of presser foot D.

Step on the foot control. The presser foot lowers automatically.

The left swing of the needle should just catch the edge of the folded fabric. If necessary, adjust the stitch width as needed to barely “catch” the fold by touching + or – on the width adjustment icon on your Interactive Color Touch Screen. After finishing your seam, touch the Selective Thread Cutter.

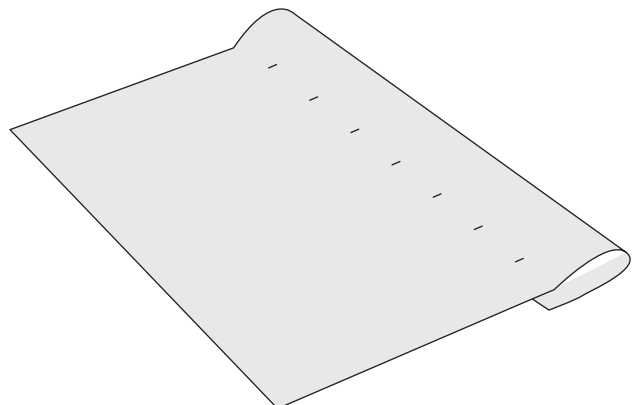
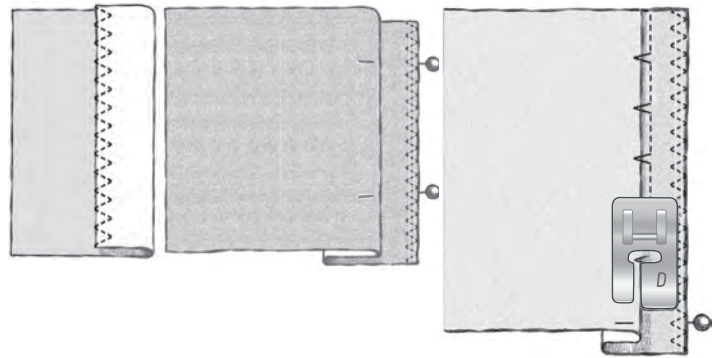
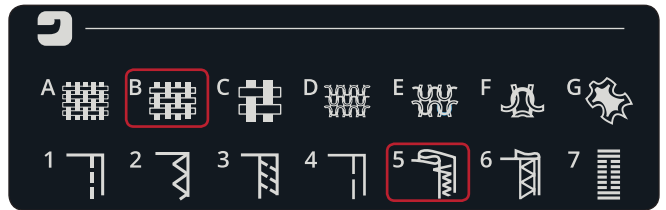

HEM

The Hem technique on your Exclusive SEWING ADVISOR™ feature will select the visible or topstitch hem that is best for your fabric weight and type. For woven fabric and leather and vinyl, a straight stitch is selected. For stretch fabrics, stitches that stretch are selected.

Jeans Hem

When sewing over seams in extra heavy fabric or a blue jeans hem, the foot can tip as it rides over the seam. The needle can hit the tipped foot and break. Use the multipurpose tool to balance the height of the hem as you sew.

FABRIC: Denim fabric.

SELECT: Woven heavy and Hem.

USE: Presser foot B as recommended and size 90 jeans needle.

Touch needle up/down to select the needle down position. Begin sewing the bottom hem at or near the center back. As you near the side seam, stop sewing. Your machine stops with the needle in the fabric and raises the presser foot. Insert the multipurpose tool from behind.

Both sides of the multipurpose tool are raised. Use the side which corresponds closest to the thickness of the seam. Step on the foot control to lower the presser foot and continue sewing slowly over the thick seam.

Stop sewing again just in front of the seam (notice how the needle is in the fabric). Remove the multipurpose tool and re-insert it under the presser foot from the front.

Sew a few stitches until the whole presser foot has passed the seam and is resting on the multipurpose tool. Stop sewing once again. The needle is in the fabric, and the presser foot lifts. Remove the multipurpose tool. Continue sewing the hem.

Stretch Hem

Select Stretch Medium and the Exclusive SEWING ADVISOR™ feature selects a flatlock stitch. Follow other recommendations given on the Interactive Color Touch Screen.

Fold a hem to the wrong side and stitch with flatlock stitch from the right side. Trim away excess fabric. Use this technique for belt loops too.

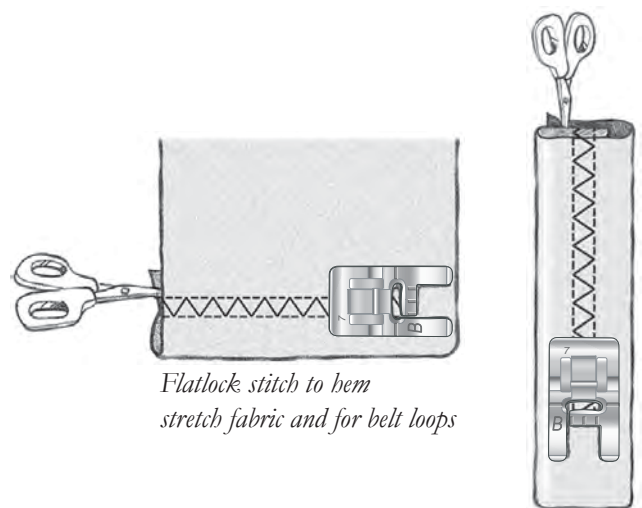
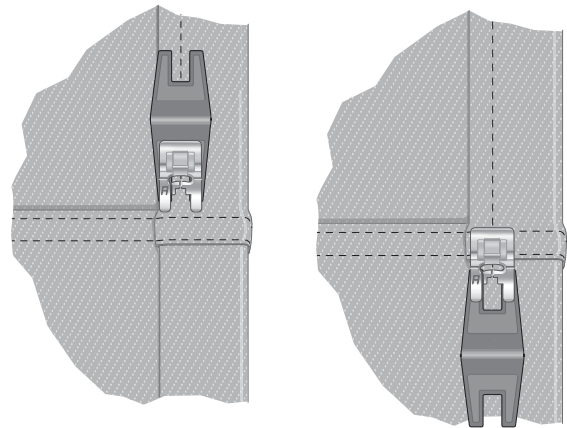

Flatlock stitch to hem stretch fabric and for belt loops

PERFECTLY BALANCED SENSOR ONE-STEP BUTTONHOLE

The Exclusive SEWING ADVISOR™ feature will select the best buttonhole and stitch settings for your fabric. Fabric should be interfaced and/or stabilized where buttonholes are to be sewn.

You can also select your buttonhole directly from the Buttonhole Menu B.

FABRIC: Woven medium and stabilizer.

SELECT: Woven medium fabric and Buttonhole.

USE: Size 80 needle as recommended.

1. Snap on the Sensor One-Step Buttonhole Foot.
2. Plug the cord into the socket (A) to the left above the needle area.
3. Place your button on the buttonhole ruler on the baseplate.
4. Set the size of the button in mm on your screen.

Before sewing, line up the white area on the side of the wheel with the white marking line on the foot.

When sewing, your machine automatically sews the buttonhole long enough to fit the selected button size.

The buttonhole size needed will vary with the thickness and style of your button. Always stitch a sample buttonhole on scrap fabric first.

Note: For woven heavy and leather, the Exclusive SEWING ADVISOR™ feature selects buttonholes that should not be sewn with the Sensor One-Step Buttonhole Foot.

Sew the Buttonhole:

- Fold fabric in two and place stabilizer inbetween. Mark the buttonhole placement on your fabric with your PICTOGRAM™ Pen. Set the length of the button size.
- Place fabric under Sensor One-Step Buttonhole Foot. The measurement wheel can be raised by lifting it, which makes it easier to place the fabric under the presser foot.

Note: Use the markings on the left toe of the Sensor One-Step Buttonhole Foot to position the garment edge. Place the edge of the garment at the middle mark to have 5/8" (15 mm) from the edge to the buttonhole.

- Step on the foot control. The Sensor One-Step Buttonhole Foot lowers automatically. A straight stitch is sewn away from you stabilizing the left buttonhole column, then the satin column is sewn toward you. This is repeated for the right column. The bartacks are automatic (see illustration 1). Keep the foot control depressed until the Selective Thread Cutter cuts the threads and the Sensor One-Step Buttonhole Foot is raised.

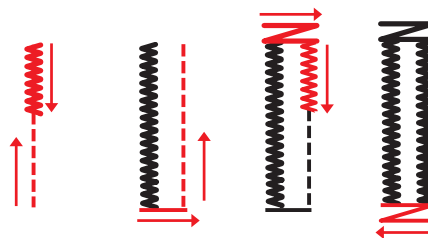
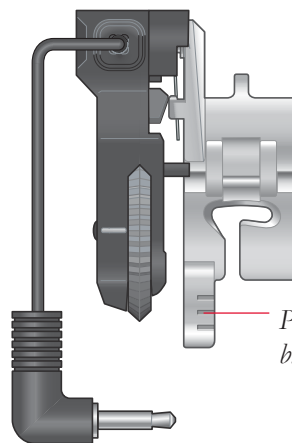
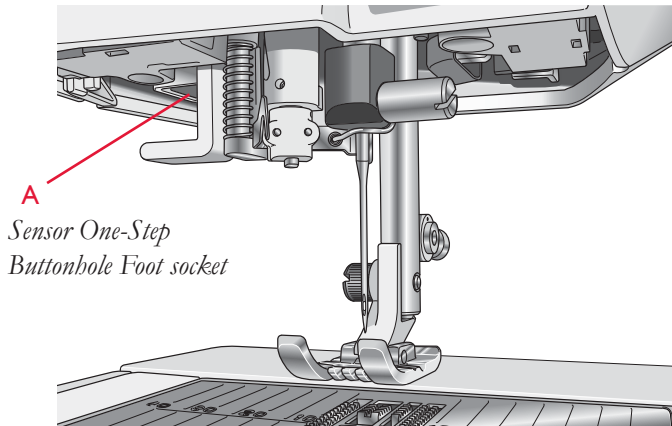
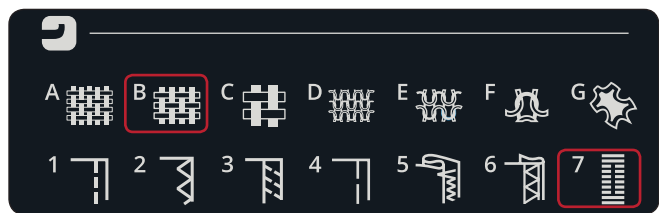

1. Sewing direction for satin stitch buttonholes sewn with the Sensor One-Step Buttonhole Foot

When sewing buttonholes without satin stitches or when using presser foot C, the sewing steps are different (there is no straight stitch step). See illustration 2.

Note: If you are sewing buttonholes in a very narrow area, snap on the standard foot C and sew your buttonhole according to the instructions below.

MANUAL BUTTONHOLE

To sew a manual buttonhole, use buttonhole foot C.

- Sew the first column as long as you want the buttonhole to be.
- Touch the reverse button. The machine sews the bartack and the second column.
- When the columns are aligned, press the reverse button to sew the second bartack. Keep the presser foot down until the machine stops.

Corded Buttonhole (Stretch fabrics)

When sewing buttonholes in stretch fabrics we recommend cording the buttonhole to increase the stability and to keep the buttonhole from stretching out.

1. Loop a piece of heavy thread or gimp cord over the finger on the back of Presser Foot C.
2. Stitch a buttonhole. Let the satin buttonhole columns stitch over the cord.
3. Stop sewing before the last end of the buttonhole is sewn. Lift the cord off the finger and pull out the slack.
4. Cross the cord in front of the needle and stitch the end of the buttonhole over the cord.

MANUAL BARTACK

Decide the length of your bartack manually with stitch A22.

SEW:

Place fabric under the presser foot. Touch Sensor Foot Down and Pivot twice and adjust the fabric if necessary. Step on the foot control, the Sensor Foot lowers automatically and stitch.

- Your machine will sew a straight stitch until you touch Reverse.
- Your machine will then sew in reverse until you touch reverse again.
- Your machine will then sew a Zig Zag, covering the straight stitches.
- Touch reverse to automatically tie off and cut the threads.

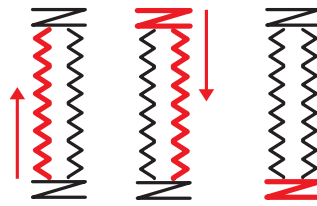

2. Sewing direction for buttonholes without satin stitches or satin stitch buttonholes sewn with presser foot C

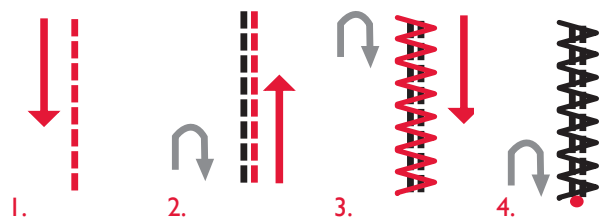

SPECIAL SEWING TECHNIQUES

The stitch menu P- Specialty Stitches, includes special sewing technique stitches like candlewicking, join and fold, twin gimping, quilting, appliqué, three hole yarn and edge stitches. These techniques may require some special presser feet and accessories. This is indicated by the optional presser foot icon.

Note: Use the Quick Help to find detailed information for each stitch.



Appliqué stitches

Use: fabric, stabilizer and fabric for appliqué cut in small pieces (1.5" x 1.5", 3.5cm x 3.5cm). Choose a fabric that doesn't fray too much.

1. Choose stitch L:8. Snap on the recommended presser foot.
2. Place your fabric under the presser foot and activate Needle Stop up/down to select the needle down position.
3. Step on the foot control and begin to stitch while you gently guide the fabric. The machine will start to sew and then stop automatically and the presser foot will raise to pivot position.
4. Insert a small piece of appliqué fabric under the presser foot, directly behind the needle.
5. Continue sewing until the machine automatically stops again.
6. Repeat step 3-5 until the desired stitch length is reached.
7. Trim all excess appliqué fabric.

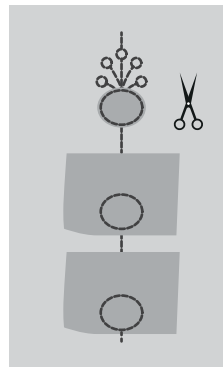
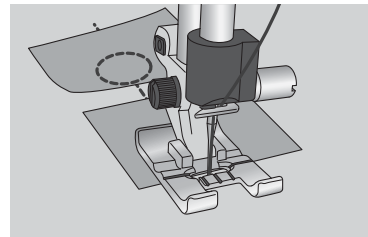

Tip: You can make your stitches more secure by adding a piece of paper backed fusible web cut in the same size as your appliqué fabric (the paper part should of course be removed first). After your stitch is stitched you cut away the excess together with the excess appliqué fabric. After everything is cut away, you can press your fabric in place.

DECORATIVE TAPERING STITCHES

Menu Q includes decorative stitches that can be tapered. Touch the Tapering icon to open a pop-up where you can select the tapering angle for your stitch. Touch the tab on the left to set what angle the beginning of your stitch should have, and touch the right tab to set the angle of the end of your stitch. Once you are finished, touch the OK icon to close the pop-up.

The machine will sew the tapered point that you have set and then continue with the selected stitch. When it has sewn the desired length, touch the reverse button. The stitch will taper to the end. Press the STOP button to repeat sewing the same tapered stitch automatically.

Tapering off

Choose Taper "off" if you do not want Tapering at the beginning or end of the stitch. If you select Taper "off" on both the beginning and end then the stitch will be a regular stitch without tapering.

FREE MOTION QUILTING

Free Motion Floating

When sewing free motion at a low speed, the foot will raise and lower with each stitch to hold the fabric on the stitch plate while the stitch is being formed. When sewing at a high speed, the foot floats over the fabric while sewing. The feed teeth must be lowered and the fabric is moved manually.

Most free motion sewing is stitched with a straight stitch or zig zag stitch. However, all stitches can be sewn in free motion mode. The direction and speed with which you move the fabric will determine how the stitch will look.

Note: Free Motion Spring Action – If you are using the optional Free Motion Spring Action presser foot, set the machine in Free Motion Spring Action mode. The feed teeth will be lowered. The setting remains when the machine is turned off. A pop-up message reminds you of the setting when you turn on the machine. Close the pop-up message by pressing OK. For normal sewing, turn off the Free Motion Spring Action mode in the Sewing Information tab.

The Free Motion Spring Action presser foot follows the up-and-down movement of the needle with the help of the spring and the arm on the presser foot. The feed teeth must be lowered and the fabric is moved manually.

Tip: Use the optional Open Toe Free Motion Spring foot.

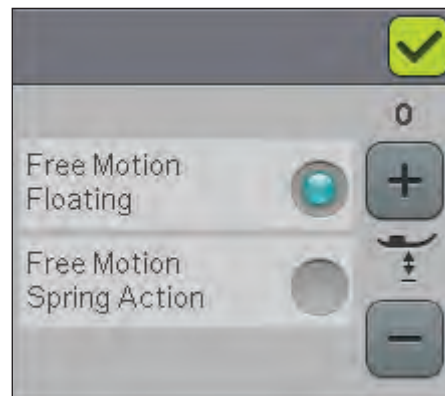
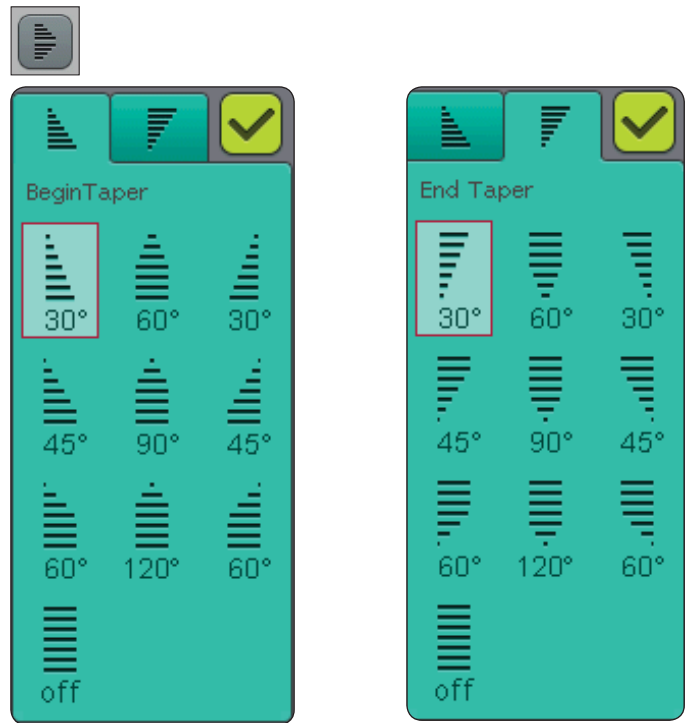

FREE MOTION STIPLING

You will have to move the fabric manually.

1. Touch needle stop up/down to select the needle down position.
2. Sew at a constant medium speed, moving the fabric randomly. Try drawing squiggles with the needle as you sew. Free motion stippling is usually a random wavy stitching that should be fairly close together but not crossing. The stitching should look like puzzle pieces.

Tip: Use the optional Open Toe Stippling Foot for better visibility when free motion stippling.

Note: To set the machine to regular sewing touch the Free motion icon and deselect the Free Motion setting.

1:1 Free Motion Stippling

Fabric: Woven medium with batting underneath.

Select: Woven medium on The Exclusive SEWING ADVISOR®, Straight Stitch 1, FreeM Floating in the Sewing Information tab.

Use: Presser Foot R and size 80 needle as recommended.





5 PROGRAM

This section of the Users Guide will help you make beautiful combinations of stitches and letters to decorate your fabric.

PROGRAM

You can combine stitches and/or letters and numbers to create programs. Combine various decorative stitches and stitch fonts from the machine or from an external device.

- Enter the Program window by touching the PROG icon on the Start Menu.
- Touch the Stitch or Font Menu to open the stitch or a font you wish to use. You can also Touch & Hold to open Stitch menus and Font menus.
- The active position is marked by a cursor and the selected stitch or letter will be marked in red. Inserted stitches will be placed at the cursor. Only the selected stitch can be adjusted. Move the cursor through the stitch program using the arrows on the screen.
- When changing a stitch in Program mode, it is only the marked stitch that is changed. If you enter Sewing Mode, you can make adjustments on the entire stitch combination.
- To close the Program window and sew your programmed stitch, touch the OK icon or just press the foot control or Start/Stop button.

Note: If you mix tapering stitches with other stitches in PROG, the programmed stitch cannot be tapered. However, if you only program tapering stitches, the entire programmed stitch can be tapered.

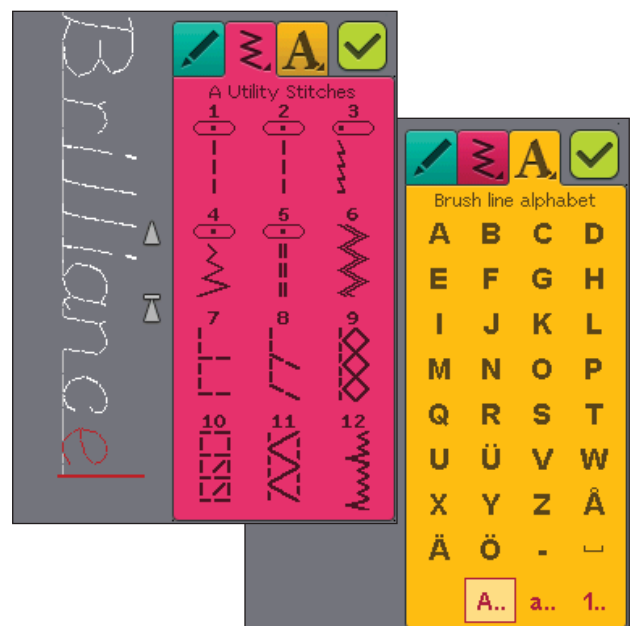
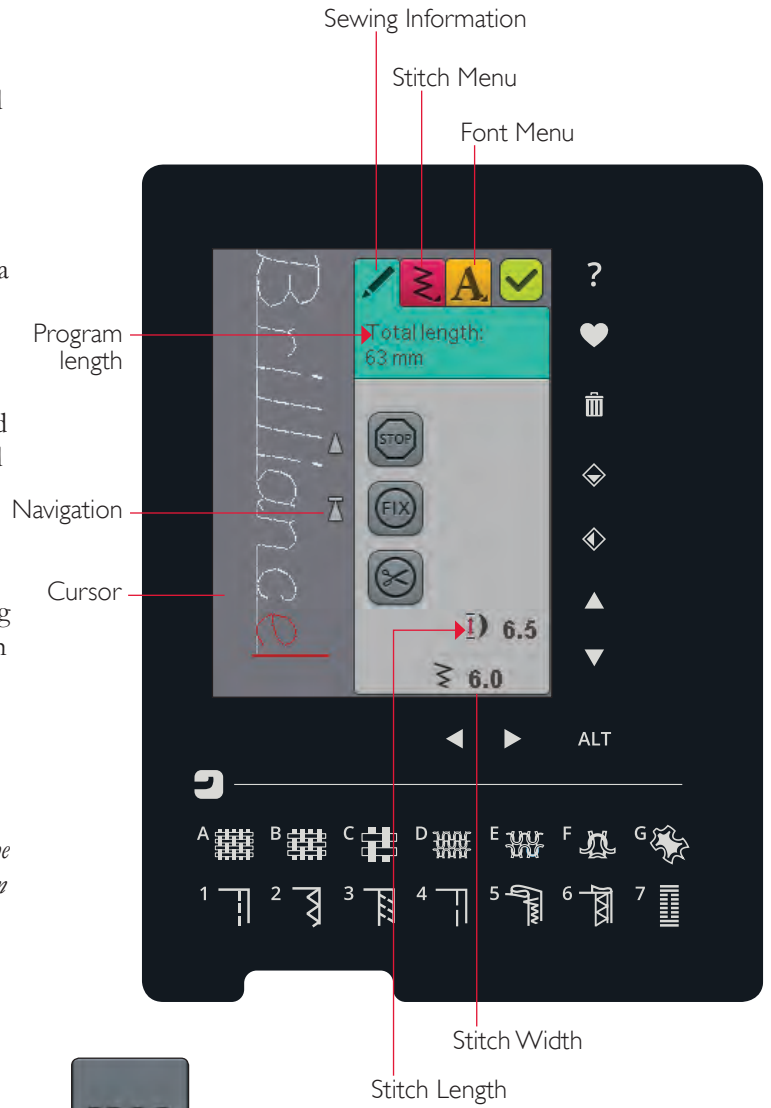

EDIT YOUR STITCH OR LETTERING PROGRAM

TABS IN PROGRAM MODE

There are three different tabs in Program Mode. The first is the Sewing Information Tab where you can make changes to each individual stitch that you have programmed. The second tab is the Stitch Menu Tab where you will find all the stitches that you can program. The third tab is the Font Menu Tab where you can choose which font you want to use. You can Touch & Hold on the Stitch Menu and Font Menu to open more stitches and fonts.

Insert a Stitch or Letter

Move the cursor where you want to add a stitch or letter using the arrows. Select the desired stitch you want to insert. It will be placed at the cursor.

Adjust Text and Stitches

You can mirror, adjust length and width or change the density of the selected stitch, in the same way as when sewing. Only the selected stitch will be adjusted.

Delete a Stitch or Letter

If you want to delete a stitch, move the cursor to the stitch you want to delete (the selected stitch will be red) and touch Delete. Touch & Hold Delete to delete the entire program.

Note: A straight line at the point of the Scroll Up or Down icon indicates scroll to beginning or end.

STITCH PROGRAM COMMANDS

You can insert STOP, FIX and thread cut commands into the stitch program. These commands will be included in the stitch program and will always be performed when sewing it.

Move the cursor to the position where you want to add a command using the scroll up/down arrows. Touch the button or an icon on screen and it will be added into the programmed stitch. This confirms that the command is inserted and it also shows where the command will be performed in the stitch program.

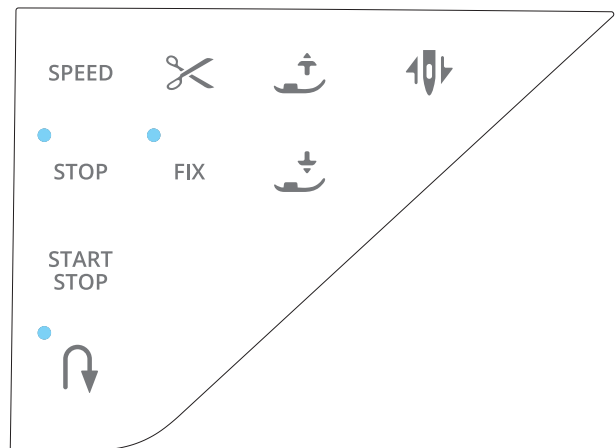
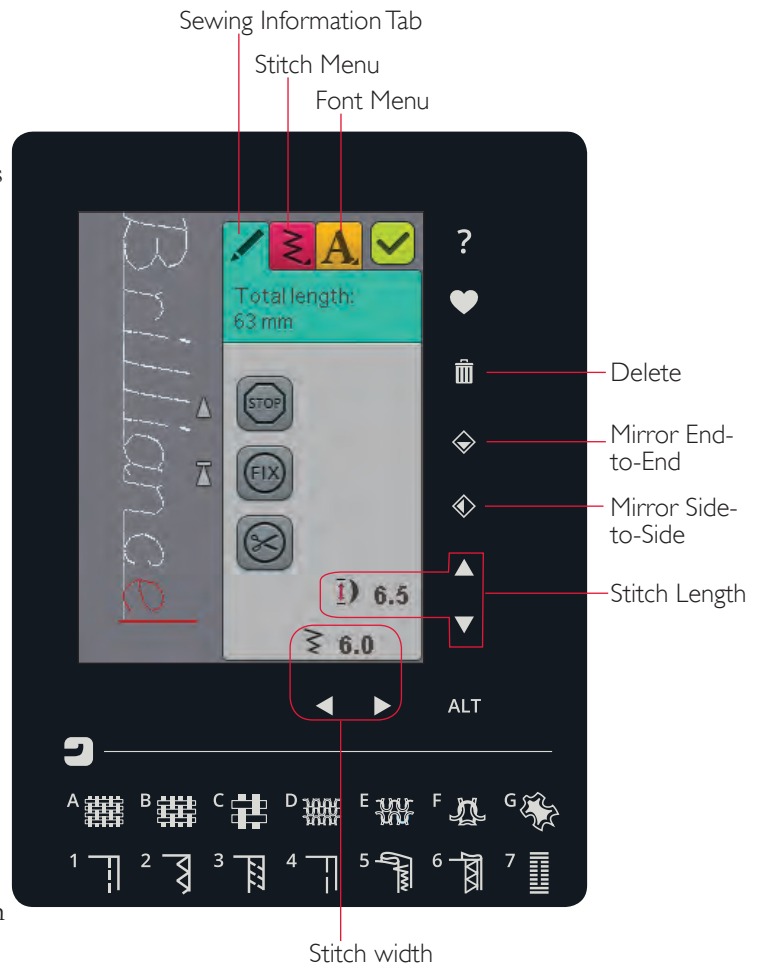

SEWING A STITCH PROGRAM

To sew the stitch program, load it by touching the OK icon at the top right corner in the program window. You can also press on the foot control and the stitch will load and you can start to sew.

Adjust the Entire Program

To adjust the entire program, close the program window. Adjustments made outside of Program mode will affect the whole program.

SAVE TO MY STITCHES

Once you are finished with your stitch, touch the OK icon at the top right hand corner to load the program. Touch the Save to My Stitches icon and the Save to My Stitches window will open. There are four menus, which you can scroll between, using the arrows at the bottom of the screen.

Previously saved stitches or stitch programs are shown in the My Stitches menu (U-menu). The new stitch or program can be saved at any free position. Simply touch a free position, and your stitch or stitch program is stored there.

Touch an occupied position and a pop-up message will ask you to confirm the overwriting of the old stitch. Touch OK to replace the old stitch with the new one. Touch Cancel to close the pop-up message, and choose another saving position.

Delete Saved Stitch or Program

To delete a saved stitch or program, touch Delete and then touch the stitch or stitch program. A pop-up message will ask you to confirm the deletion.

Note: If you Touch & Hold Delete, you can delete all your stitches on that menu. Once you have touched the delete icon, an image will be shown at the bottom of your screen. As long as that image is shown the Delete function is active, and you can delete stitches. Touch the Delete to deactivate the function.

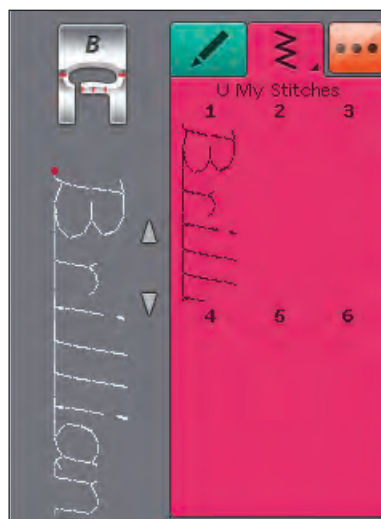
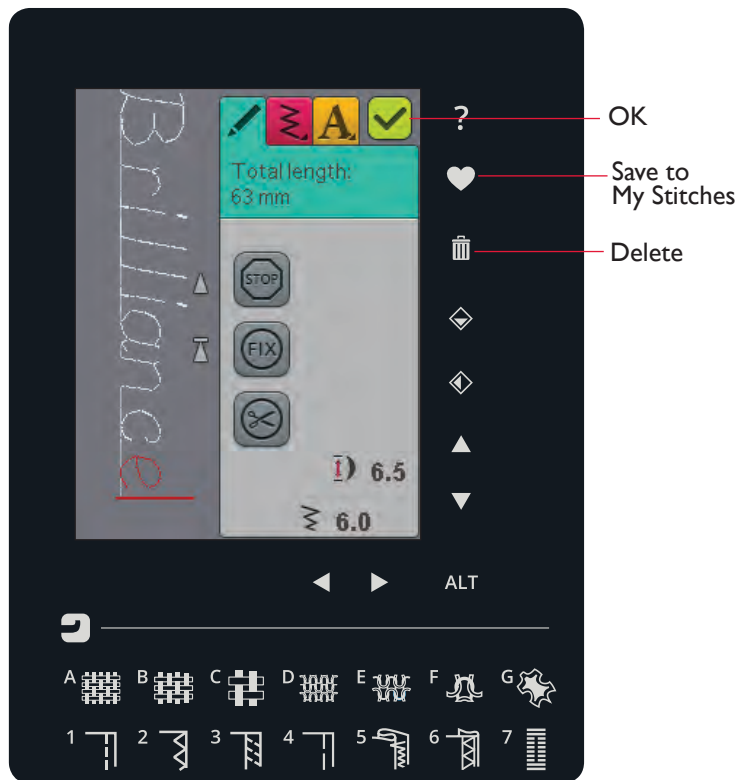

TO RE-LOAD A STITCH PROGRAM

Once you have finished making your program and touch OK, it will be loaded and is ready to be sewn. If selecting another stitch and then re-opening the Program mode, your stitch program will remain unchanged. Every time Program mode is closed, the stitch program will be loaded and ready to be sewn.

You can also load a previously saved program from the U-menu and make changes to the programmed stitch in Program mode.

Note: If the machine is turned off the program disappears from the Program Mode. Remember to save your program before turning the machine off.



6 FILE MANAGER

In this section we will take a closer look at how to organize your files in your sewing machine.

FILE MANAGER

The File Manager is used to open, organize, add, move, remove and copy your files. Use either built-in memory or an external device connected to your machine for storing files. To open the File Manager, touch the Start Menu icon and touch the File Manager icon.



AVAILABLE MEMORY

The built-in memory can store stitches and other files. To check how much memory is used in the built-in memory, touch the Start Menu icon, and SET menu, Machine Settings and touch the Information icon. A pop-up window shows how much memory is used.

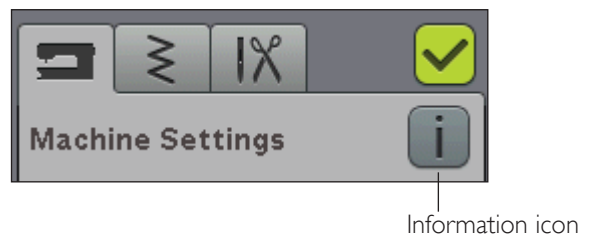

BROWSE FILE MANAGER

When File Manager is open you can reach your My Files folder and your USB stick (if you have one connected).

Touch any of these icons to display their contents in the selection area.

LIST/THUMBNAIL VIEW

Touch the List/Thumbnail view icon to show the files in the current folder listed in alphabetical order. For each file, file name and type will be displayed. Touch the List/Thumbnail view icon again to switch back to Thumbnail view.



MY FILES

In My Files you can create folders to keep your files organized.

USB

The USB icon is only active when a device is connected to the machine USB port.

OPEN A FOLDER

Touch & Hold on the folder to open it. The contents of the folder will be shown in the selection area.

MOVE UP ONE FOLDER LEVEL

Use the Move up one folder level icon to step up through the levels of folders. You can step up all the way to the first level. In the selection area you will see the files and folders for each level as you step through.

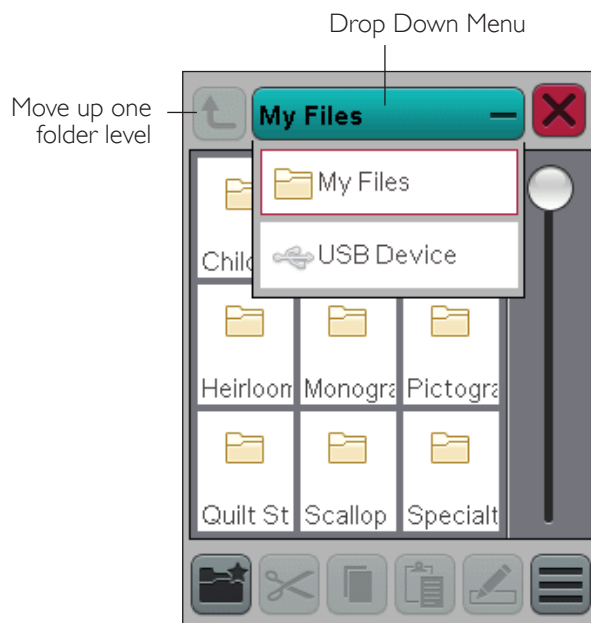

ORGANIZE

CREATE A NEW FOLDER

Touch the create new folder icon to create a new folder. A pop-up message opens where you can enter a name for your folder.

MOVE A FILE OR FOLDER

Use cut and paste to move a file or folder to another storage location.

Select the file or folder by touching it, then touch Cut. Open the folder where you want to place the file or folder. Touch Paste. The file or folder is now stored in the new location and is removed from the previous location.

COPY A FILE OR FOLDER

Use Copy and Paste to copy a file or folder to another place.

Select the file or folder, then touch Copy. Open the folder where you want to place the file or folder. Touch Paste.

RENAME A FILE OR FOLDER

To change the name of a folder, touch the folder then touch the Rename file or folder icon. A pop-up message opens where you can change the name.

DELETE A FILE OR FOLDER

To delete a file or folder, select it and touch Delete. A pop-up message asks you to confirm the deletion. If a folder is deleted, all files within the folder are deleted as well. To delete all files or folders in the currently open folder, Touch & Hold the Delete icon for a few seconds.

FILE MANAGER POP-UP MESSAGES

There is not enough available memory

Your machine can store files in the built-in memory. When the memory is full, you can move them to an external device by using the Cut and Paste functions.

When there is a small amount of memory left, your machine will alert you once. If you continue to fill the memory, it will not remind you again, until the memory is completely full.

System Busy

When the machine is loading, saving, moving files or performing a function that takes time, an hour glass is shown.

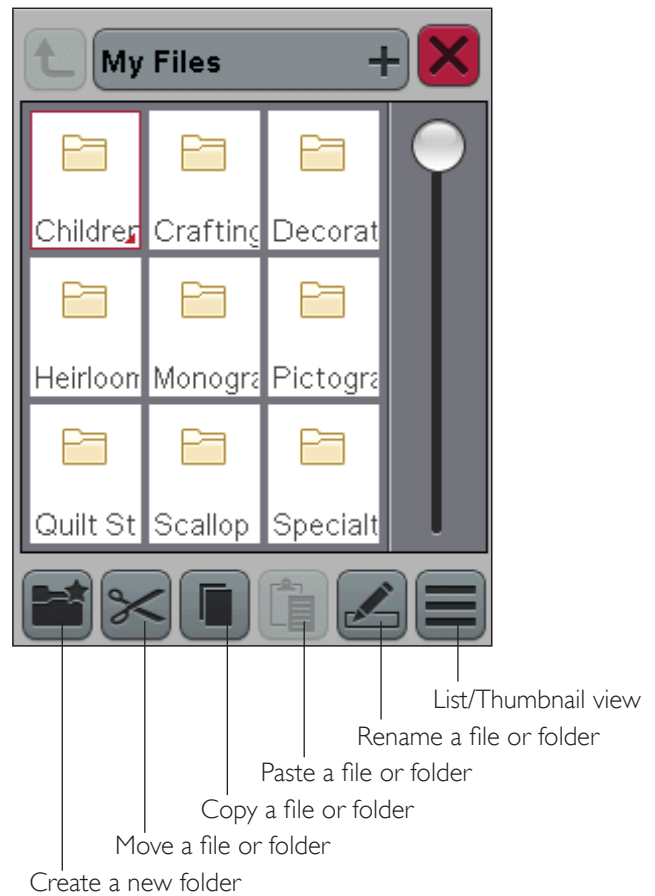



7

MAINTENANCE

In this section you will find information about how to take care of your machine and also a troubleshooting guide.

CLEANING THE MACHINE

To keep your sewing machine operating well, clean it often. No lubrication (oiling) is needed.

Wipe the exterior surface of your machine with a soft cloth to remove any dust or lint build up.

Cleaning the Bobbin Area

Remove the presser foot and slide off the bobbin cover. Lower the feed teeth. Place the screwdriver under the needle plate as shown in the picture and gently turn the screwdriver to pop off the needle plate. Clean the feed teeth with the brush found with the accessories.

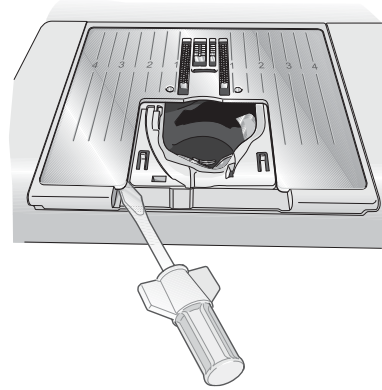

Cleaning under the Bobbin Area

Clean the area under the bobbin case after sewing several projects or any time you notice an accumulation of lint in the bobbin case area.

Remove the bobbin case holder (A) covering the front part of the bobbin case by lifting it up. Remove the bobbin case (B) by lifting it up. Clean with the brush.

 *Note: Use caution when cleaning around the Selective Thread Cutter knife (C).*

Put the bobbin case and the bobbin case holder back in place.

Note: Do not blow air into the bobbin case area. The dust and lint will be blown into your machine.

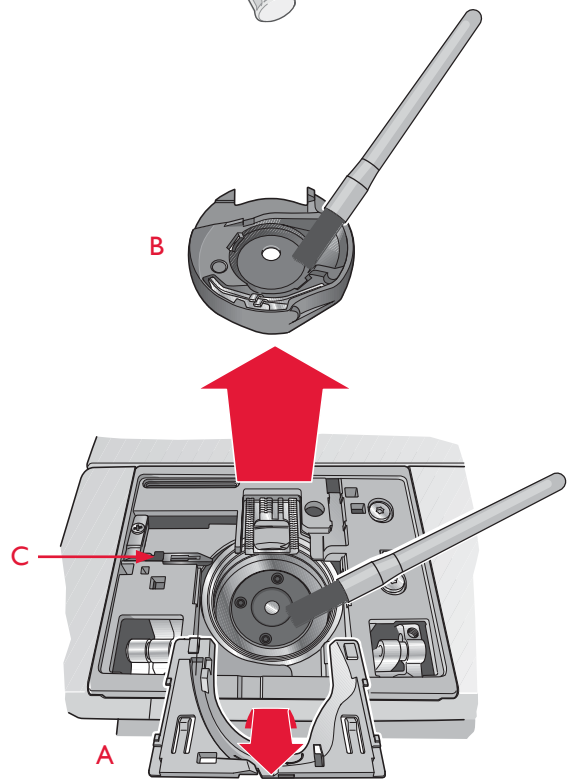

Replacing the Needle Plate

With feed teeth lowered, place the needle plate so that it fits into the notch at the back (D). Press the needle plate down until it clicks into place. Slide on bobbin cover.

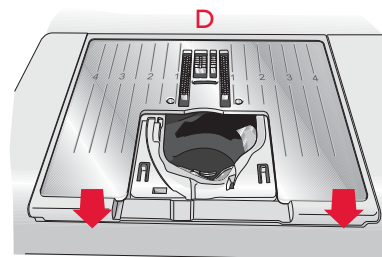

TROUBLESHOOTING

In this troubleshooting guide you will find solutions to the problems you may have with your machine. For further information please contact your local authorized HUSQVARNA VIKING® retailer who will be happy to help you.

Have Your Sewing Machine Serviced Regularly by your Local Authorized Dealer!

If you have followed this troubleshooting information and still have problems, take your sewing machine to your dealer. If there is a specific problem, it is a great help to test sew with your thread on a scrap of your sewing fabric and bring it to your dealer. A sewing sample will often give much better information than words.

General Problems

Bobbin alarm does not work?	Clean lint from bobbin area and use only the original HUSQVARNA VIKING® bobbins approved for this model.
<i>Thread cutter does not cut the thread?</i>	<i>Remove stitch plate and clean lint from bobbin area. Enable Selective Thread cutter Auto in the SET Menu.</i>
Fabric does not feed?	Make sure that the feed teeth are not lowered.
<i>Wrong stitch, irregular or narrow stitch?</i>	<i>Deactivate Twin Needle or Stitch Width Safety Sewing Settings in the SET Menu.</i>
The needle breaks?	Insert needle correctly as described in chapter 2.
<i>The machine will not sew?</i>	<i>Check that all plugs are securely plugged into the machine and into the wall socket.</i>
The screen displays the startup screen?	Touch the touch screen to activate. Turn off Screen Saver in the SET Menu.
<i>Icons on the touch screen are not activated when touched?</i>	<i>Calibrate the touch screen. Calibrate is found in the SET Menu (Touch Screen Adjust).</i>
The sewing machine screen and/or function buttons do not respond to touch?	The sockets and function buttons on the machine can be sensitive to static electricity. If the screen does not respond to touch, turn the machine OFF and then ON again. If the problem persists, contact your authorized HUSQVARNA VIKING® retailer.

Needle Thread Breaks

Did you insert the needle properly?	Insert needle correctly as described in chapter 2.
<i>Did you insert a wrong needle?</i>	<i>Use needle system 130/705 H.</i>
Is the needle bent or blunt?	Insert a new needle.
<i>Is the needle too small for the thread?</i>	<i>Change the needle to the proper size for the thread.</i>
Is the needle plate hole damaged?	Change the stitch plate.
<i>Did you thread the machine properly?</i>	<i>Check how the machine is threaded. Rethread the machine (see page 2:5).</i>
Are you using poor thread with slubs or thread which has become dry?	Change to a new high quality thread purchased from an authorized HUSQVARNA VIKING® retailer.
<i>Is a correct spool cap used?</i>	<i>Attach a spool cap of the right size for the actual thread spool (see chapter 2). If you are using a vertical spoolpin, you should not have a spoolcap on top of the spool.</i>
Is the best spool pin position used?	Try a different spool pin position (vertical or horizontal).

Bobbin Thread Breaks

Did you insert the bobbin properly?	Check the bobbin thread (see page 2:8).
<i>Is the needle plate hole damaged?</i>	<i>Change the stitch plate (see page 7:2).</i>
Is the bobbin area full of lint?	Clean lint from bobbin area and use only the original bobbins approved for this model (see page 7:2).

Is the bobbin wound correctly?

Wind a new bobbin.

Are you using the correct bobbin?

Use only the original bobbins for this model (see page 7:2)

The Machine Skips Stitches

Is the needle bent or blunt?

Insert a new needle.

Did you insert the needle properly?

Insert needle correctly as described in chapter 2.

Did you insert a wrong needle?

Use needle system 130/705 H.

Did you thread the machine properly?

Check how the machine is threaded.

Is the correct presser foot used?

Attach correct presser foot.

Is the needle too small for the thread?

Change the needle.

Is the fabric moving up and down with the needle when free-motion sewing?

Reduce the presser foot height by touching the Free Motion icon and reducing the presser foot height.

The Seam has uneven Stitches

Is the thread tension correct?

Check needle thread tension and the threading.

Are you using too thick or slubbed thread?

Change the thread.

Is the bobbin thread evenly wound?

Check bobbin winding (see page 2:7).

Is a correct needle used?

Insert a proper needle correctly as described in chapter 2.

The Machine does not Feed or Feeds Irregularly

Did you thread the machine properly?

Check how the machine is threaded and rethread the machine (see page 2:5).

Has sewing lint collected between the feed teeth?

Remove the needle plate and clean the feed teeth with a brush.

System report

Is your machine displaying the system report pop-up?

When the system report pop-up appears, go to My Files/Reports and locate the file (SystemReport01.dmp or higher number). Save the file to a USB stick. Send the file together with a short description of what you were doing before the pop-up appeared to product.improvement@husqvarnaviking.com. After sending the file, remove it from your machine.

Non-original Parts and Accessories

The warranty does not cover any defect or damage caused by use of non-original accessories or parts.

Index

A

Accessories.....	1:7
Accessory Box.....	1:7
Accessory box, Remove.....	2:3
Add file.....	6:2
Adjust Text and Stitches.....	5:3
Adjust the Entire Program.....	5:4
ALT.....	4:5
ALT and function arrows.....	3:4, 4:5
Audio Repeat.....	3:6
Auxiliary spool pin.....	1:6, 2:4, 2:6
Available Memory.....	6:2

B

Balance.....	3:7
Bartacks.....	4:16
Base plate.....	1:6
Baste.....	4:8, 4:12
Blind Hem.....	4:8, 4:12
Blindhem Foot D.....	1:8
Bobbin alarm.....	7:3
Bobbin case holder.....	7:2
Bobbin cover.....	1:6, 2:8
Bobbins.....	1:7
Bobbin spindle.....	2:7
Bobbin thread.....	3:2
Bobbin Thread Breaks.....	7:3
Bobbin Thread Low.....	4:18
Bobbin thread tension spring.....	2:8
Bobbin winder.....	1:6
Bobbin winder lever.....	1:6
Bobbin Winding	
Specialty Threads.....	2:7
Through the Needle.....	2:7
Bobbin winding thread guide.....	1:6
Browse File Manager.....	6:3
Brush.....	1:7
Built-In needle threader.....	1:6, 2:5
Built-In USB port.....	1:6
Buttonhole.....	4:8, 4:14
Manual.....	4:15
Buttonhole Foot C.....	1:6, 1:8
Buttonhole Foot, Sensor One-Step.....	1:9
Buttonhole size.....	4:6
Button reed.....	1:7
Button ruler.....	1:6
Button Sew On.....	4:6
Button Size.....	4:6

C

Cancel.....	3:8
Carrying case.....	1:7
Changing the Needle.....	2:9

Changing the needle plate.....	2:8
Changing the Presser Foot.....	2:8
Check Needle Thread.....	4:18
Cleaning the Bobbin Area.....	7:2
Cleaning the machine.....	7:2
Cleaning under the Bobbin Area.....	7:2
Clear Open Toe Foot.....	1:9
Color Touch Screen.....	3:5
Connecting the foot control cord.....	2:2
Connector for foot control.....	1:6
Connector for power cord.....	1:6
Connect to the power supply.....	2:2
Connect to USB port.....	2:3
Copy.....	6:3
Copy a File or Folder.....	6:4
Copy file.....	6:2
Corded Buttonhole.....	4:15
Create a New Folder.....	6:4
Cursor.....	5:2
Cut.....	6:3
Cut-Away Stabilizer.....	2:10

D

Darning Foot R.....	1:9
Decorative Stitches.....	1:14
Decorative Stitch Foot B.....	1:8
Decorative Tapering Stitches.....	4:16
Delete.....	3:4, 5:3
Delete a Stitch or Letter.....	5:3
Delete File or Folder.....	6:4
Delete Saved Stitch or Program.....	5:4
Denim Needle.....	2:9
Disintegrating Stabilizer.....	2:10
Disk is Full.....	6:4
Drop Down Menu.....	6:3

E

Edge/Quilting guide.....	1:7
Edit your Stitch or Lettering Program.....	5:3
Embroidery Foot R.....	1:9
Embroidery Needle.....	2:9
Embroidery thread.....	2:10
Exclusive SENSOR SYSTEM™.....	3:3, 3:7
Exclusive SEWING ADVISOR™.....	3:4, 4:7

F

Fabric Selection.....	4:7
FAT32.....	2:3
Feed teeth.....	2:8
Felt pad.....	1:7, 2:4, 2:6, 2:7
File Manager.....	3:5, 6:2
File Manager pop-up messages.....	6:4
FIX.....	3:2, 3:3, 5:3
FIX Auto.....	3:8
Foam.....	1:8

Folder Structure.....	6:4
Font Menu.....	5:2, 5:3
Foot control.....	1:7
Foot control cord.....	2:2
Free arm.....	1:6
Free motion.....	1:9
Free Motion Floating.....	4:4, 4:17
Free Motion Quilting.....	4:17
Free Motion Spring Action.....	4:4, 4:17
Free Motion Stippling.....	4:17
Free Motion Technique.....	4:4
Function button panel.....	1:6
Function Buttons.....	3:2, 3:3

G

Glide Plates.....	1:9
-------------------	-----

H

Handle.....	1:6
Handwheel.....	1:6
Hard cover.....	2:3
Heirloom Stitches.....	1:13
Hem.....	4:8, 4:13
Horizontal spool pin.....	2:4, 2:5, 2:7

I

Insert a Stitch or Letter.....	5:3
Inserting the Bobbin.....	2:8
Intellectual Property.....	7:11
Interactive Color Touch Screen.....	1:6
Iron-on Tear-Away.....	2:10

J

Jeans Hem.....	4:13
----------------	------

K

Knit.....	4:7
-----------	-----

L

Language.....	3:6
leather.....	1:8
Leather.....	4:7
LED-lights.....	1:6
Length balance adjustment.....	3:7
Lid.....	1:6
List View.....	6:3
Lock Screen.....	3:6

M

Machine needs to rest.....	4:18
Machine overview.....	1:6

Machine Settings.....	3:6
Magnifying glass.....	2:8
Main spool pin.....	1:6, 2:4, 2:7
Manual Buttonhole.....	4:15
Mirror End to End.....	5:3
Mirror end to end/mirror side to side.....	3:4
Mirror Side to Side.....	5:3
Move a File or Folder.....	6:4
Move file.....	6:2
Move Up One Folder Level.....	6:3
Multipurpose tool.....	1:7, 2:9, 4:13
My Files.....	6:3
My Stitches.....	4:3
My Stitches menu.....	5:4

N

Needle bar.....	1:6
Needle clamp.....	1:6
Needle plate.....	2:8
Needle positions.....	4:5
Needles.....	1:7, 2:9
Changing.....	2:9
Needle screw.....	2:9
Needle Stop Up/Down.....	3:2
Needle Thread Break.....	7:3
Needle Threader.....	1:6, 2:5
Needle thread guide.....	1:6
Non-original Parts and Accessories.....	7:4
Non-Stick Glide Foot H.....	1:8
Not a Programmable Stitch.....	5:5

O

OK.....	3:8
Omnimotion stitches.....	1:9, 1:15
ON/OFF.....	2:3
Open.....	6:2
Open a File.....	6:3
Open a Folder.....	6:3
Organize.....	6:2, 6:4
Overcast.....	1:8, 4:8, 4:10
Overview.....	
Machine.....	1:6
Overview Touch Area.....	3:4

P

Pack Away.....	2:3
Paste.....	6:3
Perfectly Balanced Sensor One-Step Buttonhole.....	4:14
PICTOGRAM™ Pen.....	2:10, 4:14
Plastic.....	1:8
Pop-up messages.....	
File Manager.....	6:4
Program.....	5:5

Sewing	4:18
Power cord	1:7
Connect	2:2
Presser feet and bobbin holder	1:7
Presser Foot	1:6, 1:8
Changing	2:8
Presser foot ankle	1:6
Presser foot bar	1:6
Presser Foot C	1:9
Pre-Tension Thread guide	1:6, 2:5, 2:7
Program	3:5, 5:2
Program in Sewing Mode	5:2
Program length	5:2
Program mode	3:5
Program pop-up messages	5:5

Q

Quick Help	3:4
Quilter's 1/4" Piecing foot P	1:9
Quilting guide	1:7
Quilt Stitches	1:13

R

Re-Load a Stitch Program	5:5
Remove file	6:2
Remove from USB port	2:3
Remove Sensor One-Step Buttonhole Foot	4:18
Rename a File or Folder	6:4
Rename file or folder	6:3
Replacing the Needle Plate	7:2
Reverse	3:3

S

Safety instructions	1:2
Satin Stitches	1:8, 1:12
Save	5:4
Save a Stitch Program	5:4
Save to My Stitches	5:4
Save to My Stitches/My Files	3:4
Screwdriver	1:7
Seam	4:8, 4:9
Seam and overcast	4:8, 4:11
Seam/Overcast	1:8
Seam/Overcast for Ribbing	4:11
Seam ripper	1:7
Select a stitch	4:2
Select a stitch font	4:2
Selective Thread Cutter	3:2
Selective Thread Cutter Auto for sewing	3:8
Selective Thread Cutter knife	7:2
Self-Adhesive Glide Plates	1:9
Sensor Foot Down and Pivot	3:3
Sensor Foot Pressure	3:7

Sensor Foot Up and Extra Lift	3:3
Sensor One-Step Buttonhole Foot	1:6, 1:9, 2:5, 4:6, 4:14
Sensor One-Step Buttonhole Foot socket	1:6
Sensor Presser Foot Lift	3:8
Sensor Q-foot	4:4
SET Menu	3:2, 3:3, 3:6, 7:3
SEWING ADVISOR™	4:7
Sewing a stitch program	5:4
Sewing Information	4:2
Sewing Information Tab	4:3, 5:3
Sewing pop-up messages	4:18
Sewing recommendations	4:3
Sewing Settings	3:6, 3:8
Sewing Techniques	4:8, 4:9, 4:16
Sewing Thread	2:10
Side-motion	1:9
Side Motion Foot S	1:9
Special Sewing Techniques	4:16
Specialty stitches	1:15
Specialty threads	2:4
Speed	3:2
Spool cap	1:7, 2:4, 2:5, 2:6, 2:7
Spool Pins	2:4
Stabilizers	2:10
Start Menu	3:5, 5:2
Start/Stop	3:3
Sticky Stabilizer	2:10
Stitch adjustment	4:3
Stitch altering	4:5
Stitch Density	4:5
Stitch Font menu	3:5
Stitch Font Menu	4:2
Stitch Length	4:5, 5:3
Stitch Menu	3:5, 4:2, 5:2, 5:3
Stitch Menu Tab	4:2
Stitch Overview	1:10
Stitch Plate	1:6, 7:3
Stitch Positioning	4:5
Stitch program commands	5:3
Stitch Program Out of Range	5:5
Stitch Re-Start	4:4
Stitch Settings	3:6, 3:7
Stitch width	5:3
Stitch Width	4:5
Stitch Width Safety	3:8
STOP	3:2, 3:3, 5:3
Straight stitch plate	1:7
Stretch heavy	4:7
Stretch Hem	4:13
Stretch light	4:7
Stretch medium	4:7
Stretch Needle	2:9
Stylus	1:7
Stylus holder	1:6
System Busy	6:4

T	
Tab.....	4:2
Tabs in Program mode.....	5:3
Take-up lever.....	2:5
Tape measure.....	1:6
Tapering.....	4:4
Tapering Stitches.....	1:16, 4:16
Taper Satin Stitch.....	4:16
Tear-Away Stabilizers.....	2:10
The Machine Skips Stitches.....	7:4
Thread cut command.....	5:3
Thread Cutter.....	1:6, 2:6, 7:2, 7:3
Thread cutter for bobbin winding.....	1:6
Threader hook.....	2:5
Thread guide.....	2:5, 2:7
Threading	
Needle.....	2:5
Twin Needle.....	2:6
Upper thread.....	2:5
Threading the needle	
Manually.....	2:5
Thread net.....	1:7
Threads.....	2:10
Thread Sensor.....	2:6
Thread slots.....	1:6
Thread take-up lever.....	1:6
Thread Tension.....	4:3
Thread tension disc for bobbin winding.....	1:6
Thread tension discs.....	1:6, 2:5, 2:6, 2:7
Thumbnail view.....	6:3
Toolbar.....	3:5
Top thread.....	3:2
Touch Area.....	3:4
Touch & Hold.....	3:8
Touch Screen Adjust.....	3:6
Transparent Thread.....	2:10
Triple needle.....	2:5
Troubleshooting.....	7:3
Twin Needle.....	2:5, 2:9, 3:8
Twin Needle Threading.....	2:6

U	
Universal Needle.....	2:9
Unpacking.....	2:2
Update your machine.....	2:11
USB.....	6:3
USB port.....	2:3
USB stick.....	2:3
Utility.....	1:12
Utility Foot A.....	1:8
Utility Stitches.....	1:10

V	
Vertical spool pin.....	2:4, 2:5, 2:6
Vintage Stitches.....	1:14

Vinyl.....	1:8
------------	-----

W	
Warranty card.....	1:7
Water Soluble Stabilizer.....	2:10
Width balance adjustment.....	3:7
Winding Bobbin.....	2:7
Winding Specialty Threads.....	2:7
Wing Needles.....	2:5, 2:9
Woven.....	4:7
Woven heavy.....	4:7
Woven light.....	4:7
Woven medium.....	4:7

Z	
Zipper Foot E.....	1:8

You have purchased a modern, updatable sewing machine. As we regularly release software updates, it is possible that there may be some differences between the machine software and the software described in the User's Guide. Consult your local Authorized HUSQVARNA VIKING® retailer, and be sure to visit our website at www.husqvarnaviking.com for the latest updates of the software, the User's Guide and the Quick Guide.

We reserve the right to change the machine equipment and the assortment of accessories without prior notice, or make modifications to the performance or design. Such modifications, however, will always be to the benefit of the user and the product.

Intellectual Property

Patents protecting this product are listed on a label positioned underneath the Sewing Machine.

VIKING, BRILLIANCE, PICTOGRAM, SEWING ADVISOR, KEEPING THE WORLD SEWING and EXCLUSIVE SENSOR SYSTEM are trademarks of Singer Sourcing Limited LLC.

HUSQVARNA and the “H” Crown Device are trademarks of Husqvarna AB.

© 2018 Singer Sourcing Limited LLC. All rights reserved.



Please note that on disposal, this product must be safely recycled in accordance with relevant National legislation relating to electrical/electronic products. Do not dispose of electrical appliances as unsorted municipal waste, use separate collection facilities. Contact your local government for information regarding the collection systems available. When replacing old appliances with new ones, the retailer may be legally obligated to take back your old appliance for disposal free of charge.

If electrical appliances are disposed of in landfills or dumps, hazardous substances can leak into the groundwater and get into the food chain, damaging your health and well-being.

Manufacturer:

VSM Group AB
Drottninggatan 2, SE-56184, Huskvarna, SWEDEN



KEEPING THE WORLD SEWING™