

# TL-6020

1.0 kN Top Mount

## Level Up.

The TL-6020 U-profile is the intelligent onward development of the TL-6010 profile. Here the outstanding feature consists in the increase of mounting distances, which now enables the use of the profile also on an anchor bolt without countersunk head. Therefore, mounting the product is not only faster and more cost efficient, but also statics have improved considerably.

It can be used in exterior applications, withstands a linear load of 1.0 kN and is appropriate for glass thicknesses between 12 mm and 21.52 mm.

## Essential Features

- | Slimline, elegant design and low-maintenance
- | ONLEVEL FLEXFIT Glass Adjustment Tool
- | Extension pin holes
- | Drainage holes
- | For use with Top Cover 3.0 kN
- | For glass thicknesses between 12 - 21.52 mm
- | For applications of 1.0 kN in private areas, the mounting distance amounts to 60 cm



**TESTED**  
according to  
**BS6180**

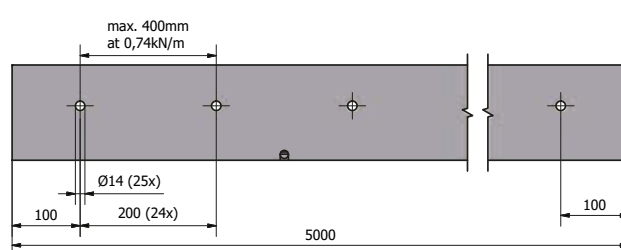
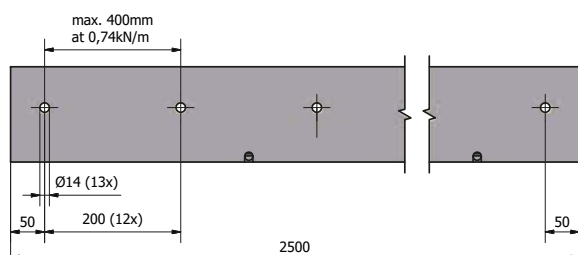
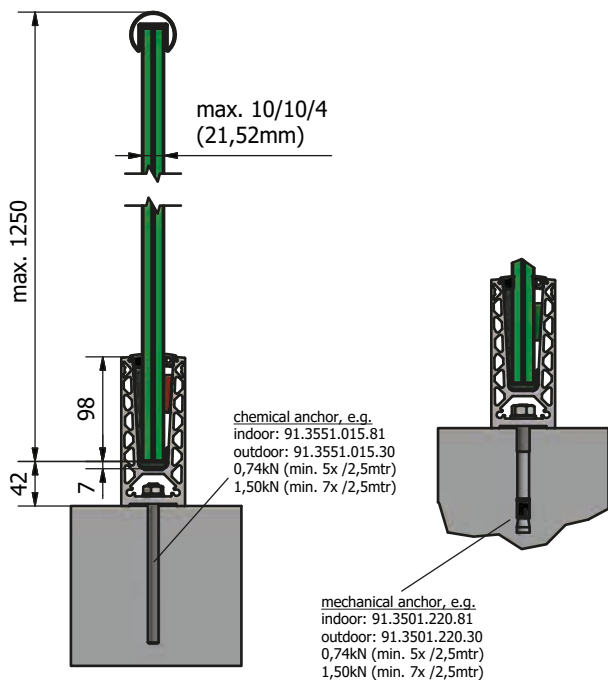



Increased stability with the same looks

Integrated multifunctional sophisticated chamber for enabling larger drilling distances



Top mount

# TL-6020 | 1.0 KN TOP MOUNT

## Glass profile



| Height: 140 mm  
| Width: 60 mm  
| Sales unit: 1 piece

Model 6020	Mill finish	Plain aluminium	RAL coloured
Length	Art. no.	Art. no.	Art. no.
2500	-	10.6020.002.11	-
5000	10.6020.005.10	10.6020.005.11	10.6020.005.13/16/18

## Inside corner / outside corner 90°



| Side length inside: 140 mm  
| Side length outside: 200 mm  
| Sales unit: 1 piece

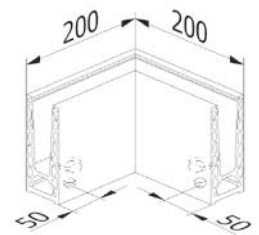

Model 6020	Mill finish	Plain aluminium	RAL coloured
	Art. no.	Art. no.	Art. no.
	10.6020.390.10	10.6020.390.11	10.6020.390.13/16/18

## End cap, left/right



| For use on the left and right  
| Sales unit: 1 piece

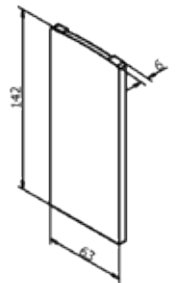

Model 6020	Mill finish	Plain aluminium	RAL coloured
Application	Art. no.	Art. no.	Art. no.
left/right	10.6020.490.10	10.6020.490.11	10.6020.490.13/16/18

## End cap for staircase, left/right



| For use on the left and right  
| cut-to-size  
| Sales unit: 1 piece

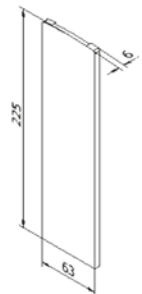

Model 6020	Mill finish	Plain aluminium	RAL coloured
Application	Art. no.	Art. no.	Art. no.
left/right	10.6020.491.10	10.6020.491.11	10.6020.491.13/16/18

# TL-6020 | 1.0 KN TOP MOUNT

## Spacer



You do not have any drainage options on your balcony?!  
So that you do not need to install a dam on your balcony, you can simply mount the spacers beneath your profile.

- | Inner drill hole:  $\varnothing$  14 mm
- | Sales unit: 13 pieces

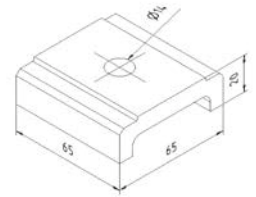

Model 6020	Mill finish	Plain aluminium	RAL coloured
	Art. no.	Art. no.	Art. no.
	10.6020.500.10	10.6020.500.11	10.6020.500.13/16/18

## Extension pin



- | Length: 40 mm
- | Diameter:  $\varnothing$  6 mm
- | Sales unit: 8 piece

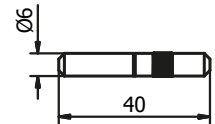

Model 7001	AISI 316 (inside & outside)
	Art. no.
	90.7001.640.31

## Fischer fixing anchor FIS AM M10x150



- | Finish interior application: zinc-plated steel (inside)
- | Finish exterior application: V4A (exterior)
- | Required number per 2500 mm: 13 pieces
- | Suitable mortar: 91.3000.010.00
- | Injection mortar (91.3000.010.00) is sufficient for  $\pm$  26 anchors
- | Sales unit: 10 pieces

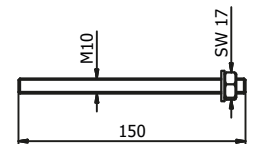

Model 3551	zinc-plated steel (inside)	AISI 316 (exterior)
	Art. no.	Art. no.
	91.3551.015.81	91.3551.015.30

## Fixing anchor steel



- | Finish interior application: zinc-plated steel (inside)
- | Finish exterior application: V4A (exterior)
- | Required number per 2500 mm: 13 pieces
- | M10 x 60 mm
- | Sales unit: 25 pieces

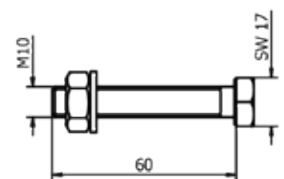

Model 6020	zinc-plated steel (inside)	AISI 316 (exterior)
	Art. no.	Art. no.
	91.6020.060.81	91.6020.060.30

# TL-6020 | 1.0 KN TOP MOUNT

## Fischer fixing anchor FAZ II 12/10



- | Finish interior application: zinc-plated steel (inside)
- | Finish exterior application: V4A (exterior)
- | Required number per 2500 mm: 7 pieces
- | Sales unit: 20 pieces

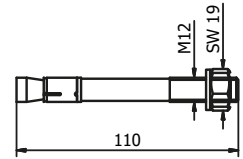

Model 3501	zinc-plated steel (inside)	AISI 316 (exterior)
	Art. no.	Art. no.
	91.3501.210.30	91.3501.210.81

## Screw anchor for concrete



- | Suitable for our profiles without countersinking
- | Finish interior application: Zinc-plated steel (interior) HUS3-H 10x90
- | Finish exterior application: V4A (outside) HUS3-HR 10x95
- | Tangential screwdriver required

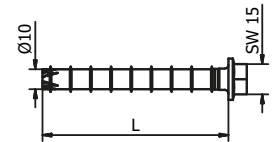

Model 3701	zinc-plated steel (inside)	Model 3701	AISI 316 (exterior)
Sales unit	Art. no.	Sales unit	Art. no.
50	91.3701.090.81	25	91.3701.095.30

## FLEXFIT 1.0 kN



- | Fine adjustment of glass panes
- | For glass thicknesses between 12 - 21.52 mm
- | Adjustment of up to 34 mm in relation to the vertical axis
- | Pay attention to the right glass thickness!

Length		2500 mm	5000 mm	25 mtr
Glass thickness	Wedge colour	Art. no.	Art. no.	Art. no.
12 mm	black	90.0502.112.00	90.0505.112.00	90.0525.112.00
6/6/2 (12.76 mm)	red	90.0502.113.00	90.0505.113.00	90.0525.113.00
6/6/4 (13.52 mm)	grey	90.0502.114.00	90.0505.114.00	90.0525.114.00
15 mm	yellow	90.0502.115.00	90.0505.115.00	90.0525.115.00
<b>8/8/2 (16.76 mm)</b>	red	90.0502.117.00	90.0505.117.00	90.0525.117.00
<b>8/8/4 (17.52 mm)</b>	green	90.0502.118.00	90.0505.118.00	90.0525.118.00
19 mm	blue	90.0502.119.00	90.0505.119.00	90.0525.119.00
<b>10/10/2 (20.76 mm)</b>	red	90.0502.121.00	90.0505.121.00	90.0525.121.00
<b>10/10/4 (21.52 mm)</b>	green	90.0502.122.00	90.0505.122.00	90.0525.122.00