

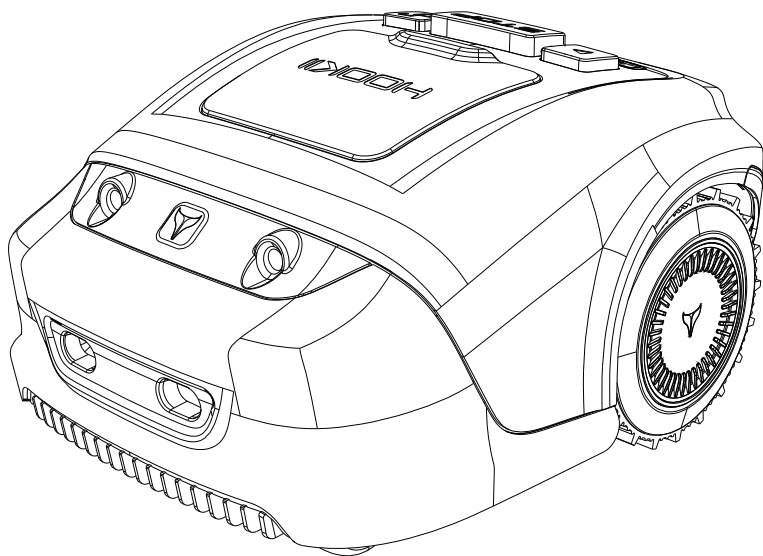

HOOKII



Neomow S

EN | User manual



EN | English

Original instructions



Neomow S

User manual

Read the User Manual carefully before use.

Make sure you understand all the instructions and safety warnings.

Keep for future reference.

Content

Welcome	2
Safety Warnings	2
Important	2
Operation	3
Preparation	4
Maintenance and Storage	4
Symbols and Decals	5
Introduction	6
Package Contents	6
Description of Product	7
Installation	8
App Installation	8
The Charging Station Installation	9
Connect the charging station to the Boundary Wire	13
Operation	13
Control Panel	13
Basic Operation	14
Charging and Testing	15
Signal Selection	15
Technical Data	16
Maintenance and Storage	18
Maintenance	18
Cleaning the Mower	19
Reversing or Replacing the Blades	20
Software Update	20
Recycling and End-of-life Disposal	20
Troubleshooting	21
Limited Warranty	24
Contact Us	25

Welcome

Thank you for choosing Neomow S (referred to as 'the mower' or 'robotic mower' in the manual).

Your robotic mower is designed to mow grass in ground areas where the slope less than 18°. Collection of grass is not necessary because the fine grass clippings serve as a natural fertilizer. You can enjoy the fun of carefree mowing and always keep a perfectly maintained lawn. Furthermore, it is emission free, convenient, hands-free and you can have a sound sleep while the mower is working! Let this robotic mower housekeeper take care of your lawn!

Safety warnings

Important

- Read all safety warnings and all instructions. Make yourself familiar with the controls and the proper use of the machine. Please keep the instructions safe for later use.
- Operate the ON/OFF switch before working on or lifting the machine to make sure you have turned it off.
- DO NOT touch rotating blades that can cause injury. The blades are sharp. Beware of severing toes or fingers. Wait until the machine completely stopped before touching them.
- Keep a safe distance to the product when operating, and make sure that bystanders are not injured by foreign objects being thrown away.
- DO NOT ride on the machine. Children should be supervised to ensure that they do not play with the machine.
- DO NOT dispose of this product at will. It can cause injury to the environment.
- Ensure no exits are blocked or obstructed by the machine.
- DO NOT leave the machine to operate unattended if you know that there are pets, children or people in the vicinity.
- Carefully check the area where the tool is to be used for wildlife and pets. Wildlife and pets may be injured while the machine is in operation. Thoroughly check the working area and remove any stones, sticks, wires, bones and foreign objects. When using the machine, ensure that no wildlife,

pets or small tree stumps are hidden in the dense grass. Avoid using at dusk or in the dark to reduce the risk of encountering animals.

Operation

- Read the instructions carefully. Be familiar with the controls and the proper use of the machine.
- The operator or user is responsible for accidents or hazards occurring to other people or their property.
- NEVER allow children, persons with physical, sensory or mental limitations or a lack of experience and /or knowledge and/or people unfamiliar with these instructions to use the product. Local regulations may restrict the age of the operator.
- If the mower makes an abnormal sound or signals an alarm, press the STOP button immediately.
- DO NOT modify the mower by yourself. Modifications could interfere with mower operations, result in serious injury /damage, and void the Limited Warranty. Use only **HOOIKII** approved parts and accessories.
- DO NOT touch moving hazardous parts before the mower has come to a complete stop.
- When carrying the lawn mower, turn it off and carry it as explained in this manual with the blades facing away from you.
- DO NOT use automatic lawn watering systems while the lawn mower is operating, because the watering equipment may get damaged and the likelihood of water penetrating into the lawn mower is greatly increased. Adjust the work time of the lawn mower so that the watering systems and the lawn mower do not operate at the same time.

Preparation

- Periodically inspect the area where the machine is to be used and remove all stones, sticks, wires, bones, and other foreign objects. The Limited Warranty does not cover damages caused by objects left on the lawn.

- DO NOT run any live mains cables in the working area. If a mains cable becomes entangled in the robotic mower it must be isolated before any attempt to remove it.
- Ensure the correct installation of the charging station and boundary wire as instructed in this manual.
- Before each mowing session, check that all parts of the mower can function normally. DO NOT use the lawn mower if the outer casing is damaged. The blade may accidentally cut you or you may be injured by debris thrown off by the blades.
- Avoid mowing in bad weather conditions especially when there is a risk of lightning, heavy rain or snow. It is recommended to mow in dry weather.
- DO NOT operate the machine when barefoot or wearing open sandals. Always wear substantial footwear and long trousers.
- Warning signs shall be placed around the work area if the product is used in public areas. The signs shall have the following text: Warning! Automatic lawn mower! Keep away.

Maintenance and Storage

- Operate the machine in a suitable ambient temperature to avoid that low/high temperatures decrease mower performance and even lead to accidents.
- Regularly check the machine to keep all nuts, bolts, and screws tight , be sure of the machine is in safe working condition.
- Replace worn or damaged parts for safety. Ensure that the replacement is the matching type.
- DO NOT place anything on the mower or the charging station.
- DO NOT modify this product. Unauthorized modifications may impair the safety of your product and may result in increased noise and vibration.
- Ensure that batteries are charged using the correct charger recommended by the manufacturer. Improper use may cause electric shock, overheating, or leakage of corrosive liquid.

- During the winter season once the temperature is consistently below 5 °C, store the mower and the docking station in a secure, dry place, out of the reach of children.
- Operate and store the mower only within a temperature range between 0 °C and 40 °C. Too high temperatures can cause damage to the product. As an example, do not leave the mower in the car in summer.

Symbols and Decals

Please study the symbols on the product and labels carefully and understand their meaning:



WARNING-Read instruction manual before operating the machine.



WARNING-Keep a safe distance from the machine when operating.



WARNING-DO NOT touch rotating blade.



WARNING-DO NOT ride on the machine.



WARNING-Operate the disabling device before working on or lifting the machine.



Guaranteed sound power level value in 62 dB(A)

Introduction

Package Contents

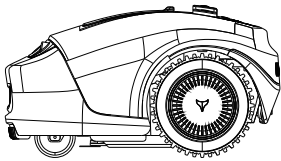

Robotic Mower

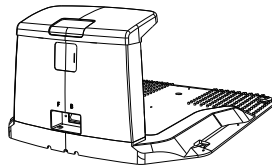

Charging station

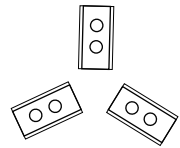

Spare blades

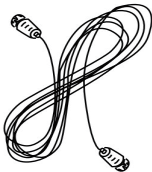

Extension cord



Switching Power Supply

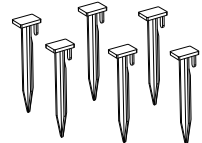

Wire pegs



Boundary wire

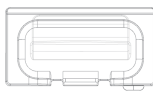

Charging station
rubber plug

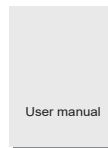

User manual

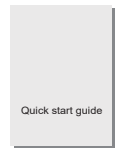

Quick start guide

Description of Product

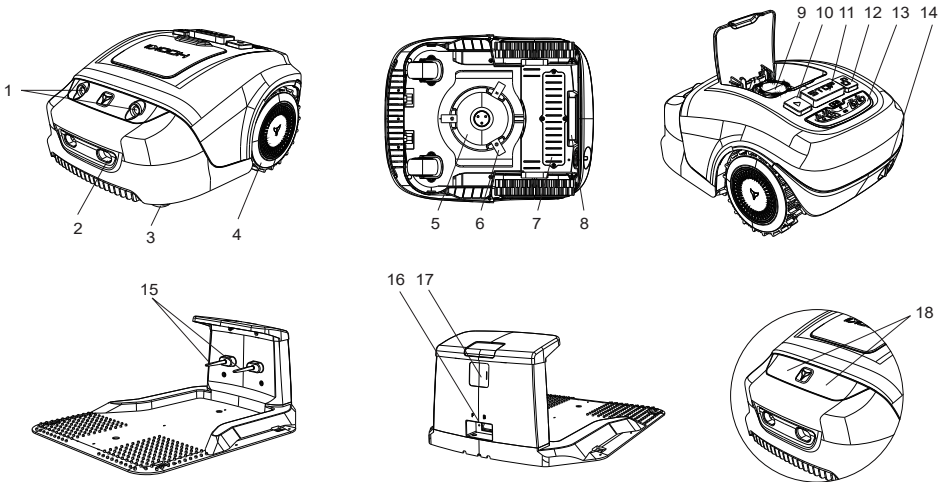

- | | | |
|--|----------------------------------|------------------------------|
| 1.Ultrasonic sensors | 2.Charging port | 3.Front wheel |
| 4.Rear wheel | 5.Blade disc | 6.Blade |
| 7.Battery compartment | 8.Handle | 9.Cutting height adjust knob |
| 10.Start button | 11.Stop button | 12.Unlock button |
| 13.Control panel | 14.ON/OFF switch | 15.Charging pins |
| 16.Terminal for perimeter wire | 17.Docking station control panel | |
| 18.Neomow S have another choice which without Ultrasonic sensors | | |

- * Cutting height adjust knob – Adjust the height of the blade disc to set the height of your lawn
- * Start button – Start the mower (First START button, then OK button:Abnormal removal, continue to work)
- * Stop button – Stop the mower
- * Unlock button – Interlock with STOP button, press this button will unlock the stop model.
- * Wire connector-Connect/Add twire to your original perimeter wire layout or to add an inner boundary.

Installation

Please make a clean of your lawn, make sure there are no stones, no sticks, no wires, no bones, and other foreign objects in your lawn.

Note:

The mower can navigate slopes up to a maximum of 33% or 18° incline or decline. Take care of the objects that are less than 100mm high, remove them or mark them.

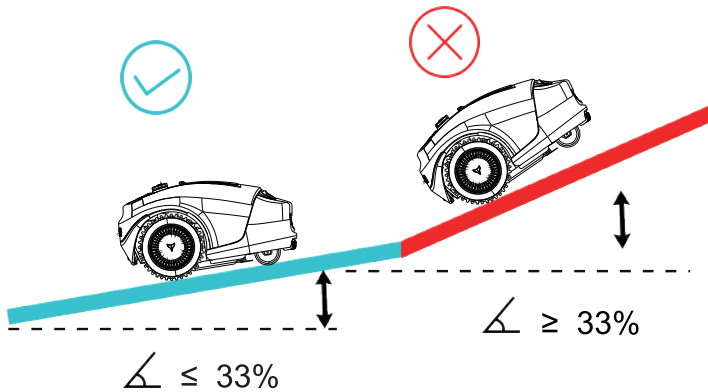

App Installation



To ensure a successful setup, please scan the QR code to download the **HOOKII** app. Alternatively, go to the Google Play Store (Android) or the Apple App Store (iOS) and search "**HOOKII**". After installing the app, please follow the APP guidelines. There are two ways to connect the APP:

1.Via Bluetooth

Make sure your phone's Bluetooth is on, and keep the mower within 10m.

2.Via WiFi/4G

Make sure the WiFi/4G that your phone connected is WiFi/4G instead of 5GHz. Make sure the WiFi/4G signal is available in the garden. It is necessary to connect the Bluetooth icon before setting up the WiFi/4G connection. Connect both the mower and your mobile to your WiFi/4G network.

The Charging Station installation

Choose a suitable position for the charging station

Install the charging station on a soft and flat surface. Do not place the charging station too close to a slope, such as at the top of a hill or the bottom of a furrow. Avoid left and right inclination in excess of 5 degrees. Once the position of the charging station is confirmed and mains electrical connection is laid out, please do not connect to main power yet. Finish all boundary layout work before connecting the charging station to the power supply.

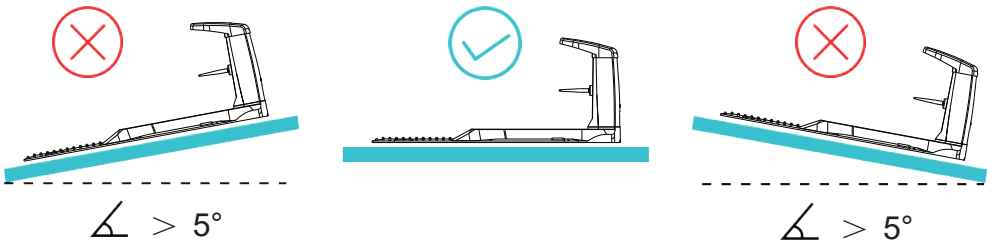

Note:

After the layout of boundary wire, it is needed that connect the charging station to the boundary wire. And after testing drive, auto-charge successfully indicates that a suitable position for charging is found. Now drive fixing pegs into ground fully. The mower will only automatically return to the charging station counter-clockwise. The mower receives direct sunlight for a prolonged period of time and the battery will get too hot and not function correctly.

Pegging the boundary wire in a clockwise direction

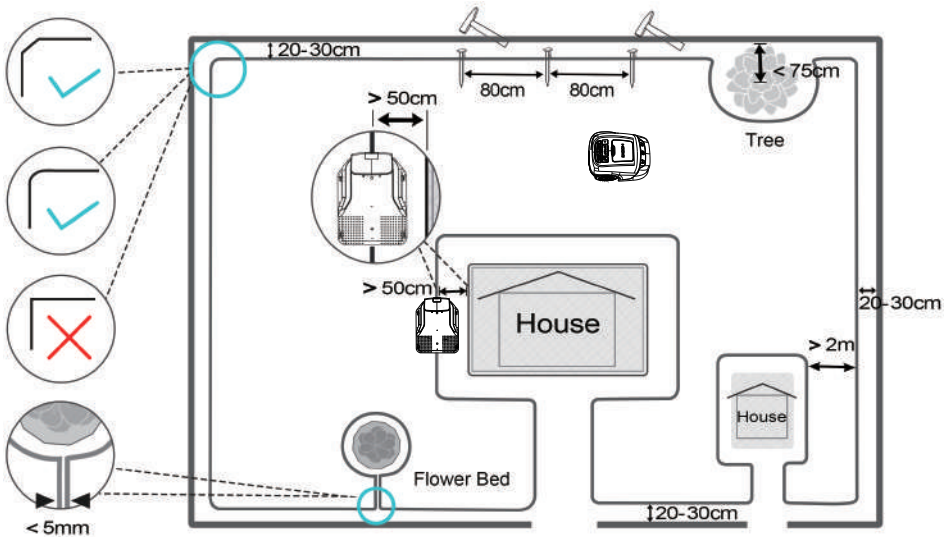

1. Strongly recommend mowing the lawn grass to 60mm or less before laying out the boundary wire.
2. And the recommended distance between two pegs is about 80cm in straight lines (less in tight curves). Note that the pegs' hook and wire slit always face the outside of the boundary. First plant the pegs, do not drive them fully into the ground.
3. Use the boundary wire distance gauge to set the correct distance between the wire and the border of your lawn (20-30cm). The further the two are from each other, the lower chances of bad situations.
4. Encircling obstacles: roots, ponds, flowerbeds, landscape stone ect. This will prevent your robotic mower colliding with objects or going straight into them. Exclude any pools from the cutting area. For added safety, we recommend placing a fence around the pool.

- a. Run the wire from the lawn perimeter to the object.
- b. Continue circle around the objects in a clockwise direction. When going around the object use more pegs. Remember to leave 30cm around the object to the wire!
- c. Return the wire back to the perimeter (Note: the distance between two wires requires less than 5mm and do not cross over the wires at any point). Ensure the distance from the wire around the object and lawn perimeter is at least 75cm (if less than 75cm surround the object when installing the wire, leaving the object outside of the lawn cutting area).

5. Others

Paths, Driveways and Roads

If an elevated driveway crosses your lawn, better keep it outside the boundary wire. Please allow a safety distance of 30cm between the driveway and the boundary wire.

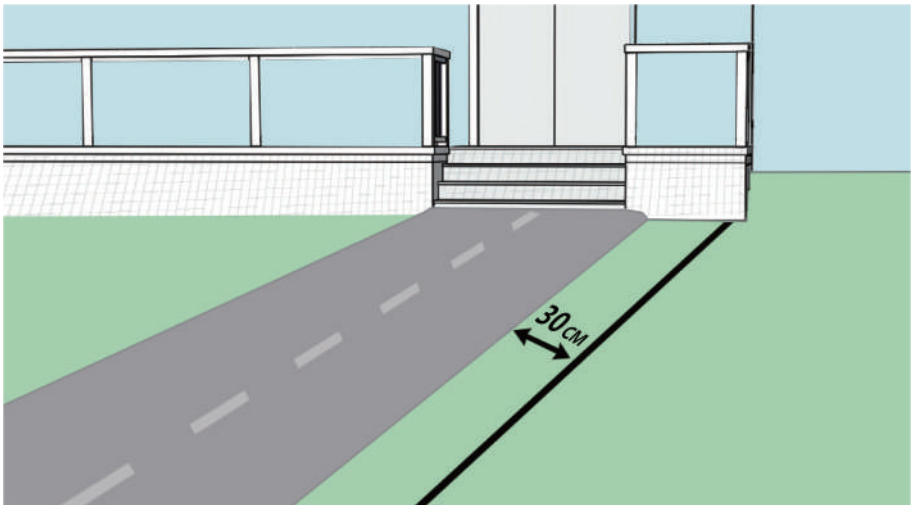

If the driveway and lawn are at the same level, feel free to use the boundary wire to create a corridor. This allows your robotic mower to cross the driveway and reach the opposite lawn.

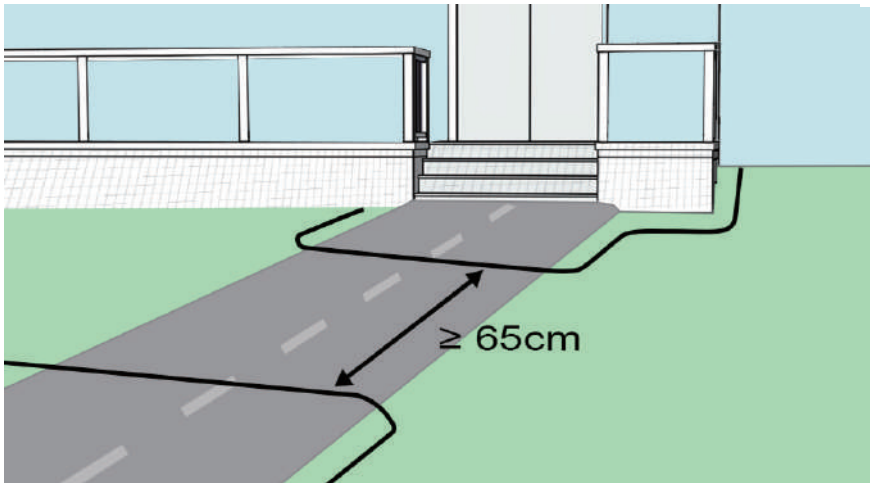

If your neighbour is using the same mower, it will need to keep a distance of 0.5m away from your neighbour's boundary wires to prevent the two devices interfering with each other. Ensure to position your charging station at least 10m away from your neighbour's boundary wires. Make it clearly that your mower and your neighbour's are using different signal (See below for more information).

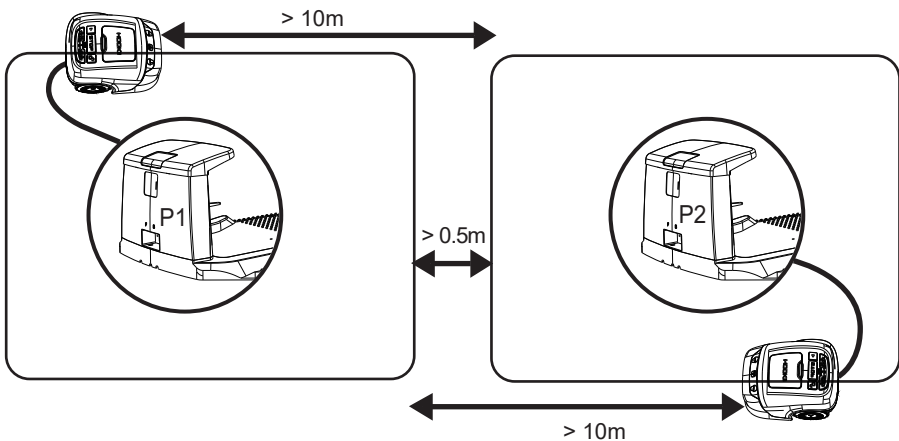

Uneven lawn surfaces : We recommend leveling the lawn before using your robotic mower or excluding uneven areas with the boundary wire.

Connect the charging station to the Boundary Wire

Place the docking station at the end of the boundary wire so that the wire runs lengthwise below the middle of the docking station. Connect that end to the left (black) connector marked "F" (front). Connect the other end to the right (red) connector marked "B" (back). Once the P1 or P2 LED confirms, it means the connection is successful

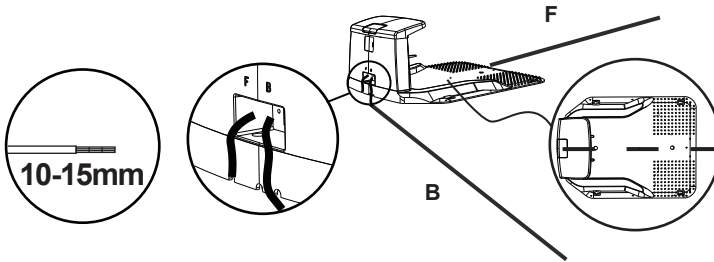

Operation

Once the relevant preparations have been made, learn how to control your mower!

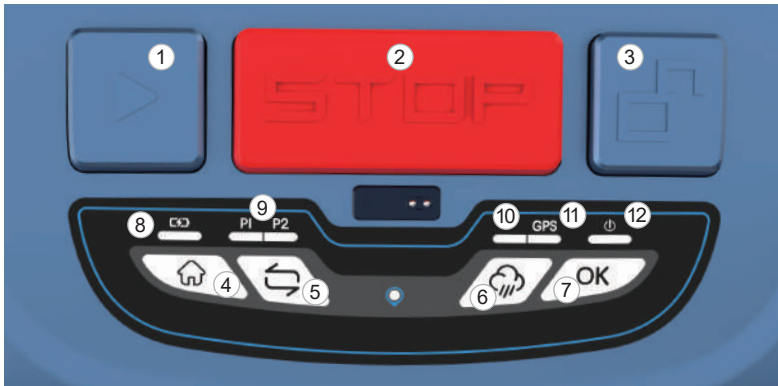

- **START button** ^① Start the mower (First START button ^①, then OK button ^⑦: Abnormal removal, continue to work)
- **STOP button** ^② Press this button, the mower will stop immediately.
- **Unlock button** ^③ Interlock with STOP ^② button, press this button will unlock the stop model.
- **HOME button** ^④ First HOME button ^④, then OK button ^⑦: the mower will return to charging station.

- Signal select button^⑤ Select signal either P1 or P2.
- Rain sensor button^⑥ Switch rain sensor On/Off. LED remain on to allow working in the rain; Lights out, no work in the rain.
- OK button^⑦ Used with the Start/Home button.
- Charging indicator^⑧ LED will flash when the robotic mower is charging.
- Signal indicator^⑨ LED will remain on when the P1/P2 is selected.
- GPS signal indicator^⑪ LED will remain on only when the GPS signal is normal.
- Power indicator^⑫ LED will remain on when the ON/OFF switch is on.

Basic Operation

1. Start mowing

Press Unlock button^③, START button^① and OK button^⑦ in order, then the mower will start mowing.

2. Return to charging station

Press unlock button^③, then press HOME button^④ and OK button^⑦

3. Stop the robotic mower

It is allowed to stop your robotic mower by pressing the STOP button in any situations. The stop button has the highest priority, the robotic mower will stop immediately in any case.

4. Cutting height adjustment

The cutting height can be adjusted by rotating the height adjustment knob. Cutting height range from 20mm- 55mm.

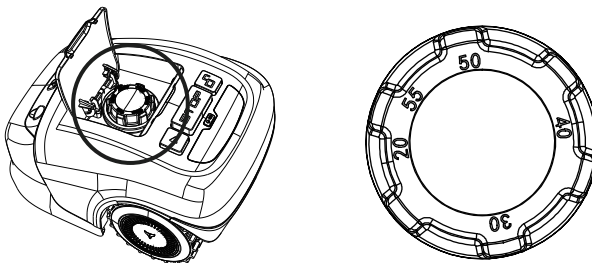



Charging and Testing

After the successful connection of the charging station and boundary wire , test the robotic mower's function. (If the mower is too power-low to start, place the mower in the charging station. Make sure the charging is successful.)

Check the LED regularly to ensure fixing the boundary wire has not affected the connection and signal shows P1 on the charging satation.

Then place the mower in the working area, a few meters beside the docking station. Set the main power switch to "ON".

Press the buttons  home  and OK  in order, a few seconds later, the mower should automatically return to the charging station by locating and following the boundary wire in anti-clockwise direction. If the mower fails to dock correctly move the docking station to a more suitable location.

Note:

Successful docking and charging indicates that you have found a suitable position for the docking station. You should now drive the fixing pegs into ground fully.

Signal Selection

There are two signal which can be selected, P1 and P2. Make sure the mower and charging station are using the same signal.

If your neighbour is using the same mower, ensure that both products are using different signals. Please refer to the section of "Signal setting" in order to select signal P1 or P2 for your installation.

Technical Data

Basic Information	Product Name	Neomow S
	Brand	Hookii
	Dimensions: (Length × Width × Height)	48x38x26cm
	Net Weight (Battery Included)	14.4kg
Mower Parameters	Material	Plastic
	Working Capacity (Per Full Charge)	300 m ²
	Typical Mowing Time (Per Full Charge)	150min
Working Conditions	Cutting Width	18cm
	Cutting Height	20-55mm
	Charging Time	150min
	GPS Working Mode	Yes
	Working Temperature	0 °C ~40 °C

	IP Rating	IPX5
	Max. Incline Inside Working Area	18° (33%)
Connectivity	Wireless Connection	Y
	Wi-Fi/Cellular Network	Y
	4G network service (4G)	Y
Driving Motor	Rated Power	60W
	Motor Type	Brushless
Battery Pack	Battery Type	Lithium-Ion
	Nominal Voltage	18V
	Nominal Capacity/Energy	4.4Ah
	Battery cycle times	600
Power adapter	Input Voltage	100-240V~50/60Hz
	Output Voltage	22V
	Output Current	2.5A

Maintenance and Storage

Maintenance that is not mentioned in these instructions must be carried out by a servicing agency authorised by the manufacturer. Only original parts are permitted.

Maintenance

Check and clean your robotic mower regularly and replace worn parts if necessary. Preferably use a dry brush, a damp cloth or a sharpened wooden piece. Never use flushing water. Following these maintenance instructions can extend your robotic mower's service life.

Battery Life

For proper storage of the Li-Ion battery, make sure it is fully charged and kept in a cool dry place. The life span of the battery depends on various factors. For more details, please refer to Technical Data.

Winter Storage

During winter, keep your mower, docking station and power supply in a dry place. We recommend a shed, garage or preferably store them indoors. Prepare your device for winter storage as follows:

1. Fully recharge the battery.
2. Set the mains power switch to "OFF".
3. Deeply clean your robotic mower.
4. Unplug the power supply from the mains outlet.
5. Disconnect the power supply from the charging station.
6. Disconnect the boundary wire from the charging station. Lift up the charging station and clean. The boundary wire can remain outside. However, it is imperative to protect the wire from corrosion. We recommend a water-free grease or suitable sealing tape. If available, repack the product in the original packaging. Alternatively, our service centre offers a winter service for your device, which include a check-up guide of all parts and a software upgrade.

Preparing for spring

After winter storage, please clean the charging contacts on both the mower and the docking station.

Use a fine abrasion paper or a brass brush, which will help to achieve the best charging efficiency and avoid any charging interference.

Cleaning the Mower

Cleaning the mower body:

As your robotic mower is battery powered, you should pay attention when cleaning. Remove rough dirt with a soft brush. Then use a manual water spray with mild household detergent for intensive cleaning. Last, wipe off any residue with a moist rag after cleaning.

Cleaning the underside:

Ensure the main power switch is in OFF position. Wearing protective gloves when handling or working near sharp blades. Turn the robotic mower upside down. Clean the blade disc and frame using a soft brush or damp cloth. Rotate the blade disc to make sure that it can move freely.

Clean the contact pins and the charging strips:

Use wire wool, metal cleaner or very fine grade emery paper, clean the contact pins and the charging strips on your mower and docking station. Remove any debris, leaves, or grass clippings around the contact pins and charging strips to ensure efficient charging.

Reversing or replacing the blades:

WARNING! Ensure the robotic mower is completely shut off for any adjustment or replacement of the blades. Always wear protective gloves.

WARNING! To ensure maximum cutting efficiency and safety, always use recommended original blades and screws when replacing.

Your robotic mower has three blades, fixed to the blades disk. Unless damaged by hard obstacles, these blades can last for up to five months of everyday use. Weekly inspection of the blades and the fixing screws is advised. Note that the blades are double edged. In case the first side becomes blunt, loosen the screw and turn the blade upside down and re-fix. Check that the blade can move freely.

A set of spare blades is included with the package. More blades are available to purchase via customer support or online store.

To ensure the best performance of your machine, always replace all three blades at the same time. Only use spare parts recommended by manufacturer.

Software Update

Should your machine need a software update, contact our customer service team for more information.

Recycling and End-of-life Disposal

DO NOT dispose of this product as domestic waste. For recycling information, contact the local domestic waste service, the local municipality, or the point of sale.

WARNING! DO NOT dispose of this product in a landfill, by incineration, or by mixing with household trash. Danger or serious injury can occur because of the electrical components.

NOTICE: INSURANCE

YOUR INSURANCE POLICIES MAY NOT PROVIDE COVERAGE FOR ACCIDENTS INVOLVING THE USE OF THIS PRODUCT. TO DETERMINE IF COVERAGE IS PROVIDED, PLEASE CONTACT YOUR INSURANCE COMPANY OR AGENT.

Troubleshooting

Type	Error	How to solve
Product	Cannot charge with charging station	<ol style="list-style-type: none"> 1. Check that the boundary wire in front and underneath the charger are in a straight line. 2. Check that whether the charging station's location is suitable as explained in this manual.
	The Mower runs in circles unusually	<ol style="list-style-type: none"> 1. Verify that no power cable runs parallel and in close proximity the boundary wire. If necessary, reposition the boundary wire. 2. Check if a front wheel is stuck. 3. If a neighbor has a similar robotic mower, the signal may be interfered. Try to reset the signal of the charging station and the mower to the alternative boundary signal. 4. Driving motor may be damaged, please contact customer support.
	The mower is noisy	<ol style="list-style-type: none"> 1. Inspect the fixing screw of blades; tighten if necessary. 2. Inspect and replace the blades if necessary. 3. Grass may be too high. Try to increase the cutting height, or mow the lawn with a traditional lawnmower first. 4. Cutting motor failure, please call after sales service.
	No response after pressing START button and OK button	<ol style="list-style-type: none"> 1. Check if the mower has already completed the programmed working time for that day. 2. Press the UNLOCK button

Applicat ion	<p>Wire sensor polarity reversed! The perimeter wire is set in the opposite terminal of the charging station.</p>	<p>Press the “Reset” button. Reset the perimeter wire. See chapter “Encircling obstacles” for details.</p>
	<p>Reconfirm boundaries? The perimeter wire is set wrong which cannot be detected by the mower.</p>	<p>Press the “Confirm” button. Reset the perimeter wire. See chapter “Encircling obstacles” for details.</p>
	<p>Unable to leave ! The mower is in trouble to get through the working area.</p>	<p>Press the “Reset” button. Check if there are any bumps or potholes. DO NOT allow the mower mowing there again before making them flat.</p>
	<p>There are obstacles on the path ! The mower is in trouble with some obstacles on the path.</p>	<p>Press the “Reset” button. Move the obstacles from the path.</p>
	<p>Out ! The mower is not in the boundaries.</p>	<p>Press the “Reset” button. Stop the mower and move the mower into the working area , restart it.</p>
	<p>Boundary inspection time out ! The mower impacting the obstacles causes the walk time out during the recharging procedure.</p>	<p>Press the “Reset” button. Move the obstacles from the recharging path.</p>
	<p>Abnormal power loss ! The battery of the mower is losing power.</p>	<p>Press the “Reset” button. Recharge the mower.</p>

Applicat ion	Mower has been flipped !	Stop the mower and rotate the mower, restart it.
	Left-wheel motor failure !	Stop the mower and contact the specialist to repair it.
	Right-wheel motor failure !	Stop the mower and contact the specialist to repair it.
	Wired sensor signal loss!	Stop the mower and contact the specialist to repair it.
	Emergency stop!	Press the “Reset” button. Restart the mower.
	Location error !	Restart the mower.
	Mowing Motor failure !	Stop the mower and contact the specialist to repair it.
	Battery temperature too high !	Stop the mower and wait 40min at least to restart the mower.
	Mower lifted !	The mower is lifted to check for foreign objects at the bottom.

Limited Warranty

NOTICE: PLEASE READ THIS LIMITED WARRANTY AND ARBITRATION AGREEMENT AND KEEP THIS AGREEMENT FOR FUTURE REFERENCE.

This Limited Warranty covers only defects of any material or quality of the Product and components when the Product and components thereof are being used under normal and ordinary conditions. In the event that a defect covered by this Limited Warranty occurs, Hookii and/or other Hookii Parties in its sole discretion will repair or replace the defective Product or components thereof in accordance with this Limited Warranty. The applicable Limited Warranty Period for the Limited Warranty commences on the date of the original purchase of the Product from either of Hookii, Hookii's authorized reseller, Hookii's authorized distributor, or an authorized Dealer (each a "Hookii Dealer" or collectively the "Hookii Dealers").

	Limited Warranty Period
Mower Body	2 year
Battery	1 year

Contact Us

Manufacture:

Name: Orca Innovation Technology Co., Ltd

Address: Room 2703, Building B, Block 7, Shenzhen International Innovation
Valley Dashi 1st Road, Xili Community, Xili Street, Nanshan District
Shenzhen, China

Website: <https://www.hookii.com>

Contact us if you experience issues relating to the operation, maintenance and safety, or errors/faults with your mower.

Original instructions

Original instructions

EC Declaration of Conformity

We herewith declare,

Orca innovation technology Co.,Ltd

Room 2703, Building B, Block 7, Shenzhen International Innovation Valley Dashi 1st Road, Xili Community Xili Street, Nanshan District, Shenzhen, China

that the following machine complies with the appropriate basic safety and health requirements of the EC Directive based on its design and type, as brought into circulation by us.

In case of alteration of the machine, not agreed upon by us, this declaration will lose its validity

Machine Description:	Robotic mower
Machine Type:	M18E-0XXX
Trade name :	N/A
Serial Number :	See marking
Ratings:	18Vd.c.
Applicable EC Directives:	EC Machinery Directive 2006/42/EC EMC Directive 2014/30/EU Noise directive 2000/14/EC Annex V & 2005/88/EC Measured sound power level : 60.77 dB(A) Guaranteed sound power level : 62 dB(A)
Applicable Harmonized Standards:	EN 60335-1: 2012 + A11: 2014 + A13: 2017 + A1: 2019 + A14: 2019 + A2: 2019+A15: 2021 EN 50636-2-107: 2015 + A1: 2018+ A2: 2020+A3:2021 EN 55014-1:2017 EN 55014-2:2015 EN55014-1:2006+A1+A2
Name and address of the person authorised to compile the technical file who must be established in the Community:	To be advised Name and address of the person authorised to compile the technical file, must be established in the EU
Authorized Signature/Date/ Place:	Name: Chen Yicheng Date:2022-11-30 Place: Shenzhen

