



- (E) OWNER'S MANUAL**
- (F) MANUEL DU PROPRIÉTAIRE**
- (D) BEDIENUNGSANLEITUNG**
- (I) USO E MANUTENZIONE**
- (ES) MANUAL DEL PROPIETARIO**
- (P) MANUAL DO PROPRIETÁRIO**



⚠ Read this manual carefully before operating this machine.

⚠ Il convient de lire attentivement ce manuel avant la première utilisation de la machine.

⚠ Bitte lesen Sie diese Bedienungsanleitung sorgfältig durch, bevor Sie die Maschine in Betrieb nehmen.

⚠ Leggere attentamente questo manuale prima di utilizzare questa macchina.

⚠ Lea este manual atentamente antes de utilizar este equipo.

⚠ Leia este manual cuidadosamente antes de conducir a máquina.

EF2200iS



OWNER'S MANUAL



 Read this manual carefully before operating this machine.

EF2200iS

 **Read this manual carefully before operating this machine. This manual should stay with this machine if it is sold.**

E

EC Declaration of Conformity

We YAMAHA MOTOR POWERED PRODUCTS CO., LTD.
242-2 Sakagawa, Kakegawa, Shizuoka, Japan

declare in sole responsibility, that the products **ENGINE DRIVEN LOW POWER GENERATING SETS**
EF2200iS (7PC-0300101-7PC-0309999)

Directive; Machinery Directive (MD) : 2006/42/EC
Using the following harmonized standards ; EN ISO 8528-13:2016

Directive; Noise Directive:2000/14/EC				
Notified body:	Compliance procedure:	Measured sound power level:	Guaranteed sound power level (L _{WA}):	Rated output:
Aboma bv - Galvanistraat 1,P.O.Box 141,NL-6710 BC Ede	Appendix VI.	91 dB(A)	91 dB(A)	1,800 W

Directive; Electro Magnetic Compatibility Directive (EMC) : 2014/30/EU
Using the following harmonized standards ; EN55012:2007/A1:2009, EN55014-2:1997/A2:2008
Directive; RoHS Directive: 2011/65/EU
Using the following harmonized standards ; EN50581:2012

Authorized Representative
YAMAHA MOTOR EUROPE N.V.
Koolhovenlaan 101, 1119NC Schiphol-Rijk, The Netherlands
242-2 Sakagawa, Kakegawa, Shizuoka, Japan

General Manager Engineering Div. Power Products Operations 
Hiroyuki Tsunekawa

Introduction

Congratulations on your purchase of your new Yamaha.

This manual will provide you with a good basic understanding of the operation and maintenance of this machine.

If you have any questions regarding the operation or maintenance of your machine, please consult a Yamaha dealer.



PLEASE READ AND UNDERSTAND THIS MANUAL COMPLETELY BEFORE OPERATING THE MACHINE.

TIP

- Yamaha continually seeks advancements in product design and quality. Therefore, while this manual contains the most current product information available at the time of printing, there may be minor discrepancies between your machine and this manual. If there is any question concerning this manual, please consult a Yamaha dealer.
 - This manual should be considered a permanent part of this machine and should remain with this machine when resold.
-

* Product and specifications are subject to change without notice.

EF2200iS

OWNER'S MANUAL

**©2019 by Yamaha Motor Powered
Products Co., Ltd.**

1st Edition, August 2019

All rights reserved.

**Any reprinting or unauthorized use
without the written permission of**

**Yamaha Motor Powered
Products Co., Ltd.**

is expressly prohibited.

Printed in China

Important manual information

Particularly important information is distinguished in this manual by the following notations.



This is the safety alert symbol. It is used to alert you to potential personal injury hazards. Obey all safety messages that follow this symbol to avoid possible injury or death.



A **WARNING** indicates a hazardous situation which, if not avoided, could result in death or serious injury.



A **NOTICE** indicates special precautions that must be taken to avoid damage to the machine or other property.

TIP

A **TIP** provides key information to make procedures easier or clearer.

Contents

Safety information	1-1	Starting the engine	4-1
General safety information	1-1	Stopping the engine	4-3
Exhaust fumes are poisonous	1-2	Connecting devices via Alternating Current (AC) receptacles	4-4
Fuel is highly flammable and poisonous	1-2	Connecting devices via the accessory socket	4-6
Engine and muffler may be hot	1-3	Application range	4-7
Electric shock prevention	1-3	High altitude operation	4-8
Connection notes	1-4	Periodic maintenance	5-1
Connection	1-4	The importance of maintenance	5-1
Extension cord notes	1-5	Check before use	5-1
Location of important labels	1-6	Maintenance chart	5-1
Controls and features	2-1	Engine oil replacement	5-3
Description	2-1	Spark plug inspection	5-5
Control function	2-5	Air filter cleaning	5-9
Engine switch	2-5	Muffler screen and spark arrester cleaning	5-12
Oil level warning light (Red)	2-5	Fuel tank strainer cleaning	5-14
Fuel tank cap	2-5	Carburetor adjustment	5-14
Ground (earth) terminal	2-6	Storage	6-1
Economy control switch	2-6	Drain the fuel	6-1
Power supply display	2-6	Engine	6-3
Overload indicator light (Red)	2-7	Trouble recovery	7-1
Reset button	2-7	Troubleshooting	7-1
Fuel tank cap air vent lever	2-7	Specifications	8-1
Fuel level gauge	2-8	EF2200iS	8-1
Hour meter	2-8	Consumer information	9-1
Boost mode switch	2-9	Machine identification	9-1
Twin Tech (parallel running terminal)	2-9	Identification number records	9-1
Accessory socket	2-10	Wiring diagram	10-1
AC receptacle	2-10	Index	11-1
Carburetor fuel drain cock	2-10		
Recoil starter	2-11		
Before operation	3-1		
Preparation	3-1		
Fuel	3-1		
Engine oil	3-2		
Pre-operation check	3-5		
Operation	4-1		
Precautions for use	4-1		

⚠ Safety information

1

General safety information

- This generator is not designed for on-board use. Do not use it while installed on the vehicle.

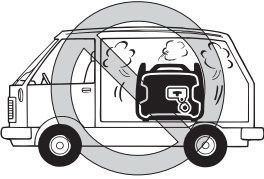

- Do not modify the generator or use it with its parts removed.



- Do not allow children to operate the generator.



- Be sure to carry the generator only by its carrying handle.
1. Carrying handle

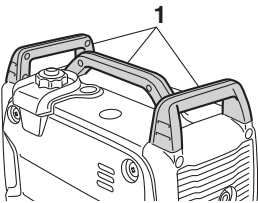

- Do not place any obstacles on the generator.



Exhaust fumes are poisonous



- Using a generator indoors **CAN KILL YOU IN MINUTES**. Generator exhaust contains carbon monoxide. This is a poison you cannot see or smell.
- **NEVER** use inside a home or garage, **EVEN IF** doors and windows are open.
- Only use **OUTSIDE** and far away from windows, doors, and vents.

Fuel is highly flammable and poisonous



- Always turn off the engine when refuelling.
- Never refuel while smoking or in the vicinity of an open flame.
- Take care not to spill any fuel on the engine or muffler when refueling.



- Do not leave the generator inside the vehicle or in the trunk.
- If you swallow any fuel, inhale fuel vapor, or allow any to get in your eye(s), see your doctor immediately. If any fuel spills on your skin or clothing, immediately wash with soap and water and change your clothes.



- When operating or transporting the generator, be sure it is kept upright. If it tilts, fuel may leak from the carburetor or fuel tank.

Engine and muffler may be hot



- Place the generator in a place where pedestrians or children are not likely to touch the machine.

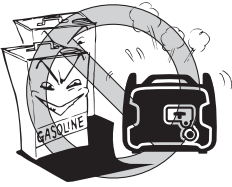

- Avoid placing any flammable materials near the exhaust outlet during operation.

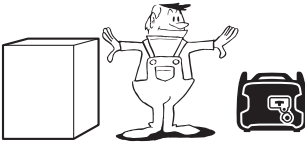

- In order to prevent overheating, ensure adequate air-flow by keeping the machine at least 1 m (3 ft) from objects or other equipment.

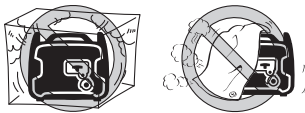

- Do not operate the engine with a dust cover or other objects covering it.
- When covering the generator, be sure to do so only after the engine and muffler have completely cooled down.

Electric shock prevention

- Never operate the engine in rain or snow.





- Never touch the generator with wet hands or electrical shock will occur.

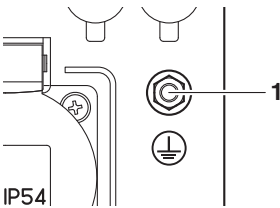

- Connect the ground (earth) terminal to a ground source. In order to prevent electrical shock, the generator must be grounded when using an electrical device with a ground plug.

1. Ground (earth) terminal

Connection notes

- Avoid connecting the generator to commercial power outlet.
- Avoid connecting the generator in parallel with any other generator.

1. Correct
2. Incorrect

Connection

WARNING

Before the generator can be connected to a building's electrical system, a licensed electrician must install an isolation (transfer) switch in the building's main fuse box. The switch is the connection point for generator power and allows selection of generator or main line power to the building. This will prevent the generator from charging the main power line (backfeeding) when the main power supply has failed or has been turned off for line repair. Backfeeding can electrocute or injure line maintenance personnel. Also, generator and building electrical system damage can occur when normal operating power returns if unit is used without an isolation switch.

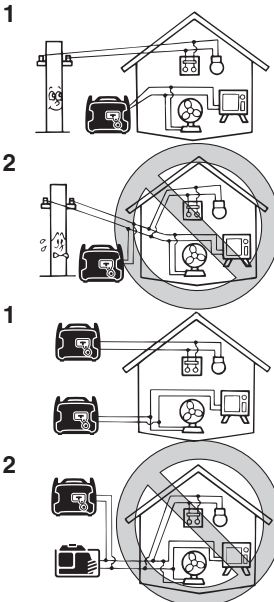



Extension cord notes

Extension cords should be protected by a tough flexible rubber sheath (IEC 245) or the equivalent to withstand mechanical stresses.

Location of important labels

Please read the following labels carefully before operating this machine.



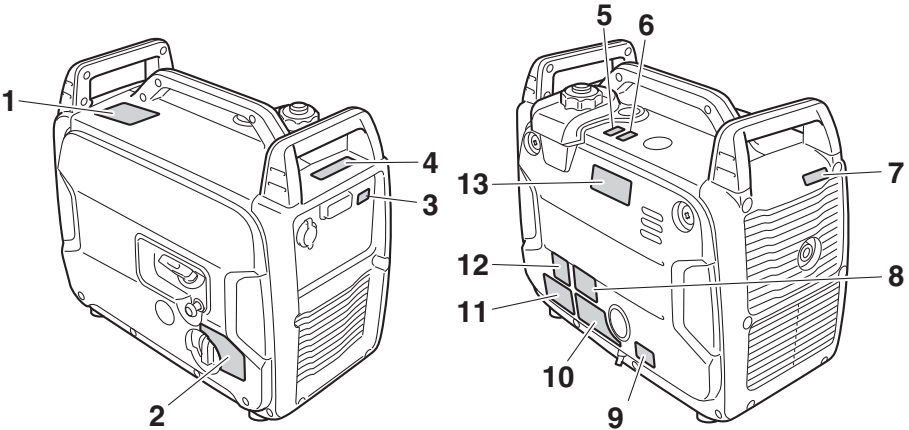

TIP

Maintain or replace safety and instruction labels, as necessary.

For Europe



1

		<ul style="list-style-type: none"> ● STOP THE ENGINE BEFORE REFUELING. BE SURE TO CONNECT ONLY THE SPECIAL CABEL TO THE PARALLEL OPERATION RECEPTACLE. ● ARRÊTER LE MOTEUR AVANT DE FAIRE LE PLEIN DE CARBURANT. NE RACCORDER QUE LE CABLE SPÉCIAL A LA PRISE PARALLELE. ● VOR KRAFTSTOFF-NACHFÜLLEN MOTOR STOPPEN. NUR DAS SPEZIALKABEL AN DIE PARALLEL-BETRIEBSSTECKBUCHSE ANSCHLIESSEN. ● SPEGNERE IL MOTORE PRIMA DI FARE RIFORMENTO DI CARBURANTE. ACCERTARSI DI COLLEGARE ALLA PRESA DI FUNZIONAMENTO IN PARALLELO SOLO IL CAVO SPECIALE. ● STOP DE MOTOR AL VORENS TE TANKEN. SLUIT ALLEEN EEN SPECIALE KABEL AAN OP HET PARALLELBEDRIJFSTOPCONTACT. ● PARE EL MOTOR ANTES DE REPOSTAR. ASEGÚRESE DE CONECTAR SÓLO EL CABLE ESPECIAL A LA TOMA DE CORRIENTE EN PARALELO. ● ΣΤΑΜΑΤΗΣΤΕ ΤΟΝ ΚΙΝΗΤΗΡΑ ΠΡΙΝ ΠΡΟΣΘΕΣΤΕ ΚΑΥΣΙΜΟ. ΣΥΝΔΕΣΤΕ ΜΟΝΟ ΤΟ ΕΙΔΙΚΟ ΚΑΒΛΙΟ ΣΤΟ ΔΟΧΕΙΟ ΠΑΡΑΛΛΗΛΗΣ ΛΕΙΤΟΥΡΓΙΑΣ. ● STOPP MOTOREN FØR DU FYLLER BENSIN. PLUGG BARE SPESIALKABELN I KONTAKTEN FØR PARALLELDRIFT.
		

7PB-F316Z-00

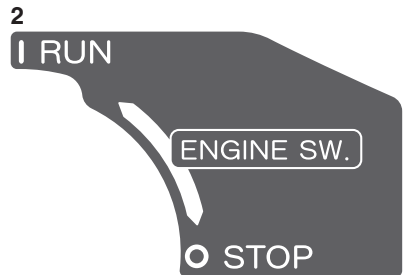

4



7PC-H432R-00

PARALLEL OPERATION RECEPTACLE
PRISE PARALLELE
PARALLEL-BETRIEBSSTECKBUCHSE
PRESA DI FUNZIONAMENTO IN PARALLELO
PARALLEL-BEDRIJFSTOPCONTACT
TOMA DE FUNCIONAMIENTO EN PARALELO
ΔΟΧΕΙΟ ΠΑΡΑΛΛΗΛΗΣ ΛΕΙΤΟΥΡΓΙΑΣ
KONTAKT FØR PARALLELDRIFT



⚠ Safety information

8



•KEEP "CLOSED"
 •"OPEN" at ENGINE SW.,"STOP"
 •"MANTENIR « CLOSED »
 •Quand « OPEN », ENGINE SW. = pos. « STOP »
 •"CLOSED" HALTEN
 •"OPEN" mit ENGINE SW.,"STOP"
 •"TENERE "CLOSED"
 •"OPEN" con ENGINE SW.,"STOP"
 •"HOLD „CLOSED"
 •"OPEN" bij ENGINE SW.,"STOP"
 •"MANTENER "CLOSED"
 •"OPEN" en ENGINE SW.,"STOP"
 •"ΔΙΑΤΗΡΗΣΗ ΤΗΝ ΣΤΗ ΘΕΣΗ « CLOSED »
 •« OPEN » σε ENGINE SW. « STOP »
 •HOLD "CLOSED"
 •"OPEN" ved ENGINE SW.,"STOP"



7PC-F415H-50

9

APPROVAL NUMBER	YAMAHA
***	***** ****
Engine Production date:
Engine Serial:
**
Engine family:	****
	-**

10

CLOSED ▶



OPEN ▲

11

OIL



YAMAHA MOTOR POWERED PRODUCTS CO.,LTD.
 Low power Generating set
 Groupe électrogène de faible puissance
MODEL (TYP) EF2200iS
 Yr. of Manuf. ****
ISO 8528-Class B and G1

Pmax	2.2kW	Ir	7.8A
PrCOP	1.8kW	==	12V 3A
COS φr	1.0	Mass	25Kg
fr	50Hz	IP23M	
Ur	230V		

7PC-F415B-** PAYS D'ORIGINE CHINE MADE IN CHINA

12

CE

242-2
SAKAGAWA
KAKEGAWA
SHIZUOKA
JAPAN



LWA

**** * dB**

YAMAHA MOTOR POWERED PRODUCTS CO.,LTD. ***-*****

13

**NOTICE LET OP ATENCIÓN ΠΡΟΣΟΧΗ
 FORSIKTIG ATTENTION ATTENZIONE ACHTUNG**

- Use the specified spark plug only.
- Gebruik alleen de voorgeschreven bougie.
- Utilice únicamente la bujía especificada.
- Χρησιμοποιήστε μόνο το καθορισμένο μπουζί.
- Benytt kun den spesifiserte typen tennplugg.
- Recourir exclusivement à la bougie du type spécifique.
- Utilizzare solamente la candela d'accensione specificata.
- Verwenden Sie nur die vorgeschriebene Zündkerze.



**BPR6HS
(NGK)**



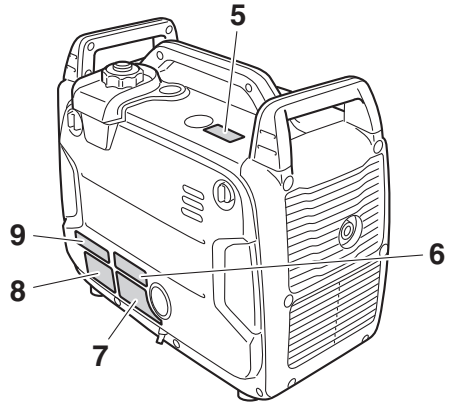
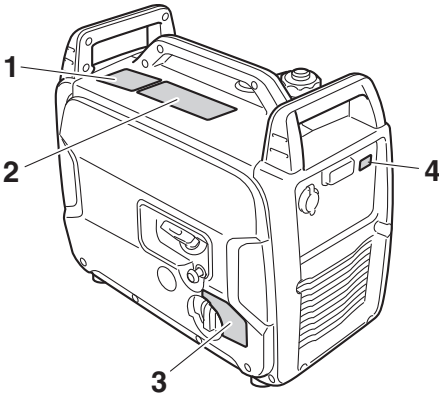

For Australia



1

⚠ WARNING

Using a generator indoors **CAN KILL YOU IN MINUTES.**
Generator exhaust contains carbon monoxide.
This is a poison you cannot see or smell.

			
---	---	---	---

NEVER use inside a home or garage, **EVEN IF** doors and windows are open.

Only use OUTSIDE and far away from windows, doors, and vents. 7PB-F4877-00

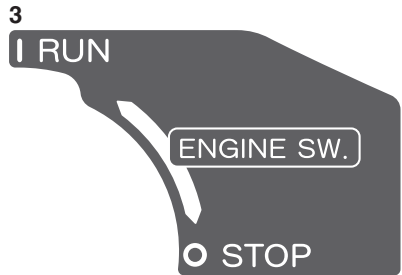

2

⚠ WARNING

- Read the owner's manual and all labels before operating.
- Only operate in well-ventilated areas. Exhaust gas contains poisonous carbon monoxide.
- Check for spilled fuel or fuel leaks.
- Stop engine before refueling.
- Do not operate near flammable materials.
- Electrocutation can occur if generator is used in rain, snow, or near water. Keep this unit dry at all times.
- Electrocutation or property damage can occur: Do not connect this generator to any building's electrical system unless an isolation switch has been installed by a licensed electrician. Refer to the owner's manual.
- When operating the generator:
 - Never place a partition or other barrier around the generator.
 - Do not cover the generator with a box.
 - Do not place any objects on the generator.

7PB-F4162-10

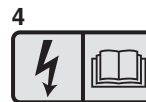

5

NOTICE

Use the specified spark plug only.
Specified plug: BPR6HS (NGK)

Safety information

6

⚠ WARNING



- Before using the carburetor drain cock, turn the engine switch (recoil starter side) to the "STOP" position.
- After draining the fuel, be sure to turn the drain cock lever to the "CLOSED" position.

7PC-F415H-10

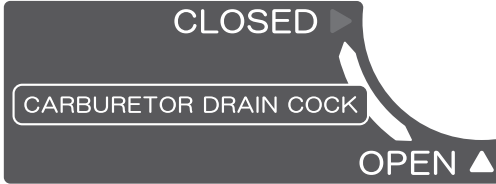
7



8

 OIL 	YAMAHA EF2200iS
	AC output 50Hz Rated 1.8kVA 230V Phase Single DC output 12V 3A Fuel Gasoline
YAMAHA MOTOR POWERED PRODUCTS CO.,LTD. MADE IN CHINA	

7PC-F4164-40

9

EMISSION CONTROL INFORMATION YAMAHA MOTOR CO.,LTD. THIS ENGINE MEETS U.S. EPA EXH / EVP REGS AND CALIFORNIA EXH / EVP SI SORE REGS FOR "EM". EMISSION COMPLIANCE PERIOD : 300 HOURS EP : ***** EVAP F CARB : *****	 YAMAHA EM	The air index of this engine is 3  0 2 4 6 8 10 MOST CLEAN FOR EXTENDED FOR EXTENDED Check owner's manual for further details. No other adjustments needed.
--	--	--

Controls and features

Description

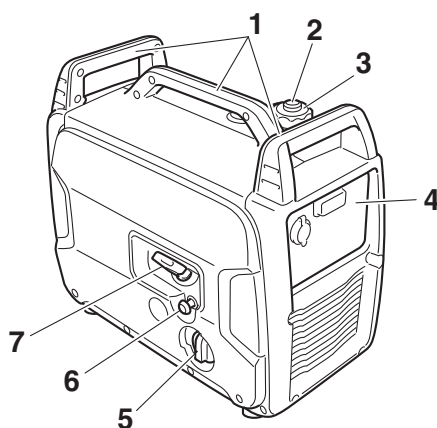

- 1 Carrying handle (p. 1-1)
- 2 Fuel tank cap air vent lever (p. 2-7)
- 3 Fuel tank cap (p. 2-5)
- 4 Control panel (p. 2-1)
- 5 Engine switch (p. 2-5)
- 6 Choke knob (p. 4-1)

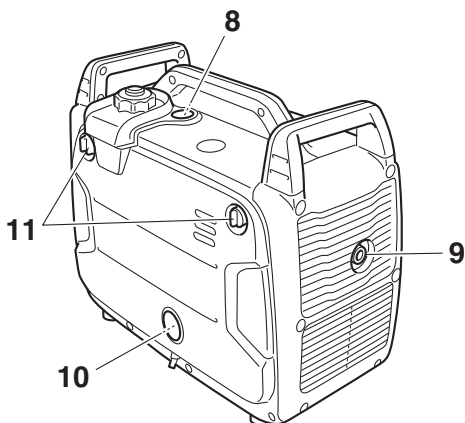

- 7 Recoil starter (p. 2-11)
- 8 Fuel level gauge (p. 2-8)
- 9 Muffler (p. 5-12)
- 10 Carburetor fuel drain cock (p. 2-10)
- 11 Panel opener (for Australia) (p. 3-2)

Controls and features

Control panel

For Europe

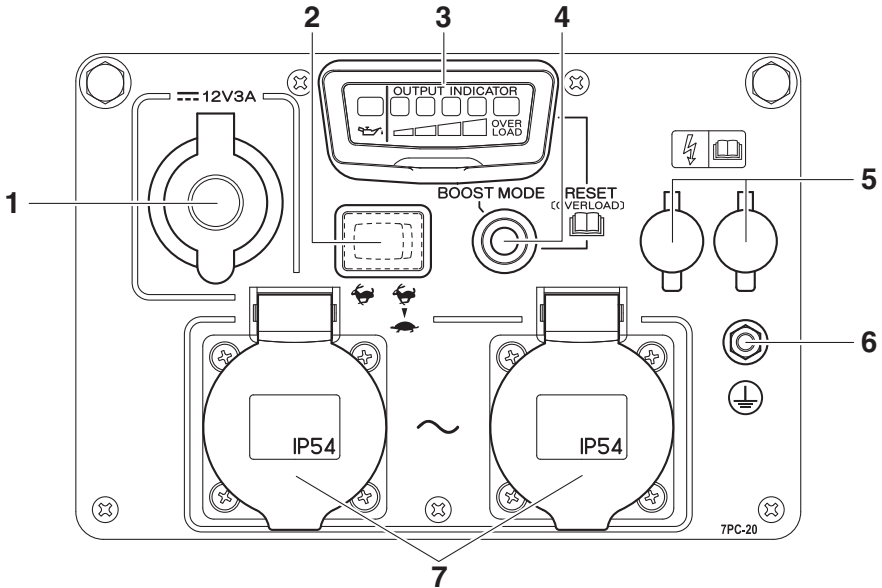

1 Accessory socket (p. 2-10)

2 Economy control switch (p. 2-6)

3 Multi-function LED meter (p. 2-1)

4 Boost mode switch/Reset button
(p. 2-9/p. 2-7)

5 Twin Tech (parallel running terminal) (p. 2-9)

6 Ground (earth) terminal (p. 2-6)

7 AC receptacle (p. 2-10)

For Australia

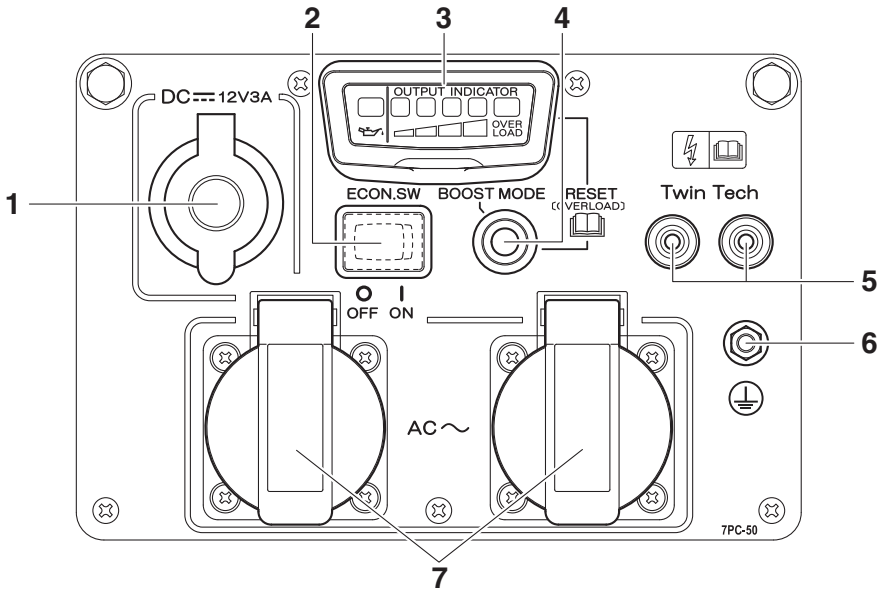

- | | | | |
|---|--|---|--|
| 1 | Accessory socket (p. 2-10) | 5 | Twin Tech (parallel running terminal) (p. 2-9) |
| 2 | Economy control switch (p. 2-6) | 6 | Ground (earth) terminal (p. 2-6) |
| 3 | Multi-function LED meter (p. 2-1) | 7 | AC receptacle (p. 2-10) |
| 4 | Boost mode switch/Reset button (p. 2-9/p. 2-7) | | |

Multi-function LED meter

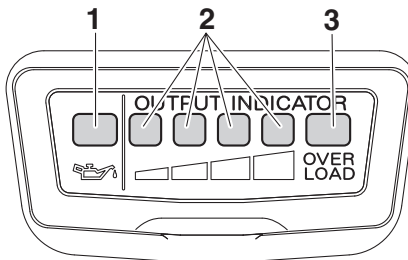

- | | | | |
|---|--|---|---|
| 1 | Oil level warning light (Red) (p. 2-5) | 3 | Overload indicator light (Red) (p. 2-7) |
| 2 | Output indicator (Green) (p. 2-6) | | |

Controls and features

This generator has an integrated multi-function LED meter. Its functions are described as below.

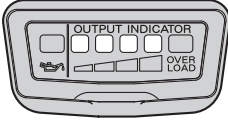
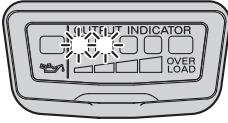
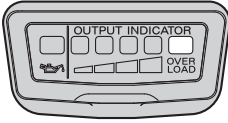
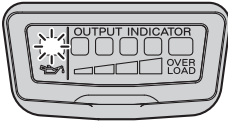
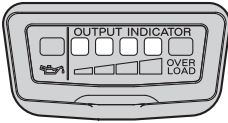
Function	Display	Description	Page
Power supply meter		Output indicator(s) come on according to the current power supply.	2-6
Operating time meter		Output indicator(s) flash according to the accumulated operation time.	2-8
Overload warning		Overload indicator light comes on after output indicators come on, when an overload or some malfunctions of connected devices are detected.	2-7
Oil warning		Oil level warning light flashes when the engine oil level is too low.	2-5
Boost mode		Output indicators come on consecutively when the generator is in boost mode.	2-9

Control function

Engine switch

The engine switch controls the ignition system and the fuel cock.

1. Engine switch
2. "I" (RUN)
3. "O" (STOP)

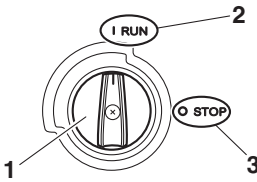

TIP

The engine switch of this generator opens and closes the fuel cock simultaneously. You don't need to operate the fuel cock separately.

"I" (RUN)

Ignition circuit is switched on, and the fuel cock opens. The engine can be started.

"O" (STOP)

Ignition circuit is switched off, and the fuel cock closes. The engine will not run.

Oil level warning light (Red)

When the oil level falls below the lower level, the oil level warning light flashes and then the engine stops automatically. If the light flashes, stop the engine immediately, and add engine oil up to the specified level. Unless you refill with oil, the engine will not start again.

1. Oil level warning light (Red)

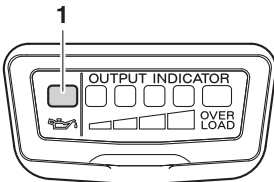

TIP

If the oil level warning light flashes even though the engine oil level is sufficient, make sure to place the generator horizontally.

Fuel tank cap

Remove the fuel tank cap by turning it counterclockwise.

1. Fuel tank cap

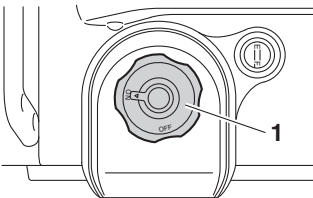

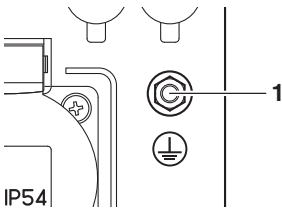

Ground (earth) terminal

Ground (earth) terminal connects the earth line for prevention of electric shock.

When the electric device is grounded, be sure to ground the generator, too.

For the grounding, consult a Yamaha dealer.

1. Ground (earth) terminal

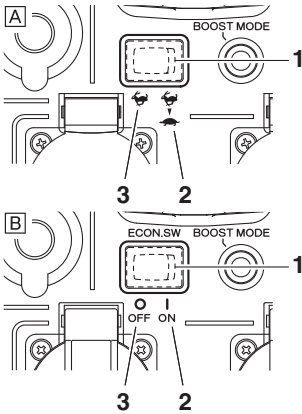

Economy control switch

In order to reduce fuel consumption and operating noise, use the economy control switch.

1. Economy control switch
2. “|”/“👉▶🐢” (ON)
3. “○”/“👉” (OFF)

Ⓐ For Europe

Ⓑ For Australia

“|”/“👉▶🐢” (ON)

When the economy control switch is turned to “|”/“👉▶🐢” (ON), the economy control unit regulates the engine speed according to the connected load. The results are better fuel consumption and less noise.

“○”/“👉” (OFF)

When the economy control switch is turned to “○”/“👉” (OFF), the engine runs at the rated speed (4900 r/min) regardless of whether a load is connected or not.

TIP

- The economy control switch must be turned to “○”/“👉” (OFF) when using electric devices that require a large starting current, such as a compressor or a submersible pump.
- Economy control does not function when the generator is in warming-up period (See page 4-1).

Power supply display

The current power supply level is displayed by the output indicators. According to the power supply level, the output indicator(s) will come on.

1. Output indicator (Green)

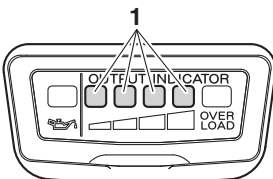

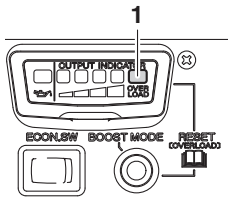

Overload indicator light (Red)

The overload indicator light comes on when electricity over the rated output is required by the connected electrical devices, or when the inverter control unit overheats, or the AC output voltage rises. Then the AC protector will trip, stopping power generation in order to protect the generator and any connected electric devices.

1. Overload indicator light (Red)

TIP

The overload indicator light may come on for a few seconds at the first when using electric devices that require a large starting current, such as a compressor of a submersible pump. However, this is not a malfunction.

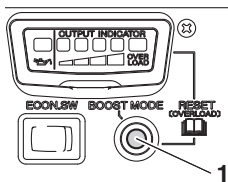

Reset button

If an overload has been detected, the circuit breaker has activated, and the generator output has been stopped, stop any connected electrical devices and hold the reset button for 3 seconds.

The breaker will be reset and the output will resume.

1. Reset button

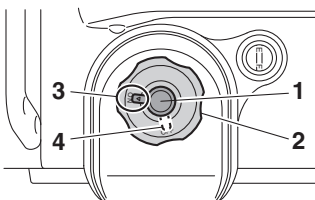

Fuel tank cap air vent lever

The fuel tank cap is provided with an air vent lever to stop fuel flow.

The air vent lever must be turned to “ON” to run the engine.

1. Air vent lever
2. Fuel tank cap
3. “ON”
4. “OFF”

“ON”

This will allow fuel to flow to the carburetor and the engine to run.

“OFF”

When the engine is not in use, turn the air vent lever to “OFF” to stop fuel flow.

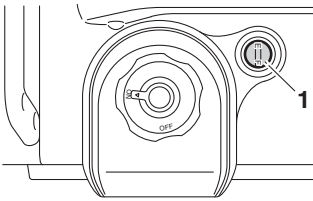

Fuel level gauge

The fuel level gauge shows the amount of the fuel in the fuel tank. Make sure that sufficient fuel is in the fuel tank before the operation.

1. Fuel level gauge

TIP

For European customers:

- This mark identifies the recommended fuel for this machine as specified by European regulation (EN228).
 - Check that gasoline nozzle has the same identifier when fueling.
-

Hour meter

The accumulated operation time is displayed by output indicator lights "A" and "B".

To see the time, push the reset button 3 times within 1 second in no-load running.

1. Output indicator light "A"
2. Output indicator light "B"
3. Reset button

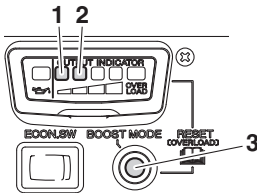

After one-second absence, the light "A" flashes every 1000 hours, and the light "B" flashes every 100 hours.

For example, if the light "A" flashes 2 times and the light "B" flashes 3 times, it shows that the total operation time is about 2300 hours.

TIP

Hour meter does not function when the generators are in parallel operation (Twin Tech).

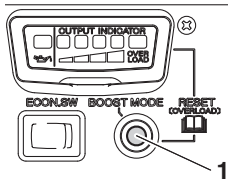

Boost mode switch

The boost mode switch raises up the number of rotation of the engine temporarily (for approximately 60 seconds). When using devices that require a large starting current, such as a compressor of a submersible pump or refrigerator, use this switch.

To enter the boost mode, push the boost mode switch for 3 seconds. To exit the boost mode, push the boost mode switch for 3 seconds again.

1. Boost mode switch

TIP

After approximately 60 seconds of the boost mode, the generator will return to the normal mode automatically.

Twin Tech (parallel running terminal)

The Twin Tech terminals are used for connecting two identical generators (EF2200iS) in parallel by using the dedicated cable.

It cannot be connected to any other generator than the EF2200iS.

When operating these two generators with identical specifications in parallel, 3.6 kVA and 15.6 A (for Europe), or 3.4 kVA and 15.0 A (for Australia) will be output.

1. Twin Tech (parallel running terminal)

- A For Europe
- B For Australia

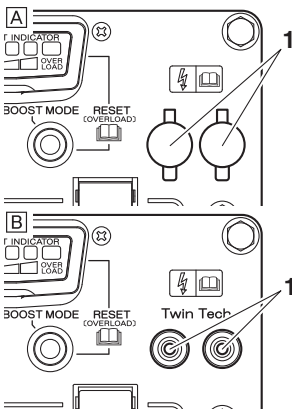

TIP

For parallel operation, a separately-sold parallel cord set is required. Before use, be sure to carefully read the parallel cord set owner's manual, which is included with the parallel cord set.

Accessory socket

This generator has an accessory socket with a cover. It is suitable for the use with portable electric devices.

1. Accessory socket

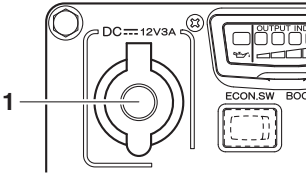

AC receptacle

This generator has two AC receptacles.

Before connection, confirm the shapes of the consents and the specifications of both the generator and the devices to be connected.

1. AC receptacle

A For Europe

B For Australia

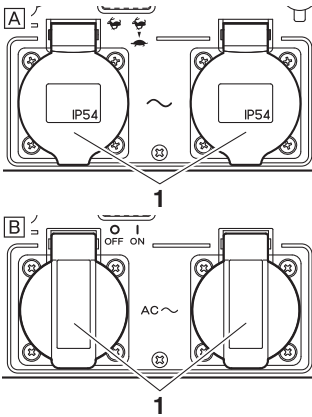

Carburetor fuel drain cock

Carburetor fuel drain cock is used to discharge the remained fuel in the carburetor for long term storage.

Before operation, make sure that the carburetor fuel drain cock is in "CLOSED".

1. Carburetor fuel drain cock
2. "CLOSED"
3. "OPEN"

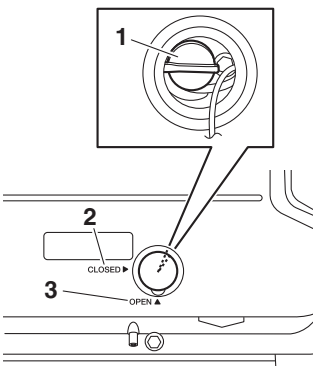

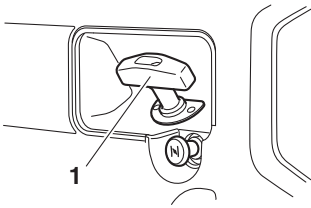

Recoil starter

The recoil starter is used to start the engine. Pull the recoil starter handle slowly until it is engaged, then pull it briskly.

1. Recoil starter handle

NOTICE

- Pull the recoil starter handle straight unless it breaks by getting caught in a part around it.
- Return the recoil starter handle slowly, not to break the parts of the generator due to the impact when the recoil starter handle retracts vigorously by letting go of the hand while pulling the recoil starter handle.
- Do not touch the recoil starter handle while the generator is operating.

Before operation

Preparation

Fuel

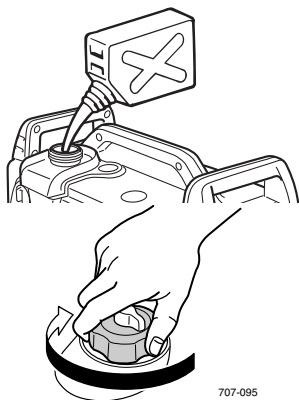

! WARNING

- Fuel is highly flammable and poisonous. Check “Safety information” (See page 1-1) carefully before filling.
- Do not overfill the fuel tank over the red level of the fuel tank strainer, otherwise it may overflow when the fuel warms up and expands.
- Never refuel while smoking or in the vicinity of an open flame.
- Refuel after discharging static electricity from the body, in order not to get burnt by letting a spark catch on fire.
- After fill the fuel, make sure the fuel tank cap is tightened securely.

1. Stop the engine. (See page 4-3)
2. Place the generator on a level surface.
3. Remove the fuel tank cap.
4. Check the fuel level.
5. If low, fill the tank with fuel.

NOTICE

- Immediately wipe off spilled fuel with a clean, dry, soft cloth, since fuel may deteriorate painted surfaces or plastic parts.
- Use only unleaded gasoline. The use of leaded gasoline will cause severe damage to internal engine parts.
If foreign materials enter the fuel tank, they may clog the fuel line. Thus, fill the fuel with the fuel tank strainer certainly installed.

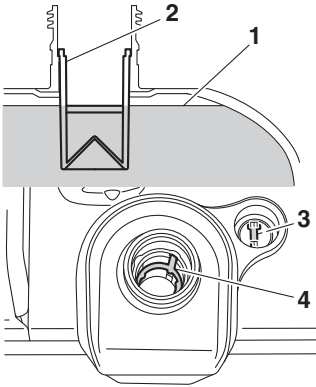

Make sure there is sufficient fuel in the tank. When refueling, be sure to fill the tank up to the "LEVEL" mark of the fuel tank strainer.

1. Fuel level
2. Fuel tank strainer
3. Fuel level gauge
4. "LEVEL" (Red)
5. "F" (Full)
6. "E" (Empty)

Recommended fuel:

Unleaded gasoline (Gasohol [E10] acceptable)

Fuel tank capacity:

Total:

4.7 L (1.24 US gal, 1.03 Imp gal)

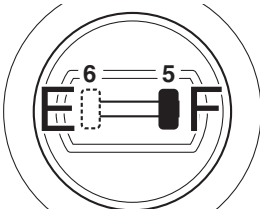

Your Yamaha engine has been designed to use regular unleaded gasoline with a pump octane number $((R + M)/2)$ of 86 or higher, or research octane number of 91 or higher.

TIP

For European customers:

- This mark identifies the recommended fuel for this machine as specified by European regulation (EN228).
- Check that gasoline nozzle has the same identifier when fueling.

Engine oil

NOTICE

The generator was shipped from the factory without engine oil. Do not start the engine for the first time until the oil level has been checked and oil added if necessary.

1. Place the generator on a level surface.

Before operation

A

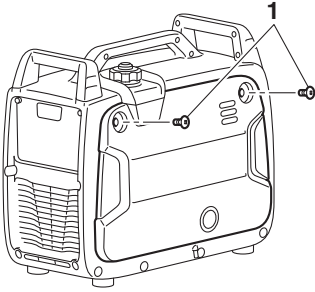

2. Remove the screws (for Europe). Or turn the panel openers to disengage the lock (for Australia).

1. Screw
2. Panel opener

A For Europe

B For Australia

B

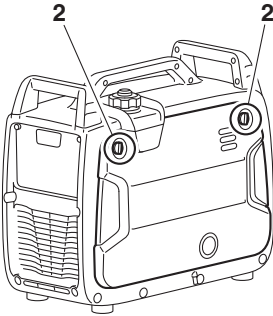

3. Remove the panel by detaching the hooks.

1. Hook
2. Panel

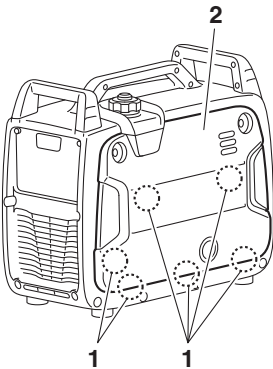

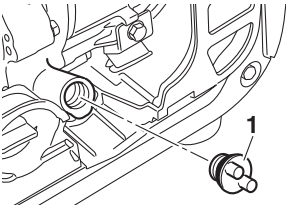

4. Remove the oil filler cap.
 1. Oil filler cap

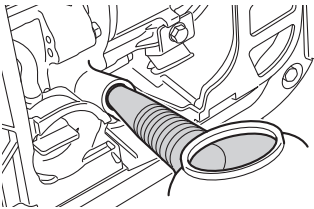

5. Fill the specified amount of the recommended engine oil, and then install and tighten the oil filler cap.

NOTICE

- Do not tilt the generator when adding engine oil. This could result in overfilling and damage to the engine.
- Be sure no foreign material enters the crankcase.

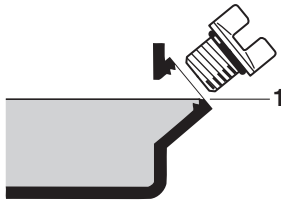

1. Correct level

Recommended engine oil:

Recommended oil brand:

YAMALUBE

Available oil grade:

API SE type or higher JASO MA or MB

Available viscosity index:

10W-30 or 10W-40

Engine oil quantity:

0.4 L (0.42 US qt, 0.35 Imp qt)

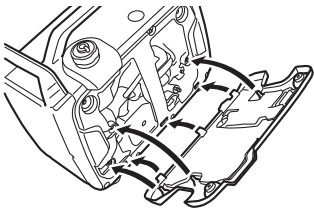

6. Install the panel.

7. Finger-tighten the panel openers to engage the lock (for Australia). Or install the screws (for Europe).

Panel screw tightening torque:

1.5 N·m (0.15 kgf·m, 1.1 lb-ft)

Pre-operation check

WARNING

If any item in the pre-operation check is not working properly, have it inspected and repaired before operating the generator.

The condition of a generator is the owner's responsibility. Vital components can start to deteriorate quickly and unexpectedly, even if the generator is unused.

TIP

Pre-operation checks should be made each time the generator is used.

- **Carburetor fuel drain cock**
 - Make sure that the cock is closed.
- **Fuel (See page 3-1)**
 - Check fuel level in fuel tank.
 - Refuel if necessary.
- **Fuel line**
 - Make sure that the fuel should not leak from the generator when turning on the engine switch.
 - Consult a Yamaha dealer, if necessary.
- **Engine oil (See page 3-2)**
 - Check oil level in engine.
 - If necessary, add recommended oil to specified level.
 - Check generator for oil leakage.
- **The point where abnormality was recognized by use**
 - If any abnormal running conditions are observed, please consult a Yamaha dealer.

Operation

Precautions for use

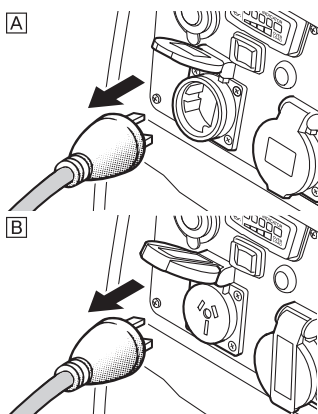

⚠ WARNING

- Never operate the engine in a closed area or it may cause unconsciousness and death within a short time. Operate the engine in a well ventilated area.
- Before starting the engine, do not connect any electric devices.
- Clean dusts, dirt or water off the receptacle before use.

A For Europe

B For Australia

NOTICE

The generator was shipped from the factory without engine oil. Do not start the engine for the first time until the oil level has been checked and oil added if necessary.

TIP

Soon after the purchase or after draining the fuel from the carburetor with the carburetor fuel drain cock, the fuel will not be supplied to the entire starting system automatically. Thus, the recoil starter handle may have to be pulled a few times until the engine starts.

Starting the engine

1. While holding the fuel tank cap so that it will not move, turn the air vent lever to "ON".

1. "ON"

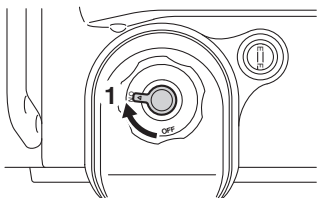

Operation

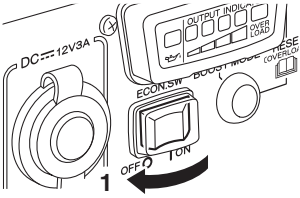

2. Turn the economy control switch to “○”/“⬅” (OFF), if necessary.

1. “○”/“⬅” (OFF)

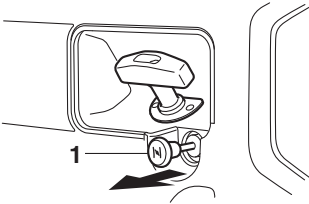

3. Pull the choke knob fully out.

1. Choke knob

TIP

The choke is not required to start a warm engine. Push the choke knob in to the original position.

4. Turn the engine switch to “I” (RUN).

1. “I” (RUN)

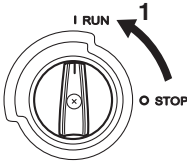

5. Pull the recoil starter handle slowly until it is engaged, then pull it briskly.

⚠ WARNING

Be careful when using recoil starter. In rare cases, the recoil starter handle can be drawn back quickly by the engine kickback.

NOTICE

- Pull the recoil starter handle straight unless it breaks by getting caught in a part around it.
- Return the recoil starter handle slowly, not to break the parts of the generator due to the impact when the recoil starter handle retracts vigorously by letting go of the hand while pulling the recoil starter handle.
- Grasp the carrying handle firmly to prevent the generator from falling over when pulling the recoil starter.

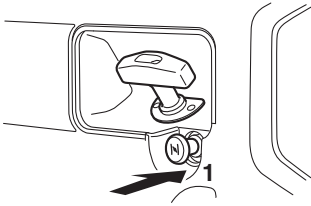

6. After the engine starts, warm up the engine until the engine does not stop when the choke knob is returned to the original position.

1. Original position

TIP

When starting the engine, with the economy control switch “I”/“ ” (ON), and there is no load on the generator:

- in ambient temperature below 0 °C (32 °F), the engine will run at the rated r/min (4900 r/min) for 5 minutes to warm up the engine.
- in ambient temperature below 5 °C (41 °F), the engine will run at the 4900 r/min for 3 minutes to warm up the engine.

The economy control unit operates normally after the above time period, while the economy control switch is “I”/“ ” (ON).

Stopping the engine

1. Turn off any electric devices.
2. Turn the economy control switch to “○”/“ ” (OFF), if necessary.

1. “○”/“ ” (OFF)

3. Disconnect any electric devices.

- A** For Europe
- B** For Australia

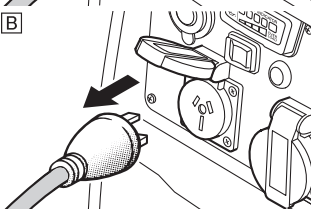
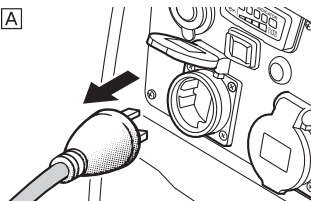
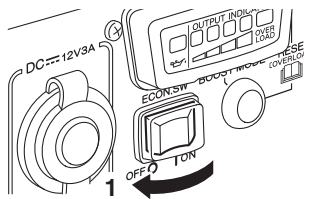

Operation

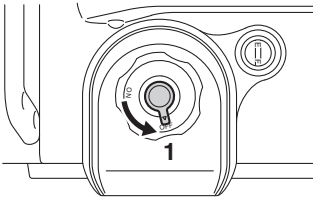
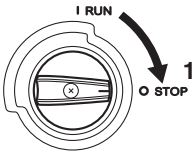

4. Turn the engine switch to “O” (STOP).

1. “O” (STOP)

5. Turn the fuel tank cap air vent lever to “OFF” after the engine has completely cooled down.

1. “OFF”

Connecting devices via Alternating Current (AC) receptacles

WARNING

Be sure any electric devices are turned off before plugging them in.

NOTICE

- Be sure all electric devices including the lines and plug connections are in good condition before connection to the generator.
 - Be sure the total load is within generator rated output.
 - Be sure the receptacle load current is within receptacle rated current.
-

TIP

Make sure to ground (earth) the generator. When the electric device is grounded, be sure to ground the generator, too.

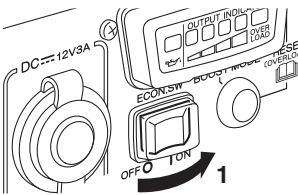
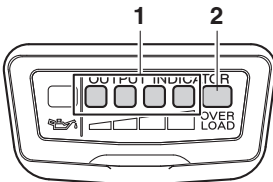
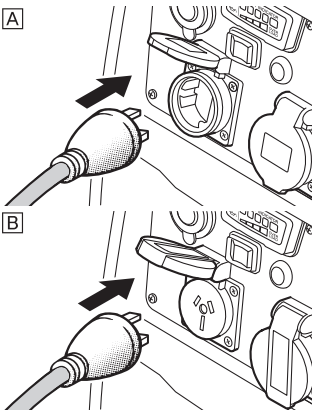

1. Start the engine (See page 4-1).
2. Plug in to AC receptacle.

- A For Europe
- B For Australia

3. Make sure that all the output indicators and the overload indicator light come on.

1. Output indicator (Green)
2. Overload indicator light (Red)

4. Make sure that the output indicators and the overload indicator light once turn off, and then the only one of the output indicators still remains on.

5. Turn the economy control switch to "I"/"ON", if necessary.

1. "I"/"ON" (ON)

6. Turn on any electric devices.

TIP

The economy control switch must be turned to "O"/"OFF" (OFF) to increase engine speed to rated r/min.

Connecting devices via the accessory socket

⚠ WARNING

Be sure any electric devices are turned off before plugging them in.

NOTICE

- Be sure all electric devices including the lines and plug connections are in good condition before connection to the generator.
 - Be sure the total load is within generator rated output.
 - Be sure the receptacle load current is within receptacle rated current.
-

TIP



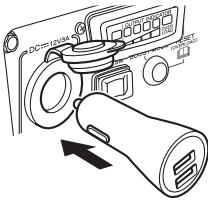

- Make sure to ground (earth) the generator. When the electric device is grounded, be sure to ground the generator, too.
 - This accessory socket is for charging personal devices such as cell phones, GPS units, tablets, etc.
-



1. Start the engine (See page 4-1).
2. Open the cover, and then plug in to the accessory socket.
3. Turn on the electric device.

Application range

When using the generator, make sure the total load is within rated output of a generator. Otherwise, generator damage may occur.

	AC			DC (Accessory socket)
				
Power factor	1	0.8–0.95	0.4–0.75 (Efficiency 0.85)	Rated voltage 12 V Rated current 3 A
	–1800 W	–1440 W	–612 W	

TIP

- “–” means below.
- Application wattage indicates when each device is used by itself.
- The simultaneous usage of AC and DC power is possible but total wattage should not exceed the rated output.

EX:

Generator rated output		1800 VA
Frequency	Power factor	
AC	1.0	–1764 W
	0.8	–1404 W
DC	—	36 W (12 V/3 A)

- The overload indicator light comes on when electricity over the rated output is required by the connected electrical devices, or when the inverter control unit overheats.

NOTICE

- **Do not overload. The total load of all electrical appliances must not exceed the total supply range of both AC and DC of the generator. Overloading will damage the generator.**
 - **When supplying precision equipment, electronic controllers, PCs, electronic computers, microcomputer-based equipment or battery chargers, keep the generator a sufficient distance away to prevent electrical interference from the engine. Also ensure that electrical noise from the engine does not interfere with any other electrical devices located near the generator.**
 - **If the generator is to supply medical equipment, advice should first be obtained from the manufacturer, a medical professional or hospital.**
 - **Some electrical appliances or general-purpose electric motors have high starting currents, and cannot therefore be used, even if they lie within the supply ranges given in the above table even though you use the boost mode switch. Consult the equipment manufacturer for further advice.**
-

High altitude operation

This engine may require a high altitude carburetor kit to ensure correct engine operation at altitudes above 4000 ft. (1219 meters). If you operate your engine at altitudes above 4000 ft. (1219 meters) consistently, have your local Yamaha dealer perform the necessary carburetor modification. This engine should be operated in its original configuration below 4000 ft. (1219 meters) as damage may occur if high altitude carburetor kit is installed and operated below 4000 ft. (1219 meters).

Periodic maintenance

The importance of maintenance

Safety is an obligation of the owner. Periodic inspection, adjustment and lubrication will keep your generator in the safest and most efficient condition possible. The most important points of generator inspection, adjustment, and lubrication are explained on the following pages.

WARNING

If you are not familiar with maintenance work, have a Yamaha dealer do it for you.

Check before use

The customer needs to perform the pre-operation check (See page 3-5). If any problems are discovered during the inspection, contact a Yamaha dealer and request an inspection or maintenance.

Maintenance chart

WARNING

Stop the engine before starting maintenance work.

NOTICE

Use only Yamaha specified genuine parts for replacement. Ask an authorized Yamaha dealer for further information.

Item	Routine	Pre-operation check	Every		
			6 months or 100 Hrs	12 months	300 Hrs
Engine oil	• Check oil level in engine.	√			
	• Replace.		√ (*1)		
Fuel	• Check fuel level and leakage.	√			
Fuel hose	• Visual inspection.	★			
	• Check for cracks or damage with fingers.			★	
Spark plug	• Clean and replace if necessary.				√
Air filter	• Check for cracks or damage. Clean.		√ (*2)		
Muffler screen	• Check condition.		√		

Periodic maintenance

Item	Routine	Pre-operation check	Every		
			6 months or 100 Hrs	12 months	300 Hrs
Fuel tank strainer	• Check for dirt and clogging. Clean if necessary.	√			
	• Check for cracks.			√	
Fuel cock strainer	• Remove the cock, check for clogging, and clean if necessary.			★	
Breather hose	• Check for poor connection.			★	
Cylinder head	• Decarbonize cylinder head.				★
Intake/Exhaust valves	• Check and adjust valve clearance.				★
Recoil starter	• Check for fine splits and damage.	√			
Outer covers	• Check outer covers for installation and damage.	√			
Fittings/fasteners	• Check that bolts are securely fastened. Fasten them if necessary.		√		
Output voltage	• Check that output indicators are on.	√			
Visual inspection for potential damage		√			

*1..... Initial replacement of the engine oil is after one month or 20 hours of operation.

*2..... Needs to be cleaned more frequently when using in unusually wet or dusty areas.

★ Since these items require special tools, data and technical skills, have a Yamaha dealer perform the service.

Engine oil replacement

WARNING

Avoid draining the engine oil immediately after stopping the engine. The oil is hot and should be handled with care to avoid burns.

- 1.** Place the generator on a level surface and warm up the engine for several minutes. Then stop the engine, then turn the engine switch to “○” (STOP) and fuel tank cap air vent lever to “OFF”.
- 2.** Remove the screws (for Europe). Or turn the panel openers to disengage the lock (for Australia).

1. Screw
2. Panel opener

 For Europe

 For Australia



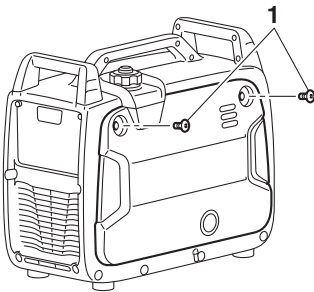



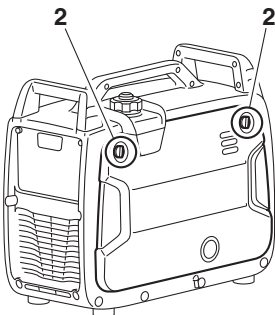

Periodic maintenance

3. Remove the panel by detaching the hooks.

1. Hook
2. Panel

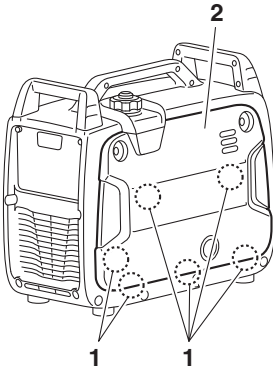

4. Remove the oil filler cap.

1. Oil filler cap
2. O-ring

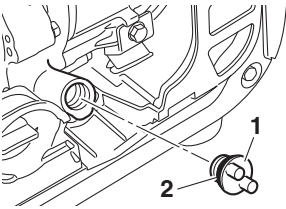

5. Place an oil pan under the engine. Tilt the generator to drain the oil completely.

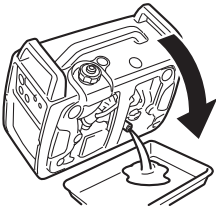

6. Check the oil filler cap and O-ring. Replace them if damaged.

7. Place the generator on a level surface.

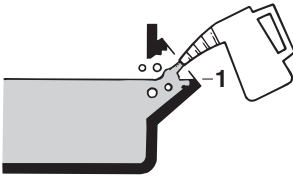
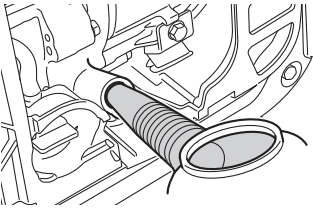

8. Add engine oil to the correct level.

NOTICE

- **Do not tilt the generator when adding engine oil. This could result in overfilling and damage to the engine.**
- **Be sure no foreign material enters the crankcase.**

1. Correct level

Recommended engine oil:

Recommended oil brand:

YAMALUBE

Available oil grade:

API SE type or higher JASO MA or MB

Available viscosity index:

10W-30 or 10W-40

Engine oil quantity:

0.4 L (0.42 US qt, 0.35 Imp qt)

9. Wipe the panel clean, and wipe up any spilled oil.

10. Install the O-ring and the oil filler cap.

11. Install the panel.

12. Finger-tighten the panel openers to engage the lock (for Australia). Or install the screws (for Europe).

Panel screw tightening torque:

1.5 N·m (0.15 kgf·m, 1.1 lb·ft)

Spark plug inspection

The spark plug is an important engine component, which should be checked periodically.

! WARNING

Soon after stopping the engine, do not touch the spark plug and the engine. As they are hot, it may result in a burn.

Periodic maintenance

TIP

The spark plug tool is not included with the generator. Please obtain the appropriate 20.8 mm (13/16 in) spark plug wrench.

A

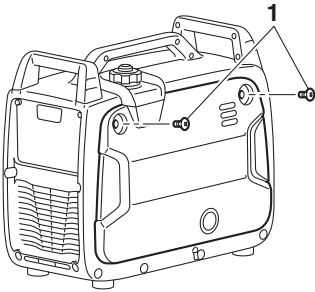

1. Remove the screws (for Europe). Or turn the panel openers to disengage the lock (for Australia).

1. Screw
2. Panel opener

A For Europe

B For Australia

B

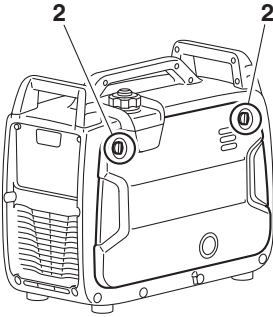

2. Remove the panel by detaching the hooks.

1. Hook
2. Panel

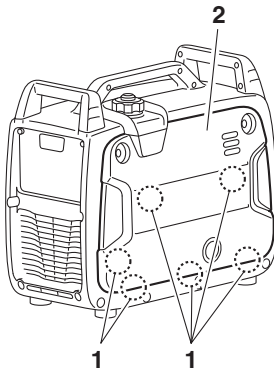

3. Remove the spark plug cap and access cap, and insert the tool through the hole from the outside of the cover.

1. Spark plug cap
2. Access cap

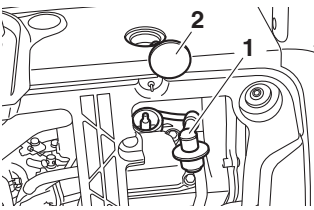

4. Insert the handlebar into the tool and turn it counterclockwise to remove the spark plug.

1. Tool
2. Handlebar

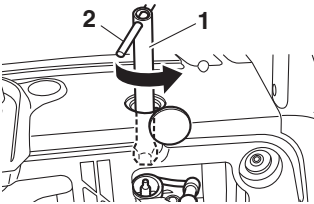

5. Check for discoloration and remove the carbon. The porcelain insulator around the center electrode of spark plug should be a medium-to-light tan color.

6. Check the spark plug type and gap.

1. Spark plug gap

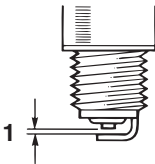

Standard spark plug:

BPR6HS (NGK)

Spark plug gap:

0.6–0.7 mm (0.024–0.028 in)

TIP _____

The spark plug gap should be measured with a wire thickness gauge and, if necessary, adjusted to specification.

- 7.** Install the spark plug.

Spark plug tightening torque:
20 N·m (2.0 kgf·m, 15 lb·ft)

TIP _____

If a torque wrench is not available when installing a spark plug, a good estimate of the correct torque is 1/4–1/2 turn past finger tight. However, the spark plug should be tightened to the specified torque as soon as possible.

- 8.** Install the spark plug cap and access cap.
9. Install the panel.
10. Finger-tighten the panel openers to engage the lock (for Australia). Or install the screws (for Europe).

Panel screw tightening torque:
1.5 N·m (0.15 kgf·m, 1.1 lb·ft)

Air filter cleaning

A

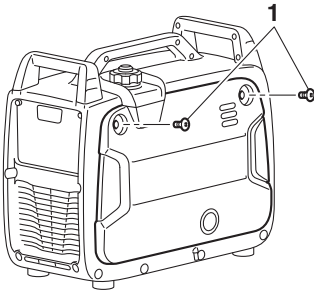

1. Remove the screws (for Europe). Or turn the panel openers to disengage the lock (for Australia).

1. Screw
2. Panel opener

A For Europe

B For Australia

B

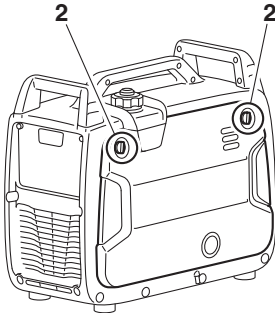

Periodic maintenance

2. Remove the panel by detaching the hooks.

1. Hook
2. Panel

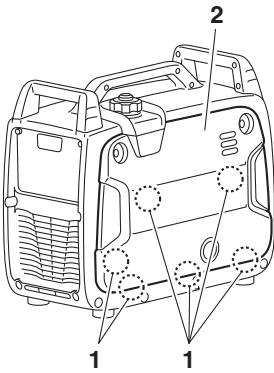

3. Remove the screw and then remove the air filter case cover.

1. Screw
2. Air filter case cover

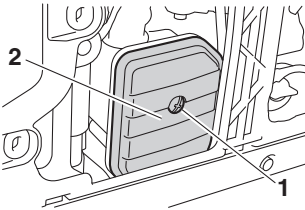

4. Remove the foam element.

1. Screw
2. Air filter case cover
3. Foam element

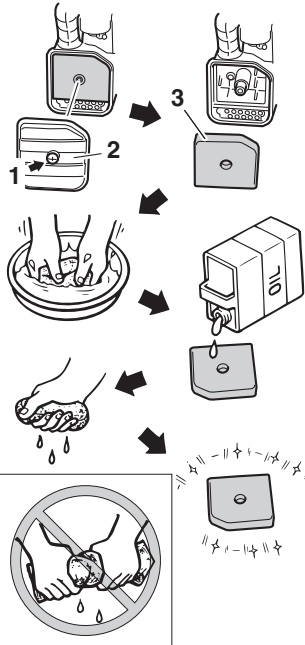

5. Wash the foam element with a foam air filter cleaner and dry it.
6. Oil the foam element and squeeze out excess oil. The foam element should be wet but not dripping.

NOTICE

Do not wring out the foam element when squeezing it.

This could cause it to tear.

Recommended oil:

Foam air filter oil or equivalent oil

7. Insert the foam element into the air filter case.

NOTICE

The engine should never run without the foam element; excessive piston and cylinder wear may result.

TIP

Be sure the foam element sealing surface matches the air filter so there is no air leak.

8. Install the air filter case cover in its original position and tighten the screw.
9. Install the panel.
10. Finger-tighten the panel openers to engage the lock (for Australia). Or install the screws (for Europe).

Panel screw tightening torque:

1.5 N·m (0.15 kgf·m, 1.1 lb-ft)

Muffler screen and spark arrester cleaning

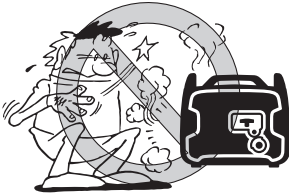

WARNING

The engine and muffler will be very hot after the engine has been run.

Avoid touching the engine and muffler while they are still hot with any part of your body or clothing during inspection or repair.

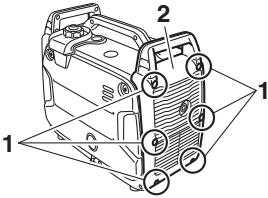

1. Remove the muffler cover bolts, and then remove the muffler cover.

1. Muffler cover bolt
2. Muffler cover

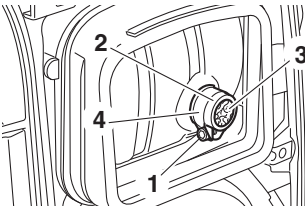

2. Loosen the muffler cap bolt and then remove the muffler cap, muffler cap band and muffler screen.

1. Muffler cap bolt
2. Muffler cap
3. Muffler screen
4. Muffler cap band

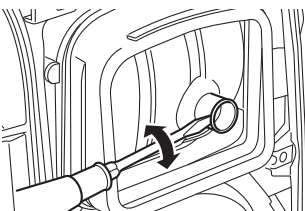

3. Use a flathead screw driver to pry the spark arrester out from the muffler.

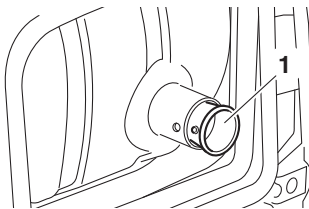

4. Remove the spark arrester.

1. Spark arrester

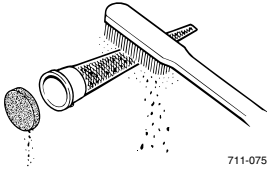

5. Remove the carbon deposits on the muffler cap, muffler screen and spark arrester using a wire brush.

NOTICE

When cleaning, use the wire brush lightly to avoid damaging or scratching of the muffler cap, muffler screen and spark arrester.

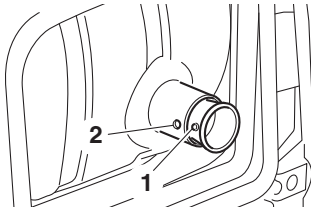

6. Check the muffler screen and spark arrester. Replace them if damaged.
7. Install the spark arrester.

TIP

Align the spark arrester projection to the hole in the muffler pipe.

1. Spark arrester projection
2. Hole

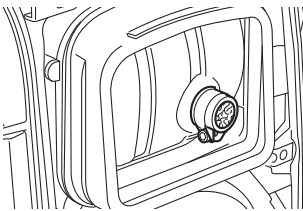

8. Install the muffler screen, muffler cap and muffler cap band, and then tighten the muffler cap bolt.

Muffler cap bolt tightening torque:

3.5 N·m (0.35 kgf·m, 2.6 lb·ft)

9. Install the muffler cover and tighten the muffler cover bolts.

Muffler cover bolt tightening torque:

7 N·m (0.7 kgf·m, 5.2 lb·ft)

Fuel tank strainer cleaning

! WARNING

Never use gasoline while smoking or in the vicinity of an open flame.

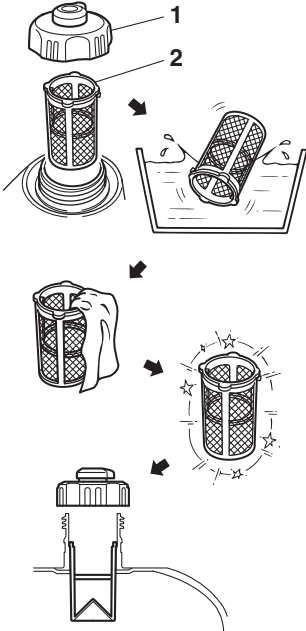

1. Remove the fuel tank cap and fuel tank strainer.

1. Fuel tank cap
2. Fuel tank strainer

2. Clean the fuel tank strainer with gasoline. Replace it if damaged.

3. Wipe the fuel tank strainer and insert it.

4. Install the fuel tank cap.

! WARNING

Be sure the fuel tank cap is tightened securely.

Carburetor adjustment

The carburetor is a vital part of the engine. Adjusting should be left to a Yamaha dealer with the professional knowledge, specialized data, and equipment to do so properly.

Storage

Long term storage of your machine will require some preventive procedures to guard against deterioration.

Drain the fuel

1. Turn the engine switch to “○” (STOP).

1. “○” (STOP)

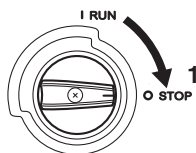

2. Remove the fuel tank cap and fuel tank strainer. Extract the fuel from the fuel tank into an approved gasoline container using a commercially available hand siphon. Then, install the fuel tank strainer and fuel tank cap.

WARNING

- Fuel is highly flammable and poisonous. Check “Safety information” (See page 1-1) carefully.
- Install the fuel tank cap securely.
- Immediately wipe off spilled fuel with a rag. Fire hazard may occur.

NOTICE

Immediately wipe off spilled fuel with a clean, dry, soft cloth, since fuel may deteriorate painted surfaces or plastic parts.

Storage

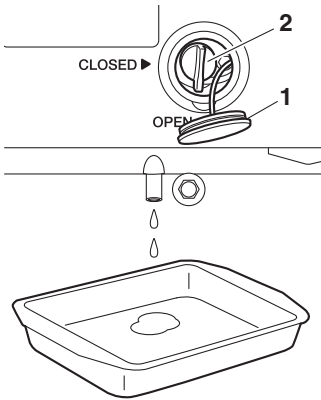

3. Drain the fuel from the carburetor by turning the carburetor fuel drain cock to “OPEN”.

1. Cap
2. Carburetor fuel drain cock

! WARNING

Immediately wipe off spilled fuel with a rag. Fire hazard may occur.

NOTICE

Do not turn the carburetor fuel drain cock with any tools not to break the cock.

TIP

When draining the fuel from the carburetor, place the generator on a level surface.

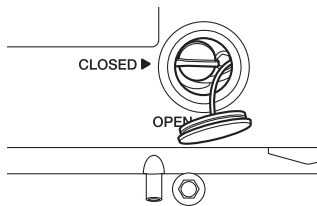

4. After draining the fuel, turn the carburetor fuel drain cock to “CLOSED”.

5. Slowly pull the recoil starter until compression or resistance is felt, at this point you can slowly allow the recoil starter to return.
6. Turn the fuel tank cap air vent lever to “OFF” after the engine has completely cooled down.
7. Inspect unit for any loose fasteners or damaged components prior to storage.
8. Store the generator in a dry, well-ventilated place, with the cover placed over it.

Engine

Perform the following steps to protect the cylinder, piston ring, etc. from corrosion.

- 1.** Remove the spark plug, pour about one tablespoon of engine oil (See page 5-3) into the spark plug hole and install and tighten the spark plug to the specified torque. Recoil start the engine by turning over several times (with ignition off) to coat the cylinder walls with oil.
- 2.** Pull the recoil starter until you feel compression. Then stop pulling. (This prevents the cylinder and valves from rusting).
- 3.** Clean exterior of the generator and apply a rust inhibitor.
- 4.** Store the generator in a dry, well-ventilated place, with the cover placed over it.
- 5.** The generator must remain in a vertical position when stored, carried or operated.



Trouble recovery

Troubleshooting

This section describes the likely causes and remedies for problems. If your Generator requires repair, bring it to a Yamaha dealer.

Engine won't start

Item	Check	Action	Page
Fuel	Is there fuel in the fuel tank?	Supply fuel.	3-1
	Is the engine switch in "I" (RUN)?	Turn the engine switch to the "I" (RUN).	2-5
	Is the fuel tank cap air vent lever closed?	Turn the fuel tank cap air vent lever to the "ON".	2-7
	Have you drained the fuel according to the procedure of storage after the previous use?	The fuel line and the carburetor may be clogged. Consult a Yamaha dealer.	—
Engine oil	Is the engine oil level low?	Add engine oil.	3-2
Spark plug	Is the spark plug dirty with carbon or wet?	Remove carbon or wipe spark plug dry.	5-5

7 The machine suddenly stopped

Item	Check	Action	Page
Receptacle(s)	Are the device(s) correctly plugged in to the receptacle(s)?	Plug in the device(s) correctly.	4-4, 4-6
Output indicator(s)	Are the output indicator(s) turned off?	Make sure that the engine is running correctly.	4-1
Overload indicator light	Does the overload indicator light come on?	Make sure that the total wattage of connected device(s) is within the rated range.	2-7
	Is the overload indicator light flashing?	Some malfunctions have been detected. Consult a Yamaha dealer.	—

Output indicator(s) do not come on

Item	Check	Action	Page
Overload indicator light	Does the overload indicator light come on?	Make sure that the total wattage of connected device(s) is within the rated range.	2-7
	Is the overload indicator light flashing?	Some malfunctions have been detected. Consult a Yamaha dealer.	—
	The reset button does not function even while the overload indicator light is coming on.	Consult a Yamaha dealer.	—

Overload indicator light does not turn off

Item	Check	Action	Page
Receptacle(s)	Are the device(s) plugged out from the receptacle(s)?	Plug out any connected devices from the receptacle(s).	—

The device(s) that had been working correctly before do not work

Item	Check	Action	Page
Device(s)	Are you using an extension cord?	Connect the device(s) directly without using extension cords.	—
	Do the device(s) stop due to a voltage drop?	It is not recommended to use devices that are sensitive to voltage fluctuation. Also make sure that the total wattage of connected device(s) is within the rated range.	4-7

Multi-function LED meter flash or come on abnormally

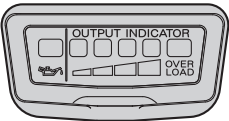
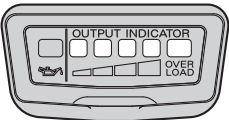
Display	Check	Action	Page
	Are some of the output indicator(s) and overload indicator light off even when the engine is started?	Consult a Yamaha dealer.	—
	Do the output indicator(s) and the overload indicator light come on for a few seconds immediately after starting the engine?	It is not a malfunction. The multi-function LED meter is in self-diagnostic mode.	—

Trouble recovery

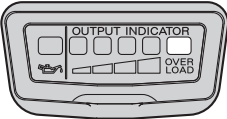
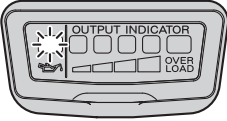
Display	Check	Action	Page
 <p>The image shows a generator control panel with a digital display. The display is divided into two main sections: 'OUTPUT INDICATOR' on the left and 'OVER LOAD' on the right. The 'OVER LOAD' section contains a single indicator light that is illuminated. The 'OUTPUT INDICATOR' section contains four indicator lights, all of which are unlit.</p>	<p>After all the output indicator(s) come on, the overload indicator light comes on, then only output indicators turn off after a few seconds or a few minutes.</p>	<p>The engine is overload. Disconnect any devices from the generator, reduce the total wattage within the rated range, and push the reset button for 3 seconds while the overload indicator light is coming on.</p>	<p>2-7</p>
 <p>The image shows a generator control panel with a digital display. The display is divided into two main sections: 'OUTPUT INDICATOR' on the left and 'OVER LOAD' on the right. The 'OUTPUT INDICATOR' section contains four indicator lights, all of which are unlit. The 'OVER LOAD' section contains a single indicator light that is flashing. The 'OVER LOAD' section also contains a small icon of a sun with rays, which is the oil level warning light.</p>	<p>Is the oil level warning light flashing?</p>	<p>Add sufficient engine oil. Place the generator on a level surface.</p>	<p>3-2</p>

For any other abnormal operating conditions not covered here, please consult a Yamaha dealer.

Specifications

EF2200iS

DIMENSIONS:	
Overall length	555 mm (21.9 in)
Overall width	300 mm (11.8 in)
Overall height	470 mm (18.5 in)
Dry weight	25 kg (55 lb)
ENGINE:	
Engine type	Air cooled 4-stroke gasoline OHV
Cylinder arrangement	Inclined, 1 cylinder
Displacement	79 cm ³
Bore × Stroke	48.6 × 43.0 mm (1.91 × 1.69 in)
Operations run time	4.2 hrs at rated load or 10.5 hrs at 1/4 of rated load
Fuel type	Unleaded gasoline (Gasohol [E10] acceptable)
Fuel tank capacity	4.7 L (1.24 US gal, 1.03 Imp gal)
Engine oil quantity	0.4 L (0.42 US qt, 0.35 Imp qt)
Ignition system	CDI
Spark plug	BPR6HS (NGK)
Spark plug gap	0.6–0.7 mm (0.024–0.028 in)
Guaranteed sound power level*	91 dB(A)
Acoustic pressure level at 1 m* (2006/42/EC)	76 dB(A)
Uncertainty	2 dB(A)
GENERATOR:	
AC output	
Rated voltage	230 V
Rated frequency	50 Hz
Rated current	7.8 A
Rated output	1.8 kVA
Rated current (in parallel)	15.6 A (for Europe), 15.0 A (for Australia)
Rated output (in parallel)	3.6 kVA (for Europe), 3.4 kVA (for Australia)
Safety device	Electronic
DC output	
Rated voltage	12 V
Rated current	3 A
Safety device	Electronic

* : Noise level is measured when the economy control switch is turned to "I"/"  " (ON).

LWg shows the sound power level under the ISO3744 satisfied test conditions.
The noise level may vary in different environments.

Specifications

Noise Level:

“The figures quoted are emission levels and are not necessarily safe working levels. Whilst there is a correlation between the emission and exposure levels, this cannot be used reliably to determine whether or not further precautions are required. Factors that influence the actual level of exposure of work-force include the characteristics of the work room, the other sources of noise, etc. i.e. the number of machines and other adjacent processes, and the length of time for which an operator is exposed to the noise. Also the permissible exposure level can vary from country. This information, however, will enable the user of the machine to make a better evaluation of the hazard and risk.”

Value of CO₂ emissions:

649.4 g/kWh, MZ80, EU type-approval certified

“This CO₂ measurement results from testing over a fixed test cycle under laboratory conditions a parent engine representative of the engine family and shall not imply or express any guarantee of the performance of a particular engine.”

Consumer information

Machine identification

The machine serial number is stamped in the location as shown.

1. Machine serial number

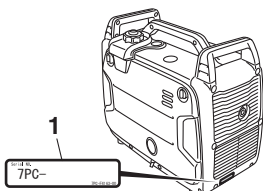

TIP

The first three digits of these numbers are for model identification (PRI-I.D. CODE); the remaining digits are the unit production number (SERIAL No). Keep a record of these numbers for reference when ordering parts from a Yamaha dealer.

Identification number records

Record your model type, Primary I.D., and serial numbers in the spaces provided, to assist you in ordering spare parts from a Yamaha dealer.

Also record and keep these I.D. numbers in a separate place in case your machine is stolen.

MODEL:

PRI-I.D. CODE:

SERIAL No:

Wiring diagram

For Europe

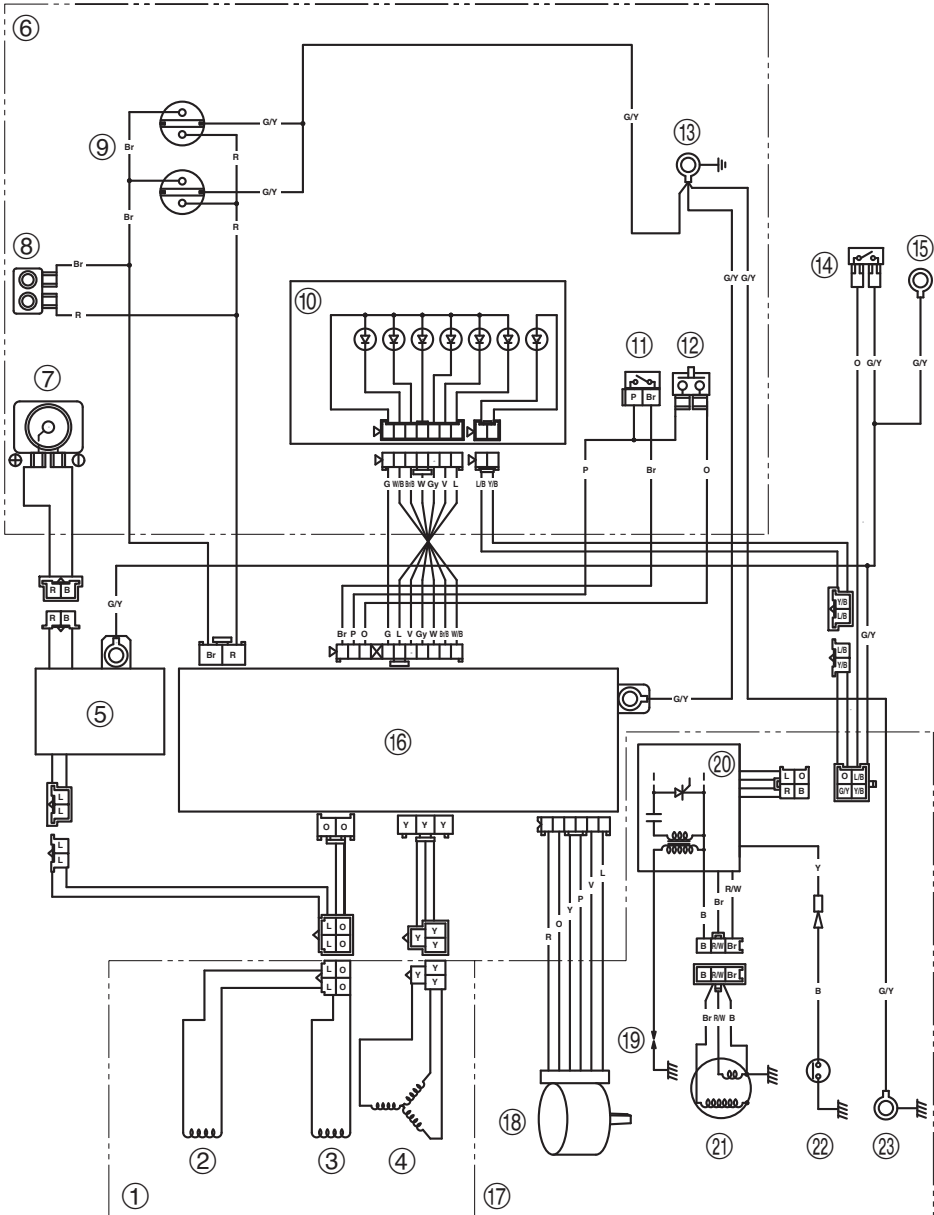

10

	Color code	
1. Generator		
2. DC coil		
3. AC sub coil	B	Black
4. AC coil	Br	Brown
5. AC/DC convertor	G	Green
6. Control box	Gy	Gray
7. Accessory socket	L	Blue
8. Twin Tech (parallel running terminal)	O	Orange
9. AC receptacle	P	Pink
10. Multi-function LED meter	R	Red
11. Economy control switch	V	Violet
12. Boost mode switch/Reset button	W	White
13. Ground (earth) terminal	Y	Yellow
14. Engine switch	Br/B	Brown/Black
15. Fuel cock ground (earth)	G/Y	Green/Yellow
16. Control unit	L/B	Blue/Black
17. Engine	R/W	Red/White
18. Throttle control motor	W/B	White/Black
19. Spark plug	Y/B	Yellow/Black
20. CDI unit/Ignition coil		
21. CDI magneto		
22. Oil level switch		
23. Ground (earth) terminal		

Wiring diagram

For Australia

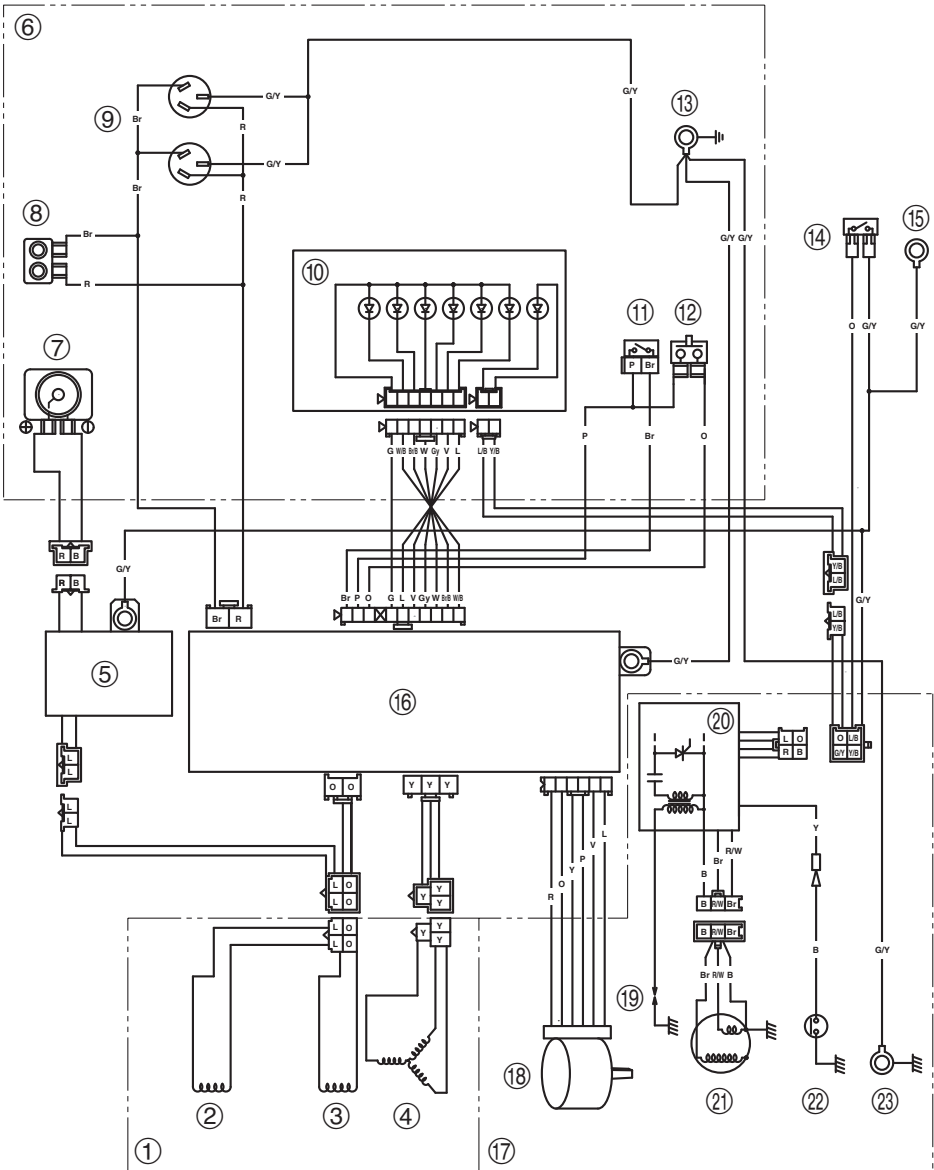

	Color code	
1. Generator		
2. DC coil		
3. AC sub coil	B	Black
4. AC coil	Br	Brown
5. AC/DC convertor	G	Green
6. Control box	Gy	Gray
7. Accessory socket	L	Blue
8. Twin Tech (parallel running terminal)	O	Orange
9. AC receptacle	P	Pink
10. Multi-function LED meter	R	Red
11. Economy control switch	V	Violet
12. Boost mode switch/Reset button	W	White
13. Ground (earth) terminal	Y	Yellow
14. Engine switch	Br/B	Brown/Black
15. Fuel cock ground (earth)	G/Y	Green/Yellow
16. Control unit	L/B	Blue/Black
17. Engine	R/W	Red/White
18. Throttle control motor	W/B	White/Black
19. Spark plug	Y/B	Yellow/Black
20. CDI unit/Ignition coil		
21. CDI magneto		
22. Oil level switch		
23. Ground (earth) terminal		

Index

- A**
 - Accessory socket 2-10
 - AC receptacle..... 2-10
 - Air filter cleaning..... 5-9
 - Application range 4-7
- B**
 - Boost mode switch 2-9
- C**
 - Carburetor adjustment 5-14
 - Carburetor fuel drain cock..... 2-10
 - Check before use 5-1
 - Connecting devices via Alternating Current (AC) receptacles 4-4
 - Connecting devices via the accessory socket..... 4-6
 - Connection 1-4
 - Connection notes 1-4
 - Control function 2-5
- D**
 - Description 2-1
 - Drain the fuel..... 6-1
- E**
 - Economy control switch 2-6
 - Electric shock prevention 1-3
 - Engine 6-3
 - Engine and muffler may be hot 1-3
 - Engine oil 3-2
 - Engine oil replacement..... 5-3
 - Engine switch 2-5
 - Exhaust fumes are poisonous..... 1-2
 - Extension cord notes..... 1-5
- F**
 - Fuel 3-1
 - Fuel is highly flammable and poisonous ... 1-2
 - Fuel level gauge..... 2-8
 - Fuel tank cap..... 2-5
 - Fuel tank cap air vent lever 2-7
 - Fuel tank strainer cleaning 5-14
- G**
 - General safety information 1-1
 - Ground (earth) terminal..... 2-6
- H**
 - High altitude operation 4-8
 - Hour meter 2-8
- I**
 - Identification number records..... 9-1
- L**
 - Location of important labels 1-6
- M**
 - Machine identification 9-1
 - Maintenance chart 5-1
 - Muffler screen and spark arrester cleaning..... 5-12
- O**
 - Oil level warning light (Red) 2-5
 - Overload indicator light (Red) 2-7
- P**
 - Power supply display 2-6
 - Precautions for use 4-1
 - Pre-operation check..... 3-5
 - Preparation 3-1
- R**
 - Recoil starter 2-11
 - Reset button..... 2-7
- S**
 - Spark plug inspection..... 5-5
 - Specifications, EF2200iS 8-1
 - Starting the engine 4-1
 - Stopping the engine 4-3
- T**
 - The importance of maintenance 5-1
 - Troubleshooting 7-1
 - Twin Tech (parallel running terminal)..... 2-9



Printed in China
2019.09×1 
(E)

Original instructions
Notice originale
Originalbetriebsanleitung
Istruzioni originali
Manual original
Instruções originais



Printed in China
2019.09×1 
(E, F, G, H, S, P)