

American Changer®



Coin/Token Changer Series Installation, Operation, and Service Manual



Changing the IndustrySM

! WARNING

Improper installation, adjustment, alteration, service, maintenance, or use of this machine can result in death, injury or property damage.

Installers & Service Technicians

Read and understand the instructions detailed in this manual.

Owners & Operators

Keep this manual in a safe place to provide to any service technicians working on this machine.

American Changer

1400 N.W. 65th Place, Ft. Lauderdale, FL 33309

Tel (954) 917-3009 • Fax (954) 917-3079

www.americanchanger.com www.hoffmanmint.com

List of Machines

Front Load:

- AC101
- AC201
- AC250
- AC250-CRR
- AC500
- AC1000
- AC1001
- AC1002
- AC2000
- AC2001
- AC2002
- AC2002.1
- AC2009
- AC8002

Rear Load:

- AC105
- AC205
- AC1005
- AC2005
- AC2221
- AC2225

Rowe:

- BC-1400A
- BC-2800A

Floor Models:

- AC1178
- AC2078-US
- AC6000

Table of Contents

Section 1 – Product Overview

1.1 – Machine Specifications.....	2
1.2 – Warranty Information.....	2
1.3 – Machine Safety.....	3

Section 2 – Setup & Installation

2.1 – Setup.....	5
2.2 – Mounting Instructions.....	6
2.3 – ADA Regulations.....	8

Section 3 – Operational Overview

3.1 – Component Description.....	9
3.2 – Functional Description.....	11
3.3 – Out-of-Service Conditions & Error Codes.....	11
3.4 – Programming Menu Universal Board.....	13
3.5 – Programming Menu Super Universal Board.....	22

Section 4 – Maintenance

4.1 – Coin Hopper Maintenance.....	31
4.2 – Bill Validator Maintenance.....	32
4.3 – Parts List.....	36
4.4 – Warranty Terms and Conditions.....	49

©2021 American Changer

All rights reserved. No part of this work covered by copyrights herein may be reproduced or copied in any form or by means – graphic, electronic or mechanical, including photocopying, recording, taping or information storage and retrieval systems – without the written permission of American Changer

Section 1 – Product Overview

1.1 – Machine Specifications

Operating Voltage (selectable by switch on power supply)	Set at 115VAC: 90 ~ 132VAC 4.0A Set at 230VAC: 180 ~ 264VAC 6.0A
Power Consumption	10 Watts
Operating Temperature	41°F to 104°F / 5°C to 40°C
Interface to Coin Hopper	24VDC, 2.5 amps max

***Note:** Specifications stated herein may vary without notice. Capacities are approximations and may vary.

1.2 – Warranty Information

PLEASE REFERENCE SECTION 4.4 ON PAGES 47 AND 48 FOR AMERICAN CHANGER’S DETAILED LIMITED WARRANTY AND EXCLUSIVE REMEDIES. SOME HIGHLIGHTS FROM SAID SECTION ARE:

Coin Hopper(s), Coin Acceptors and Logic Board

These items are warranted for one year from date of purchase.

Bill Validators

These are warranted for two years from the date of purchase.

COVERED

- Manufacturers’ defects in workmanship or materials

NOT COVERED

- Damage caused by shipping or physical abuse
- Misapplication
- Vandalism
- End users’ attempt, on their own, to repair components
- Cleaning and maintenance
- Power surges and lightning strikes

A Return Material Authorization number (RMA #) must be obtained from American Changer Corporation before returning a unit for repair; warranty or otherwise. A copy of invoices must accompany any and all warranty work.

Section 1.3 – Machine Safety

Your safety and the safety of others are very important to American Changer.

We have provided important safety messages in this manual and on your machine. Always read and obey all safety messages.



This is a safety alert symbol.

This symbol alerts you to potential hazards that can kill or hurt you and others. All safety messages will follow the safety alert symbol and either “DANGER”, “WARNING”, or “CAUTION”.

These words mean:



You can be killed or seriously injured if you don't immediately follow instructions



You can be killed or seriously injured if you don't follow instructions



You can be injured if you don't follow instructions

All safety messages will tell you what the potential hazard is, tell you how reduce the risk of injury, and tell you what can happen if the instructions are not followed.

Distributors, retailers, operators, and/or service people are to insure the following warning label is properly affixed on the ACC products to which you/they are using and/or servicing in order to help meet the applicable Proposition 65 requirements. For more information go to www.P65Warnings.ca.gov



WARNING: Cancer and Reproductive Harm

www.P65Warnings.ca.gov

Important Safety Instructions

DANGER: To reduce the risks of severe injury secure the machine to a stable structure.



Severe Injury Hazard

This machine is to be secured to a stable structure.

Equipment will fall if not properly secured to a stable structure.

Failure to follow these instructions may result in death, injury, product damage, or property damage.

WARNING: To reduce the risk of electrical shock, disconnect all electrical power to the machine before servicing.



Electric Shock Hazard

Disconnect all electrical power to the machine before servicing.

Electric shock will occur while servicing the machine with electrical power applied to it.

Failure to follow these instructions may result in death, injury, product damage, or property damage.

NOTICE: For indoor use only.



For indoor use only.

Solo para usos en el interior.

Pour une utilisation en intérieur uniquement.



NOTICE: Ensure this machine is level when installed



Ensure this machine is level when installed.

Asegurarse que esta máquina esté nivelada cuando haya sido instalada.

S'assurer que la machine soit de niveau lorsqu'installée.

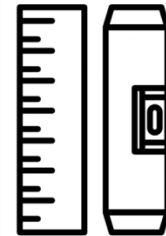

SAVE THESE INSTRUCTIONS

American Changer does not guarantee machines (products) or services to be 100% secure against criminal attempts. All machines (products) and services are to be used in accordance with business best practices and the owner's or operator's best judgement.

Installation, use, service and maintenance must be performed in accordance with applicable machine (product) manuals provided by American Changer and comply with any and all pertinent laws or regulations.

Inspect your machine (product), at a minimum annually, by a qualified service technician.

Dimensions and weights are reasonably close estimates. Specifications in this manual can vary without notice.

Section 2 – Setup & Installation

2.1 – Setup

NOTICE: THIS MODEL MACHINE IS FOR INDOOR USE ONLY.

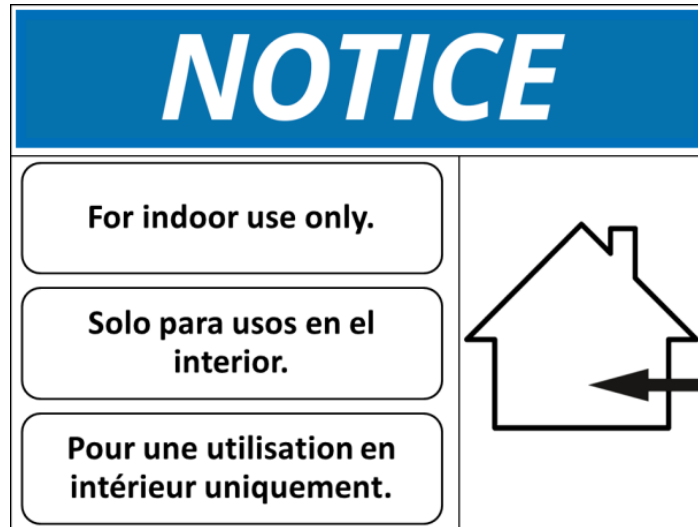

Inspect for any connectors or components that may have been dislodged during shipping. The lock and keys for your changer will be inside the manila envelope along with this manual and other pertinent information. To install the lock, insert the cylinder into the hole in the middle of the T-handle and push until it stops. Turn the key until you hear it “snap.” Turn the key counterclockwise ¼ turn and remove the keys.

NOTE: The only way to get a duplicate set of keys made is to save the tag that comes with the keys. The ID # begins with “AC” or “ACC” followed by digits.” If you purchased Medeco locks with your machine the ID will begin with “7RA” followed by digits.”

CHECKING SHIPMENT: Be sure to check the shipment against the Bill of Lading for shortages. Also, check for external damage to the packaging. Note any shortages and/or damage to the packaging on the Bill of Lading in the presence of the carrier and ask the carrier to initial on the Bill of Lading accordingly. Immediately report any shortages or damage to the packaging to the carrier and American Changer.

TEST: Before permanently installing the changer, do a functional test to verify that there is no shipping damage to your new changer.

Plug the power cord into a ***dedicated, grounded 120VAC outlet***. The machine is preset to accept \$1, \$5, \$10, and \$20 and dispense 25¢ coins (unless otherwise specified at the time of purchase).

Fill each of the coin hoppers with a minimum of 100 coins. On the Main Logic Board, turn the switch on the bottom right corner “ON.” The rocker switch has an “I” and “O” printed on it. When the “I” is pressed down, the changer is “ON.”

If the machine does not function properly please contact American Changer’s Technical Support Department at service@americanchanger.com or 1-888-741-9840.

2.2 – Mounting Instructions

This machine must be installed in accordance with local codes. If you are unsure in any way what your local codes are or unsure of anything in the following steps, please hire a licensed professional to mount your machine.

1. Disconnect any and all AC power going to the machine. (Unplug AC line cord from the rear of the machine.)
2. Note: You will need to verify with the building code enforcement to see if it is allowable to plug the changer into a grounded outlet. If it is not, there must be 120VAC run through conduit or other means to meet local codes to the changer. If it is not required, proceed to step #6.
3. Have a licensed electrician run the conduit, install the new breaker, wire and help decide how the wiring will enter the changer (from the back or the bottom).
4. After the conduit has been installed, proceed with securing the machine to a stable structure.
5. Find an appropriate stable structure which to secure the machine to.
6. **NOTICE: BEFORE SECURING ENSURE THE MACHINE IS LEVEL.**

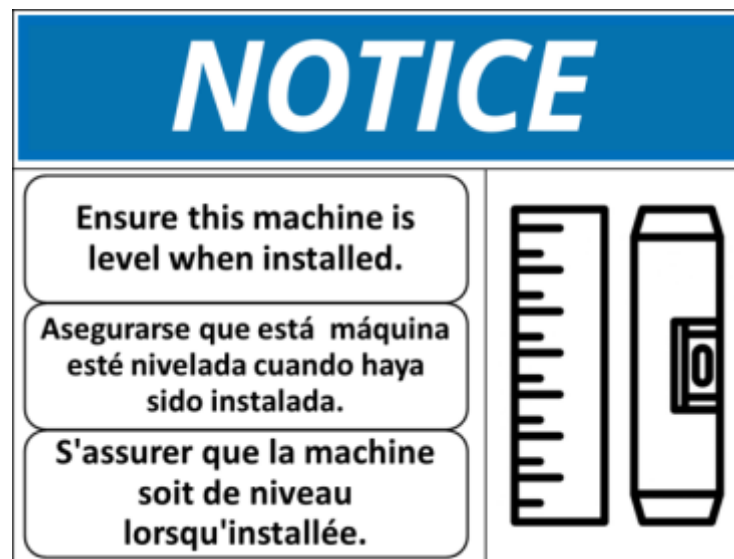

7. **⚠ DANGER**; PROPERLY SECURE MACHINE (PRODUCT) TO THE FLOOR SO THE MACHINE (PRODUCT) CANNOT BE MOVED OR TIPPED. USE STRUCTURAL SOUND FASTENERS THAT CAN BE PROPERLY TIGHTENED AND SECURE THE MACHINE (PRODUCT) THROUGH EACH OF THE HOLES IN THE BASE OF THE MACHINE (PRODUCT) TO THE APPLICABLE SURFACE TO WHICH IT IS BEING SECURED.



8. Use the four holes located in the back, bottom, or sides of the cabinet to secure the machine to a stable structure.
9. Verify that the machine is properly secured to the stable structure.
10. Connect your AC line to the outlet. If conduit was run wire it to the power supply located in the machine.
- Do not use an extension cord unless allowed by the building electrical code.**
 - Installation is completed. Proceed to the “Programming the Changer” section.

The proper performance of your American Changer machine is directly related to the quality of the power it is supplied. AC power fluctuations, including blackouts, brownouts, over voltages, sags, surges, and spikes may cause the machine to miss pay. To ensure the most trouble-free operation, we strongly recommend plugging all of our machines into a DEDICATED AC outlet (this means there are no other machines on location plugged into the same AC line). A simple way to check if this is true is to turn off the breaker associated with our machine at the breaker box. No other equipment on location should lose power.

Additionally, if your unit is located in an area prone to lightning storms or other sources of frequent power disturbances, we also strongly recommend using an Uninterruptible Power Supply (UPS). If power is lost during a payout to a customer, a UPS will allow your machines to complete the transaction that would otherwise not be completed. In some cases, a UPS may also correct long-term under and/or over voltages on the AC line by converting to the proper line voltage before the power reaches the machine.

Every American Changer machine has a surge suppressor built into the main logic board. This helps eliminate power related noise problems, but it will not protect from substantial voltage spikes or nearby lightning strikes. If this is a concern for your area, we recommend purchasing a commercial grade UPS with integrated surge protection. **NOTE: A POWER STRIP IS NOT A SURGE PROTECTOR.**

2.3 – ADA Regulations

The American Disabilities Act requires unobstructed access to equipment. Bill insertion and coin removal are to be no lower than 15 inches and no higher than 48 inches from the floor. This requirement must be met whether a changer is installed on a base, on a table, or in the wall. NOTE: This drawing is not to scale.

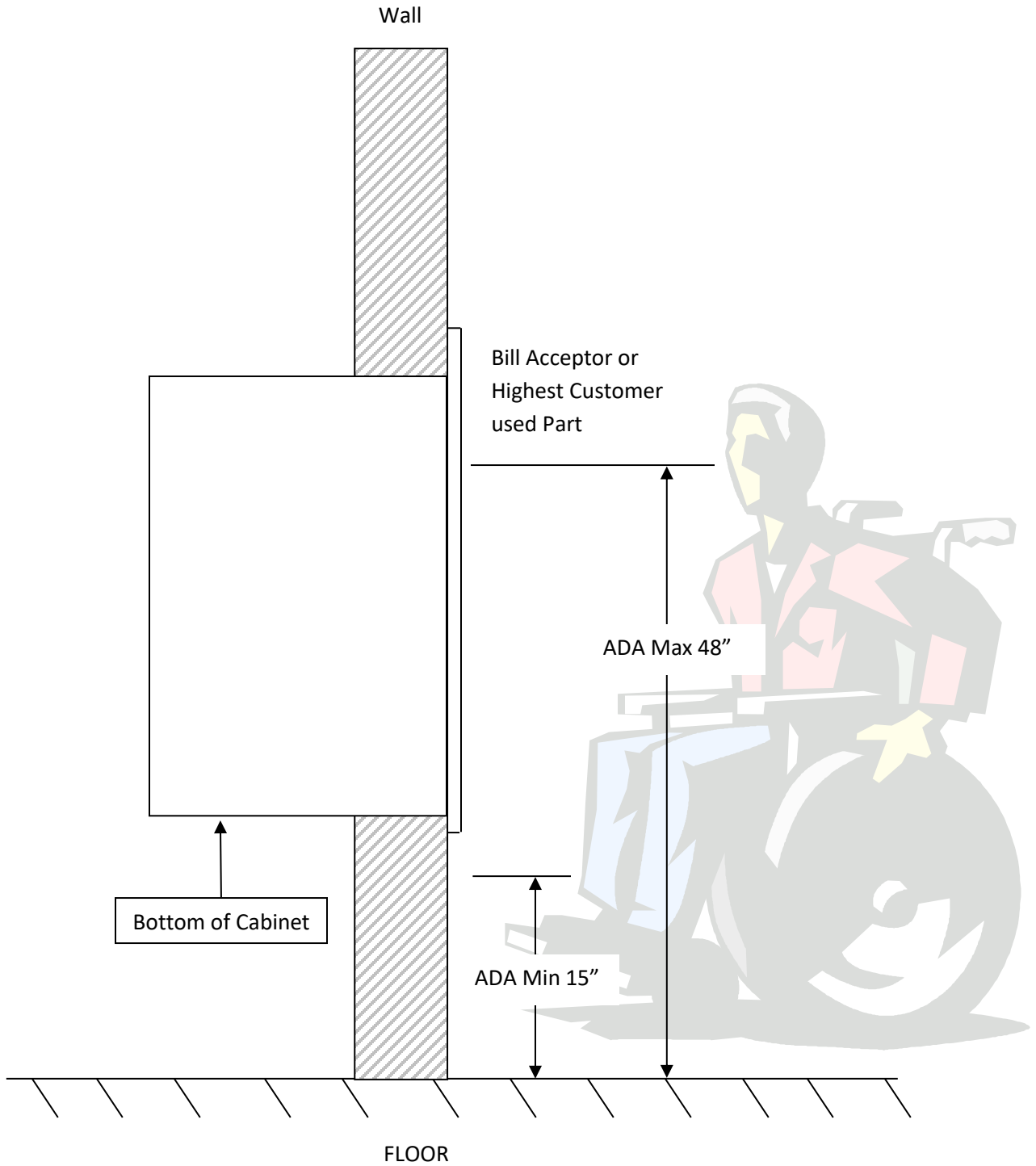

Section 3 – Operational Overview

3.1 – Component Description

Coin Hopper

The hopper uses the ccTalk communication protocol. It can dispense coins or tokens ranging in size from 21mm to 30mm in diameter and 1.25mm to 3.30mm in thickness. An option is available to dispense smaller coins.

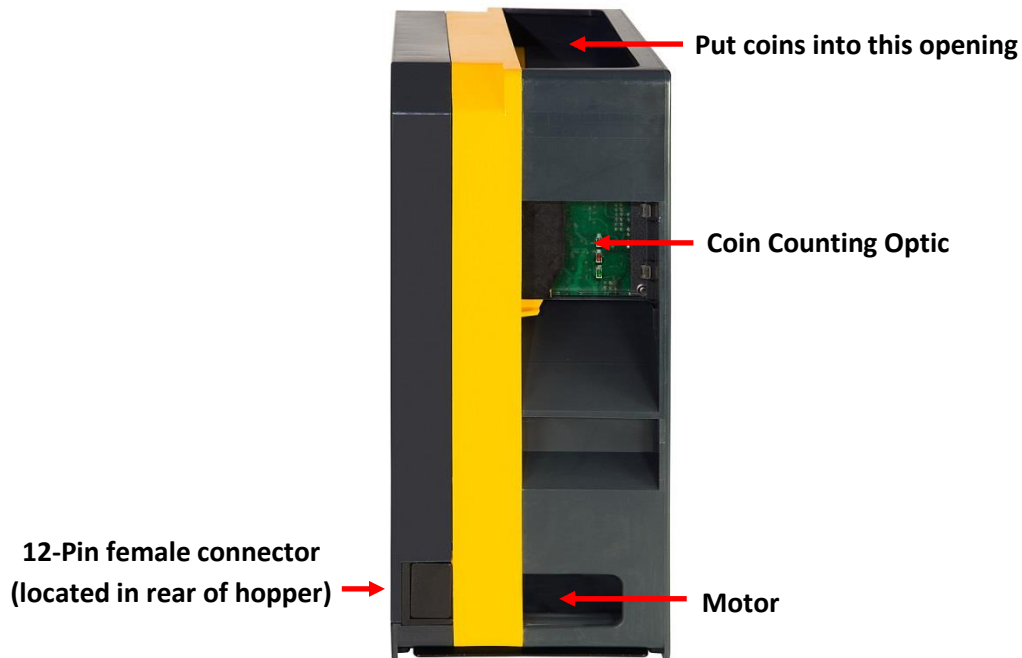

Figure 1

Bill Validator

This model machine may have been sold without a bill validator. It is intended to work with a 24VDC bill validator using the MDB protocol.

6-Pin (MDB) Connector Pinout:

- Pin #1 - +24VDC Power
- Pin #2 - DC Power return
- Pin #3 - Not Used
- Pin #4 - Master Receive
- Pin #5 - Master Transmit
- Pin #6 - Communications Common

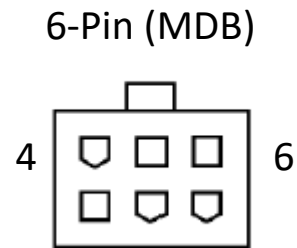

Figure 2

Universal Main Logic Board

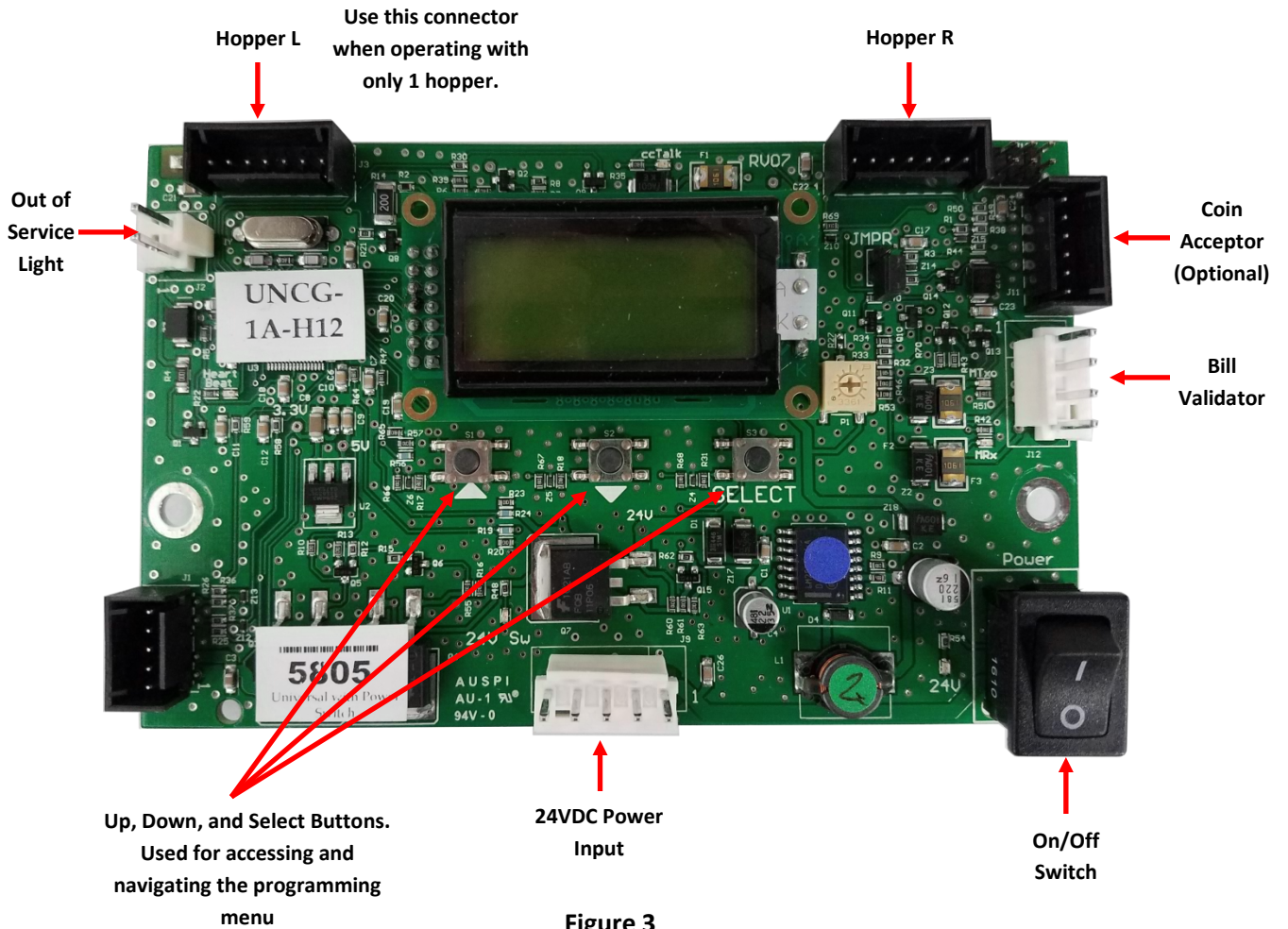

Figure 3

NOTE: The counter on the display shows money inserted. The counter is not resettable.

Super Universal Main Logic Board

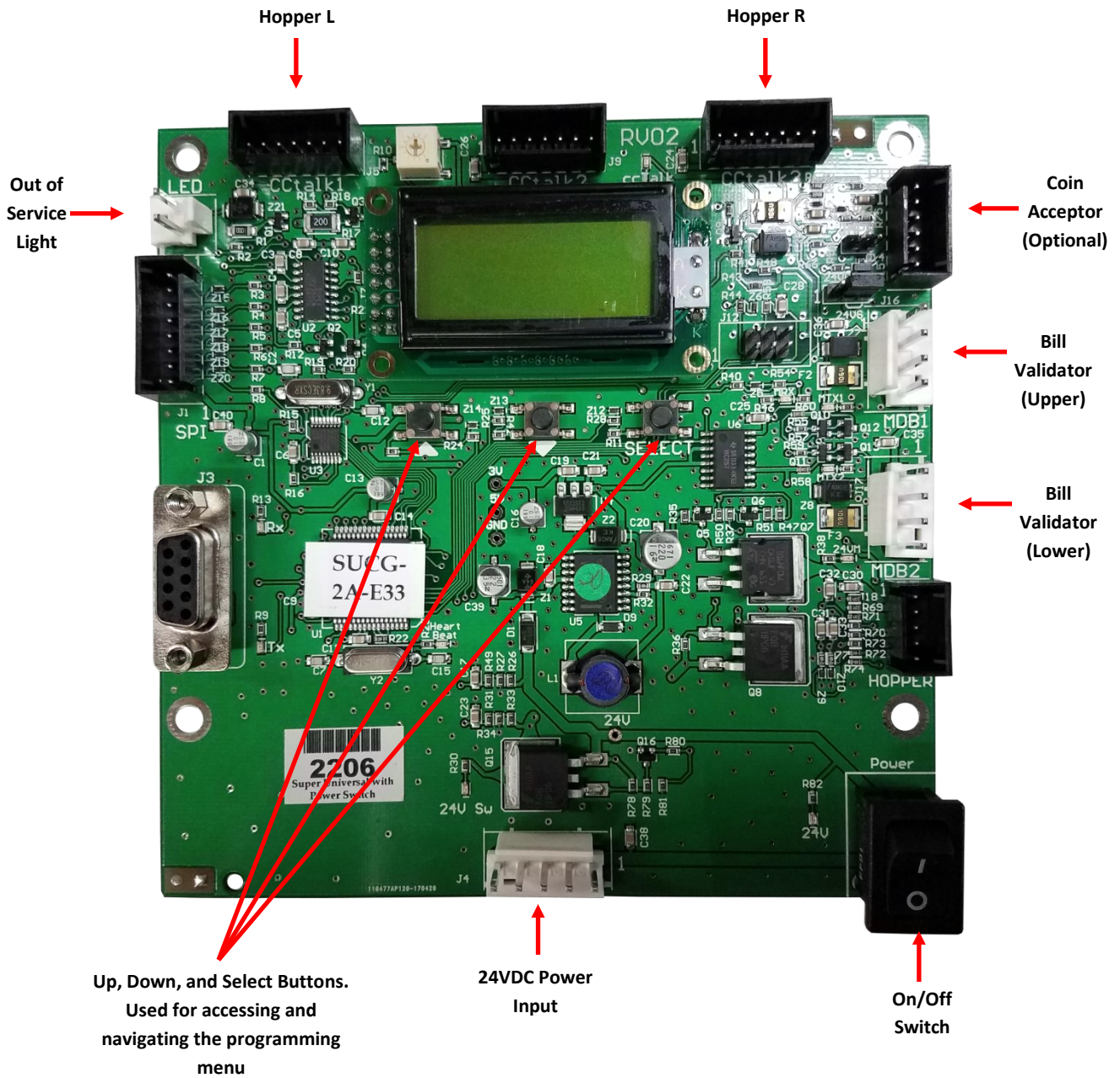

Figure 4

NOTE: The counter on the display shows money inserted. The counter is not resettable.

3.2 – Functional Description

1. **Dispense** The coin hopper content can be defined by entering its value in the programming menu, for example, \$00.25.
2. **Payment** The machine accepts payment in the form of bank notes. A coin acceptor is optional

3.3 – Out-of-Service Conditions & Error Codes

System Failures

Below are conditions that will cause the machine to go into an “Out-of-Service” mode.

Coin Hopper

Coin Hopper Error Conditions

OptoBlkd	Indicates the coin counting optic is blocked. The exit path may be obstructed, or the Optic Board may be bad.
No Comm.	The Universal Board is unable to communicate with the coin hopper. The hopper may be disconnected, have a damaged harness, or may need to be repaired or replaced.
High Current	The hopper motor exceeded its maximum threshold for current. Inspect for a jammed coin preventing the coin belt from moving, or a stalled or shorted motor. Repair or replace the hopper.
Low	The amount of coins in the coin hopper is below its operational threshold. First ensure there are enough coins in the coin hopper to completely cover the metal plates located at the bottom of the hopper. Second use Scotch-Brite to scrub the metal plates. This is effective on dull plates. Repair or replace the hopper.
TimeOut	The coin hopper did not complete a payout in its allotted time frame. Check the hopper for any coin jams or mechanical obstructions preventing coins from exiting. Have the unit repaired or replaced.
Fraud	The optic sensor detected something outside of a dispensing cycle. Inspect for a jammed coin or other obstruction near exit window; repair or replace the hopper.

Bill Validator	NoPay	A dispense command was sent to the coin hopper but it did not dispense any coins. Check the hopper for a possible coin jam, exit blockage, or other mechanical errors. If nothing can be found, have the unit repaired or replaced. Bill Validator Error Conditions
	Motor	Validator stacker/transport motor has failed. Repair or replace the bill validator.
	Sensor	Sensor failure. Check for dirty sensors. Repair or replace the validator.
	Checksum	Indicates error with the firmware file stored on validator main board. Repair or replace the bill validator.
	Jammed	A bill or debris is jammed in the validator bill path. Check bill path for a jammed bill or debris. Repair or replace the bill validator.
	Cashbox	The cashbox is not installed on the bill validator. Ensure the bill box is properly installed on the bill validator. Repair or replace the bill validator.
	No Comm.	The Universal Board is unable to communicate with the bill validator. Ensure the validator harness is connected securely. Repair or replace the bill validator.
	Can't Enable	The Universal Board has tried to enable the validator several times without success.

3.4 – Programming Menu Universal Board

To enter the programming menu, begin by pressing the “Select” button on the Universal main logic board. Refer to Figure 3.

Use the “Up ▲” and “Down ▼” buttons to navigate through the menus. Scroll down to “Exit” and press the “Select” button to exit the programming menu.

Bills

Accept – This menu controls which bills are accepted and rejected by the bill validator. To accept a bill set the denomination option to “Y”. To reject a bill set the denomination option to “N”.

Security – This menu controls how strict the bill validator is reading the bills.

Total 00000	Bills	Accept	\$1	\$5	\$10	\$20	\$50	\$100	
			Y	Y	Y	Y	Y	Y	
			N	N	N	N	N	N	
		Exit	Exit	Exit	Exit	Exit	Exit	Exit	
		Security	High						
			Low						
			Exit						
		Exit							

Coins

This menu is used if a ccTalk coin acceptor is installed in the machine. It controls which coins are accepted and rejected by the coin acceptor. To accept a coin set the denomination option to “Y”. To reject a coin set the denomination option to “N”.

Total 00000	Coins *U.S. Acceptor Selected	5¢	10¢	25¢	\$1
		Y	Y	Y	Y
		N	N	N	N
		Exit	Exit	Exit	Exit

Payout and Mode Menus

Payout – This menu is used to define how the machine will payout. This menu will change depending on the mode selected.

Mode – This menu is a submenu of the Hardware menu. Which mode is used is determined by the manner in which the machine is to be used.

Simple Vend Mode (S Vend) – This mode allows the machine to vend tokens only if the machine has one hopper, or vend tokens from the left hopper and change from the right if the machine is equipped with two hoppers. If this mode is selected, the program prompts you to select the number of tokens to be dispensed – One or Many. For two hoppers, ‘One’ means that one token will be dispensed, and change will be made for the remaining balance, if any. ‘Many’ means that the hopper will dispense as many tokens as possible for the money denomination accepted, and change will be made for the remaining balance, if any. Token and change values are set in the ‘Payout’ menu. For one hopper, since no change is available, the changer defaults to ‘Many,’ changing the full amount to tokens. Discounts or bonus payouts are not possible using Simple Vending mode.

Simple Vend with 1 Hopper – Use the “Up▲” and “Down▼” buttons to set the value of the tokens in the hopper. The token value can be set to anywhere between 1¢ and \$20. Press the Select button to save the value entered.

Example: Set Token = \$0.25 to pay out 4 tokens per dollar.

Total	Payout	Token Value
00000	Simple Vend 1 Hopper	Value \$00.25

Simple Vend with 2 Hoppers – Enter a token value for the left hopper (‘Token L’), and enter the denomination of the coins being dispensed from the right hopper (‘Change R’). Both can be set to values between 1¢ and \$20.

Example: With the mode set to ‘many’, set Token L = \$0.30, and Change R = \$0.05 (fill the right hopper with nickels). Inserting a \$5 bill will pay out 16 tokens (\$4.80) and 4 nickels (\$0.20). With the mode set to ‘one’, the payout will be 1 token (\$0.30) and 94 nickels (\$4.70) for the same \$5 bill.

Total	Payout	Token L Value	Change R Value
00000	Simple Vend 2 Hoppers	Value \$00.30	Value \$00.05

Game Token (Gmetkns) Mode – This mode is intended for vending tokens only. It allows for the use of “Party Tokens.” Payouts per denomination, and up to 4 different “Party Tokens,” can be set independently, giving the option of including discounts or bonuses for certain denominations. If the changer is equipped with two hoppers, both should be filled with the same tokens.

If changer is equipped with two hoppers, both should be filled with the same tokens for this mode. Here, set the number of tokens to be paid out per money denomination accepted, starting with the quarter, and proceeding, in increasing order, all the way to the \$100 bill. (Only the denominations that have been set for acceptance in the ‘Bill’ and ‘Coin’ menus and on the validator will show up.) Then, continue by setting the number of tokens to be paid out for up to 4 different “Party Tokens.” Press Up or Down (buttons #1 or #2), then Select to set the payouts. Each number can be set to anywhere between 0 and 999 tokens.

Example: Set \$Q = 1, \$1 = 4, \$5 = 22, and \$TKN1 = 100. This will pay out 4 tokens per dollar with a 2 token bonus for changing a \$5 bill, and 100 tokens upon acceptance of “Party Token” #1. In this example no payout is set for \$10, \$20, \$50, \$100, TKN2, TKN3, and TKN4.

Total 0000	Pay- out	\$Q	\$1	\$5	\$10	\$20	\$50	\$100	TKN1	TKN2	TKN3	TKN4
		001	004	022					100			

Simple Changer (S Chngr) Mode – This is the most basic mode. A coin or bill is fully changed into the denomination(s) of coins in the hopper(s) without discounts or bonus payouts. This mode can be used with one or two hoppers. If two hoppers are installed, they can each be filled with the same or different denomination coins with which to make change. The program will prompt you to enter whether the coins in the hoppers are the same (Same) or different (Diff). Payouts settings are per dollar.

Simple Changer with 1 Hopper or 2 Hoppers with the same Coins – Enter the denomination of coins in the hopper(s). This value can be set to anywhere between 1¢ and \$20. Use the Up button to increase the value and the Down button to decrease it, and push the Select button to save.

Example: Set Change = \$0.25 to pay out 4 quarters per dollar.

Total 00000	Payout 1 or 2 Hoppers w/ Same Coins	Change Set Value \$00.25

Simple Changer with 2 Hoppers and Different Coins – Begin by entering the denomination of coins in the left ('Change L') and right ('Change R') hoppers. These values can be set to anywhere between 1¢ and \$20. Next, set the number of coins from each to be paid out per dollar for each changing operation. The left hopper is first ('Payout L'), then the right ('Payout R'). *Note: The 'Payout' settings override the 'Change' value settings, so be sure to correctly enter how many of each coin you want dispensed per dollar.*

Example: Set Change L = \$0.25, Change R = \$0.05, Payout L = 3, and Payout R = 5 to pay out 3 quarters and 5 nickels per dollar.

Total	Payout	Change L	Change R	Payout L	Payout R
00000	Different Coins	\$00.25	\$00.05	003	005

Advanced Changer (A Chngr) Mode – This mode is designed for two hoppers only, each filled with different coins. This is the most configurable changer mode, as it allows independent changing options to be set for each coin and bill accepted. Individual payouts from both the left and right hoppers can be set for each money denomination, allowing for a broad variety in the types of payouts that can be set, including discounts for certain bills and bonuses, if desired.

Advanced Changer with 2 Hoppers and Different Coins – First, enter the denomination of coins in both the left hopper ('Change L') and the right ('Change R'). These values can be set to anywhere between 1¢ and \$20. Then, set the number of coins to be paid out of each hopper per denomination, starting with the left hopper payout per quarter ('\$Q L'), then the right hopper payout per quarter ('\$Q R'), then left and right payouts per dollar, and so on, up through payouts per \$100 bill. Those denominations that are not enabled are skipped. *Note: The 'Payout' settings override the 'Change' value settings, so be sure to correctly enter how many of each coin you want dispensed per denomination.*

Example: To pay out exactly 5 nickels per denomination, with the balance to be paid in quarters, the settings would be: Change L = \$0.25, Change R = \$0.05, \$Q L = 0, \$Q R = 5, \$1 L = 3, \$1 R = 5, \$5 L = 19, \$5 R = 5, \$10 L = 39, \$10 R = 5, etc.... In this example no payout is set for the \$50 and \$100.

Total	Payout	Change L	Change R	\$QL	\$1L	\$5L	\$10L	\$20L	\$50L	\$100L
00000		\$00.25	\$00.05	000	003	019	039	079		
				\$QR	\$1R	\$5R	\$10R	\$20R	\$50R	\$100R
				005	005	005	005	005		

Advanced Vending (A Vend) Mode – This mode is a further adjustable version of the Simple Vending mode, adding the capability of setting individual payouts per each accepted denomination. When two hoppers are used for this mode, unlike in Simple vending mode, you have the option of filling them with the same or different coins (select 'Same' or 'Diff.' after selecting this mode). If they are both filled with the same tokens, the changer works the same as with one hopper. If 'different' is selected, the left hopper should contain tokens, while the right should contain coins for change. All payouts are configurable for each accepted money denomination; you set how many tokens and how much change is paid out for each transaction.

Advanced Vending 1 or 2 Hoppers with the Same Coin – Using the “Up ▲” and “Down ▼” buttons, set the value of the tokens in the hopper(s). They can be set to values between 1¢ and \$20. Following this, enter the number of tokens to be dispensed for each accepted bill denomination, starting with \$1 and increasing, in sequence, to \$100. Any number between 0 and 999 can be chosen for each, giving you the option of including discounts or bonus payouts starting at \$1 bills.

Example: Set Token = \$0.50, \$1 = 2, \$5 = 12, and \$10 = 25 to pay out 2 tokens per dollar with a 2-token bonus for \$5 bills, and a 5-token bonus for \$10 bills. In this example no payout is set for the \$20, \$50 and \$100.

Total	Payout	Token Value	\$1	\$5	\$10	\$20	\$50	\$100
00000	Same Token	\$00.50	002	012	025			

Advanced Vending with 2 Hoppers and Different Coins – This mode requires that the left-side hopper contain tokens, and the right-side hopper contain coins for change. First, select the value of the tokens in the left hopper (‘Token L’), and then enter the coin denominations in the right hopper (‘Change R’). Then, in sequence, enter the desired number of each to be paid out for each bill value accepted by the validator. The program will prompt for each value starting with the token payout per one-dollar bill (‘\$1 L’) and change given (‘\$1 R’). This is followed by the token and change payout per \$2 bill (if enabled), and so on, up through the payouts per \$100 bill. *Note: The ‘Payout’ numbers override the ‘Token’ and ‘Change’ value settings, so be sure to correctly enter how many of each you want the changer to dispense per denomination.*

Example: To dispense two-dollar tokens and give some change in quarters for every bill accepted, set Token L = \$2.00, Change R = \$0.25, \$2 L = 1, \$2 R = 0, \$5 L = 2, \$5 R = 4, \$10 L = 4, \$10 R = 8, \$20 L = 9, \$20 R = 8, etc.... In this example no payout is set for the \$50 and \$100.

Total	Payout	Token L	Change R	\$1L	\$5L	\$10L	\$20L	\$50L	\$100L
00000	Different Tokens	\$02.00	\$00.25	N/A	002	004	009		
				\$1R	\$5R	\$10R	\$20R	\$50R	\$100R
				N/A	004	008	008		

NOTE: After setting the payout always perform a test to ensure the payout is set correctly. Do not put into operation before testing.

Hardware – These submenus are used to configure the different devices installed in the machine (Banknote validator, Coin Acceptor, and the Universal Board). The machine will arrive with this information preset and will not require any changes to be made.

Hoppers – Configures the machine to operate with 1 or 2 ccTalk hoppers or a Compact hopper. This model operates with 1 ccTalk hopper.

cctalk – Select ccTalk if using one or more hoppers with a ccTalk serial interface to the Universal Board. Once selected, enter the number of ccTalk hoppers – one or two – to be used in the changer. *Note: Each Logic Board has the capacity to control two ccTalk hoppers, left and right; but, if only one is used, it must be plugged into the left-side connector (see Figure 3 for the ccTalk device connections.) If your model changer has two Logic Boards and two hoppers, then only one hopper will be controlled by each board; select '1' as the number of ccTalk hoppers on both boards.*

Compact – If using a Compact hopper select “Compact”. No other selections are necessary.

Coin Acceptor – Configures the machine to operate with a cctalk or pulse coin acceptor.

cctalk – This option should be selected if the installed coin acceptor communicates with the Universal Board using ccTalk serial communication protocol (see Figure 3 for the ccTalk device connections .) After choosing ccTalk, the program prompts for specification of the currency type that will be processed by the coin acceptor. Choose either US or Canadian coins.

Pulse – If the installed coin acceptor communicates with the Universal Board using pulse protocol, select ‘Pulse’. Following this, the program will request specification of the logic level used to enable the coin acceptor, high “Hi” or low “Lo”. Pulse coin acceptors provided by American Changer use the “Hi” setting. *Note: The Logic Board can only control one pulse device; if a pulse validator is installed, a pulse coin acceptor cannot be* (see Figure 3 for the pulse device connection on the Universal Board).

None – Select this if a coin acceptor is not being used.

Validator – Configures the machine to operate with a validator using MDB protocol or serial Pulse protocol.

MDB: Select ‘MDB,’ and then enter how many MDB validators are installed in the changer – either one (1) or zero (None!). (See Figure 3 for the MDB validator connection on the Universal Board.)

Pulse: Select ‘Pulse,’ and then choose either one (1) or zero (None!) to specify the number of pulse validators that are inside the unit. If ‘1’ is chosen, then the program will further prompt for whether the validator is enabled using a logic-high (Hi) or a logic-low (Lo) signal; either must be chosen. *Note: The Logic Board can only control one pulse device; if a pulse coin acceptor is installed, a pulse validator cannot be.* (See Figure 3 for the pulse device connection on the Universal Board.)

String – Configures the settings that help against “Stringing”. Select ‘String,’ and then choose either (Y) to enable stringing protection, or (N) to disable it. If Yes is chosen, there is a series of three settings that will follow, explained next, that together control the behavior of the changer with regard to stringing.

Max \$ – This setting is the maximum dollar amount that can be accepted by the machine within the user-set time limit (next setting) before triggering the anti-stringing protection. The dollar amount can be chosen anywhere between \$20 and \$200 in \$5 increments.

Max Time – The time entered here is the time limit for the changer accepting the user-set maximum dollar amount (previous setting). If the changer accepts the maximum dollar amount within the amount of time set here, anti-stringing protection will be triggered. The length of time can be set to anywhere between 5 and 120 minutes in 5 minute increments.

Shut Off – This setting controls the anti-stringing protection, which is the shutting down of the changer for the time specified here. The changer can be set to shut down for 15, 30, 45, or 60 minutes, or until the MLB is reset by turning the power off then back on (‘Reset’).

Dump – This menu will enable or disable the “Dump” function. To enable the “Dump” function set to “Y”. To disable the dump function set to “N”.

Using the Dump Feature

1. Open the machine door to gain access to the Universal Board.
2. Have a container suitable for holding a large quantity of coins ready as this will be used to catch the coins as they are dispensed.
3. On the Universal Board press and hold the “Up ▲” and “Down ▼” buttons simultaneously. The LCD display on the Universal Board will display “Start Dump?”. Press the “Select” button to begin the dumping the coin hopper(s).
4. The hopper(s) will continue to dump until the “Select” button is pressed a second time or the machine is turned off.
5. A count of the coins dispensed will be shown on the Universal Board’s LCD display. This will stay on the display until the machine is turned off.

Programming Menu Flow Chart

Total 00000	Hardware	Hoppers	Hoppers	ccTalk	1		
					2		
					Exit		
			Compact				
			Exit				
		Coin Acceptor	Coin Acceptor	ccTalk	U.S.		
					CAN		
					Exit		
			Pulse	High			
				Low			
				Exit			
			None				
			Exit				
		Validator	Validator	MDB	1		
					None		
					Exit		
			Pulse	1	High		
					Low		
					Exit		
			None				
			Exit				
		String	String	Yes	Max \$		
					Max Time		
					Shut Off		
			No				
			Exit				
		Dump	Dump	Y			
	N						
Exit							
Mode							
Exit							

3.5 – Programming Menu Super Universal Board

To enter the programming menu, begin by pressing the “Select” button on the Super Universal main logic board. Refer to Figure 3.

Use the “Up ▲” and “Down ▼” buttons to navigate through the menus. Scroll down to “Exit” and press the “Select” button to exit the programming menu.

Bills

Accept – This menu controls which bills are accepted and rejected by the bill validator. To accept a bill set the denomination option to “Y”. To reject a bill set the denomination option to “N”.

Security – This menu controls how strict the bill validator is reading the bills.

Total 00000	Bills	Valid. Upper	Accept	\$1	\$5	\$10	\$20	\$50	\$100
				Y	Y	Y	Y	Y	Y
				N	N	N	N	N	N
		Exit	Exit	Exit	Exit	Exit	Exit		
		Valid. Lower	Security	High					
				Low					
	Exit								
		Exit							

Coins

This menu is used if a ccTalk coin acceptor is installed in the machine. It controls which coins are accepted and rejected by the coin acceptor. To accept a coin set the denomination option to “Y”. To reject a coin set the denomination option to “N”.

Total 00000	Coins *U.S. Acceptor Selected	5¢	10¢	25¢	\$1
		Y	Y	Y	Y
		N	N	N	N
		Exit	Exit	Exit	Exit

Payout and Mode Menus

Payout – This menu is used to define how the machine(s) will payout. This menu will change depending on the mode selected.

Mode – This menu is a submenu of the Hardware menu. Which mode is used is determined by the manner in which the machine is to be used.

Simple Vend Mode (S Vend) – This mode allows the machine to vend tokens only if the machine has one hopper, or vend tokens from the left hopper and change from the right if the machine is equipped with two hoppers. If this mode is selected, the program prompts you to select the number of tokens to be dispensed – One or Many. For two hoppers, ‘One’ means that one token will be dispensed, and change will be made for the remaining balance, if any. ‘Many’ means that the hopper will dispense as many tokens as possible for the money denomination accepted, and change will be made for the remaining balance, if any. Token and change values are set in the ‘Payout’ menu. For one hopper, since no change is available, the changer defaults to ‘Many,’ changing the full amount to tokens. Discounts or bonus payouts are not possible using Simple Vending mode.

Simple Vend with 1 Hopper – Use the “Up▲” and “Down▼” buttons to set the value of the tokens in the hopper. The token value can be set to anywhere between 1¢ and \$20. Press the Select button to save the value entered.

Example: Set Token = \$0.25 to pay out 4 tokens per dollar.

Total	Payout	Token Value
00000	Simple Vend 1 Hopper	Value \$00.25

Simple Vend with 2 Hoppers – Enter a token value for the left hopper (‘Token L’), and enter the denomination of the coins being dispensed from the right hopper (‘Change R’). Both can be set to values between 1¢ and \$20.

Example: With the mode set to ‘many’, set Token L = \$0.30, and Change R = \$0.05 (fill the right hopper with nickels). Inserting a \$5 bill will pay out 16 tokens (\$4.80) and 4 nickels (\$0.20). With the mode set to ‘one’, the payout will be 1 token (\$0.30) and 94 nickels (\$4.70) for the same \$5 bill.

Total	Payout	Token L Value	Change R Value
00000	Simple Vend 2 Hoppers	Value \$00.30	Value \$00.05

Game Token (Gmetkns) Mode – This mode is intended for vending tokens only. It allows for the use of “Party Tokens.” Payouts per denomination, and up to 4 different “Party Tokens,” can be set independently, giving the option of including discounts or bonuses for certain denominations. If the changer is equipped with two hoppers, both should be filled with the same tokens.

If changer is equipped with two hoppers, both should be filled with the same tokens for this mode. Here, set the number of tokens to be paid out per money denomination accepted, starting with the quarter, and proceeding, in increasing order, all the way to the \$100 bill. (Only the denominations that have been set for acceptance in the ‘Bill’ and ‘Coin’ menus and on the validator will show up.) Then, continue by setting the number of tokens to be paid out for up to 4 different “Party Tokens.” Press Up or Down (buttons #1 or #2), then Select to set the payouts. Each number can be set to anywhere between 0 and 999 tokens.

Example: Set \$Q = 1, \$1 = 4, \$5 = 22, and \$TKN1 = 100. This will pay out 4 tokens per dollar with a 2 token bonus for changing a \$5 bill, and 100 tokens upon acceptance of “Party Token” #1. In this example no payout is set for \$10, \$20, \$50, \$100, TKN2, TKN3, and TKN4.

Total 0000	Pay- out	\$Q	\$1	\$5	\$10	\$20	\$50	\$100	TKN1	TKN2	TKN3	TKN4
		001	004	022					100			

Simple Changer (S Chngr) Mode – This is the most basic mode. A coin or bill is fully changed into the denomination(s) of coins in the hopper(s) without discounts or bonus payouts. This mode can be used with one or two hoppers. If two hoppers are installed, they can each be filled with the same or different denomination coins with which to make change. The program will prompt you to enter whether the coins in the hoppers are the same (Same) or different (Diff). Payouts settings are per dollar.

Simple Changer with 1 Hopper or 2 Hoppers with the same Coins – Enter the denomination of coins in the hopper(s). This value can be set to anywhere between 1¢ and \$20. Use the Up button to increase the value and the Down button to decrease it, and push the Select button to save.

Example: Set Change = \$0.25 to pay out 4 quarters per dollar.

Total 00000	Payout 1 or 2 Hoppers w/ Same Coins	Change Set Value \$00.25

Simple Changer with 2 Hoppers and Different Coins – Begin by entering the denomination of coins in the left ('Change L') and right ('Change R') hoppers. These values can be set to anywhere between 1¢ and \$20. Next, set the number of coins from each to be paid out per dollar for each changing operation. The left hopper is first ('Payout L'), then the right ('Payout R'). *Note: The 'Payout' settings override the 'Change' value settings, so be sure to correctly enter how many of each coin you want dispensed per dollar.*

Example: Set Change L = \$0.25, Change R = \$0.05, Payout L = 3, and Payout R = 5 to pay out 3 quarters and 5 nickels per dollar.

Total	Payout	Change L	Change R	Payout L	Payout R
00000	Different Coins	\$00.25	\$00.05	003	005

Advanced Changer (A Chngr) Mode – This mode is designed for two hoppers only, each filled with different coins. This is the most configurable changer mode, as it allows independent changing options to be set for each coin and bill accepted. Individual payouts from both the left and right hoppers can be set for each money denomination, allowing for a broad variety in the types of payouts that can be set, including discounts for certain bills and bonuses, if desired.

Advanced Changer with 2 Hoppers and Different Coins – First, enter the denomination of coins in both the left hopper ('Change L') and the right ('Change R'). These values can be set to anywhere between 1¢ and \$20. Then, set the number of coins to be paid out of each hopper per denomination, starting with the left hopper payout per quarter ('\$Q L'), then the right hopper payout per quarter ('\$Q R'), then left and right payouts per dollar, and so on, up through payouts per \$100 bill. Those denominations that are not enabled are skipped. *Note: The 'Payout' settings override the 'Change' value settings, so be sure to correctly enter how many of each coin you want dispensed per denomination.*

Example: To pay out exactly 5 nickels per denomination, with the balance to be paid in quarters, the settings would be: Change L = \$0.25, Change R = \$0.05, \$Q L = 0, \$Q R = 5, \$1 L = 3, \$1 R = 5, \$5 L = 19, \$5 R = 5, \$10 L = 39, \$10 R = 5, etc.... In this example no payout is set for the \$50 and \$100.

Total	Payout	Change L	Change R	\$QL	\$1L	\$5L	\$10L	\$20L	\$50L	\$100L
00000		\$00.25	\$00.05	000	003	019	039	079		
				\$QR	\$1R	\$5R	\$10R	\$20R	\$50R	\$100R
				005	005	005	005	005		

Advanced Vending (A Vend) Mode – This mode is a further adjustable version of the Simple Vending mode, adding the capability of setting individual payouts per each accepted denomination. When two hoppers are used for this mode, unlike in Simple vending mode, you have the option of filling them with the same or different coins (select 'Same' or 'Diff.' after selecting this mode). If they are both filled with the same tokens, the changer works the same as with one hopper. If 'different' is selected, the left hopper should contain tokens, while the right should contain coins for change. All payouts are configurable for each accepted money denomination; you set how many tokens and how much change is paid out for each transaction.

Advanced Vending 1 or 2 Hoppers with the Same Coin – Using the “Up ▲” and “Down ▼” buttons, set the value of the tokens in the hopper(s). They can be set to values between 1¢ and \$20. Following this, enter the number of tokens to be dispensed for each accepted bill denomination, starting with \$1 and increasing, in sequence, to \$100. Any number between 0 and 999 can be chosen for each, giving you the option of including discounts or bonus payouts starting at \$1 bills.

Example: Set Token = \$0.50, \$1 = 2, \$5 = 12, and \$10 = 25 to pay out 2 tokens per dollar with a 2-token bonus for \$5 bills, and a 5-token bonus for \$10 bills. In this example no payout is set for the \$20, \$50 and \$100.

Total	Payout	Token Value	\$1	\$5	\$10	\$20	\$50	\$100
00000	Same Token	\$00.50	002	012	025			

Advanced Vending with 2 Hoppers and Different Coins – This mode requires that the left-side hopper contain tokens, and the right-side hopper contain coins for change. First, select the value of the tokens in the left hopper (‘Token L’), and then enter the coin denominations in the right hopper (‘Change R’). Then, in sequence, enter the desired number of each to be paid out for each bill value accepted by the validator. The program will prompt for each value starting with the token payout per one-dollar bill (‘\$1 L’) and change given (‘\$1 R’). This is followed by the token and change payout per \$2 bill (if enabled), and so on, up through the payouts per \$100 bill. *Note: The ‘Payout’ numbers override the ‘Token’ and ‘Change’ value settings, so be sure to correctly enter how many of each you want the changer to dispense per denomination.*

Example: To dispense two-dollar tokens and give some change in quarters for every bill accepted, set Token L = \$2.00, Change R = \$0.25, \$2 L = 1, \$2 R = 0, \$5 L = 2, \$5 R = 4, \$10 L = 4, \$10 R = 8, \$20 L = 9, \$20 R = 8, etc.... In this example no payout is set for the \$50 and \$100.

Total	Payout	Token L	Change R	\$1L	\$5L	\$10L	\$20L	\$50L	\$100L
00000	Different Tokens	\$02.00	\$00.25	N/A	002	004	009		
				\$1R	\$5R	\$10R	\$20R	\$50R	\$100R
				N/A	004	008	008		

NOTE: After setting the payout always perform a test to ensure the payout is set correctly. Do not put into operation before testing.

Hardware – These submenus are used to configure the different devices installed in the machine (Banknote validator, Coin Acceptor, and the Universal Board). The machine will arrive with this information preset and will not require any changes to be made.

Hoppers – Configures the machine to operate with 1 or 2 ccTalk hoppers or a Compact hopper. This model operates with 1 ccTalk hopper.

ccTalk – Select ccTalk if using one or more hoppers with a ccTalk serial interface to the Universal Board. Once selected, enter the number of ccTalk hoppers – one or two – to be used in the changer. *Note: Each Logic Board has the capacity to control two ccTalk hoppers, left and right; but, if only one is used, it must be plugged into the left-side connector (see Figure 3 for the ccTalk device connections.) If your model changer has two Logic Boards and two hoppers, then only one hopper will be controlled by each board; select '1' as the number of ccTalk hoppers on both boards.*

Compact – If using a Compact hopper select “Compact”. No other selections are necessary.

Coin Acceptor – Configures the machine to operate with a cctalk or pulse coin acceptor.

ccTalk – This option should be selected if the installed coin acceptor communicates with the Super Universal Board using ccTalk serial communication protocol (see Figure 3 for the ccTalk device connections .) After choosing ccTalk, the program prompts for specification of the currency type that will be processed by the coin acceptor. Choose either US or Canadian coins.

Pulse – If the installed coin acceptor communicates with the Universal Board using pulse protocol, select ‘Pulse’. Following this, the program will request specification of the logic level used to enable the coin acceptor, high “Hi” or low “Lo”. Pulse coin acceptors provided by American Changer use the “Hi” setting. *Note: The Logic Board can only control one pulse device; if a pulse validator is installed, a pulse coin acceptor cannot be* (see Figure 3 for the pulse device connection on the Super Universal Board).

Pulse V: If the installed coin acceptor uses a mechanical switch, select ‘Pulse V’. Following this, the software will request specification of the logic level used to enable the coin acceptor, high (H) or low (Lo). The software will then request the desired value of the coin. (See Figure 3 for the pulse device connection on the Super Universal Board.)

None – Select this if a coin acceptor is not being used.

Validator – Configures the machine to operate with a validator using MDB protocol or serial Pulse protocol.

MDB: Select ‘MDB,’ and then enter how many MDB validators are installed in the changer – either one (1), two (2), or zero (None!). (See Figure 3 for the MDB validator connection on the Super Universal Board.)

String – Configures the settings that help against “Stringing”. Select ‘String,’ and then choose either (Y) to enable stringing protection, or (N) to disable it. If Yes is chosen, there is a series of three settings that will follow, explained next, that together control the behavior of the changer with regard to stringing.

Max \$ – This setting is the maximum dollar amount that can be accepted by the machine within the user-set time limit (next setting) before triggering the anti-stringing protection. The dollar amount can be chosen anywhere between \$20 and \$200 in \$5 increments.

Max Time – The time entered here is the time limit for the changer accepting the user-set maximum dollar amount (previous setting). If the changer accepts the maximum dollar amount within the amount of time set here, anti-stringing protection will be triggered. The length of time can be set to anywhere between 5 and 120 minutes in 5 minute increments.

Shut Off – This setting controls the anti-stringing protection, which is the shutting down of the changer for the time specified here. The changer can be set to shut down for 15, 30, 45, or 60 minutes, or until the MLB is reset by turning the power off then back on (‘Reset’).

Dump – This menu will enable or disable the “Dump” function. To enable the “Dump” function set to “Y”. To disable the dump function set to “N”.

Using the Dump Feature

1. Open the machine door to gain access to the Universal Board.
2. Have a container suitable for holding a large quantity of coins ready as this will be used to catch the coins as they are dispensed.
3. On the Universal Board press and hold the “Up ▲” and “Down ▼” buttons simultaneously. The LCD display on the Universal Board will display “Start Dump?”. Press the “Select” button to begin the dumping the coin hopper(s).
4. The hopper(s) will continue to dump until the “Select” button is pressed a second time or the machine is turned off.
5. A count of the coins dispensed will be shown on the Universal Board’s LCD display. This will stay on the display until the machine is turned off.

Programming Menu Flow Chart

Total 00000	Hardware	Hoppers	Hoppers	ccTalk	ccTalk	
			ccTalk	1		
				2		
				Exit		
			Compact			
			Exit			
		Coin Acceptor	Coin Acceptor	ccTalk	ccTalk	
				U.S.		
				CAN		
				Exit		
			Pulse	Pulse		
				High		
				Low		
				Exit		
			Pulse V	Pulse V	Pulse V	
				High	\$00.00	
				Low		
				Exit		
		None				
		Exit				
		Validator	Validator	MDB		
			MDB	1		
				2		
				None		
				Exit		
			Pulse	Pulse	1	1
					High	
					Low	
				Exit		
			None			
			Exit			
		Exit				
		Exit				

Programming Menu Flow Chart Continued

Total 00000	Hardware	String	String	Yes	Max \$
			Yes	Max Time	
			No	Shut Off	
			Exit		
			Exit		
		Dump	Dump	Y	
			N		
			Exit		
		Credit	Swipe		
			\$00.00		
		Mode			
		Exit			

Section 4 – Maintenance

⚠️ WARNING : DISCONNECT ALL ELECTRICAL POWER TO THE MACHINE BEFORE SERVICING.

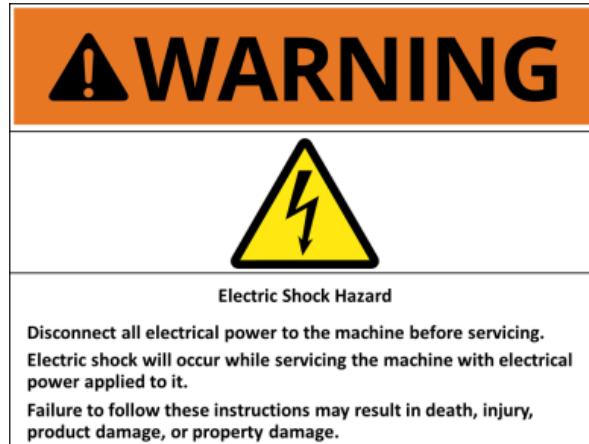

4.1 – Coin Hopper Maintenance

Removal of the Electronics and Opto Sensor Board

All the electronics and sensors are placed on one board located behind the exit door at the side of the hopper. Slide the yellow button to the opposite position and remove the exit door where the electronics are mounted. All dirt must be cleaned with a soft moistened cloth. Isopropyl Alcohol is recommended for cleaning excessively dirty exit windows. The red LED on the exit window board will begin flashing indicating a dirty opto-sensor.

Warning: Be careful when re-inserting the board back in the hopper not to damage the cable located at the back of the board!

Low Coin Contact Plates

Looking inside the hopper through the top opening locate the two brass plates at the bottom of the hopper. If they appear to be dull and/or dirty remove the right section of the hopper by removing the 6 screws on that side. Use a Scotch-Brite pad, or another item made with abrasive material, to scrub the oxidation and dirt off of the brass plates.

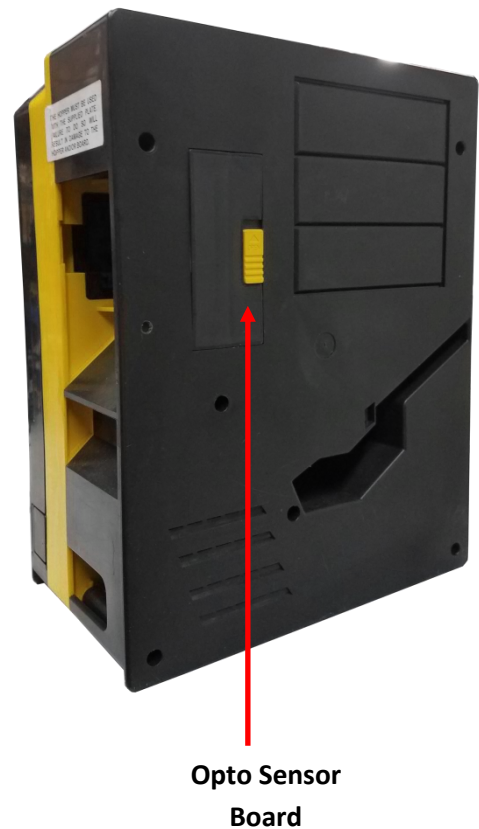

4.2 – Bill Validator Maintenance

Pyramid Acceptors Apex Model

The Apex Series bill acceptor is relatively maintenance free. An occasional cleaning is all that is needed to keep the acceptor in top operation. **Please Visit the “service” section of the pyramidacceptos.com website to view videos explaining how install, clean, program, and troubleshoot the Apex bill acceptor.**

To clean the acceptor:

- Remove power from the machine.
- If equipped with a stacker, unlatch the cassette by pushing in the top latch and lifting the cassette up and out.
- Unplug the I/O connector and/or power connector from the right side of the acceptor.
- Remove the Lower Transport by pushing in the latch located on the bottom of the acceptor at the rear. Gently pull the Lower Transport out of the assembly.
- Clean the bill path using a soft cloth or towel. Do not use any cleaners other than a 50/50 mixture of water and isopropyl alcohol.

NOTE: Pay particular attention to the gray oval pieces of plastic in the lower and upper transport area. They must be cleaned well for proper operation.

Do not use any oils or silicon spray on the acceptor!

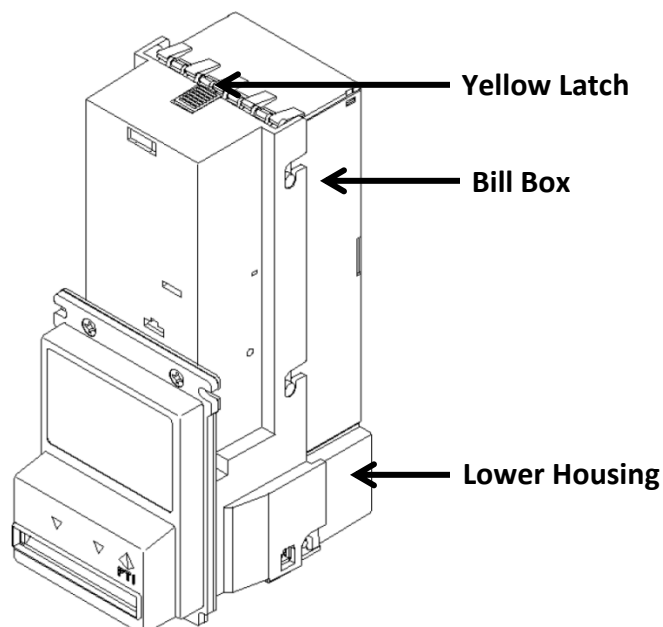

Crane Payment Innovations (CPI) AE 2600 Series

You can clean the bill acceptor while it is still mounted in the machine

1. Remove power from the machine.
2. Unlatch the magazine by pushing the yellow latch (located on the top of the unit) toward the front of the unit.
3. Unhook and remove the magazine by holding the latch and lifting up and then back on the magazine.
4. Unlatch the LED Housing by lifting up on the metal bar (located below the Status LED).
5. Remove the LED Housing by holding the metal bar and pulling back on the LED Housing.
6. Clean the bill path with a soft cloth. You may use mild, non-abrasive, non-petroleum based cleaners if sprayed on the cloth.

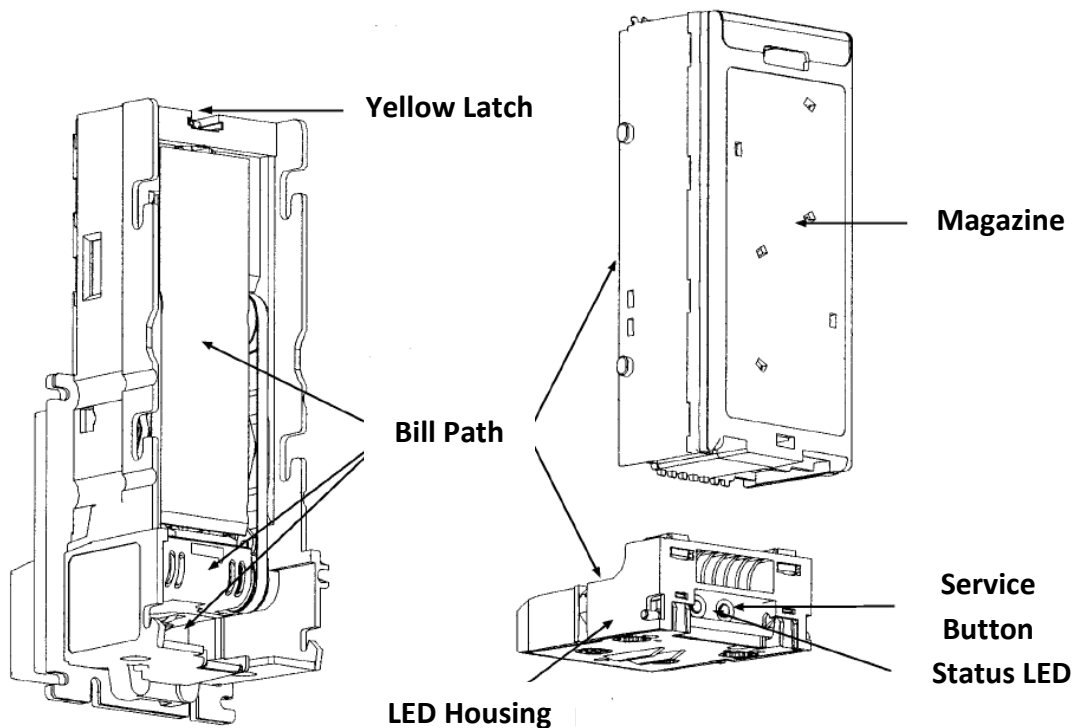

Astro Systems GBA ST1-C

Cleaning the Validator Note Path

Equipment Required

- Cotton swab or lint-free cloth.
- Cleaning solution - a mix of water and up to 50% Iso-Propyl Alcohol (IPA) is recommended.
- **DO NOT** use more than 50% IPA. **NEVER** use solvent-based cleaning agents, such as Amberclens, pure alcohol, petrol, methylated spirit or white spirit on this product as the unit will be severely damaged.

Anti-Static precautions should always be observed when cleaning the GBA ST1C unit.

1. Ensure the power supply to the GBA ST1C unit is switched OFF.
2. Remove the Cassette.
3. Lift up the purple Access Latch on the back of the Bottom Sensor Assembly, and gently slide the module out of the Channel Assembly.
4. Pick off and discard any large items of debris from the note path of the Bottom Sensor Assembly. Repeat for the other side of the note path (on the drive belt assembly).
5. Using the cotton swab, or lint-free cloth, wetted with cleaning solution and applying light force only, carefully clean all sensor windows in both halves (upper and lower) of the note path. If a sensor window has become badly scratched do not attempt to polish it, contact your local regional office for further advice.
6. Continue with the swab, or lint-free cloth, to clean the rest of the note path, including sprung rollers.
7. Visible parts of belts can be cleaned by wiping with a cleaning solution-soaked cotton swab or wipe. It is not possible to clean the whole belt surface without removing the belts from the unit.
8. Use an additional swab or cloth to dry the cleaned area, if required.
9. Slide the clean Bottom Sensor Assembly back into the Channel, ensuring that the Access Latch clips securely into the Channel.
10. Re-fit the Cassette.
11. The supply to the unit can now be switched ON.

Clearing a Note Jam

1. Ensure the power supply to the GBA ST1C unit is switched OFF.
2. Remove the Cassette.
3. Lift up the purple Access Latch on the back of the Bottom Sensor Assembly, and gently slide the module out of the Channel Assembly.
4. Clear the jammed note(s) from the note path.
5. Re-assemble unit and switch the power supply back ON.



4.3 – Parts List

Note: If your model is not shown please contact the American Changer Service Department for part information.

AC500

Cabinet Dimensions

10.5" W x 26" H x 13" D
26.7cm W x 66cm H x 33cm D

Machine Dry Weight

75 lbs
34 kg

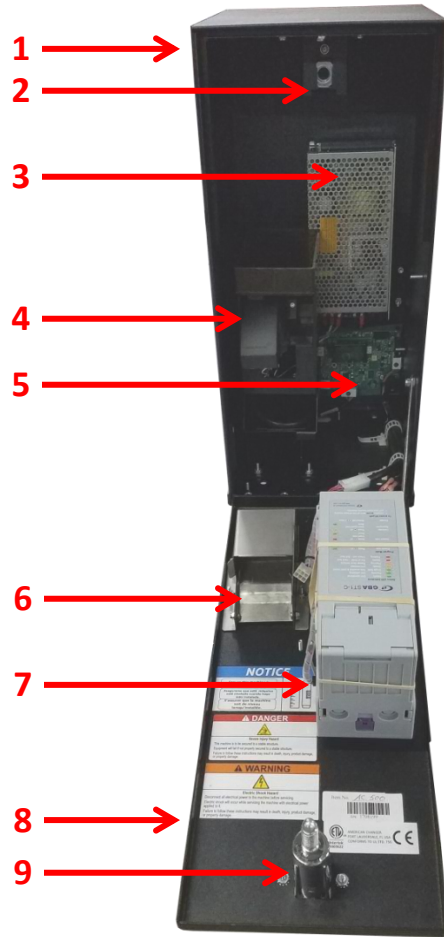

Number	American Changer Part #	Description
1	AC5010	AC500 Cabinet
2	AC1000-LB	Lock Bracket
3	AC8062-Flex	Meanwell RS-150-24 24VDC 6.5A Power Supply
4	AC5040.4	Compact Hopper
5	AC1065.3	Universal Board
6	AC5400-CC	Coin Cup for AC500
7	Bill Validator	Various Models Available. Contact American Changer for part number. ST1C model shown in above picture.
8	AC500-DR	Door for AC500
9	AC5080-QS	Screw in T-Handle

AC1000 and AC1001 – AC1000 is sold without a bill validator. Optional coin acceptor is not shown.

Cabinet Dimensions

8.5" W x 26" H x 13" D
21.6cm W x 66cm H x 33cm D

Machine Dry Weight

58 lbs
26.3 kg

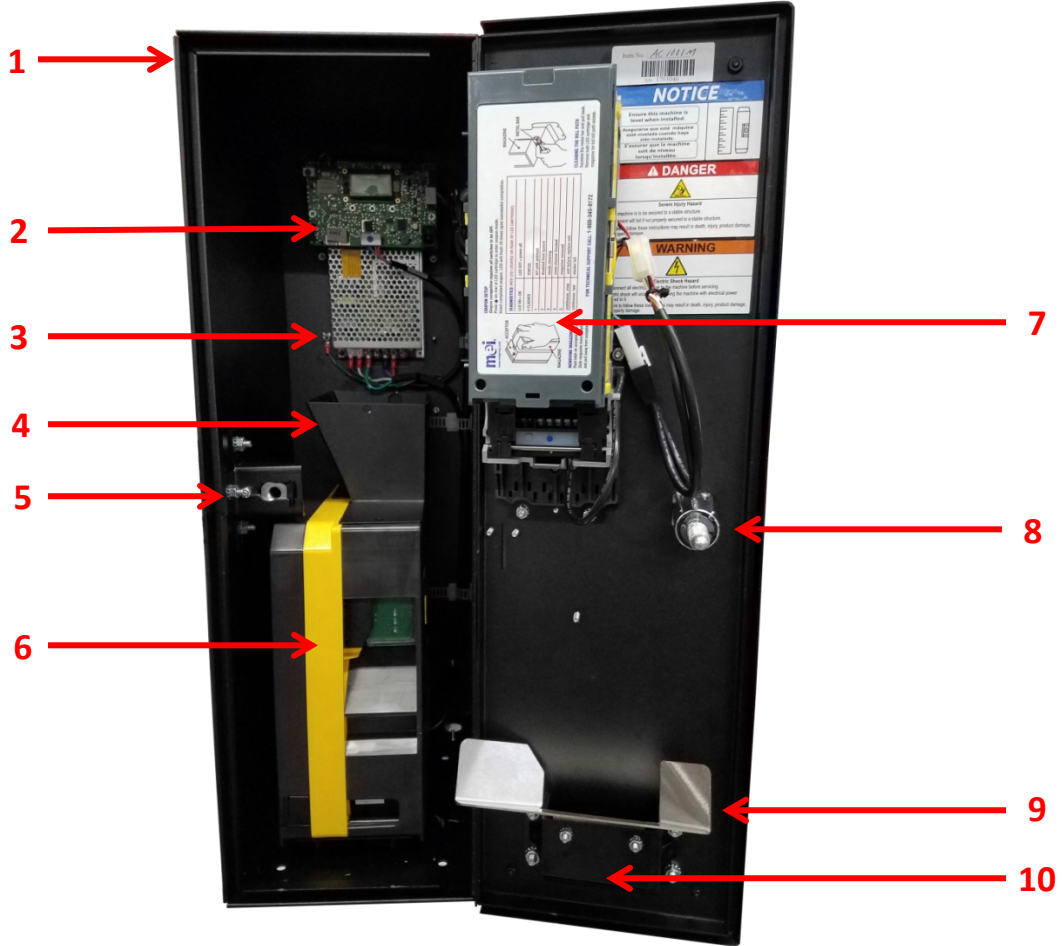

Number	American Changer Part #	Description
1	AC1010	AC1000-AC1001 Cabinet
2	AC1065.3	Universal Board
3	AC8062-Flex	Meanwell RS-150-24 24VDC 6.5A Power Supply
4	AC1000-HE	Hopper Extension
5	AC1000-LB	Lock Bracket
6	AC1047-SUZO	Evolution Hopper with 12 Pin Female Connector
7	Bill Validator	Various Models Available. Contact American Changer for part number. AE2600 Series shown in above picture.
8	AC5080-QS	Screw in T-Handle
9	AC5400-UCC	Coin Cup Chute
10	AC1013-P	Coin Cup

AC1002 – Optional coin acceptor is not shown.

Cabinet Dimensions

10.5" W x 26" H x 13" D
26.7cm W x 66cm H x 33cm D

Machine Dry Weight

75 lbs
34 kg

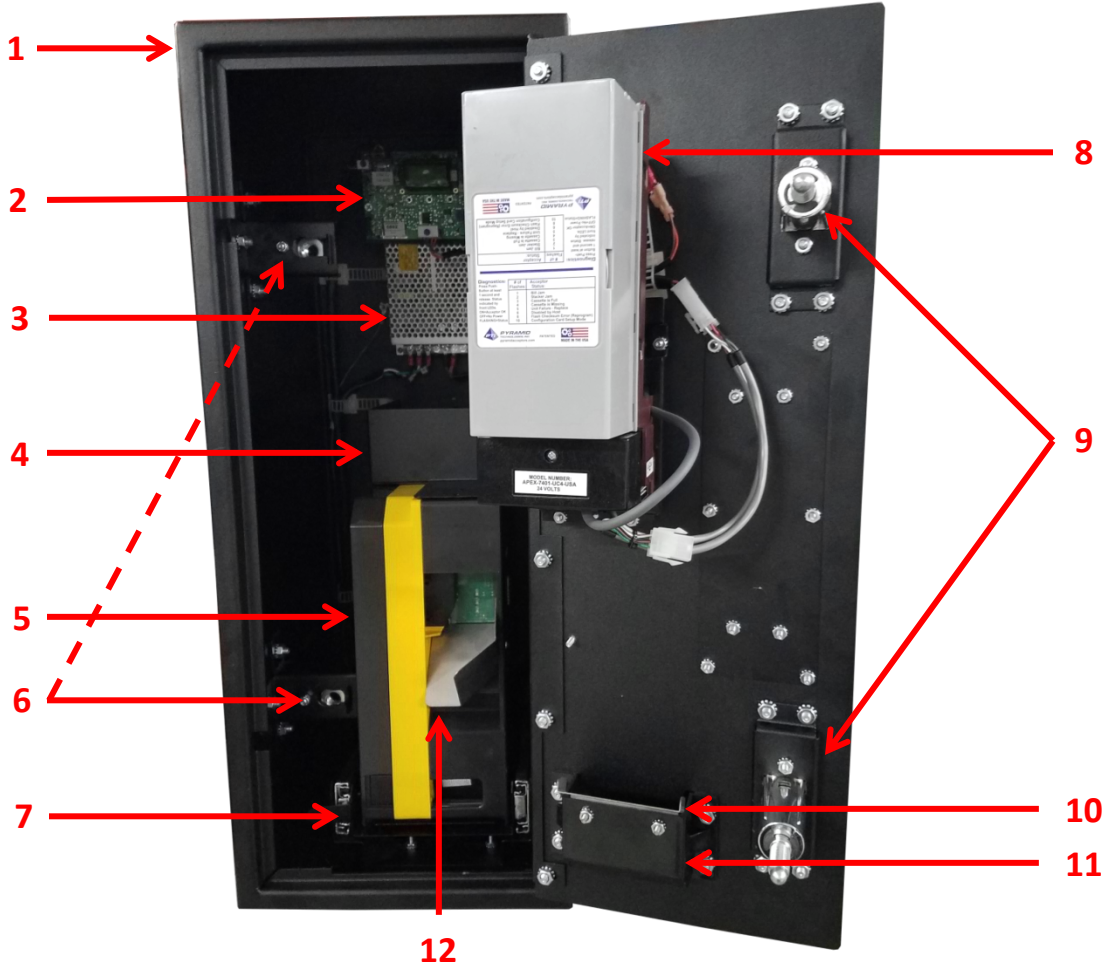

Number	American Changer Part #	Description
1	AC1012	AC1002 Cabinet
2	AC1065.3	Universal Board
3	AC8062-Flex	Meanwell RS-150-24 24VDC 6.5A Power Supply
4	AC1002-HEXTASSY	Hopper Extension
5	AC1047-SUZO	Evolution Hopper with 12 Pin Female Connector
6	AC2002-LB	Lock Bracket (AC1002 has 2 lock brackets)
7	AC1002-HM	Hopper Mount Assembly
8	Bill Validator	Various Models Available. Contact American Changer for part number. Apex model shown in above picture.
9	AC5080-QS	Screw in T-Handle (AC1002 has 2 T-Handles)
10	AC1002-CC	Coin Cup Chute
11	AC1013-P	Coin Cup
12	AC401-HC	Right Hopper Coin Chute

AC1005 – Stainless steel front and optional coin acceptor are not shown. Stainless steel front part number is AC1011.1 (Lexan front is not included). Items #9 and #10 are not shown. Refer to AC1001 picture on page 25.

Cabinet Dimensions	8.5" W x 26" H x 13" D 21.6cm W x 66cm H x 33cm D	Machine Dry Weight	58 lbs 26.3 kg
Stainless Steel Face Plate Dimensions	12.5" W x 30" H 32cm W x 76cm H	Stainless Steel Face Plate Weight	20 lbs 9 kg

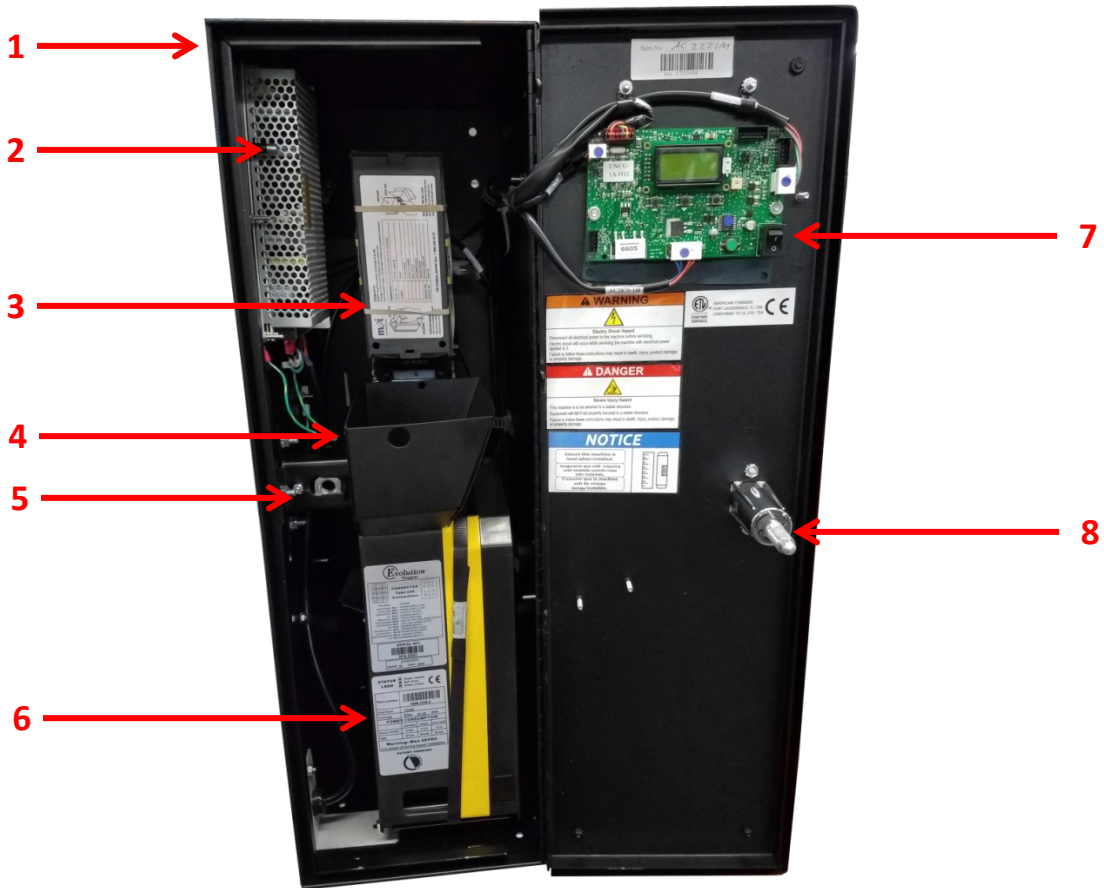

Number	American Changer Part #	Description
1	AC1011	AC1005 Cabinet
2	AC8062-Flex	Meanwell RS-150-24 24VDC 6.5A Power Supply
3	Bill Validator	Various Models Available. Contact American Changer for part number. AE2600 Series shown in above picture.
4	AC1000-HE	Hopper Extension
5	AC1000-LB	Lock Bracket
6	AC1047-SUZO	Evolution Hopper with 12 Pin Female Connector
7	AC1065.3	Universal Board
8	AC5080-QS	Screw in T-Handle
9	AC5400-UCC	Coin Cup Chute
10	AC1013-P	Coin Cup

AC2000 and AC2001 – AC2000 is sold without a bill validator. Optional coin acceptor is not shown.

Cabinet Dimensions

13.5" W x 26" H x 13" D
34.3cm W x 66cm H x 33cm D

Machine Dry Weight

91 lbs
41.3 kg



Number	American Changer Part #	Description
1	AC2010	AC2000-AC2001 Cabinet
2	AC1065.3	Universal Board
3	AC8062-Flex	Meanwell RS-150-24 24VDC 6.5A Power Supply
4	AC1002-HEXTASSY	Hopper Extension
5	AC1000-LB	Lock Bracket
6	AC1047-SUZO	Evolution Hopper with 12 Pin Female Connector
7	Bill Validator	Various Models Available. Contact American Changer for part number. Apex 7000 Series shown in above picture.
8	AC5080-QS	Screw in T-Handle
9	AC5400-UCC	Coin Cup Chute
10	AC1013-P	Coin Cup

AC2002 – AC2002 picture used below. AC2002.1 has 1 bill validator instead of 2.

Cabinet Dimensions

15.5" W x 26" H x 13.5" D
39.4cm W x 66cm H x 34.3cm D

Machine Dry Weight

98 lbs
44.5 kg

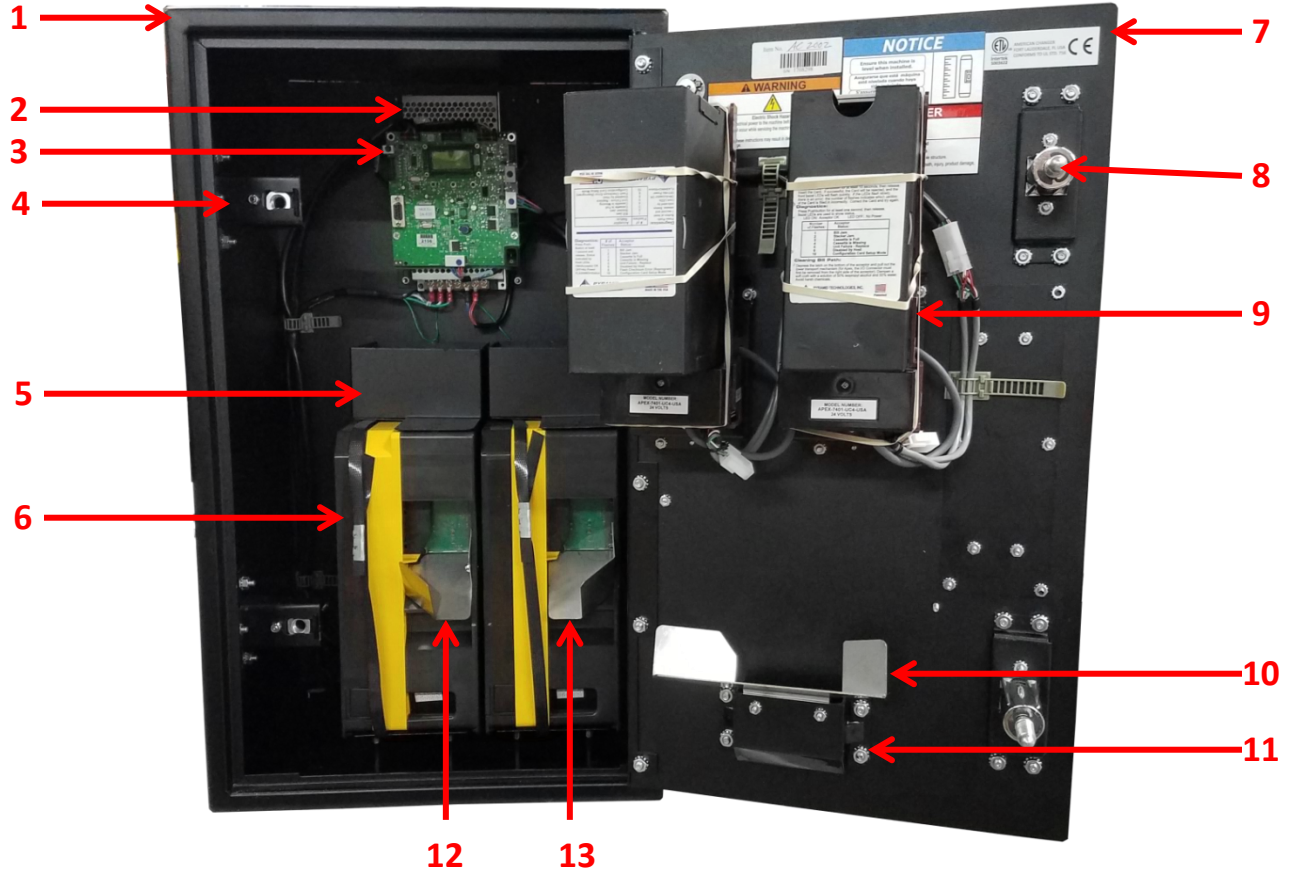

Number	American Changer Part #	Description
1	AC2012	AC2002 Cabinet
2	AC8062-Flex	Meanwell RS-150-24 24VDC 6.5A Power Supply
3	AC1065.3	Universal Board
4	AC2002-LB	Lock Bracket (AC2002 has 2 lock brackets)
5	AC1002-HEXTASSY	Hopper Extension
6	AC1047-SUZO	Evolution Hopper with 12 Pin Female Connector
7	AC2002-DR	AC2002 Door
8	AC5080-QS	Screw in T-Handle (AC2002 has 2 T-Handles)
9	Bill Validator	Various Models Available. Contact American Changer for part number. Apex model shown in above picture.
10	AC5400-UCC	Coin Cup Chute
11	AC1013-P	Coin Cup
12	AC401-HCL	Left Hopper Coin Chute
13	AC401-HC	Right Hopper Coin Chute

AC2005 – Stainless steel front and optional coin acceptor are not shown. Stainless steel front part number is AC2011.1 (Lexan front is not included). Items #9 and #10 are not shown. Refer to AC2001 picture on page 25.

Cabinet Dimensions	13.5" W x 26" H x 13.5" D 34.3cm W x 66cm H x 34.3cm D	Machine Dry Weight	91 lbs 41.3 kg
Stainless Steel Face Plate Dimensions	17.5" W x 30" H 44.5cm W x 76cm H	Stainless Steel Face Plate Weight	24 lbs 11 kg



Number	American Changer Part #	Description
1	AC2011	AC2005 Cabinet
2	AC1065.3	Universal Board
3	AC8062-Flex	Meanwell RS-150-24 24VDC 6.5A Power Supply
4	Bill Validator	Various Models Available. Contact American Changer for part number. AE2600 Series shown in above picture.
5	AC1000-HE	Hopper Extension
6	AC1000-LB	Lock Bracket
7	AC1047-SUZO	Evolution Hopper with 12 Pin Female Connector
8	AC5080-QS	Screw in T-Handle
9	AC5400-UCC	Coin Cup Chute
10	AC1013-P	Coin Cup

AC2009 – The hopper extension is not shown in the below picture. The part # for the hopper extension is AC2009-HP.

Cabinet Dimensions

13.5" W x 26" H x 13" D
34.3cm W x 66cm H x 33cm D

Machine Dry Weight

98 lbs
44.5 kg

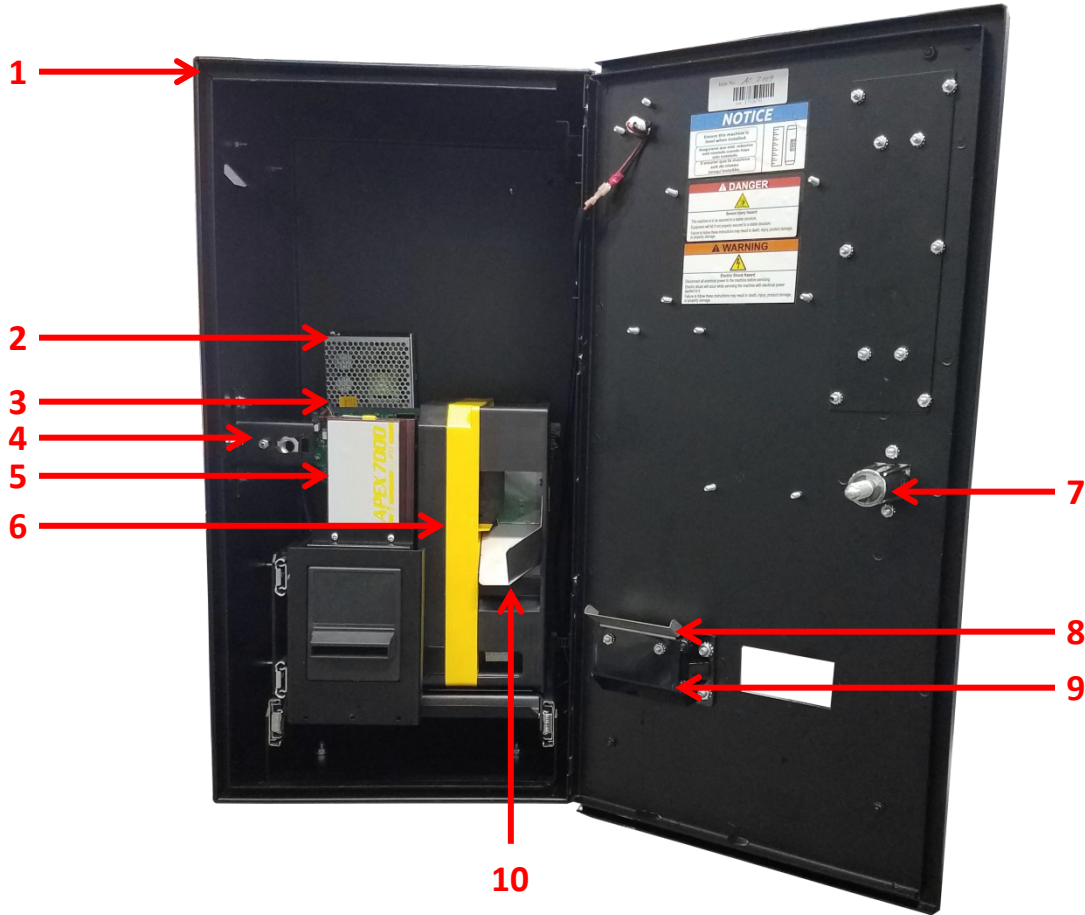

Number	American Changer Part #	Description
1	AC2010.2	AC2009 Cabinet
2	AC8062-Flex	Meanwell RS-150-24 24VDC 6.5A Power Supply
3	AC1065.3	Universal Board
4	AC2002-LB	Lock Bracket
5	Bill Validator	Various Models Available. Contact American Changer for part number. AE2600 Series shown in above picture.
6	AC1047-SUZO	Evolution Hopper with 12 Pin Female Connector
7	AC5080-QS	Screw in T-Handle
8	AC1002-CC	Coin Cup Chute
9	AC1013-P	Coin Cup
10	AC401-HC	Right Hopper Coin Chute

AC2221 – Stainless steel front and optional coin acceptor are not shown. Stainless steel front part number is AC1011.2 (Lexan front is not included). Items #9 and #10 are not shown. Refer to AC2001 picture on page 25.

Cabinet Dimensions	17.5" W x 26" H x 13.5" D 43.8cm W x 66cm H x 34.3cm D	Machine Dry Weight	116 lbs 52.6 kg
Stainless Steel Face Plate Dimensions	21" W x 30" H 53.3cm W x 76.2cm H	Stainless Steel Face Plate Weight	25 lbs 11.3 kg

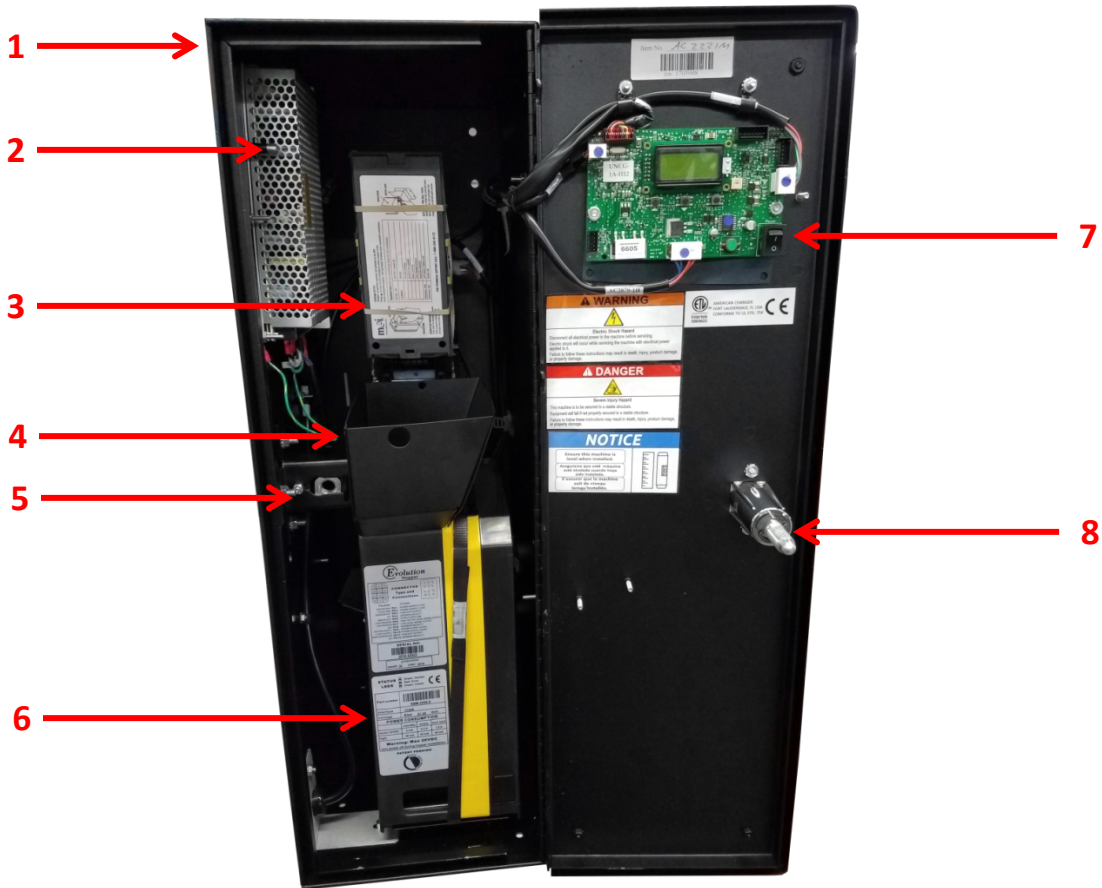

Number	American Changer Part #	Description
1	AC1011	AC1005 Cabinet
2	AC8062-Flex	Meanwell RS-150-24 24VDC 6.5A Power Supply
3	Bill Validator	Various Models Available. Contact American Changer for part number. AE2600 Series shown in above picture.
4	AC1000-HE	Hopper Extension
5	AC1000-LB	Lock Bracket
6	AC1047-SUZO	Evolution Hopper with 12 Pin Female Connector
7	AC1065.3	Universal Board
8	AC5080-QS	Screw in T-Handle
9	AC5400-UCC	Coin Cup Chute
10	AC1013-P	Coin Cup

AC2225 – Stainless steel front and optional coin acceptor are not shown. Stainless steel front part number is AC2011.2 (Lexan front is not included).

Cabinet Dimensions	19.25" W x 26" H x 14" D 48.9cm W x 66cm H x 35.6cm D	Machine Dry Weight	130 lbs 59 kg
Stainless Steel Face Plate Dimensions	23" W x 32" H 58.4cm W x 81.3cm H	Stainless Steel Face Plate Weight	32 lbs 14.5 kg

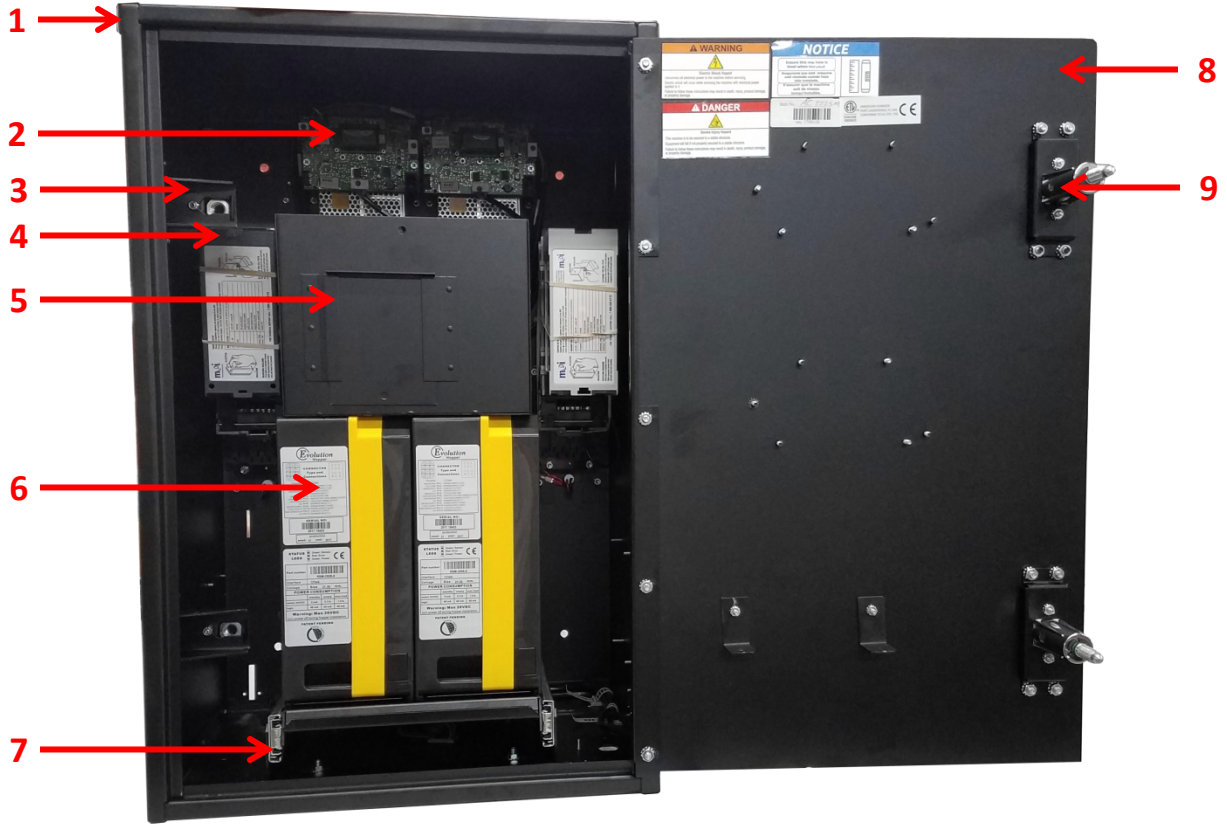

Number	American Changer Part #	Description
1	AC2013	AC2225 Cabinet
2	AC1065.3	Universal Board
3	AC2002-LB	Lock Bracket
4	Bill Validator	Various Models Available. Contact American Changer for part number. AE2600 Series shown in above picture.
5	AC1042.3	AC2225 Hopper Extension
6	AC1047-SUZO	Evolution Hopper with 12 Pin Female Connector
7	AC2225-HM	Hopper Mount Assembly
8	AC2225-DR	AC2225 Door
9	AC5080-QS	Screw in T-Handle

AC8004 – Optional coin acceptor not shown.

Cabinet Dimensions 10.5" W x 26" H x 13" D
 26.7cm W x 66cm H x 33cm D

Machine Dry Weight 75 lbs
 34 kg



Number	American Changer Part #	Description
1	AC8004-10	AC8004 Cabinet
2	AC8000-LB	Lock Bracket
3	AC8062-Flex	Meanwell RS-150-24 24VDC 6.5A Power Supply
4	AC1065.3	Universal Board
5	Bill Validator	Various Models Available. Contact American Changer for part number. Apex 7000 Series shown in above picture.
6	AC1047-SUZO	Evolution Hopper with 12 Pin Female Connector
7	AC2225-HM	Hopper Mount Assembly
8	AC8004-DR	AC8004 Door
9	AC8080	Screw-In Locking Mechanism Assembly
10	AC5400-UCC	Coin Cup Chute
11	AC1013-SS	Coin Cup

AC8009

Cabinet Dimensions

10.5" W x 26" H x 13" D
26.7cm W x 66cm H x 33cm D

Machine Dry Weight

75 lbs
34 kg

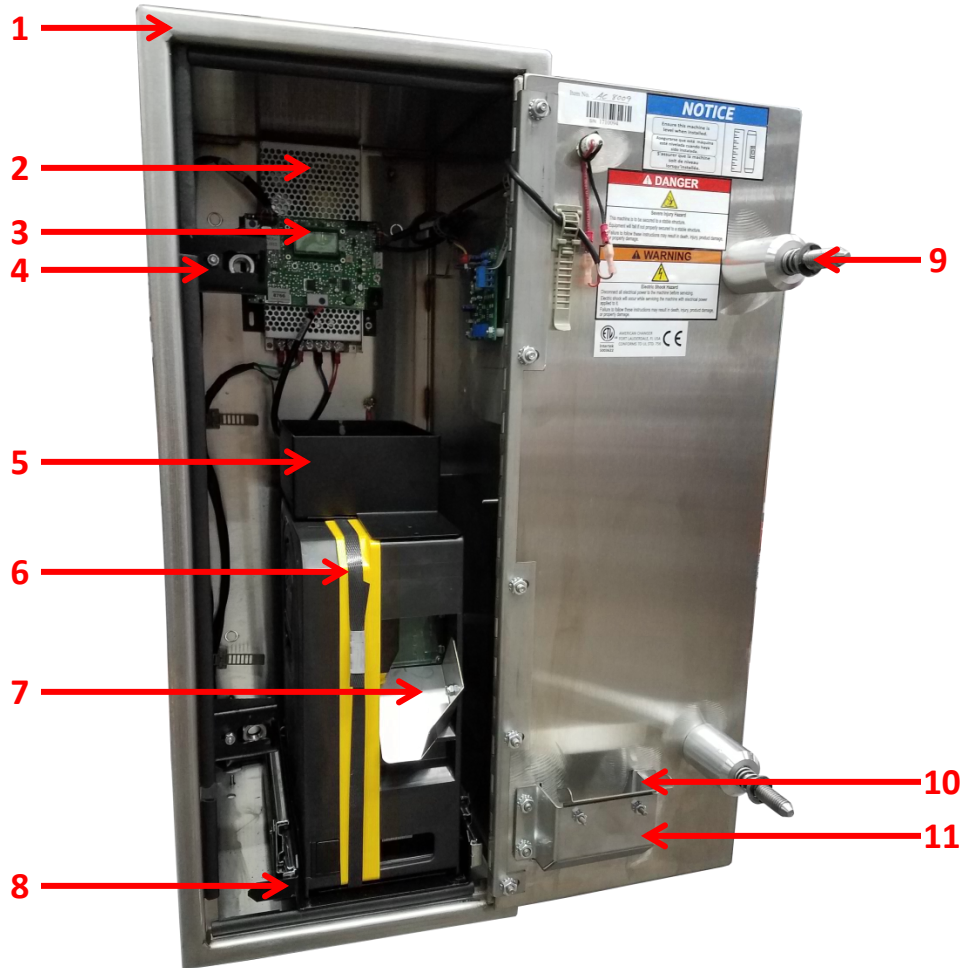

Number	American Changer Part #	Description
1	AC8009-10	AC8009 Cabinet
2	AC8062-Flex	Meanwell RS-150-24 24VDC 6.5A Power Supply
3	AC1065.3	Universal Board
4	AC2002-LB	Lock Bracket (AC8009 has 2 lock brackets)
5	AC1002-HEXTASSY	Hopper Extension
6	AC1047-SUZO	Evolution Hopper with 12 Pin Female Connector
7	AC401-HC	Right Hopper Coin Chute
8	AC1002-HM	Hopper Mount Assembly
9	AC8080	Screw-In Locking Mechanism Assembly (AC8009 has 2)
10	AC1002-CC	Coin Cup Chute
11	AC1013-SS	Coin Cup

BC1400A

Cabinet Dimensions

12" W x 38.5" H x 18.5" D
30.48cm W x 97.79cm H x
46.99cm D

Machine Dry Weight

171 lbs
77.5 kg

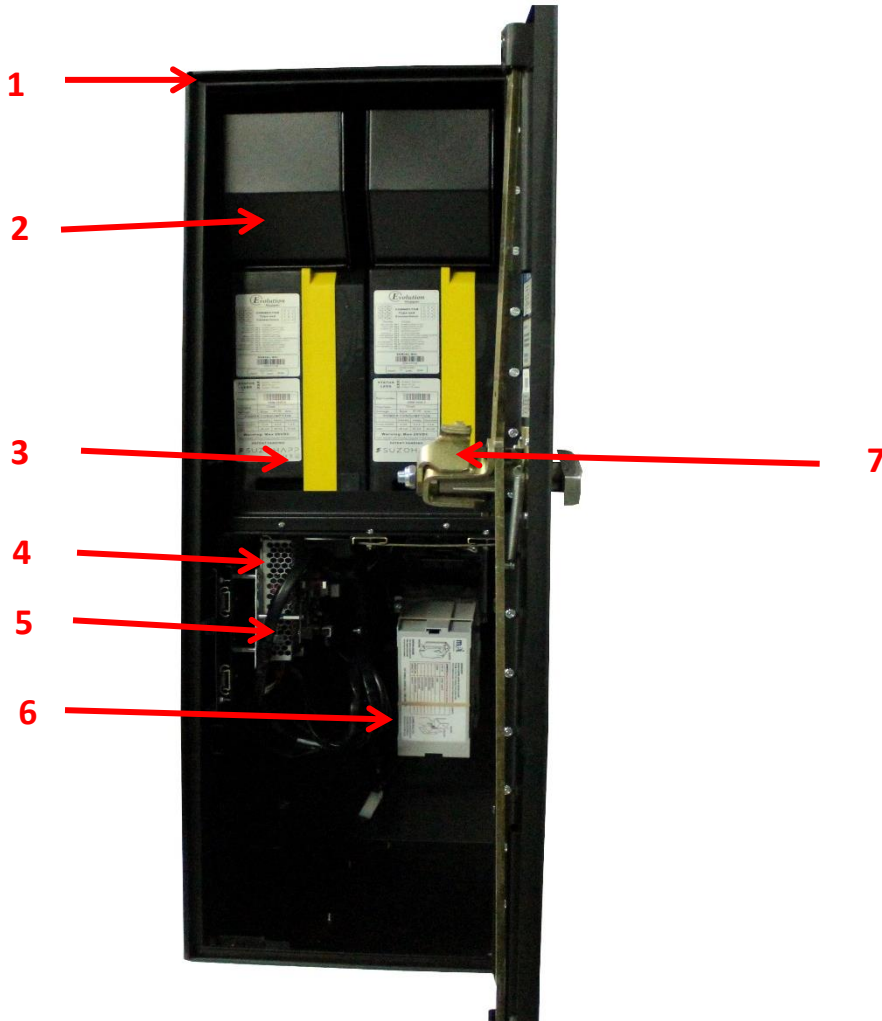

Number	American Changer Part #	Description
1	BC1400	BC1400 Cabinet
2	45065901	Hopper Extension
3	AC1047-SUZO	Evolution Hopper with 12 Pin Female Connector
4	AC8062-Flex	Meanwell RS-150-24 24VDC 6.5A Power Supply
5	AC1065.3	Universal Board
6	Bill Validator	Various Models Available. Contact American Changer for part number. AE2600 Series shown in above picture.
7	35027708	Lock assembly

4.4 – Warranty Terms and Conditions

LIMITED WARRANTY AND EXCLUSIVE REMEDIES – The goods delivered hereunder are subject to the terms of American Changer Corporation’s (Seller or Seller’s) Limited Warranty provided with the deliverable, or if there is no such warranty, the terms set forth herein. In the event of any inconsistency between the written warranty provided with deliverable, and the description of the warranty set forth herein, the written warranty shall govern.

Seller warrants that its new products and parts are free from defects in material or workmanship in normal use for one year from the date of shipment by Seller. In addition, this warranty will be extended for a second year for Bill Validators. Refurbished parts carry a six-month warranty from date of shipment by Seller.

Seller will furnish without charge, F.O.B. Fort Lauderdale, repair or replacement of any defective part qualifying for repair and/or replacement under the terms of its warranty, within one year of the date of delivery. Any transportation, diagnosis calls, or similar expenses are not included. The warranty for any replacement part will only apply to the remainder of the warranty period.

This warranty may not be changed or modified without the consent of an Executive Officer of Seller.

To make a claim under this warranty, Buyer must call Seller’s Service Department and provide the model number and serial number of the goods. If the goods were purchased from a reseller, Buyer must provide the name, address and telephone number of the reseller. Seller reserves the right to request proof that the reseller purchased the goods from the Seller.

Seller’s Limited Warranty does not cover damage caused by: (I) shipping or physical abuse; (II), misapplication or misuse including improper installation, startup, storage, or failure to comply with any instructions for use set forth in the owner’s manual supplied with the goods, or use, storage or operation of the goods in a manner that fails to comply with all applicable laws, rules and regulations, including, without limitation, any local labeling requirements or labeling required under California’s Safe Drinking Water and Toxic Enforcement Act of 1986 (also known as “Proposition 65”) and its implementing regulations; (III) failure to perform necessary maintenance and cleaning in accordance with the owner’s manual provided with the goods or comply with all applicable law or regulation, all applicable labeling requirements (IV) power surges, improper electrical supply and/or lightning strike; (V) operation, use or storage of goods in weather or outdoor conditions which do not comply with the guidelines set forth in the owner’s manual supplied with the goods; and (VI) fires, floods, or other casualty or Acts of God outside of Seller’s control.

This warranty is void if: (I) repairs and/or replacement are performed by anyone other than Seller or a qualified repair technician; (II) the goods were purchased in a used condition or not in the original packaging; (III) the goods have any defects or damage due to any alterations, or damage caused by improper electrical supply, shipping and handling, fire, flood, misuse, vandalism, or any other condition or event outside of Seller’s control, or the goods are used , stored or operated in a manner that fails to comply with any applicable law, rule, or regulation,

including, without limitation any local labeling requirements or labeling required under California’s Safe Drinking Water and Toxic Enforcement Act of 1986 (also known as “Proposition 65”) and its implementing regulations; (IV) the failure to clean and maintain the product in accordance with the owner’s manual supplied with the goods or comply with all applicable law and regulations and any applicable labeling requirements; (V) the goods are operated, used, or stored in weather or outdoor conditions which do not comply with the guidelines set forth in the owner’s manual.

The owner is responsible for: (I) using the goods supplied by the Seller in accordance with the installation, start-up, use, storage, inspection, and service requirements, and all other instructions set forth in the owner's manual supplied with the goods; (II) providing normal cleaning and maintenance in accordance with the owner's manual supplied with the goods; (III) operating, using, and storing the goods in accordance with the owner's manual supplied with the goods and in compliance with all applicable laws, rules, or regulations, including any local labeling requirements or labeling required under California's Safe Drinking Water and Toxic Enforcement Act of 1986 (also known as "Proposition 65") and its implementing regulations; (IV) contacting American Changer during the warranty period to obtain a Return Material Authorization to make a claim under this warranty; (V) providing proof of purchase if requested, and if the goods were purchased from a reseller, the name, address, and telephone number of the reseller; (VI) providing any other information American Changer may reasonably request to confirm that the goods are eligible for repair/replacement under this warranty; (VII) paying for any repairs or replacement of parts outside the scope of this warranty; (VIII) paying any shipping costs.

ENTIRE WARRANTY

THIS WARRANTY CONSTITUTES THE EXCLUSIVE REMEDY OF THE PURCHASER AND IN LIEU OF ALL OTHER WARRANTIES, EXPRESS OR IMPLIED, INCLUDING, WITHOUT LIMITATION, ANY IMPLIED WARRANTY OF MERCHANTABILITY OR FITNESS FOR A PARTICULAR PURPOSE TO THE EXTENT PERMITTED BY LAW.

SELLER EXPRESSLY DISCLAIMS ALL LIABILITY ARISING OUT OF THE THEFT, MISAPPROPRIATION, OR MISUSE OF ANY PERSONAL FINANCIAL INFORMATION OF AN END USER OF THE GOODS, INCLUDING, BUT NOT LIMITED TO, CREDIT CARD AND/OR DEBIT CARD NUMBERS, PERSONAL IDENTIFICATION NUMBERS, PERSONAL PASSWORDS OR PASSCODES, OR OTHER SIMILAR PERSONAL INFORMATION OF THE USER OF THE GOODS.

IN NO EVENT SHALL AMERICAN CHANGER BE LIABLE TO BUYER UNDER THIS WARRANTY FOR AN AMOUNT WHICH EXCEEDS THE PURCHASE PRICE OF THE GOODS.

IN NO EVENT SHALL AMERICAN CHANGER BE LIABLE FOR ANY INCIDENTAL OR CONSEQUENTIAL DAMAGES OR LOST PROFITS, OR FOR DAMAGES ARISING OUT OF BUYER'S INSTALLATION, OPERATION OR STORAGE OF THE GOODS IN A MANNER THAT FAILS TO COMPLY WITH ANY APPLICABLE LAW, RULE, OR REGULATION, INCLUDING ANY LABELING LAW, RULE OR REGULATION INCLUDING, WITHOUT LIMITATION, CALIFORNIA'S SAFE DRINKING WATER AND TOXIC ENFORCEMENT ACT OF 1986 (ALSO KNOWN AS "PROPOSITION 65") AND ITS IMPLEMENTING REGULATIONS.

SELLER EXPRESSLY DISCLAIMS ALL GUARANTEES AND/OR WARRANTIES, EXPRESS OR IMPLIED, INCLUDING WARRANTIES OF MERCHANTABILITY AND FITNESS FOR A PARTICULAR PURPOSE, OR USEFUL LIFE.

LIMITATIONS OF DAMAGES – Seller's liability for any loss or damage arising out of, or resulting from, any breach or default by Seller in connection with the sale of goods hereunder, shall not exceed the purchase price thereof, regardless of whether such liability arises in contract, tort (including, without limitation, negligence or strict liability) or otherwise, and in no event shall Seller be liable for incidental or consequential damages of any kind or for lost profits.

Buyer is solely responsible for installing, storing, operating and maintaining the goods delivered hereunder in compliance with all applicable laws, rules and regulations, and any local labeling requirements or labeling required under California's Safe Drinking Water and Toxic Enforcement Act of 1986 (also known as "Proposition 65") and its implementing regulations. In no event shall Seller be liable for Buyer's failure to install, store, operate or maintain the goods in compliance with any applicable law, rule or regulation.

WARRANTY FORM

The Warranty Form must be filled out completely and mailed to:

American Changer Corp.

1400 NW 65th Place

Ft. Lauderdale, FL 33309

Attention: Extended Warranty Department

Machine Information

Machine Model & Serial Number: _____

Validator Serial Number: _____

Validator Serial Number: _____

Hopper Serial Number: _____

Hopper Serial Number: _____

Logic Board Serial Number: _____

Coin Mechanism Serial Number: _____

Your Name: _____

Company Name: _____

Billing Address: _____

Billing Address: _____

City: _____

State and Zip Code: _____

Phone Number: _____

Email Address: _____

Note: The purpose of this form is to enter your information in our customer database. This information will not be shared with anyone outside of American Changer Corp. It will be used to inform you of equipment upgrades.