

MICHAEL PHELPS

Chilly



GOAT<sup>™</sup>  
COLD TUBS

 BY MASTER SPAS<sup>®</sup>

VALARIS

---

OWNER'S MANUAL  
& LIMITED WARRANTY

# Welcome to the Chilly GOAT community!

## MICHAEL PHELPS CHILLY GOAT™ COLD TUB BY MASTER SPAS OWNER’S MANUAL

Thank you for choosing your new Michael Phelps Chilly GOAT Cold Tub by Master Spas. For How-to Videos and helpful tips on operating and maintaining your cold tub, please visit [ChillyGOATtubs.com/pages/how-to-videos](http://ChillyGOATtubs.com/pages/how-to-videos).

Please read the entire Owner's Manual before installing and using your cold tub. The goal of this manual is to provide you with safety and operational information plus some tips that will help you enjoy your cold tub to its fullest. At the time of print, this manual is accurate in its information. Master Spas reserves the right to change or improve its product without prior notice.

### REGISTER YOUR CHILLY GOAT

Please be sure to register your cold tub so we can efficiently assist with any questions you may have. Until your cold tub has been registered Master Spas will not have record of your ownership. To register your cold tub, go to [masterspas.com/registration](http://masterspas.com/registration).

### SERIAL NUMBER LOCATION

The serial number for your cold tub is located near the filter area, on the cold tub system pack, or on the listing plate on the cold tub frame behind the front skirt panel. It begins with "T", followed by 6 digits. For example, T241234.

### RECORD OF OWNERSHIP

Name \_\_\_\_\_

Address \_\_\_\_\_

City \_\_\_\_\_ State \_\_\_\_\_ Zip \_\_\_\_\_

Phone \_\_\_\_\_ Date Purchased \_\_\_\_\_

Model \_\_\_\_\_ Serial \_\_\_\_\_

Dealer Name \_\_\_\_\_

Service Tech Rep \_\_\_\_\_

Scan the QR code to download  
digital owner's manual



# TABLE OF CONTENTS

<b>Safety Instructions</b> .....	1-5
<b>VGB Suction Safety &amp; Maintenance Instructions</b> .....	6
<b>Glossary of Chilly GOAT Terminology</b> .....	7-8
<b>Water Chemistry Terms You Should Know</b> .....	9-10
<b>Why Are Chemicals Important in a Chilly GOAT</b> .....	10
<b>Water Maintenance</b> .....	11-13
Recommended Ranges .....	11
Start-Up .....	11-12
Schedule .....	12-13
Troubleshooting Guide .....	13
<b>Regular Maintenance Procedures</b> .....	14-20
<b>Chilly GOAT Troubleshooting Guide</b> .....	20-22
<b>Winterizing &amp; Storing Your Chilly GOAT</b> .....	22-23
<b>Model Specifications</b> .....	23
<b>Installation Instructions</b> .....	23-28
Site Preparation/General Guidelines .....	24
Electrical Requirements .....	25-26
Initial Chilly GOAT Setup .....	26-28
<b>Operating Instructions</b> .....	28-39
Chilly GOAT Controls - Clim8zone Heat Pump Controls .....	28-33
Chilly GOAT Controls - TP500 .....	33-39
<b>Limited Warranty</b> .....	39-41
<b>Chilly GOAT Care &amp; Maintenance Record</b> .....	42-43

# SAFETY INSTRUCTIONS

## SAVE THESE INSTRUCTIONS

Included with your new Chilly GOAT™ is a safety sign. The sign is for you and your guest's protection and is suitable for outdoor use in wet locations. The sign should be placed in a location visible to all users of the Chilly GOAT.

Please take time to point out the physical location of the safety sign and the importance of the safety precautions displayed on the safety sign to all of your guests. Remember, your safety and the safety of anyone who enjoys the use of your Chilly GOAT is our utmost concern.

The sign should be mounted with screws or another type of permanent fastener. Additional or replacement signs can be obtained from your dealer or direct from the factory.

## INTRODUCTION

It's time to relax and chill! You now have your very own Michael Phelps Chilly GOAT by Master Spas. By fully understanding the operation of each of the features of your new Master Spa, you will be assured of many years of hassle-free, hot and cold water therapy and fun.

Your safety is of paramount importance to the Master Spas family. We urge you to carefully read, understand, and follow all information in this user manual before installing and using the Chilly GOAT. These warnings, instructions, and safety guidelines address some common risks of water recreation, but they cannot cover all risks and dangers in all cases. Always use caution, common sense, and good judgment when enjoying any water activity. Retain this information for future use.

Through reading and totally understanding the important information in your owner's manual, you will realize that you now own the Michael Phelps Chilly GOAT Valaris!



Safety graphical symbol  
ISO 7010, M002: Refer to  
instruction manual/booklet



## IMPORTANT SAFETY INSTRUCTIONS

This Chilly GOAT is not intended for public/commercial use.

When installing and using this electrical equipment, basic safety precautions should be observed including the following:

## READ AND FOLLOW ALL INSTRUCTIONS

**WARNING:** To reduce the risk of injury, do not permit children to use this product unless they are closely supervised at all times.

A wire conductor is provided on this unit to connect a minimum 10AWG (5.26mm<sup>2</sup>) solid copper conductor between this unit and any metal equipment, metal enclosures of electrical equipment, metal water pipe, or conduit within 5 feet (1.5m) of the unit.

(For cord-connected/convertible units)

**DANGER:** Risk of injury.

- a) Replace damaged cord immediately.
- b) Do not bury cord.
- c) Connect to a grounded, grounding type receptacle only.

(For units intended for indoor use only)

**WARNING:** For indoor use only. This unit is not intended for outdoor use.

(For units intended for outdoor use only)

**WARNING:** For outdoor use only. This unit is not intended for indoor use.

(For units with GFCI)

**WARNING:** This product is provided with a ground-fault circuit interrupter located on the front panel of selected swim spas and on the power cord of 120 volt convertible spas. The

GFCI must be tested before each use. With the product operating, open the service door. When the product stops operating, this merely indicates that the door is equipped with an electrical interlock. Next, push the test button on the GFCI and close the service door. The product should not operate. Now open the service door, push the reset button on the GFCI and close the service door. The product should now operate normally. When the product fails to operate in this manner, there is a ground current flowing indicating the possibility of an electric shock. Disconnect the power until the fault has been identified and corrected.

**DANGER:** Risk of Accidental Drowning. Extreme caution must be exercised to prevent unauthorized access by children. To avoid accidents, ensure that children cannot use this Chilly GOAT unless they are supervised at all times.

**DANGER:** Risk of Injury. The suction fittings in this Chilly GOAT are sized to match the specific water flow created by the pump. Should the need arise to replace the suction fittings or the pump, be sure that the flow rates are compatible. Never operate Chilly GOAT if the suction fittings are broken or missing. Never replace a suction fitting with one rated less than the flow rate marked on the original suction fitting.

**DANGER:** Risk of Electric Shock. Install at least 5 feet (1.5m) from all metal surfaces. As an alternative, a Chilly GOAT may be installed within 5 feet of metal surfaces if each metal surface is permanently connected by a minimum 10AWG (5.26mm<sup>2</sup>) solid copper conductor to the wire connector on the terminal box that is provided for this purpose. Be sure to review and comply with any overruling local or national applicable regulations.

**DANGER:** Risk of Electric Shock. Do not permit any electric appliance, such as a light, telephone, radio, or television, within 5 feet (1.5 m) of a Chilly GOAT.

**WARNING:** To reduce the risk of injury:

a) The water in a Chilly GOAT should never exceed 104 °F (40 °C). Water temperatures between 100 °F (38 °C) and 104 °F (40 °C) are considered safe for a healthy adult. Lower water temperatures are recommended for young children and when Chilly GOAT use exceeds 10 minutes. Persons with any medical

condition should seek medical advice before using a Chilly GOAT.

- b) Since excessive water temperatures have a high potential for causing fetal damage during the early months of pregnancy, pregnant or possibly pregnant women should limit Chilly GOAT water temperatures to 100 °F (38 °C) and duration of use and should also seek medical advice.
- c) Before entering a Chilly GOAT, the user should measure the water temperature with an accurate thermometer since the tolerance of water temperature-regulating devices varies.
- d) The use of alcohol, drugs, or medication before or during Chilly GOAT use may lead to unconsciousness with the possibility of drowning.
- e) Obese persons and persons with a history of heart disease, low or high blood pressure, circulatory system problems, or diabetes should consult a physician before using a Chilly GOAT.
- f) Persons using medication should consult a physician before using a Chilly GOAT since some medication may induce drowsiness while other medication may affect heart rate, blood pressure, and circulation.

(For Chilly GOATs with a gas heater)

**WARNING:** Risk of Suffocation. This Chilly GOAT is equipped with a gas heater and is intended for outdoor use only unless proper ventilation can be provided for an indoor installation.

## SAVE THESE INSTRUCTIONS

### HYPERTHERMIA

Hyperthermia occurs when the internal temperature of the body reaches a level several degrees above the normal body temperature of 98.6°F (37 °C). Prolonged immersion in hot water may induce hyperthermia.

### THE SYMPTOMS OF HYPERTHERMIA INCLUDE:

- Dizziness
- Lethargy
- Fainting
- Increase in Internal Body Temperature
- Drowsiness

# NODIVING

**DANGER: DIVING MAY RESULT IN SERIOUS INJURY OR DEATH.**



## THE EFFECTS OF HYPERTHERMIA INCLUDE:

- Unawareness of Impending Hazard
- Failure to Perceive Heat
- Failure to Recognize the Need to Exit Chilly GOAT
- Physical Inability to Exit Chilly GOAT
- Fetal Damage in Pregnant Women
- Unconsciousness Resulting in a Danger of Drowning

## HYPOTHERMIA

Hypothermia occurs when the internal temperature of the body reached a level several degrees below the normal body temperature of 98° F (37° C). Prolonged immersion in cold water may induce hypothermia.

## THE SYMPTOMS OF HYPOTHERMIA INCLUDE:

- Shivering
- Slurred speech or mumbling
- Slow shallow breathing
- Weak pulse
- Clumsiness
- Drowsiness
- Confusion
- Unconsciousness
- Bright red, cold skin (in infants)

## THE EFFECTS OF HYPOTHERMIA INCLUDE:

- Failure of the nervous system
- Respiratory system and heart
- Failure to recognize the need to exit the Chilly GOAT™ cold tub
- Unawareness of impending hazard
- Fetal damage in pregnant women
- Physical inability to exit the Chilly GOAT
- Unconsciousness resulting in the danger of drowning

**WARNING:** The use of alcohol, drugs, or medication can greatly increase the risk of hyperthermia.

**DANGER:** To reduce the risk of injury to persons, do not remove the suction grate. Suction through drains and skimmers is

powerful when the jets in the Chilly GOAT are in use. Damaged covers can be hazardous to small children and adults with long hair. Should any part of the body be drawn into these fittings, turn off the Chilly GOAT immediately. As a precaution, long hair should not be allowed to float in the Chilly GOAT.



**EN 17125: Do not put finger in massage jet**

**WARNING:** Install the Chilly GOAT so that water can be easily drained out of the compartment containing electrical components so as not to damage equipment. When installing the Chilly GOAT make sure to allow for an adequate drainage system to deal with any overflow water. Please allow for at least 3 feet of clearance around the perimeter of the Chilly GOAT to provide enough room to access for servicing. Contact your local dealer for their specific requirements.

**WARNING:** The Chilly GOAT should be covered with an approved locking cover when not in use, to prevent unauthorized entry and injuries.

**WARNING:** People with infections, sores or the like should not use the Chilly GOAT. Warm and hot water temperatures may allow the growth of infectious bacteria if not properly disinfected.

**CAUTION:** Safe temperatures for swimming or aquatic exercise is around 80°F (26.7°C).

**CAUTION:** Risk of Electrical Shock. Do not leave audio compartment open. Audio CD controls are not to be operated while inside the Chilly GOAT.

**CAUTION:** Replace components only with identical components.

**WARNING:** Risk of Electric Shock. Do not connect any auxiliary components (for example, additional speakers, headphones, additional audio/video components etc.) to the system. These units are not provided with an outdoor antenna.

Do not service this product yourself as opening or removing covers may expose you to dangerous voltage or other hazards. Refer all servicing to qualified service personnel. If the power supply cord(s) are damaged, water is entering the speaker, audio compartment,

or any other component in the electrical equipment compartment area, the protective shield is showing signs of deterioration, or there are signs of other potentially hazardous damage to the unit, turn off the circuit breaker from the wall and refer servicing to qualified personnel.

The unit should be subjected to periodic routine maintenance once every quarter to make sure that it is operating properly.

**DANGER:** Risk of Electric Shock. A green colored terminal or a terminal marked G, GR, Ground, Grounding or the symbol shown in Figure 14.1 of UL 1563 is located inside the supply terminal box or compartment. To reduce the risk of electric shock, this terminal must be connected to the grounding means provided in the electric supply service panel with a continuous copper wire equivalent in size to the circuit conductors supplying this equipment.

At least two lugs marked "Bonding Lugs" are provided on the external surface or on the inside of the supply terminal box or compartment. To reduce the risk of electric shock, connect the local common bonding grid in the area of the Chilly GOAT to these terminals with an insulated or bare copper conductor not smaller than 10AWG.

All field installed metal components such as rails, ladders, drains, or other similar hardware within 10 feet (3m) of the Chilly GOAT shall be bonded to the equipment grounding bus with copper conductors not smaller than 10AWG.

## SAVE THESE INSTRUCTIONS

**WARNING:** CHILDREN SHOULD NOT USE COLD TUBS OR HOT TUBS WITHOUT ADULT SUPERVISION.

**AVERTISSEMENT:** NE PAS LAISSER LES ENFANTS UTILISER UNE CUVE DE RELAXATION SANS SURVEILLANCE.

**WARNING:** DO NOT USE COLD TUBS OR HOT TUBS UNLESS ALL SUCTION GUARDS ARE INSTALLED TO PREVENT BODY AND HAIR ENTRAPMENT.

**AVERTISSEMENT:** POUR ÉVITER QUE LES CHEUX OU UNE PARTIE DU CORPS PUISSENT ÊTRE ASPIRES, NE PAS UTILISER UNE CUVE DE RELAXATION SI LES GRILLES DE PRISE D'ASPIRATION NE SONT PAS TOUTES EN PLACE.

**WARNING:** PEOPLE USING MEDICATIONS AND/OR HAVING AN ADVERSE MEDICAL HISTORY SHOULD CONSULT A PHYSICIAN BEFORE USING A COLD TUB OR HOT TUB.

**AVERTISSEMENT:** LES PERSONNES QUI PRENNENT DES MÉDICAMENTS OU ONT DES PROBLÈMES DE SANTÉ DEVRAIENT CONSULTER UN MÉDECIN AVANT D'UTILISER UNE CUVE DE RELAXATION.

**WARNING:** PEOPLE WITH INFECTIOUS DISEASES SHOULD NOT USE A COLD TUB OR HOT TUB.

**AVERTISSEMENT:** LES PERSONNES ATTEINTES DE MALADIES INFECTIEUSES NE DEVRAIENT PAS UTILISER UNE CUVE DE RELAXATION.

**WARNING:** TO AVOID INJURY EXERCISE CARE WHEN ENTERING OR EXITING THE COLD TUB OR HOT TUB.

**AVERTISSEMENT:** POUR ÉVITER DES BLESSURES, USER DE PRUDENCE EN ENTRANT DANS UNE CUVE DE RELAXATION ET EN SORTANT.

**WARNING:** DO NOT USE DRUGS OR ALCOHOL BEFORE OR DURING THE USE OF A COLD TUB OR HOT TUB TO AVOID UNCONSCIOUSNESS AND POSSIBLE DROWNING.

**AVERTISSEMENT:** POUR ÉVITER L'ÉVANOUISSEMENT ET LA NOYADE ÉVENTUELLE, NE PRENDE NI DROGUE NI ALCOOL AVANT D'UTILISER UNE CUVE DE RELAXATION NI QUAND ON S'Y TROUVE.

**WARNING:** PREGNANT OR POSSIBLY PREGNANT WOMEN SHOULD CONSULT A PHYSICIAN BEFORE USING A COLD TUB OR HOT TUB.

**AVERTISSEMENT:** LES FEMMES ENCEINTES, QUE LEUR GROSSESSE SOIT CONFIRMÉE OU NON, DEVRAIENT CONSULTER UN MÉDECIN AVANT D'UTILISER UNE CUVE DE RELAXATION.

**WARNING:** WATER TEMPERATURE IN EXCESS OF 38 °C MAY BE INJURIOUS TO YOUR HEALTH.

**AVERTISSEMENT:** IL PEUT ÊTRE DANGEREUX POUR LA SANTÉ DE SE PLONGER DANS DE L'EAU À PLUS DE 38 °C.

**WARNING:** BEFORE ENTERING THE CHILLY GOAT™ OR HOT TUB MEASURE THE WATER TEMPERATURE WITH AN ACCURATE THERMOMETER.

# **NODIVING**

**DANGER: DIVING MAY RESULT  
IN SERIOUS INJURY OR DEATH.**

**AVERTISSEMENT:** AVANT D'UTILISER  
UNE CUVE DE RELAXATION MESURER LA  
TEMPÉRATURE DE L'EAU À L'AIDE D'UN  
THERMOMÈTRE PRÉCIS.

**WARNING:** DO NOT USE A COLD TUB  
OR HOT TUB IMMEDIATELY FOLLOWING  
STRENUOUS EXERCISE.

**AVERTISSEMENT:** NE PAS UTILISER UNE CUVE  
DE RELAXATION IMMÉDIATEMENT APRÈS UN  
EXERCISE FATIGANT.

**WARNING:** PROLONGED IMMERSION IN A  
COLD TUB OR HOT TUB MAY BE INJUROUS  
TO YOUR HEALTH.

**AVERTISSEMENT:** L'UTILISATION PROLONGÉE  
D'UNE CUVE DE RELAXATION PEUT ÊTRE  
DANGEREUSE POUR LA SANTÉ.

**WARNING:** DO NOT PERMIT ELECTRIC  
APPLIANCES (SUCH AS LIGHT, TELEPHONE,  
RADIO, OR TELEVISION) WITHIN 1.5 M OF THIS  
COLD TUB OR HOT TUB.

**AVERTISSEMENT:** NE PAS PLACER D'APPAREIL  
ÉLECTRIQUE (LUMINAIRE, TÉLÉPHONE, RADIO,  
TÉLÉVISEUR, ETC) À MOINS DE 1.5 M DE CETTE  
CUVE DE RELAXATION.

**CAUTION:** MAINTAIN WATER CHEMISTRY  
IN ACCORDANCE WITH MANUFACTURER'S  
INSTRUCTION.

**ATTENTION:** LA TENEUR DE L'EAU EN  
MATIÈRES DISSOUTES DOIT ÊTRE CONFORME  
AUX DIRECTIVES DU FABRICANT.

**WARNING:** THE USE OF ALCOHOL OR DRUGS  
CAN GREATLY INCREASE THE RISK OF FATAL  
HYPERTHERMIA IN HOT TUBS AND  
COLD TUBS.

**AVERTISSEMENT:** LA CONSOMMATION  
D'ALCOOL OU DE DROGUE AUGMENTE  
CONSIDÉRABLEMENT LES RISQUES  
D'HYPERTHERMIE MORTELLE DANS UNE CUVE  
DE RELAXATION.

For Chilly GOATs relying on a specific means of  
egress, such means shall not be removed when  
the Chilly GOAT is in use.

**DANGER:** This appliance is not intended for use  
by persons (including children) with reduced  
physical, sensory or mental capabilities, or  
lack of experience and knowledge, unless they  
have been given supervision or instruction  
concerning use of the appliance by a person  
responsible for their safety.

Children should be supervised to ensure that  
they do not play with the appliance.



**Safety graphical symbol ISO  
20712-1, WSM002: Keep children  
under supervision in the aquatic  
environment**

**DANGER:** Risk of Accidental Drowning  
(especially children under 5 years). Caution  
shall be exercised to prevent unauthorized  
access to the Chilly GOAT by children. This  
can be reached by an adult supervisor securing  
the means of access or installing a safety  
protection device to the Chilly GOAT. To avoid  
accidents during Chilly GOAT use, ensure that  
children are kept under constant  
adult supervision.

Avoid putting the head under water at  
all times.

Avoid swallowing Chilly GOAT water.

**DANGER:** No Diving.



**Safety graphical symbol ISO  
20712-1, WSP005: No Diving**



# VGB SUCTION SAFETY & MAINTENANCE INSTRUCTIONS

## VGB 2008:

### WARNING

- ⚠ Read and follow all instructions in this manual and on the suction fitting. Failure to follow instructions can cause severe injury and/or death.
- ⚠ Failure to remove pressure test plugs and/or plugs used in winterization of the Chilly GOAT™ from the suction outlets can result in an increased potential for suction entrapment.
- ⚠ Suction outlet components have a finite life. The cover/grate should be inspected frequently and replaced at least every seven years, or if found to be damaged, broken, cracked, missing, or not securely attached.
- ⚠ If the fitting is missing or broken, replace with a fitting of equivalent rating or higher. Use of a lower rated suction fitting could result in entrapment of the body which could result in serious injury including drowning.
- ⚠ Do not use or operate Chilly GOAT if this suction fitting is missing, broken or not secured per instructions. The suction fitting is intended to prevent entrapment of the body. Use of the Chilly GOAT with a missing, broken or improperly secured suction grate may result in serious personal injury including drowning.
- ⚠ When the Chilly GOAT is in operation, suction is created at this fitting. Users of the Chilly GOAT must be instructed not to come in contact with this fitting in such a way as to block its orifice. If a user of the Chilly GOAT blocks this fitting with his/her body, serious personal injury or drowning may occur.

## IMPORTANT SAFETY INSTRUCTIONS



### WARNING: SUCTION ENTRAPMENT HAZARD

Suction in suction outlets and/or suction outlet covers which are damaged, broken, cracked, missing, or unsecured can cause severe injury and/or

death due to the following entrapment hazards:

**Hair Entrapment:** Hair can become entangled in suction outlet cover.

**Limb Entrapment:** A limb inserted into an opening of a suction outlet sump/fitting or suction outlet cover that is damaged, broken, cracked, missing, or not securely attached can result in a mechanical bind or swelling of the limb.

**Body Suction Entrapment:** A negative pressure applied to a large portion of the body or limbs can result in an entrapment.

**Evisceration/Disembowelment Entrapment:** A negative pressure applied directly to the intestines through an unprotected suction outlet sump or suction outlet cover which is damaged, broken, cracked, missing, or unsecured can result in evisceration/disembowelment entrapment.

**Mechanical Entrapment:** There is potential for jewelry, swimsuit, hair decorations, finger, toe, or knuckle to be caught in an opening of a suction outlet cover resulting in mechanical entrapment.

## TO REDUCE THE RISK OF ENTRAPMENT HAZARDS:

- Never use a Chilly GOAT if any suction outlet component is damaged, broken, cracked, missing, or not securely attached.
- Replace damaged, broken, cracked, missing, or not securely attached suction outlet components immediately.
- It is recommended that suction components be inspected at least monthly.
- Replace the suction within 7 years from the installation date. Contact your dealer or local service center for quoting and scheduling this required maintenance. This is a mandated regulation and is not part of nor covered by the Chilly GOAT warranty.

**NOTE:** Always review entire safety and maintenance information before beginning maintenance. Contact Master Spas for Suction Installation information for complete suction assembly replacement.

# GLOSSARY OF TERMINOLOGY

Your new Chilly GOAT™ Valaris combines features from both hot tub and cold tub therapy. The hot tub portion

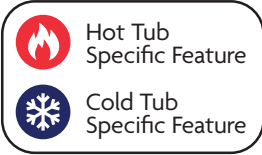

features a variety of jets that mix air and water creating a vigorous massage. The cold tub portion features circulation jets to keep the water moving providing the best possible cold water therapy. Here are some terms and definitions to help you get acquainted with your new Chilly GOAT Valaris.

## 1. THERAPY JETS 🔥

Therapy jets are located throughout the seats of the Chilly GOAT to offer a variety of therapy combinations.

## 2. AIR CONTROL VALVE

These valves are located around the top of your Chilly GOAT. You may increase or decrease the force of your jets by opening or closing the air control valves. When not in use the air controls should be kept in the closed position as the air being introduced into the water can tend to cool the water and increase the dissipation rate of sanitizer levels.



AIR CONTROL VALVE

## 3. TOPSIDE CONTROL PANEL 🔥

You may safely control the hot tub functions from inside or outside your Chilly GOAT using the Topside Control Panel. This panel is used to control the water temperature, pumps, LED lights, automatic filtration cycles and other advanced functions. The digital display will give you a constant temperature readout and will notify you in case of certain malfunctions. Several user programmable functions are also available.

## 4. ACCESS PANELS

These are the skirt panels located around all four sides of the Chilly GOAT. All of the skirt panels are removable should service be required. Master Spas recommends at least 3 feet of access be provided around the Chilly GOAT with 6' of open space for the side containing the heat pump ventilation,

panel "C".

## 5. EQUIPMENT ACCESS PANEL

There are 2 skirting panels with equipment access. The front panel is listed as panel "A." This will allow access to the therapy pump. The right side panel "D," will house the main electrical hookup as well as the cold tub equipment.

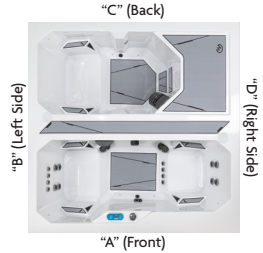

VALARIS DOWNSHOT

## 6. SPA CONTROL SYSTEM

The control systems primary function is to house and control the pumps and functions of the hot tub half. It also houses and supplies power to the cold tub half.



SPA CONTROL SYSTEM

## 7. SPA HEATER 🔥

This is an electric heater housed in a stainless steel tube. It is thermostatically controlled and equipped with high-limit temperature safety shut-off sensors.

## 8. SLICE VALVES

These valves are used by service personnel to shut off water to the heating system (heater, therapy pump, and heat pump) so that the Chilly GOAT water does not need to be drained if the Chilly GOAT requires service to the systems.

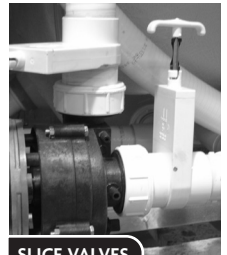

SLICE VALVES

**NOTE:** Slice valves must be completely open during normal operations.

## 9. THERAPY PUMP 🔥

This produces water flow through the main jets in the Chilly GOAT. This pump operates on a single high speed setting for 15 minutes at a time. High speed provides maximum jet action.



THERAPY PUMP

The therapy pump is controlled by the "Jets" button on the Topside Control Panel.

**10. CIRCULATION PUMP** 🔥 ❄️

This small, efficient pump can run up to 24 hours per day for efficient filtration and provides flow for the heat pump and spa heater operation to cool or heat the water.

**11. PUMP UNION** 🔥

This connects the plumbing and pump together. These are used to help relieve possible pump air locks or for service personnel to easily service the pumps.

**12. HEATER UNION** 🔥

These connect the spa heater to the plumbing and are used by service personnel to easily service the heater.



**13. HEAT PUMP** ❄️

This device provides heating and cooling capabilities to cool or heat the water to the desired temperature. The heat pump is sometimes referred to as the chiller.



**14. HEAT PUMP UNIONS** ❄️

Heat Pump Unions are used to connect the plumbing to the heat pump. These are used to help service personnel to easily service the heat pump.



**15. HEAT PUMP CONTROL PANEL**

This panel is located on the outside of the heat pump, which is located inside the cabinet and equipment area. Turning the

heat pump on or off, setting the water temperature and other functions can be controlled from this panel. The digital display will give you a temperature readout and will notify you in case of certain operational messages or errors.



**16. CIRCULATION JETS** ❄️

These jets provide the output for the circulation pump and flow for heat pump operation. The circulation jets also play a crucial role in providing a cold-water immersion experience. Water movement across the user prevents your body warmth from creating a warm water layer just over your skin, making the water feel warmer than it is. By circulating water over the user, it prevents that warmer water layer from developing, resulting in the user experiencing the full water set temperature.

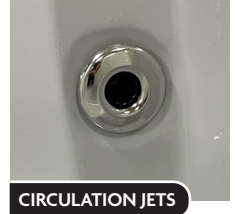

**17. SKIMMER FILTER HOUSING** 🔥 ❄️

This skimmer assembly provides water flow to the circulation pumps and houses the filter. The front skimmer faceplate portion can be removed, to allow access to the filter element.



**18. THERMOMETER** ❄️

This is a floating thermometer, provided in your luggage kit. It needs to be tethered within the cold tub unit and left floating in the water, so that users can check the water temperature before entering.



# WATER CHEMISTRY TERMS YOU SHOULD KNOW

Before jumping into Water Maintenance, here are some terms to help you.

- 1. PARTS PER MILLION (PPM):** This is a form of measurement used in most pool or spa chemical readings. Best described as any one million like items of equal size and make up, next to one unlike item, but of equal size. This would be one part per million.
- 2. TOTAL ALKALINITY (TA):** Measures substances in your water such as hydroxides, carbonates and bicarbonates. When at the proper levels, these elements keep your water from clouding and growing bacteria, as well as prevent the inner workings of your hot tub from deteriorating or forming scales. TA also helps to stabilize pH. The higher the TA level (as long as it is within the recommended range), the less likely the pH is to change. With low alkalinity, the pH will fluctuate and be harder to control. With high alkalinity, it becomes extremely difficult to change the pH.
- 3. PH OR POTENTIAL HYDROGEN:** This indicates the acidity or basicity of the water. The goal is to have a neutral, stable pH to prevent Chilly GOAT™ damage and unhealthy conditions. Low pH levels can corrode metals, etch or stain fiberglass or acrylic, cause unsanitary conditions that irritate the eyes or skin and destruct the total alkalinity of the water. High pH can cause cloudy water, eye or skin irritation, scale formation and poor chlorine or bromine efficiency. Note that the chemicals you are using to sanitize and clean your hot tub can also lower or raise the pH level in the water. Unfortunately, there are lots of variables to preventing high pH in your Chilly GOAT.
- 4. SHOCKING:** By shocking the water in your hot tub, you remove organic compounds from the water, kill bacteria, remove bromamines or chloramines and reactivate the bromides in the hot tub for cleaner water. You should shock your water once a week, after heavy bather use or any time free chlorine levels test lower than total chlorine levels. To do this, either add oxidizer/non-chlorine shock to burn off the chloramines or add extra chlorine to raise the chlorine level. Oxidizer/non-chlorine shock acts by releasing oxygen in the water, which serves a similar function as chlorine. An advantage to using this type of shock is that the water is safe to enter after 15 minutes of the application and excessive sanitizer (chlorine) levels do not occur. However, an oxidizer/non-chlorine shock doesn't disinfect the water for bacteria. If you use chlorine to shock, you must wait until the total chlorine reading is at a level safe to re-enter the water.
- 5. SEQUESTERING:** This can be defined as the ability to form a chemical complex which remains in solution, despite the presence of a precipitating agent (i.e. calcium and metals). If the minerals and metals in water are not sequestered, they can cause a reaction, turning the water brown, red, orange or green depending on the minerals and metals present in your water. It is important to add a sequestering agent when adding water to your spa and even on a regular basis (if bottle instructions recommend doing so). Common names for sequestering chemicals are: minquest, stain and scale control, metal-x, spa defender, spa metal gone, etc.
- 6. FILTRATION:** Filters are necessary to remove particles of dust, dirt, algae, etc., that are continuously entering the water. If the system is not operated long enough each day for the filter to do a proper job, this puts a burden on the chemicals, causing extra expense. Filtration time will depend on the water capacity, pump, filter size and, of course, bather load. Spare filter cartridges should be kept on hand to make it easy to frequently clean the cartridge without the need for a long shut down. This will also allow the cartridge to dry out between usages, which will increase the cartridge life span as much as twice. Replace the cartridge when the pleats begin to deteriorate. Cartridge cleaning should be done a minimum of once a month. More often with a heavy bather load. See *Cleaning Your Filter Elements* in the Regular Maintenance section.

- 7. SANITIZERS:** Germs and bacteria enter the water from the environment and the human body; a sanitizer keeps the water balanced and safe to use. Chlorine can be used as the sanitizer to create a healthy water environment.

**Chlorine:**

1. Only one type is approved for hot tub use. Sodium dichlor which is granular, fast dissolving and pH neutral chlorine.
2. Chlorine is an immediate sanitizer and will be added as needed to maintain free chlorine levels.

**NOTE:** Bromine is not recommended in the Chilly GOAT™ because it will cause premature deterioration to the Non-Slip mats.

- 8. TOTAL DISSOLVED SOLIDS (TDS):** Materials that have been dissolved by the water, i.e. like what happens when you put sugar in coffee or tea.
- 9. USEFUL LIFE OF WATER (IN DAYS):** Water should be drained at least once every 180 days. Useful life may vary by usage and bather load.
- 10. DEFOAMER:** A chemical used to temporarily reduce foaming. Causes of

foaming include body oils, cosmetics, lotions, surface cleaners, high pH or algae, as well as other organic materials. Low levels of calcium or sanitizer can also cause increased foaming. Note that you may need to physically remove the foam and/or drain all or part your water to remove or dilute the causes of the foam.

- 11. CALCIUM HARDNESS:** This measurement tells you how much magnesium and calcium are in your water. However, calcium hardness can react with all of the chemicals, bacteria, dirt and other substances that your water dissolves and get thrown out of balance. Just like the other elements, calcium levels must remain balanced and need to be monitored or you run the risk of metal deterioration, water foaming or clouding and scale formation at the surface of your water.
- 12. BIOFILM:** This is any group of microorganisms in which cells stick to each other and often these cells adhere to a surface (ie. Chilly GOAT™ plumbing and shell). Biofilm can occur over time during the use of your Chilly GOAT.

## WHY ARE CHEMICALS IMPORTANT IN A CHILLY GOAT

- 1. EVAPORATION:** As water evaporates, only pure water evaporates, leaving the salts, minerals, metals, and any unused chemicals behind. Adding water adds more salts, minerals, and metals. In time, the water can become saturated with these dissolved solids and can cause stains or scale to form on the walls of the Chilly GOAT or a scale build up inside the equipment. Colored or cloudy water and possible corrosion of plumbing and fittings may also occur.
- 2. HEAT:** Heat causes much quicker evaporation and also will cause minerals and metals to precipitate out of solution.
- 3. AIR:** Dust and other airborne contaminants are introduced into the Chilly GOAT.

- 4. ENVIRONMENT:** The environment surrounding the Chilly GOAT can also impact the water quality. Items such as pollen, grass, sand, dirt, lawn fertilizer, airborne dust, insects, leaves, and pets can all affect the water quality of the Chilly GOAT.
- 5. BATHERS:** As the Chilly GOAT is used, bathers introduce contaminants to the water. Increased bather load, length of use and frequency will increase the amounts of contaminants added in to the water.

**NOTE:** The maintenance routines set forth in this manual may need to be adjusted depending on bather load and how much the Chilly GOAT is being used.

# RECOMMENDED RANGES

## WATER CHEMISTRY GUIDE

Before treating your water, refer to the Model Specifications section of this manual for the correct gallons of your Chilly GOAT™, to ensure you are adding the correct amount of chemicals. The concentration of active

ingredients in your Chilly GOAT chemicals varies by manufacturer, so always consult chemical manufacturer's instructions. When adding chemicals, always spread them across the surface of the water while the pumps are running. See chart below for recommended ranges.

PARAMETER	VALUE <sup>A</sup>
Water Clarity	Clear view of the bottom
Color of Water	No color should be observed <sup>b</sup>
Total Alkalinity (TA)	80 - 150 ppm
pH Value <sup>c,d</sup>	7.2 - 7.6
Chlorine	2 - 4 ppm
Calcium Hardness	180- 250 ppm
When using alternative/additional disinfectants other appropriate parameters may be considered.	
<sup>a</sup> Consult national regulations and guidelines for any deviations.	
<sup>b</sup> Natural water sources may introduce water coloration.	
<sup>c</sup> Subject to the flocculant(s) used (if any).	
<sup>d</sup> When pH is greater than 7.5 the free active chlorine is less than 50%.	

**NOTE:** Recommended levels stated in this manual are based on industry standards for permanently installed and portable residential Chilly GOAT. Improper use of chemicals may result in unsanitary and unsafe water conditions as well as unwarranted discoloration, degradation, damage and other imperfections of the Chilly GOAT surface and components.

# START UP

**WATCH HOW-TO VIDEOS:** [ChillyGOATtubs.com/pages/how-to-videos](http://ChillyGOATtubs.com/pages/how-to-videos)

## START UP STEPS

1. Your Chilly GOAT should be filled with fresh tap water using a Pre-filter, which is included in your starting chemical kits. This Pre-filter will help remove many of the minerals existing in the water, which will make adjusting the water balance easier after a new fill. Never use more than 50% softened water when filling the Chilly GOAT.
2. During the initial filling of the unit, add a sequestering agent to each side to combat suspended minerals in the water. The agents are sold under many different names such as Mineral Clear or Metal Protect. Always follow the instructions listed on the bottle and allow water to circulate and filter for at least 30 minutes (or per bottle recommendations) before adding any other chemicals.

3. Test water for pH, total Alkalinity, and Calcium hardness. There are two different methods you can use to test your water.

**🔥 TESTING STRIPS:** The pads on these thin strips react by changing colors when you dip them in the hot tub water. To avoid faulty test results, use care when removing a testing strip from the packaging. Open the package and shake one strip out into your hand, avoiding contact if possible with the remaining strips. Seal the container immediately so the remaining strips are not exposed to moisture. Dip the test strip into the water and follow the instructions supplied with test strips as instructions may vary. Note the colors on your testing strip and compare these to the key found on the packaging to determine whether elements are neutral, too high or too low.

**NOTE:** Due to negative effects that cold water has on test strips; it is only recommended to use the liquid drop style testing kit on the cold portion your Chilly GOAT™.

 **TESTING KIT:** When using a testing kit, you will be examining an actual water sample from your hot tub/cold tub, rather than a strip. Be careful to follow the instructions on your kit, filling the container to the appropriate level and then dropping the instructed liquid into the container. Compare the new color of your water to the key provided with the kit to determine how to proceed. Depending on which kit you purchase, it can test for each one of these elements: total alkalinity, pH, chlorine, bromine and calcium hardness.

4. Adjust pH and total Alkalinity (TA) utilizing the directions on the chemical bottles. Wait 15 minutes, test and adjust if necessary.
5. It may be necessary to retest and add additional chemicals to get to the proper levels.

6. Add concentrated chlorinating granules (sodium Dichlor-s-triazinetriene) on initial start up to begin sanitizing the Chilly GOAT water, according to directions on chemical bottle. Bathers should not enter the Chilly GOAT until the chlorine drops to a safe level, refer to Water Chemistry Guide in this section. It is important not to add the chlorinating granules until the pH, alkalinity and calcium hardness have been adjusted to their proper levels.

**NOTE:** See the Model Specifications section of this manual for the correct gallons in each section of your Chilly GOAT, to ensure you are adding the correct amount of chemicals. When adding chlorine or non-chlorine shock/oxidizer always spread it across the water while the pumps are running. The concentration of active ingredients in Chilly GOAT chemicals varies by manufacturer.

**NOTE:** Always leave cover open for 15 minutes after adding chemicals to prevent the off gas from damaging your cover, spa pillows, stainless steel hardware and other critical parts

## WATER MAINTENANCE

# SCHEDULE

**WATCH HOW-TO VIDEOS:** [ChillyGOATtubs.com/pages/how-to-videos](http://ChillyGOATtubs.com/pages/how-to-videos)

### BEFORE EACH USE

Test the Chilly GOAT water for proper pH and sanitation levels. Adjust accordingly to the proper levels outlined in the Water Chemistry Guide, found in the Water Maintenance – Recommended Ranges section. Appropriate levels should be present before use of the Chilly GOAT. Bathers should not enter the Chilly GOAT if the chlorine levels are outside of the safe, recommended ranges.

### AFTER EACH USE

Test water and treat accordingly to maintain proper pH and free chlorine levels for continued sanitary conditions after use. The amount of people using the Chilly GOAT (and duration of use) will deplete chlorine levels and can cause free chlorine to test below total chlorine, resulting in a more frequent need to use an oxidizer/non-chlorine shock treatment.

### 3 TIMES A WEEK

Test the water using chemical test strips or test kit. Adjust sanitizer, pH and Alkalinity accordingly, following directions on the chemical manufacturer's bottle. If free chlorine level measures less than total chlorine level, additional non-chlorine shock/oxidizer treatment is necessary.

**NOTE:** Due to negative effects that cold water has on test strips; it is only recommended to use the liquid drop style testing kit on the cold portion your Chilly GOAT.

### ONCE A MONTH

Soak your filter elements overnight in a container with spa Filter Cleaner and then rinse with clean water. For best results, allow the filter to dry before re-inserting. When cleaning filters, be sure to never have the pumps (including the circulation pump) running without the filters in place. Failure to do so may result in debris being drawn into the pumps causing unwarranted damage. See Cleaning Your Filter Elements in the Maintenance section of this manual for more information.

### EVERY 180 DAYS

Drain and refill your Chilly GOAT with fresh water, clean the filter, and repeat the start up procedures. The filter should be replaced at least once every year. Over time and bather use, biofilm buildup can occur. Chemical products are available to help remove biofilm and should be used periodically before draining.

## WATER MAINTENANCE - SCHEDULE CONT.

### AS NEEDED

If the water looks hazy, make sure pH is in the proper range and treat with chlorinating granules to maintain free chlorine levels. Treat with non-chlorine shock (oxidizer shock) if free chlorine is less than total chlorine. Always refer to the chemical manufacturer's dosage recommendations listed on the container. Free chlorine levels should be maintained per the Water Chemistry Guide.

A defoamer may be used when excessive foaming occurs. Over use of a defoamer will result in cloudy, milky water. These are general recommendations for water maintenance that may vary by usage and bather load. Depending on bather load and frequency of use, drain and refill times may vary as well as the frequency of cleaning your filters.

## WATER MAINTENANCE

# TROUBLESHOOTING GUIDE

WATCH HOW-TO VIDEOS: [ChillyGOATtubs.com/pages/how-to-videos](https://www.ChillyGOATtubs.com/pages/how-to-videos)

PROBLEM	POSSIBLE CAUSES	HOW TO FIX IT
CHLORINE ODOR	Excessive chlorine	Shock water with oxidizer/non-chlorine shock treatment
	Low pH	Adjust pH if necessary
WATER ODOR	Low levels of sanitizer	Adjust sanitizer level with chlorinating granules
	pH out of range	Adjust pH if necessary
	Bacteria or algae growth	If sanitizer has already been adjusted, it may be necessary to perform a system flush
CLOUDY WATER	Dirty filters or inadequate filtration	Clean filters with filter cleaner and adjust filtration
	Unbalanced water chemistry	Test and adjust chemistry levels
	Old water	Drain, clean inner shell and refill with filtered water
CLOUDY AND GREEN WATER	Total alkalinity levels are low	Use a pH increaser
	Sanitizer levels are low	Apply oxidizer/non-chlorine shock treatment and adjust sanitizer
CLEAR GREEN WATER	High iron or copper content	Use a sequestering agent
	Sanitizer levels are low	Apply oxidizer/non-chlorine shock treatment
BROWN WATER	High iron or manganese level	Use a sequestering agent
FOAMING	High levels of body oils, lotions, soap, etc.	Add small amount of defoamer, an enzyme product and check water chemistry
	Low calcium hardness	Use a calcium hardness increaser
	Unbalanced water chemistry	Test and adjust chemistry levels
EYE OR SKIN IRRITATION	Unsanitary water	Adjust water chemistry according to testing results
	Total chlorine level above 5 ppm	Apply oxidizer/non-chlorine shock treatment
	Poor sanitizer/pH levels	Adjust pH level as necessary
SCUM DEPOSITS AT WATERLINE	Body oils and dirt	Use multi-purpose cleaner to clean surface and add enzyme product to Chilly GOAT water
CHALKY, WHITE SCALE DEPOSITS	Minerals present in the water and lack of sequestering agent use	When tub is drained, use a multi-purpose cleaner or white vinegar and scrub with a soft cloth
PITTING OF METAL FIXTURES	Low pH or total alkalinity	Check water chemistry and adjust



# REGULAR MAINTENANCE PROCEDURES

WATCH HOW-TO VIDEOS: [ChillyGOATtubs.com/pages/how-to-videos](https://ChillyGOATtubs.com/pages/how-to-videos)

**NOTE:** These maintenance procedures are the responsibility of the Chilly GOAT™ owner to perform. These procedures are not covered by the Chilly GOAT warranty.

## DRAINING YOUR VALARIS

Before you start draining your Chilly GOAT, be sure all power is turned off. Your Valaris requires periodic draining and cleaning to ensure a safe, healthy environment. It is recommended that you drain and clean your Chilly GOAT at least every 180 days or as necessary. Heavy use may require draining and cleaning more often. Draining times will vary between each side when using the equipped internal drain assembly. A sump pump may also be used to expedite the draining of the Chilly GOAT.

Caution and careful planning should be taken if draining in freezing temperatures to ensure the process is performed quickly (by use of a submersible pump) and that the water is either refilled quickly again or winterization steps are immediately performed. Try to plan your regular draining maintenance during times when temperatures are above freezing. Excess water in the plumbing can freeze in a short time frame depending on temperatures and conditions. Water freezing within plumbing and components can result in freeze damage which is not warranted.

**NOTE:** Although the hot tub and cold tub sections are independent bodies of water and plumbing systems, both operate off the same supply power. Both sides will be shut down any time the GFCI breaker is turned off. For this reason it is ideal to time draining and refilling of both sides at the same time.

## STEPS FOR DRAINING YOUR CHILLY GOAT

Each side of your Chilly GOAT Valaris is equipped with a drain assembly which can be located behind access panel “D”. The drains will be located in the equipment area attached to the frame near its respective hot tub or cold tub section.



Figure 1



Figure 1.1

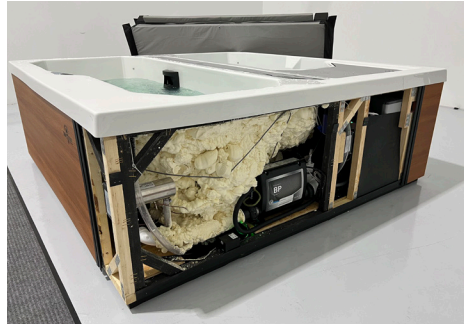

1. Remove the equipment area skirt panels by removing screws from the vertical trim piece. Lift up on the skirting panel and pull the bottom out to remove the skirting panel.
2. ❄️ Flex the plastic shroud barrier out and down to gain access to see in to the equipment area. Always place this shroud piece back in its original state, when no longer needing access in to equipment area. This protects against any rain water ingress from the cabinet intake vent.

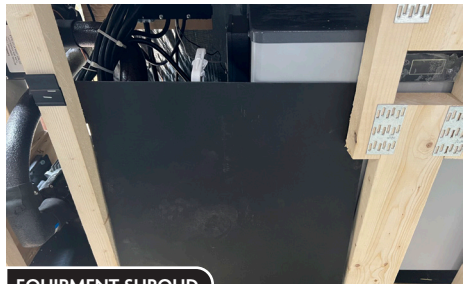

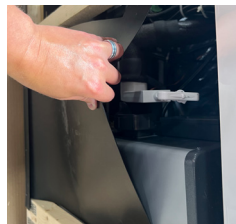

EQUIPMENT SHROUD



**NOTE:** Always put shroud back in its original position when done accessing equipment area, as this helps block any rain or water intrusion through the intake vent.



## REGULAR MAINTENANCE PROCEDURES CONT.

3.   To start the flow of water with this drain assembly; remove the cap, twist the face counterclockwise and pull out slightly on the face. A garden hose can be attached to the end of the drain assembly, if so desired.



DRAIN VALVE



**NOTE:** With the cap removed from the drain; water may drip or weep from the drain. This is normal. Be sure that the steps are followed in reverse order when draining is finished. Make sure that the drain cap is reattached and the valve is put back to the fully closed position so that there is no water leaking from the drain assembly.

**Note:** Always re-tie the drain valve back to frame member at the highest possible position (above normal water level).

### STEPS FOR USING A SUMP PUMP\*

Carefully lower submersible pump with hose connected into the bottom of Chilly GOAT™, taking care not scratch or gouge your shell surface.

4. Run the discharge end of the hose from your submersible pump to a desired location several feet away from your Chilly GOAT, where the water will drain away from foundation the Chilly GOAT is resting on.
5. Plug in/turn on your submersible pump.
6. Turn off/disconnect your submersible pump once it is no longer able to suck up any further water (indicated by a suctioning sound and water no longer coming out of the drainage hose). If you plan to fully wipe down and clean your entire shell surface, a shop vac can be used to remove the remaining small pockets of water in the Chilly GOAT.

\*Sump Pump is not provided with Chilly GOAT Valaris.

## CHILLY GOAT VALARIS SURFACE CARE

- During use, always remove debris and pollutants that have settled in the water or built up on the shell surfaces as it occurs. These pollutants can cause growth of bacteria, algae, fungus or biofilm if left on the surface and potentially cause stains.
- Clean the shell, jets and other controls with a soft cloth and shell cleaner to help remove residue and buildup on the shell surface. For any remaining buildup, white vinegar or mild scale remover product may be necessary to use with a soft cloth for removal. Consult with your local Chilly GOAT Support for additional cleaning products.
- Rinse the cleaned surfaces with fresh water from your garden hose and wipe with a soft cloth as doing so will help to remove residual cleaning agents (as some may cause foaming to occur in the water once unit is refilled).
- Always use an approved insulating cover by Master Spas to cover your Chilly GOAT when not in use, especially in outdoor installations where the unit is exposed to weather conditions and sun. Constant, prolonged exposure and use of an unapproved or non-insulating cover can result in damage to Chilly GOAT surface which would not be warranted.

## CARE OF YOUR SKIRTING CABINET

The Chilly GOAT cabinet is made from a UV resistant material. The cabinet requires only periodic cleaning with a stream of water from a garden hose. If necessary, use mild soap and water with soft cloth to wipe down cabinet surface. Rinse thoroughly.

## CLEANING YOUR FILTER ELEMENTS

The filter elements are one of the most important components of your Chilly GOAT™. Not only are the filters essential for clean water, but they also extend the life of the equipment and help avoid unnecessary water changes. Your filter elements should be cleaned on a regular basis, at least once a month on average with normal usage. The filters may need to be cleaned more frequently if the Valaris is used heavily, the water quality is poor, or their is high dissolved solid content

in the water. It's recommended to allow filter elements to fully dry after cleaning. For this reason, it is ideal to have a spare set of filters on hand for filter cleaning intervals.

1. Turn off the unit before servicing filters. Never leave the Chilly GOAT running when removing the filters. Debris can be pulled into the plumbing system and cause unwarranted damage.
2. Remove filter element(s).
3. With a garden hose, spray each element under pressure. Monthly, the standard filter elements should be soaked in a filter cleaner. Replace filter annually or as needed (depending on water conditions, use and cleaning, lifespan will vary).



**FILTER WEIR WITH SLIDE OFF ACCESS**

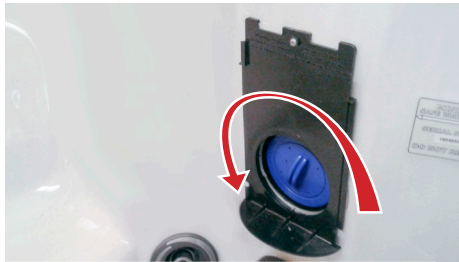

**TURN FILTERS COUNTER CLOCKWISE TO REMOVE**

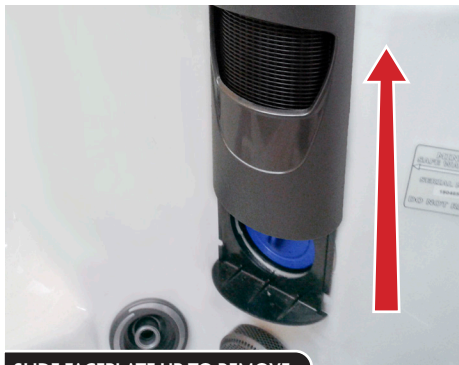

**SLIDE FACEPLATE UP TO REMOVE**



## CLEANING JETS 🔥

The majority of jets in your Chilly GOAT can

individually be turned on/off. If any of these jets become hard to turn, it will be necessary to remove the jet to clean it as grit/sand and mineral deposit may be present. The jets in your Chilly GOAT can be removed for cleaning by turning them counter-clockwise until they release and then pulling out the jet.

**TO CLEAN JETS:** Place the jet(s) in a container, fully immerse in white vinegar. Let the jet(s) soak overnight and then rinse with water. Reinstall the jet(s). It may be necessary to clean grit and deposits from the jet body (mounted in the shell surface) by using a small bristled brush.

## CARE OF YOUR CHILLY GOAT COVER

Always cover your Chilly GOAT when not in use with an approved insulating cover. Keep the cover on between uses (but not while it is being used). This will greatly reduce energy consumption and will cause the water to cool or heat more rapidly. Water loss and chemical usage will also be reduced.

- Ensure the cover is fitted tightly, as per manufacturer's instructions to maximize insulation.
- Be sure to lock down all straps on the cover after each use.
- Do not allow your Chilly GOAT to sit uncovered in direct sunlight. The heat and UV from direct sun exposure can cause damage to exposed shell surfaces as well as damage or discoloration of the internal fittings.
- See cover manual instructions for detailed instructions on proper cover care. Clean the cover at least once a month using mild soap and water. Rinse thoroughly with fresh water to remove pollutants and soap residue. If mold/mildew staining has occurred (particularly on bottom of the cover), a mixture of bleach and water used with a soft cloth may be necessary. Thoroughly rinse with fresh water after cleaning.
- Keep the cover open for 15 minutes after adding chemicals to prevent excessive off gas buildup and damage.
- When the cold tub is being used, the cover should be placed in a clean, dry area, otherwise it can pick up dirt and bacteria. Covers should not be put on wooden tables or wooden decking because of the risk of bleaching the wood.

## REGULAR MAINTENANCE PROCEDURES CONT.

**NOTE:** If your Chilly GOAT™ is going to be left empty for prolonged periods, do not place cover directly on the shell surface (closed and sealed). Instead, place a 1" block of high-density foam between the cover and the cold tub. This allows for ventilation to help reduce mold and mildew from occurring while the cold tub is empty.

**NOTE:** The cover warranty is not part of the limited warranty provided with the Chilly GOAT. It is provided through the cover manufacturer and may not be through Master Spas. Check the tags and labeling on your cover to verify manufacturer and refer to the manufacturer's care, maintenance, and warranty information. Your retailer or Master Spas Chilly GOAT support can help provide these details.

### CARE OF STAINLESS STEEL

Master Spas uses stainless steel in many of our products. Its lasting beauty and resistance to corrosion make it an excellent material for handrails and jets faces. With the proper care it will keep its luster for many years. All stainless steel can corrode given the right circumstances, so we have provided a guide to help you keep the stainless components in your Chilly GOAT looking nice. Stainless steel derives its ability to resist corrosion by forming a very thin transparent coating on the surface when exposed to oxygen. This coating can be damaged by abrasive materials such as steel wool or sand paper. Chlorine salts, sulfides, or other rusting metals can also erode this thin coating exposing the metal to corrosion. The best defense to combat corrosion on stainless steel components in your cold tub is to make sure that it is kept clean and free of any chemical build up.

#### ALWAYS:

- Clean frequently with fresh, clean water.
- Remove any rust spots as soon as they appear with vinegar or a brass, silver, or chrome cleaner.
- Use a good car cleaning wax for extra protection.
- Leave cover removed for at least 15 minutes after adding chemicals to the water.

#### NEVER:

- Clean with mineral acids or bleaches, steel wool or any other abrasive materials.
- Leave in contact with iron, steel any other metals.
- Close the cover immediately after adding

chemicals to the water.

**NOTE:** Failure to take proper care of the stainless steel could result in them rusting. Rusting is not covered by the warranty.

**NOTE:** Do not cover the Chilly GOAT for at least 15 minutes after adding chemicals as the off gas can cause unwarranted damage. It may be necessary to keep the cover open longer than 15 minutes when adding larger amounts of chemicals. It is recommended to check water more frequently to allow small dosages to be added as necessary versus large dosages being added less often.

## CARE OF THE UV SANITIZATION SYSTEM

**NOTE:** This regular maintenance for the UV Purification system is not covered under the warranty of the cold tub. Contact Master Spas or your Chilly GOAT dealer for recommendations on service.

**WARNING: BEFORE PERFORMING ANY MAINTENANCE ON THE UV PURIFICATION SYSTEM, MAKE SURE CHILLY GOAT IS SHUT DOWN.**

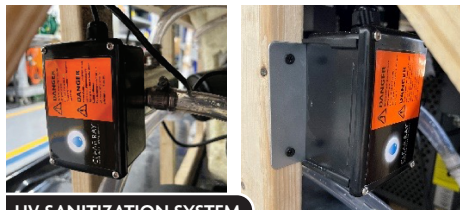

UV SANITIZATION SYSTEM

### MAINTENANCE – SEE FIGURE 1

Quartz tube (6) to be cleaned every six months of usage.

**DANGER:** Turn off power to the Chilly GOAT.

### QUARTZ TUBE (6) CLEANING INSTRUCTIONS:

- a. Open the Chilly GOAT's equipment access panels and disconnect the unit from the system control pack.
- b. Drain the cold tub.

**WARNING:** Allow UV-C lamp (20) to cool down prior to removing from the unit.

**DANGER:** Never look at the lit UV-C lamp (20). This can cause severe eye damage or blindness

- c. Drain water out of the unit completely.

- d. Remove enclosure cover (14).
- e. Make sure to use latex gloves when handling the UV-C lamp (20).

**Figure 1: Exploded View Note**

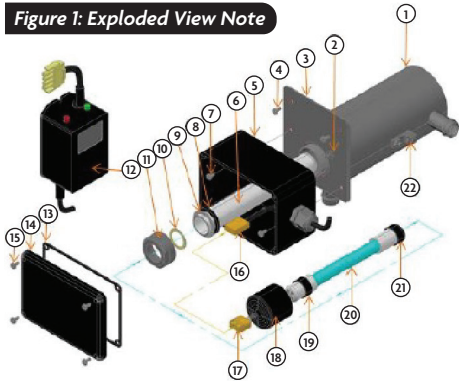

KEY	DESCRIPTION
1	REACTION CHAMBER
2	NUT KEP
3	MOUNTING BRACKET
4	MOUNTING SCREW (NOT PROVIDED)
5	ELECTRICAL ENCLOSURE
6	QUARTZ TUBE
7	SCREW 8 - 32 X 3/8"
8	QUARTZ SEAL GASKET
9	COMPRESSION WASHER
10	PLASTIC WASHER
11	COMPRESSION NUT
12	ELECTRONIC BALLAST
13	ENCLOSURE GASKET
14	ENCLOSURE COVER
15	SCREW #8 X 5/8"
16	BALLAST CONNECTOR
17	LAMP CONNECTOR
18	BOOT COVER
19	UPPER CUSHION
20	UV LAMP
21	LOWER CUSHION
22	GROUND LUG

- f. Disconnect UV-C lamp connector (17) from ballast connector (16).
- g. Slowly remove boot cover (18) and UV-C lamp (20) from quartz tube (6).
- h. Remove quartz seal compression nut (11).
- i. Use bare hands carefully to remove quartz seal gasket (8) and metal compression washer (9) that go over the quartz tube. Do

- not use any metal tools.
- j. Carefully remove the quartz tube (6).
- k. Clean the quartz tube (6) with paper towel or dry cotton cloth. Do not use abrasive cleaner as they can scratch the quartz tube surface. Household tub and shower lime removal products can be used if needed. Rinse the quartz tube (6) with clean water to completely remove any cleaning products that were used.
- l. Install the quartz seal gasket (8) over the opened end of the new quartz tube (6). Place the new quartz tube (6) into the unit with the domed end first making sure it is inserted and seated inside the quartz end holder on the bottom of the reaction chamber. Only about 1/8" of quartz tube (6) will be exposed when it is seated correctly.
- m. Reinstall the compression washer (9) over the open end of the quartz tube (6). Push it against the quartz seal gasket (8).
- n. Reinstall and **HAND TIGHTEN** the quartz seal compression nut (11) by turning it clockwise until it stops. Add another quarter of a turn by using a pair of Channel Lock pliers.
- o. Fill the cold tub. Make sure no water is dripping from the seal compression nut (11). If water is visible, **STOP** and tighten the compression nut another quarter of a turn with a pair of Channel Lock pliers to make sure it's completely sealed. Make sure there is no water leaking anywhere before proceeding to the next step.
- p. Turn the breaker back on. Make sure the circulation pump is running and moving water through the system. Wait for 5 minutes and assure no water is dripping. If water is visible, **STOP**, fix the leak by repeating the quartz tube maintenance process from step (a) to step (o).
- q. Turn off Chilly GOAT™.
- r. Slide the UV-C lamp (20) back inside the quartz tube (6). Install boot cover (18) over compression nut (11).
- s. Reconnect the UV-C lamp connector (17) to the ballast connector (16). Make sure the connectors mate completely. Do not use force.
- t. Reinstall the enclosure cover (14) with gasket (13) and secure with screws (15).
- u. Reconnect the unit to the system control panel and reinstall the equipment access panels.

## REGULAR MAINTENANCE PROCEDURES CONT.

- v. Turn ON the power to the Chilly GOAT.
- w. Once power is activated you can check the ballast to see if the unit is functioning. A solid green light indicates the unit is being provided power and should always be on. A solid red light indicates that UV-C lamp is activated.

The useful lifespan of the UV-C lamp (20) is approximately 12,000 hours. To keep your UV Purification System running at optimal performance, the UV-C lamp (20) should be replaced every 12-18 months of usage (during a drain and refill maintenance point falling between this time frame).

**NOTE:** Only use a proper replacement UV-C lamp (20), which can be acquired through your Master Spas or your Chilly GOAT dealer.

### UV-C LAMP (20) REPLACEMENT INSTRUCTIONS:

**DANGER:** Turn off power to the Chilly GOAT.

- a. Open the equipment access panels and disconnect the unit from the system control pack.

**WARNING:** Allow UV-C lamp (20) to cool down prior to removing from the unit.

**DANGER:** Never look at the lit UV-C lamp (20). This can cause severe eye damage or blindness.

- b. Remove enclosure cover (14).
- c. Make sure to use latex gloves when handling the UV-C lamp (20).
- d. Slowly disconnect old UV-C lamp connector (17) from ballast connector (16).
- e. Slowly remove old UV-C lamp (20) from quartz tube (6). Save the upper cushion (19) & lower cushion (21).
- f. Install the upper cushion (19) & lower cushion (21) to the NEW UV-C lamp (20).
- g. Slide the NEW UV-C lamp (20) into the quartz tube (6).
- h. Reconnect the NEW UV-C lamp connector (17) to the ballast connector (16). Make sure the connectors mate completely. Do not use force.
- i. Reinstall the enclosure cover (14) with gasket (13) and secure with screws (15).
- j. Reconnect the unit to the system control pack and reinstall the equipment access panels.

- k. Turn ON the power to the Chilly GOAT.
- l. Once power is activated you can check the ballast to see if the unit is functioning. A solid green light indicates the unit is being provided power and should always be on. A solid red light indicates that UV-C lamp is activated.

**WARNING:** The UV-C lamp used in this unit contains mercury. Properly dispose the old UV-C lamp in accordance with disposal laws. See [lamprecycle.org](http://lamprecycle.org).

### NONSLIP, COMFORT FLOOR SYSTEM

The exclusive Nonslip, Comfort Floor System is a standard feature on the Chilly GOAT models manufactured by Master Spas to provide better grip, traction and comfort. Making our Chilly GOAT's as safe and easy as possible to use while getting in and out.

### CARE & MAINTENANCE RECOMMENDATIONS:

Nonslip, Comfort Floor System cleans easily with soap, hot water and a brush (soft to medium bristle stiffness). Chlorine/bleach and water mixture, isopropyl rubbing alcohol or other household cleaner such as SoftScrub, Simple Green and 409 can be used to clean the pads.

Be sure any soap or cleaning product is thoroughly rinsed from the pads and shell surface and this residue is removed before re-filling swim spa to prevent foaming.

Always promptly attend to and clean any noticeable stains.

#### NEVER:

- Treat your water with bromine.
- Allow stains to develop without promptly being attended to and cleaned.
- Clean with acid based cleaning products.
- Use acetone or mineral spirits on Nonslip, Comfort Floor System or cold tub shell as damage caused to the Chilly GOAT™ shell from these chemicals would not be warranted.

**NOTE:** The Nonslip, Comfort Floor System is not compatible with the use of bromine sanitizer. Do not use this chemical.

# CHILLY GOAT TROUBLESHOOTING GUIDE

WATCH HOW-TO VIDEOS: [ChillyGOATtubs.com/pages/how-to-videos](https://www.ChillyGOATtubs.com/pages/how-to-videos)

**NOTE:** For wiring outside of U.S. and Canada, GFCI may be referred to as a RCD (residual current device). Be sure all local electrical codes are followed.

## GFCI IS TRIPPING

A ground fault circuit interrupter (GFCI) is required by the National Electrical Code for your protection. The tripping of the GFCI may be caused by a component on the Chilly GOAT™ or by an electrical problem. Electrical problems include but are not limited to, a faulty GFCI breaker, Chilly GOAT component, power fluctuations, and/or improper wiring. If this is a new electrical service and GFCI installation, an instantly tripping GFCI may likely be caused by improper wiring of the load neutral from the GFCI to the Chilly GOAT. It may be necessary to contact an electrician if your Master Spas dealer recommends doing so.

## NOTHING ON THE CHILLY GOAT OPERATES 🔥❄️

1. Check the control panel/heat pump display for any messages. If there is a message, refer to the diagnostic section on that control type. There you will find the meaning of the message and what action is to be taken.
2. If there is no message on the control panel or heat pump and both controls are completely dark (off), try to reset the GFCI breaker.



*The GFCI should be located in a weather proof box close to the Chilly GOAT, but no closer than 5 ft.*

*If the Chilly GOAT does not respond, or the GFCI breaker continues to trip, contact your Master Spas dealer or service organization.*

## HOT TUB NOT HEATING 🔥

If the hot tub heater has failed, the majority of the time it will trip the GFCI breaker. If the hot tub side is not heating and has not tripped the breaker, please follow these steps:

1. Check set water temperature at control panel to make sure it is set to desired temperature, above the current water temperature.

2. Check the “Heat Mode” that the Chilly GOAT is set in. The Chilly GOAT should be set in the Ready mode. Changing the Chilly GOAT to Rest mode changes the way the system heats and will primarily only heat during user programmed durations. See Hot Tub Control section for further details.
3. Check the control panel for heat indicator. If heat indicator is on, wait a reasonable amount of time (at least 1 hour for 240V systems) to see if the water temperature is rising.
4. If heat indicator does not remain on, the system should be displaying a message indicating why it can't heat. Check the control panel for diagnostic messages. Refer to Hot Tub Control Section titled System Related Messages. Follow steps to alleviate the message.
5. Check the control panel for light indicator. If the heat indicator is on, wait a reasonable amount of time (at least 1 hour for 240V systems) to see if the water temperature is rising.
6. Reset power to the Chilly GOAT at the GFCI breaker.
7. If it is still not heating, contact your Master Spas dealer or service organization.

## COLD TUB NOT HEATING/COOLING ❄️

If the Chilly GOAT™ is not heating/cooling and has not tripped the breaker, please follow these steps:

1. Check that the circulation pump is operating, and water is circulating.
2. Check that the heat pump is turned on, from its control panel.
3. Check the set water temperature to make sure it is set to the desired temperature, above the current water temperature for heating or below the current water temp for cooling. They heat pump should engage to warm or cool in 3-5 minutes.
4. If the heat pump is operating, close the cover and wait a reasonable amount of time to see if the water temperature is changing. You should notice the temperature changing within 1-3 hours.

## CHILLY GOAT TROUBLESHOOTING GUIDE CONT.

**NOTE:** For wiring outside of U.S. and Canada, GFCI may be referred to as a RCD (residual current device). Be sure all local electrical codes are followed.

5. If the heat pump is shutting down before the set temperature is met, the system should be displaying a message indicating why it has stopped operating. Check the heat pump control panel for diagnostic messages. Refer to Chilly GOAT™ Control Section titled System Related Messages. Follow steps to alleviate the message.
6. Turn off power for 5 minutes and then power the unit back on. The circulation pump should immediately start up and circulate water. In 3-5 minutes, the heat pump should begin operating if turned on and there is either a cooling or heating demand.
7. If your cold tub is still not heating/cooling, contact your retailer or Master Spas Chilly GOAT support for further troubleshooting assistance.

### WATER TEMPERATURE IS ABOVE SET TEMPERATURE (HEAT CREEP) 🔥

Because Master Spas hot tubs are well insulated and built to meet stringent energy standards, heat creep can occur. This means that the measured temperature of the water in your Chilly GOAT is creeping up higher than the set temperature on your control panel. Heat creep can occur as outdoor temperatures become moderate to warm or when your filter cycle durations have been adjusted above the default settings. To help manage heat creep:

1. Vent your cover. This means placing a folded cloth about ¾ inches (2 cm) thick under all four corners of the cover before you lock the cover down.
2. Open your cover. Opening the cover at night will also quickly cool the water down if desired.  
**NOTE:** Never leave a Chilly GOAT cover open and unsupervised.
3. Open all air controls. Temporarily leave the air controls open during cooler times of the day or night. Set your filtration cycles to run during this time as well.  
**NOTE:** If the heat creep issue has been resolved, close the air controls when not using the spa to reduce energy and chemical maintenance.

4. Reduce the length of your filter cycles. The default duration is generally 4.5 hours per day.
5. Visit your local Master Spas dealer for additional guidance. Heat creep can happen on well-insulated hot tubs, and is related to the environment where the Chilly GOAT is installed and equipment run times such as extended filter cycle durations. This is not indicative that there is a problem with the Chilly GOAT.

### PUMP(S) DO NOT OPERATE 🔥

1. Press the “Jets” button on your control panel.

If you hear the pumps trying to operate:

- A. Check that all the slice valves are open.
- B. Pump may be air locked and needs to be primed.

Refer to Installation Instructions section. If you do not hear anything from the pump, contact your Master Spas dealer or service organization.

**NOTE:** If the pump(s) had been operating for 15 minutes or longer prior to ceasing operation, it may be normal and simply related to mild or warmer temperature conditions and excessive internal temperatures occurring from prolonged pump run-times. The Chilly GOATs are built to meet stringent energy efficiency standards and to run at full capacity during the 15 minute safety timeout periods. Operating pumps at high speed repeatedly beyond the 15 minute timeout can result in the pump motor getting too warm and shutting itself off to cool down. This would be seen by the control indicating the pump should be on still, but the pump has shut itself off internally. If this thermal cutout occurs, the pump will remain off for several minutes to cool. Once the equipment area and motor cool down, it would begin operating again.

### POOR JET PERFORMANCE

1. Make sure pump is operating.
2. Check that the water level is adequate (up to minimum safe water level on sticker located near filter).
3. Make sure the jets are open and the air controls are open. Refer to Glossary of Chilly GOAT™ Technology section.



# WINTERIZING & STORING YOUR CHILLY GOAT

## WINTERIZING YOUR CHILLY GOAT

Your Chilly GOAT is designed to be used year round in any type of climate.

However, if you decide you don't want to use your Chilly GOAT in the winter, you must drain it and follow the winterizing steps listed below.\*

**DISCLAIMER:** Master Spas does not recommend winterizing your Chilly GOAT. If you choose to do so, any damage that may result is not covered under the limited warranty.

1. Drain your Chilly GOAT completely using the drain valve (if so equipped) or use an inexpensive submersible pump that you can buy from your local hardware store.
2. Use a shop vac to get all standing water out of your unit.
3. Remove access panels from equipment area.
4. Loosen all pump unions.
5. Remove winterizing plug from face of the pump(s) where applicable.
6. Using your shop vac in a blowing mode, insert the hose into the nozzle of each jet and blow the trapped water from the lines into the interior of the Chilly GOAT. A non-toxic, RV water line type antifreeze can be used and added to jets in each seat around your Chilly GOAT to help prevent freeze damage from occurring. Be sure to thoroughly flush the system before startup.
7. After this is completed, use the shop vac to remove any standing water in the floor and equipment areas.
8. Clean the shell surface with a soft cloth and a non-abrasive Chilly GOAT surface cleaner.
9. Replace access panels.
10. Cover the Chilly GOAT to prevent water from entering it and check the system periodically to be sure no water is entering and accumulating. Covers are a great

insulator but will allow some precipitation to enter. For this reason, it is highly advised to also cover the Chilly GOAT with a water tight tarp while winterized. It is beneficial to keep the cover slightly gapped off the acrylic shell while winterized to allow air flow in to the shell area to reduce mildew/mold buildup caused by trapped moisture.

\*If you decide to winterize your Chilly GOAT Valaris, we recommend that you periodically check the system throughout the winter to assure water is not entering through or around the Chilly GOAT cover.

## STORING YOUR CHILLY GOAT VALARIS

The shell surface should never be left unprotected and uninsulated while being stored. Clear plastic wrap or similar material should never be used to cover/protect the shell.

Prolonged, direct sun heat can damage the surfaces of the Chilly GOAT along with any components on the Chilly GOAT's surface. Always keep covered and protected with an insulating Chilly GOAT cover. Resulting damage such as cracking in the shell surface, warping or discolored components would not be warranted.

An empty system should never be exposed to temperatures below 0°F (-18°C) after delivery as extreme cold can cause shell damage. This includes storage and draining (winterizing). If your Chilly GOAT™ will be exposed to these temperatures, keep the unit filled and running. If you do not plan to use your Chilly GOAT, you can set the system to the lowest temperature setting allowed by the control system while in Standard/Ready Mode.

Failure to adhere to these guidelines may result in unwarranted damage caused to the Chilly GOAT.

# MODEL SPECIFICATIONS

NAME	CHILLY GOAT™ VALARIS GLACIER / TERRAIN
LISTING NUMBER	9957
DIMENSIONS (IN / CM) <sup>5</sup>	84" x 84" x 30" / 214 x 214 x 77
ELECTRICAL REQUIREMENTS <sup>1</sup>	Configuration #2 240V, 50A GFCI
CAPACITY <sup>2</sup>	3
<sup>3</sup> WATER CAPACITY (GALLONS / M <sup>3</sup> )	145 / 0.98
DRY WEIGHT (LBS / KILOS) <sup>4</sup>	1,075 / 488
FULL WEIGHT (LBS / KILOS) <sup>3,4</sup>	3,800 / 1,724

1. As configured from factory. See appropriate Electrical Requirements section for further details.
2. Total bather capacity in Chilly GOAT. The number of bathers in Chilly GOAT should never exceed indicated seating capacity. Do not allow additional bathers to enter if bather displacement results in water levels overflowing or reaching the lighting control which will potentially allow water to leak through the shell and into the equipment area.
3. Full weight based on dry weight of Chilly GOAT, max seating capacity of Chilly GOAT, assumed

- average weight per person of 185 pounds and estimated water weight of 8.34 pounds per gallon. Rounded up in increments of 5.
4. Manufacturing tolerances along with other factors can result in variance in actual Chilly GOAT weight. If weight is a critical figure necessary for delivery, or final installation, we suggest a minimum of 15% be added to the listed weight when planning delivery or installation.

# SITE PREPARATION/GENERAL GUIDELINES

Portable Chilly GOAT™ installation is simple when properly planned. It is important that you read the following information carefully and consult with your Chilly GOAT dealer.

**ACCESS:** The actual dimensions of your new Chilly GOAT will determine the amount of space that is needed in moving the unit from curbside to its final installation area. Be sure to consider and measure side yard dimensions, gates, doors, overall room dimensions and vertical obstructions such as ceilings, roof overhangs, balconies, and overhead cables. Any other space limiting obstacles such as stairs, trees, and shrubs must also be evaluated. Consideration should also be taken to ensure

there is a convenient water supply for filling your system (review national and local regulations). It is also good to consider these access requirements for ease of removing the Chilly GOAT from the premises in the event it is necessary to do so.

**SURFACE/PAD REQUIREMENTS:** When your new Chilly GOAT is filled with water and bathers, it can weigh thousands of pounds, see Model Specifications page for specific weight details. It is imperative that the base beneath the unit can support the entire weight. The Chilly GOAT must be on a uniformly firm, continuous, and level surface. The ideal, recommended foundation is a concrete pad

with a minimum thickness of four inches with steel reinforcement bars crossed throughout the pad.

**3. VENTILATION:** Your Chilly GOAT requires proper ventilation for efficient operation of the heating and cooling system. We recommend that the unit be installed at least 12" from the side vent to any wall or obstruction, and at least 6' of clearance from the heat pump output vent of the unit to any wall or obstruction to allow for proper airflow. Failure to provide proper air flow will result in reduced efficiency or could prevent heating and cooling. Never install the unit in a closed room with a limited air volume in which the air expelled from the unit will be reused, or close to shrubbery that could block the air inlet. Such locations impair the continuous supply of fresh air, resulting in reduced efficiency and possibly preventing sufficient cooling/heating output.

**4. CONDENSATION PRESENCE & DRAINAGE:** It is normal for your Chilly GOAT to drain water from the condensation drain line, as well as have areas within the unit build up condensation which can drip out of the unit. Water can accumulate either from condensation buildup, defrost cycles, or rainwater entering the chiller vents in the cabinets (if outdoors). It is particularly common to see water exiting the unit in areas of high humidity, a recent rainstorm (if outdoors),

and/or during a heat cycle. This is normal and does not indicate a leak in the unit. The area where the unit is being placed must be able to withstand presence of water and high humidity.

**IMPORTANT:** Consult experts and/or local authorities to review and comply with all local and national laws and regulations relating to childproofing, safety barriers, lighting, and any other safety requirements at site. When installing your Chilly GOAT indoors, on a wood deck, roof or balcony, load requirements need to be evaluated before installation. It is also good to consider the location and position of cold tub as well as surfaces and foundation to minimize noise disturbance as much as possible. You should speak with a qualified contractor or your local building department to confirm that your surface is adequate for supporting the Chilly GOAT and conforms to these guidelines.

All sides of the Chilly GOAT must be accessible for regular maintenance or in the event service is needed. Periodical maintenance checks require entry into the equipment bay. When possible, it is wise to plan for future service needs, leaving at least 3' of access to 3 of the sides and 6' for the side with heat pump output ventilation.

**WAIT 24 HOURS TO FILL AND START YOUR CHILLY GOAT VALARIS ONCE IT IS IN PLACE.**

## ELECTRICAL REQUIREMENTS

### CONFIGURATION 2: 240V, 50A GFCI

**NOTE:** Electrical requirements by model is shown in Model Specifications. Only electrical configurations pertaining to the models referenced in this manual are shown.

## ELECTRICAL REQUIREMENTS

### HAVE YOUR ELECTRICIAN READ THE FOLLOWING INFORMATION BEFORE INSTALLATION BEGINS

Electrical connections made improperly, or the use of wire gauge sizes for incoming power which are too small, may continually trip breakers, blow fuses in the electrical equipment box, damage the internal electrical controls and components, be unsafe and, in any case, will void your warranty.

It is the responsibility of the Chilly GOAT owner to ensure that electrical installation supplying, and connecting to the Chilly GOAT,

is performed by a properly qualified, licensed electrician in accordance with the with all applicable local, regional, state requirements, and current effective edition of the National Electrical Code at the time of installation.

These connections must be made in accordance with the wiring diagrams found inside the control box. This equipment has been designed to operate on 60Hz. alternating current only, 120/240 volts are required. Make sure that power is not applied while performing any electrical installation. A bonding lug has been provided on the electrical equipment pack to allow equipotential bonding connection for bonding conductors. The bonding conductor shall be at least 10 AWG

# ELECTRICAL REQUIREMENTS CONT.

## CONFIGURATION 2: 240V, 50A GFCI

copper and must be connected according to the current effective and applicable local, regional, state and edition of the National Electrical Code. The Chilly GOAT requires a 50-amp, single phase, 120/240 volt, four wire supply (two ungrounded line conductors, one grounded neutral conductor and one grounding conductor). The disconnect must be readily accessible to the Chilly GOAT occupants but installed at least five feet from the Chilly GOAT. A Ground-Fault Circuit Interrupter (GFCI) must be used to comply with section 680-42 of the National Electrical Code. A ground fault is a current leak from any one of the supply conductors to ground. A GFCI is designed to automatically shut off power to a piece of equipment when a ground fault is detected, and, its operation, should be tested frequently before use.

The electrical supply to the Chilly GOAT must be an individual branch circuit 120/240V, 50A, 4 wire, with ground (#6 AWG copper with minimum #10 AWG copper ground).

Route the electrical supply into the equipment area, by cutting an appropriate opening either through the bottom or side cabinet, for final hook-up to terminals inside the Chilly GOAT control system. The Chilly GOAT must be connected to an "individual - dedicated" 120/240-volt, 50-amp breaker and GFCI. The term "individual - dedicated" means the electrical branch circuit for the Chilly GOAT is not being used for any other electrical loads (i.e. patio lighting, appliances, garage circuits, etc.). If the Chilly GOAT is not connected to an individual-dedicated branch circuit, overloading may result in "nuisance tripping" which will require resetting of the breaker at the house electrical panel.

202301

## CONFIGURATION 2 240V, 50A GFCI

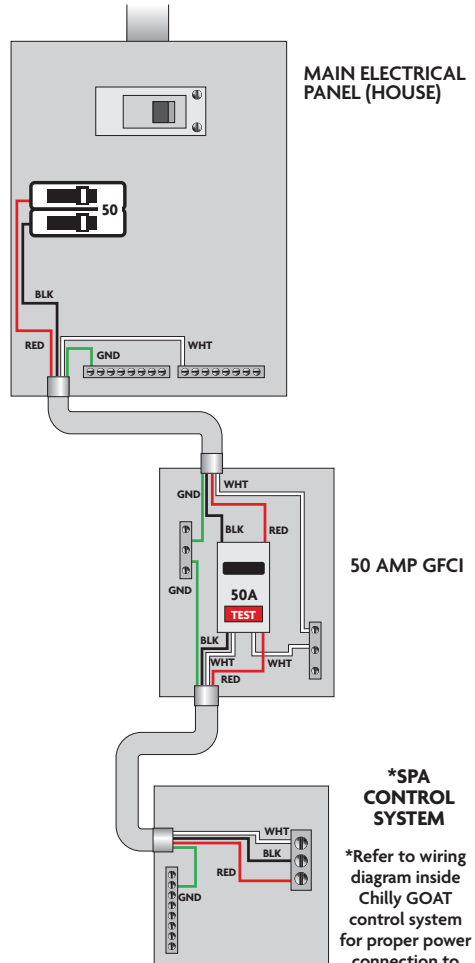
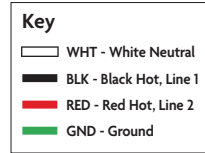

# INITIAL CHILLY GOAT SET UP

WATCH HOW-TO VIDEOS: [ChillyGOATtubs.com/pages/how-to-videos](https://www.ChillyGOATtubs.com/pages/how-to-videos)

## PLACING YOUR CHILLY GOAT

The Chilly GOAT™ requires a dedicated 120/240V, 50A 4 wire, with ground electrical supply. Be sure the GFCI breaker you are hooking your Chilly GOAT up to meets all local codes. Check with an Electrician to be sure.

All Master Spas products must be placed on a flat, level surface. A concrete pad is ideal, but a reinforced deck or properly prepped stone pad may also be suitable. Check your specific model details to determine the filled weight of your Chilly GOAT and prep the area accordingly. Placing your Chilly GOAT directly on the ground is unacceptable. Decks and stone pads are more susceptible to sinking and settling. If the Chilly GOAT is not held flat/level between its frame and bottom of the shell, it can cause unwarranted problems with the shell and/or performance of your Chilly GOAT. All issues associated with improper placement are not covered by the limited warranty.

**ATTENTION: BE SURE TO WAIT TO FILL AND POWER YOUR CHILLY GOAT FOR 24 HOURS AFTER IT HAS BEEN MOVED IN TO PLACE.**

## SETUP STEPS

1. Place the Chilly GOAT Valaris in its final position that allows for access to equipment and Chilly GOAT components. Master Spas recommends that at least 3 feet of space be provided around all sides of the Chilly GOAT for access. Leaving 6' of open Chilly GOAT for the heat pump side for appropriate ventilation. This provides adequate space for regular maintenance and service.



2. Remove the equipment access panels. The cabinet panels are removed by lifting the panel section vertically until it stops

and then carefully pulling the bottom outward at an angle to unhook it from the channel. Although one person can do so, it is convenient to have a helping hand when removing the longer side panels.

3. With the equipment access panels removed, be sure all pump and heater unions are secure. The therapy pump, heater, and heat pump each have 2 unions. A newly delivered Chilly GOAT may have loose unions caused in transporting the Chilly GOAT. Check that all slice valves are open, in the up position. The slice valves may become closed during transportation of the Chilly GOAT.
4.  Steps for attaching the condensation drain line to the Chilly GOAT.



- Locate the manufacturer installed drain line placed along the bottom of panel “C” of the Chilly GOAT below the cabinet.
- Use the additional, included length of clear 3/8”ID hose to couple and route the drain line away from the unit, so it does not allow water to return toward the Chilly GOAT.

**NOTE:** It is normal for your Chilly GOAT to drain water from the condensation drain line. Water can accumulate either from condensation buildup, defrost cycles, or rainwater entering the chiller vents in the cabinets. It is particularly common to see water exiting this connection in areas of high humidity, a recent rainstorm, and/or during a heat cycle. This is normal and does not indicate a leak in the unit. As recommended in Site Preparations and General Guidelines, be sure site design and materials are intended to withstand water presence and high humidity.

- The heat pump is designed to capture this water and route it to the condensation drain line and out to a safe, appropriate drainage spot external to the unit. Special care should be taken when planning for an indoor installation, so this water can be routed to an appropriate drain.

## INITIAL CHILLY GOAT SET UP CONT.

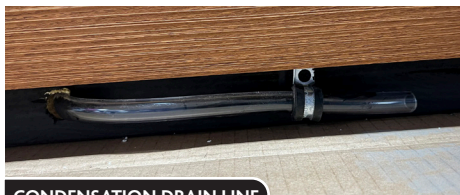

CONDENSATION DRAIN LINE

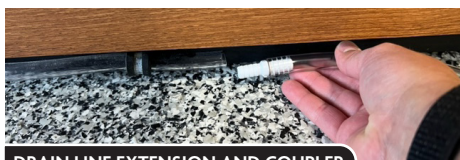

DRAIN LINE EXTENSION AND COUPLER

5. ❄️ Attach the provided thermometer to the filter housing to allow the temperature to be read, confirming safe water temperatures, before each use.



THERMOMETER

6. Using a garden hose with prefilter on the end, fill each side of the Chilly GOAT™ to the minimum safe water level labels located on the side wall near the filter area. When filling or topping off water, do not exceed the maximum fill level indications on the water level labels.

**NOTE:** When filling the Chilly GOAT from empty, always make sure to remove your filter. This can help the pump prime.



FILTER REMOVED

**IMPORTANT:** In below freezing temperatures, caution should be taken when planning to install a Chilly GOAT and fill it with water. As

it takes time for the water to fill each side of the unit and reach the proper minimum water levels, the water entering the various plumbing lines and equipment may begin to freeze when done in winter weather conditions. This could result in pumps being seized until thawed or other potentially worse freeze damage occurring to the equipment and plumbing lines.

7. ❄️ Once both portions are filled to the minimum water level, turn the power on to the Chilly GOAT. Your circulation pump and heat pump on the cold tub portion should start up immediately. If you hear the pump running but there is no water flow circulating, power down the system for a minute and power it back on. If there is a little bit of water movement, the pump is priming and will be fully primed within 5 minutes. Do not let the circulation pump run without water flow for more than 1 minutes without powering down and restarting. Allowing the circ pump to run without water flow will cause unwarranted damage.
8. ❄️ If the pump is not priming after turning off and restarting a couple times, turn off the power, make sure your filter is removed, hold the garden hose without the prefilter on it up to on of the jets and place the palm of your hand over the other jet. Hold this for up to 30 seconds or until you see a bubble “burp” from the filter area. Restart the system and check water flow. Repeat if necessary.

**NOTE:** If an E03 message comes up on the screen while the pump is trying to prime, this is okay. It is just an indication that there is not enough flow. The code will go away once the pump has been primed.

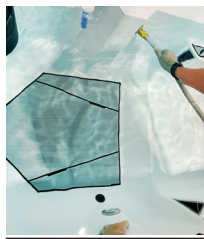

BURPING THE PLUMBING

9. 🔥 Once the cold portion has primed, turn the Chilly GOAT back off to address the startup of the hot tub portion. Turn the system back on and wait until the system and topside control panel are in an operational state. Activate the Jets button to confirm the therapy pump is not air

locked. The light button can be used to engage the circulation pump to confirm it has primed. Using these button, turn the circulation pump and then the therapy pump on and off to confirm water flow. Check the circulation pump flow by feeling in front of the circulation pump discharge. See the TP500 Chilly GOAT™ controls section of this manual for additional instructions on control startup.



**NOTE:** Due to the nature of water flow and hydro-therapy pumps, please be advised that air locking of pumps may occur. Master Spas has taken measures to reduce the possibility of this, but it still may occur, especially after refilling a Chilly GOAT. This is not a service covered under warranty and service charges may apply.

**NOTE:** To relieve an airlock situation, loosen the pump union on the discharge of the pump. This pump union is indicated by an arrow in the picture below. Water should leak out of the union once the air has been removed. Tighten the union and test the pump for proper operation. Repeat this process.

10. 🔥 Be sure the adjustable jets in your Chilly GOAT are open by turning the face of the jet. Most of the jets in the hot tub portion are adjustable and removable by turning the face of the jet.

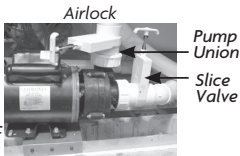

11. ❄️ Once both the hot tub and cold tub sections have primed, you will need to either access the heat pump control panel or connect the heat pump Wi-Fi (if desired) to engage the heat pump. To access the heat pump control panel, use your #1 square head screw driver to remove the black vertical trim piece on the right side between panel "D," and "C". The heat pump control panel is located between wood framing, behind this vertical trim piece. To adjust the water temperature to your desired setting, you will either need to wait 10 minutes for the Wi-Fi pairing "NET" indication to end or set up Wi-Fi connection for control (see Clim8Zone Heat Pump Controls).
12. Your cold tub ❄️ will need some time to cool. The cooling or heating capabilities will vary depending on ambient temperature conditions, ventilation air flow at site and the current water temperatures. Its exciting and tough to wait, but give your cold tub a couple hours between water temperature checks. Your hot tub 🔥 water will heat approximately 3 to 4 degrees Fahrenheit per hour (1 to 2 degrees Celsius) with the cover placed on the Chilly GOAT. This varies depending on the size of the Chilly GOAT and ambient temperatures.
13. Adjust water chemistry in hot and cold sections according to the instructions provided in the Water Maintenance section.
14. Step into the soothing warmth or exhilarating cold of your Michael Phelps Chilly GOAT.

## CLIM8ZONE HEAT PUMP CONTROLS







### HEAT PUMP CONTROL PANEL







**NOTE:** This display is found on the heat pump itself. To access this control panel, take off the trim piece on the equipment end by removing the 3, #1 square head screws (square bit supplied in luggage pack). The control panel will be positioned in an opening of the frame.

# CLIMBZONE HEAT PUMP CONTROLS CONT.

## BUTTON DESCRIPTION



No	Key	Description
1		Turn ON/OFF the controller panel
2		Increase the setting values
3		Decrease the setting values
4		Change modes
5	Red LED On	Heating mode
6	Green LED On	Cooling mode
7	The red light and the green light on for 3 seconds at the same time, then the red light on	Auto heating/cooling, currently heating
8	The red light and the green light on for 3 seconds at the same time, then the green light on	Auto heating/cooling, currently cooling
9	Red LED flashing	Defrosting mode
10	Red & Green LED Off	Heat pump OFF

## OPERATION INSTRUCTIONS:

- Turn  ON/OFF
  - Press the button for 2 seconds.
- Mode  conversion
  - Press button to switch heat/cooling mode; Heating = Red LED on; Cooling = Green LED on.
- Change temperature unit Fahrenheit/Celsius
  - Long press three buttons    at the same time to switch the display of Fahrenheit and Celsius
- Change Set Temperatures
  - Set temperatures can be adjusted by pressing Up  or Down  buttons.
  - The target temperature setting range is between 40F-104F (5C-40C).
  - The heat pump operates on a 2F differential, for heating and cooling triggering. In example, a set target temperature of 40F (4C) would result in

the unit maintaining +/-2F or 38F-42F (3C-6C) water temperatures, before heating or cooling is triggered again.

### 5. Forced defrosting:

- When the outer coil pipe temperature is below the Exit Defrosting Temperature, press two buttons   for 3 seconds to enter the Forced Defrosting.

**NOTE:** In warm climates with warm water temperatures, you may experience error messages as the system tries to cool. See E21 - ambient temp error troubleshooting for additional suggestions.

**ATTENTION:** If changing settings and an option comes up showing codes beginning with "A" or "P," Do not press any more buttons. Wait for the screen to timeout. These parameters/settings should only be accessed under guidance of Master Spas.

## ERRORS & TROUBLESHOOTING OF THE HEAT PUMP

Key factors for proper operation are good water flow through the circulation pump and the heat pump as well as proper ventilation space around the unit. As the filter dirties, it will begin limiting flow through the circulation pump and can cause flow related errors. Clean the filter regularly and replace as needed. The unit should have 6' of space on the output ventilation side of the heat pump and minimum of 12" around the rest of the unit (ideally and recommending that there be at least 3' clearance for access).

### \*E20 SUB ERRORS:

These messages will alternately display on the screen every 3 seconds with the original E20 error message. These messages will need to be provided to your Chilly GOAT™ retailer support team, for troubleshooting purposes and necessary corrective actions.

<b>E03 – Water Flow Failure</b>	Clean or replace filter. Check circulation pump operation making sure there is water flowing. Make sure gate valves are in full open position. Repeat step 8 in the initial setup instructions.
<b>E04 – Winter Anti-Freezing</b>	Freezing temperatures have been detected. Check floating thermometer water temperature. Confirm circulation pump is operating and there is water flow in the unit. If water temps are 35F (2C) or less, adjust to heating mode and consider setting higher set temperature. Do not allow water to freeze and unwarranted damage to occur from freezing. Contact Master Spas or your retailer for support if unit is not able to heat and increase current water temperatures.
<b>E05 – High Pressure Protection</b>	Shut down power for 5 minutes and turn back on. If persists, contact Chilly GOAT support or your retailer for support.



<b>E06 – High Pressure Protection</b>	Low Pressure Failure. Shut down power for 5 minutes and turn back on. If persists, contact Chilly GOAT support or your retailer.
<b>E09 – Communication with Upper Computer Failed</b> (communication with Balboa system failed)	Shut down power for 5 minutes and turn back on. If persists, contact Chilly GOAT support or your retailer for support.
<b>E10 – Communication Fault of Frequency Conversion Module</b> (alarm when communication is disconnected between external board and drive)	Shut down power for 5 minutes and turn back on. If persists, contact Chilly GOAT support or your retailer for support.
<b>E12 – Exhaust Too High Protection</b>	Exhaust has started re-entering the system. Check ventilation around the unit. Make sure there is 6' of open space on the output ventilation of the heat pump. If persists, contact Chilly GOAT support or your retailer for support.
<b>E15 – Inlet Water Temp Error</b>	The incoming water temperature is giving strange readings. This could be an internal heat pump sensor error. Shut down power for 5 minutes and turn back on. Confirm circulation pump operating and flowing water. If persists, contact Chilly GOAT support or your retailer for support.
<b>E16 – Outer Coil Pipe Temp. Error</b>	The outer coil has exceeded its temperature limit. Shut down power for 5 minutes and turn back on. Confirm circulation pump operating and flowing water. Check ventilation around the unit. Make sure there is 6' of open space on the output ventilation of the heat pump. If persists, contact Chilly GOAT support or your retailer for support.
<b>E18 – Exhaust Gas Temp. Error</b>	The exhaust gas has exceeded its temperature limit. Shut down power for 5 minutes and turn back on. Confirm circulation pump operating and flowing water. Check ventilation around the unit. Make sure there is 6' of open space on the output ventilation of the heat pump. If persists, contact Chilly GOAT support or your retailer for support.
<b>E19 – DC Fan Motor Failure. Error</b>	The DC fan motor has stopped function. Check for physical damage to the fan motor. Check power going to fan motor. If persists, contact Chilly GOAT support or your retailer for support.
<b>*E20 – Abnormal Protection of Frequency Conversion Module</b>	This error message will alternately display E20 and a sub error message. Sub errors listed below. Shut down power for 5 minutes and turn back on. If persists, contact Chilly GOAT support or your retailer for support. Be prepared to provide sub codes seen.
<b>E21 – Ambient Temp. Error</b>	The temperature in the cabinet is too high, or the water temperatures and ambient temperatures are too warm for cooling operation to occur. Check ventilation around the unit. Make sure there is 6' of open space on the output ventilation of the heat pump. Shut down power for 1 hour and turn back on. Wait until cooler evening or morning to try to start up heat pump. Cool the water by either partially draining and refilling or adding ice to the water to jump start the cooling process. This is more susceptible to occur when ambient temperatures and water temperatures are 90F (32C) and higher. If persists, contact Chilly GOAT support or your retailer for support.
<b>E23 – Too Low Cooling Outlet Water Temp Protection. Error</b>	Too little water is exiting the heat pump. Check for clogs or blockages in the jet lines. If the issue persists, contact Chilly GOAT support or your retail for support.
<b>E27 – Water Outlet Temperature Failure</b>	The water outlet sensor is receiving strange readings. Shut down power for 5 minutes and turn back on. If persists, contact Chilly GOAT support or your retailer for support.
<b>E29 – Return Gas Temp. Error</b>	The return gas has reached its temperature limit. Shut down power for 5 minutes and turn back on. If persists, contact Chilly GOAT support or your retailer for support.
<b>E46 – DC fan error</b>	Check fan blade for damage. Shut down power for 5 minutes and turn back on. If persists, contact Chilly GOAT support.

<b>ERROR CODES</b>	
1 – IMP Over-Current	257 – Communication Failure
*2 – Compressor Synchronous Abnormal	258 – AC Input Phase Absent
8 – Compressor Output Phase Absent	260 – AC Input Over-Current
16 – DS Bus Low Voltage	264 – AC Input low voltage
32 – DC Bus High Voltage	272 – Compressor High Pressure Failure
64 – Radiator Over Temperature	288 – IMP Too High Temperature
128 – Radiator Temperature Error	320 – Compressor Peak Current Too High
*E20-2 - Can relate to warm water temperatures in combination with hot ambient temperatures. See E21 instructions as well.	

## WI-FI CONNECTION & OPERATION

1. Confirm you have a means of connecting the Clim8zone (heat pump) to dedicated 2.4GHz Wi-Fi signal. If you cannot set such from your Wi-Fi router, there will not be proper, reliable connection.
2. The heat pump offers 2.4GHz Wi-Fi connectivity option. If you desire to utilize this feature for control of heat pump and set temperature settings, you'll need to start by downloading the app:
  - a. Go to "Google Play Store" or "Apple App Store"

# CLIM8ZONE HEAT PUMP CONTROLS CONT.



- b. Search for “Smart Life” app and download. The app icons in the app stores should look like the icon below.
  - c. Sign up and register to create your account.
3. Setting up the heat pump and mobile phone for pairing:

- a. Power up your Chilly GOAT.
- b. Make sure circulation pump is pumping water through the heat pump.
- c. View the heat pump control screen:
  1. Turn on the Clim8zone II heat pump, from the main control panel on the unit.

2. The Clim8zone will automatically go to pairing mode for 10 minutes. Pair the Clim8zone with your mobile device within this 10 minute time-frame. While in pairing mode, the word “nEt” will be flashing on the front control screen of the heat pump and stay flashing until Pairing is done.



- d. On your mobile device, turn on Wi-Fi and Bluetooth.
- e. Connect your mobile phone to your home 2.4 GHz Wi-Fi connection.

**NOTE:** Clim8zone II only works with 2.4 GHz connection and will NOT work with 5GHz

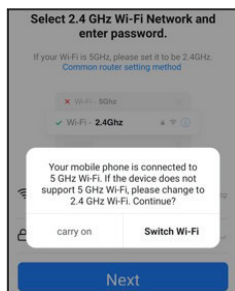

connection. When your mobile device is connected to a 5 GHz network, the app will detect and prompt a message asking you to change to 2.4GHz Wi-Fi. Please do so before proceeding forward.

**NOTE:** It is common for routers to have both 2.4 and 5 Ghz

connections. Consult your wireless router manual to review details and possible settings, to ensure dedicated 2.4GHz Wi-Fi connection can be made.

4. Pairing
- a. Open the “Smart Life” app.

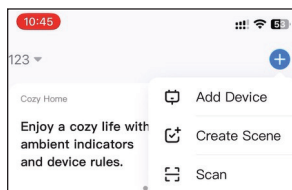

- b. Login to enter the main interface.
- c. Click the “+” in the upper right corner and select “Add Device.”
- d. The interface will show “Discovering devices...” Click “Add” to enter “Add Device” interface.

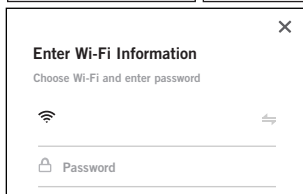
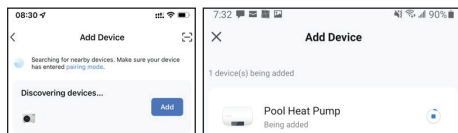

**NOTE:** It is possible to add your device manually clicking on “Large Home Appliances,” then choose “Water Heater (Wi-Fi).” This is how the app classifies the heat pump.

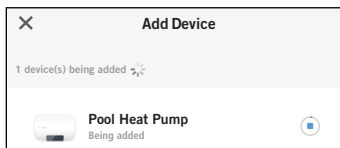

- e. Select the same 2.4 Ghz Wi-Fi network with your mobile device and enter password created previously.
- f. Click “Next.” The interface will show “1 devices being added.” Be patient as it will take some time for the device to be added.

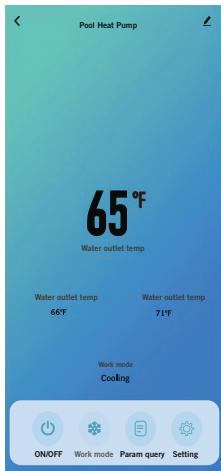

g. When the device is added successfully, the interface will show “1 device(s) added successfully.”

**NOTE:** It may take several times to pair depending on the strength of your Wi-Fi signal. Retry as needed or address providing stronger 2.4GHz Wi-Fi signal to the area that the unit is located.

h. Click “Done” to enter the app Homepage.

## 5. App operation

a. After the device is successfully added, click “Pool Heat Pump” (your app may show a different name) in the “All Devices” section of the main interface of the “Smart Life” app to enter the “Pool Heat Pump” operation page.

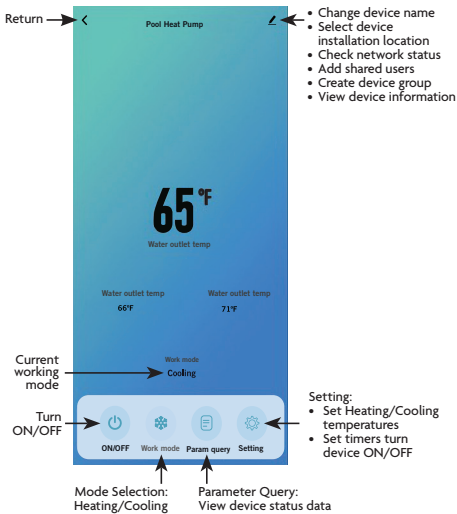

## 6. Icons



- Select device installation location
- Check network status
- Add shared users
- Create device group
- View device information



Return to previous page



Turn the Clim8zone II on ON/OFF



Set Heating or Cooling mode



View device status data



f. Set Heating/Cooling temperatures

g. Set timers turn device ON/OFF

## 7. Sharing Device

a. The “Share Device” feature in the Smart Life app allows you to share access to your heat pump with other Smart Life app users. This can be useful if you want to give family members access to control the heat pump, or if you want to give access to a technician who needs to troubleshoot the heat pump remotely. To use “Share Device” feature, follow the following steps:

- Click on “Share Device”
- Enter the email address or Smart life username of the person you want to share.
- Choose the level of access you want to grant to the person. You can choose between “Device Control” (control heat pump operation only) and “Device management” (control heat pump, add/remove users and change setting.) Click “Confirm.”
- The person you have invited will receive an email or notification in the Smart Life app with instructions on how to accept the invitation and gain access to the heat pump. They will need to have their own Smart Life account to accept the invitation.

# CLIMBZONE HEAT PUMP CONTROLS CONT.

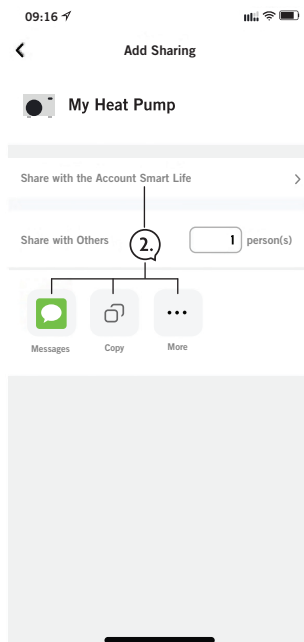
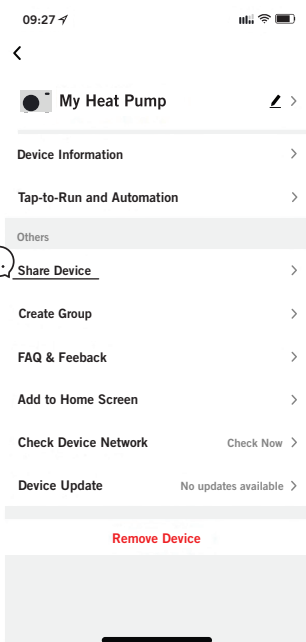
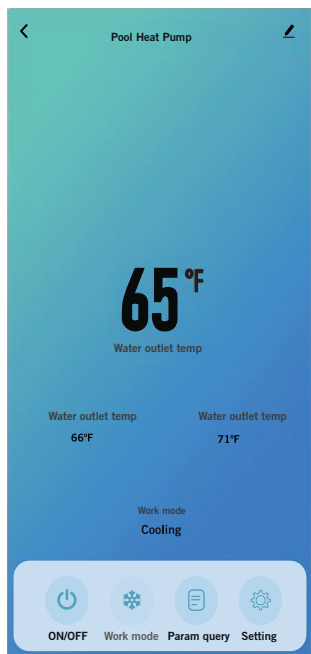

# TP500 CONTROL PANEL



## DISPLAY ICONS



- |                             |                                  |
|-----------------------------|----------------------------------|
| A. Heat                     | I. Jets 2                        |
| B. Ready Mode               | J. Blower                        |
| C. Rest Mode                | K. Auxiliary (Jets 3)            |
| D. bbaTM2 On                | L. Temperature Range (High/Low)  |
| E. Wi-Fi (Cloud Connection) | M. Set (Programming)             |
| F. Light                    | N. Filter Cycle (1 or 1 or Both) |
| G. Cleanup Cycle            | O. AM or PM (Time)               |
| H. Jets 1                   |                                  |

\*Some icons may not apply. Equipment and accessories will vary by model.

- \*D - if equipped, options vary by model
- \*E - If equipped, aftermarket accessory
- \*G - Does not apply to all systems
- \*I - If equipped, option vary by model
- \*K - if equipped, options vary by model
- \*J - Not applicable

## NAVIGATION

Navigating the entire menu structure is done with 2 or 3 buttons on the control panel. The up, WARM, and down, COOL, buttons are used to navigate the menu options.



The MENU Button is used to choose the various menus and navigate each section.

Typical use of the Temperature button(s) allows changing the Set Temperature while the numbers are flashing the LCD. The menus can be exited with certain button presses. Simply waiting for a few seconds will return the panel operation to normal.

# POWER-UP SCREENS

Each time the System powers up, a series of numbers are displayed. After the startup sequence of numbers, the system will enter Priming Mode.

## Key

-  Indicates Flashing or Changing Segment
-  Indicates Alternating or Progressive Message - every 1/2 second
- A temperature button, used for "Action"

Waiting time that keeps the last change to a menu item.

\*\*\*\*\* Waiting time (depends on menu item) that reverts to original setting and ignores any change to that menu item.

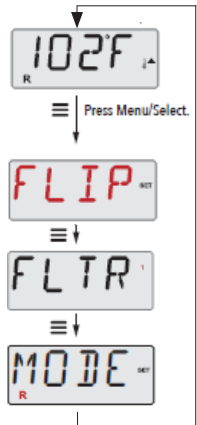

## INITIAL START-UP

### PRIMING MODE

This mode will last for 4-5 minutes or you can manually exit the Priming Mode after the pump(s) have primed, by pressing the WARM or button.

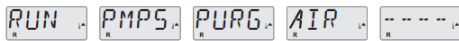

Regardless of whether the priming mode ends automatically, or you manually end the priming mode, the system will begin normal heating and filtering operations when Priming Mode ends. During the Priming Mode, the normal system's programming and heating is disabled to allow the priming process to be completed by the user without the possibility of turning on the heater under low-flow or no-flow conditions. Nothing comes on automatically, but the pump(s) can be energized by pushing the JETS button. If the Chilly GOAT™ has a dedicated Circulation Pump, it can be activated by pressing the LIGHT button during Priming Mode.

### PRIMING THE PUMPS

As soon as the Priming Mode screen appears on the panel, select the "Jets" button once

to start the therapy pump. If the pump is operating but there is no water flow after 10 seconds of running, shut the pump off for 5-10 seconds and then back on for 5-10 seconds. Repeat until water begins flowing, this means the pump is primed. If the pumps have not primed after 4-5 minutes, and water is not flowing from the jets in the Chilly GOAT, do not allow the pumps to continue to run. Turn the Chilly GOAT off, then back on and repeat the process.

**NOTE:** Turning the power off and back on again will initiate a new pump priming session. Do not do this more than 5 times. If the pump(s) will not prime, shut off the power to the Chilly GOAT and see instructions for relieving an air lock in the Initial Chilly GOAT Setup section.

**IMPORTANT:** A pump should not be allowed to run continuously without priming for more than 2 minutes. Under NO circumstances should a pump be allowed to run without priming beyond the end of the 4-5 minute priming mode. Doing so may cause damage to the pump and cause the system to energize the heater and go into an overheat condition.

### EXITING PRIMING MODE

You can manually exit Priming Mode by pressing a Temperature button, WARM (Up) or COOL (Down). Note that if you do not manually exit the priming mode as described above, the Priming Mode will be automatically terminated after 4-5 minutes. Be sure that the pump has been primed by this time. Once the system has exited Priming Mode, the top-side control panel will momentarily display the set temperature but the display will not show the temperature yet, as shown below. This is because the system requires approximately 1 minute of water flowing through the heater to determine the water temperature and display it.



## CHILLY GOAT BEHAVIOR

### PUMPS

Press JETS button once to turn the therapy pump on or off. If left running, the pump will turn off after a time-out period.

### CIRCULATION PUMP

The Chilly GOAT Valaris hot tub portion is equipped with a circulation pump, it will be configured to work as a programmable circulation pump.

A programmable circulation pump will come on when the system is checking temperature

## TP500S CONTROL SYSTEM CONT.

(polling), during filter cycles, during freeze conditions, or when another pump is on.

### FILTRATION AND UV

With dedicated circulation systems, the UV will run in combination with the circulation pump.

The system is factory-programmed with a single filter cycle that will run 10 minutes after power-up. The filter duration is programmable.

At the start the filter cycle the therapy pump will run briefly to purge its plumbing to maintain good water quality.

### FREEZE PROTECTION

If the temperature sensors within the heater detect a low enough temperature, then the pump(s) automatically activate to provide freeze protection. The pump(s) will run either continuously or periodically depending on conditions. If the temperature sensors detect a drop to below 44°F (6.7°C) within the heater, the pump will automatically activate to provide freeze protection. The equipment stays on until 4 minutes after the sensors detect that

the Chilly GOAT™ temperature has risen to 45°F (7.2°C) or higher. During freeze protection the heater will not be activated.

### ADJUSTING THE SET TEMPERATURE

When using a panel with Up and Down buttons (Temperature buttons), pressing UP or DOWN will cause the temperature to flash. Pressing a temperature button again will adjust the set temperature in the direction indicated on the button. When the LCD stops flashing, the Chilly GOAT will heat to the new set temperature when required.

The water temperature can be set between 80°F (27°C) and 104°F (40°C). Consider that the comfortable temperature range during use may be lower than the maximum safe temperature. Check the set water temperature and consider lowering it for the times when the Chilly GOAT will typically not be in use.

### PRESS-AND-HOLD

If a temperature button is pressed, WARM (Up), COOL (Down) or single TEMP; and held when the temperature is flashing, the temperature will continue to change until the button is released.

## MODE - READY & REST

In order for the Chilly GOAT to heat, a pump needs to circulate water through the heater. The pump that performs this function is known as the “heater pump.”

The heater pump on the Chilly GOAT Valaris is the circulation pump.

The circulation pump in Ready mode (indicated by **R**) will circulate the water periodically. This will maintain a constant water temperature,

heat as needed, and refresh the temperature display. This is know as “polling.”

### REST MODE

Rest Mode (indicated by **R**) will only allow heating during programmed filter cycles. Since polling does not occur, the temperature display may not show a current temperature until the circulation pump has been running for a minute or two. Using rest mode is not recommended in below freezing temperatures

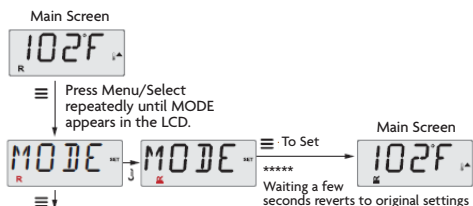

To next item in Main Menu if not toggled

Toggle between Ready (indicated by **R**) and Rest (indicated by **R**)

Pressing Menu/Select when the display is toggled will go to Main Screen.

Ready Mode will allow the Chilly GOAT to Poll and determine a need for heat. The panel will maintain a “current” temperature display.

Ready Mode will not allow Poll and will only heat during filter cycles. The panel will not display a current temperature at all times.



The Main Screen will display RUN PUMP FOR TEMP if the primary pump has not run for over 1 hour. The Main Screen will display normally during Filter Cycle or when the spa is in use. If the primary pump has been off for an hour or more, when any function button, EXCEPT Light, is pressed on the panel, the pump used in conjunction with the heater will run so that temperature can be sensed and displayed.

### Key

- Indicates Flashing or Changing Segment
- Indicates Alternating or Progressive Message - every 1/2 second
- A temperature button, used for “Action”

Waiting time that keeps the last change to a menu item.

- \*\*\*\*\* Waiting time (depends on menu item) that reverts to original setting and ignores any change to that menu item.

## READY-IN-REST MODE

READY/REST **R** appears in the display if the Chilly GOAT™ is in Rest Mode and “Jets” is pressed. It is assumed that the Chilly GOAT™ is being used and will turn on the heater to try heating to the set temperature. The primary pump will run until set temperature is reached, or 1 hour has passed. After 1 hour, the System will revert to Rest Mode. This mode can also be reset by entering the Mode Menu and changing the Mode.

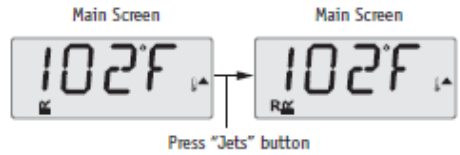

## FLIP (INVERT DISPLAY)

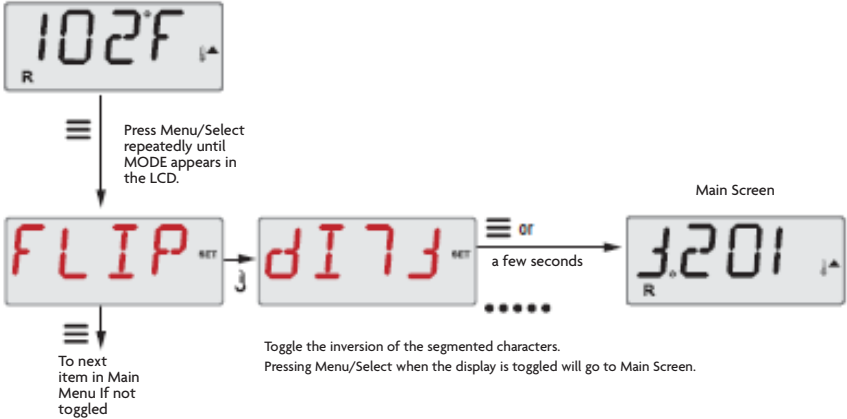

## ADJUSTING FILTRATION

### MAIN FILTRATION

Filter cycles are set using a duration. Each setting can be adjusted in 1 hour increments. The default time is 4:30. The filter cycle will start a few minutes after the Chilly GOAT™ is powered up.

### Key

- Indicates Flashing or Changing Segment
- Indicates Alternating or Progressive Message - every 1/2 second
- A temperature button, used for “Action”

Waiting time that keeps the last change to a menu item.

\*\*\*\*\* Waiting time (depends on menu item) that reverts to original setting and ignores any change to that menu item.

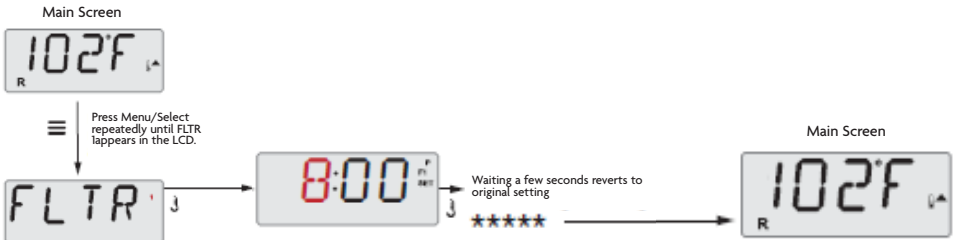

# TP500S CONTROL SYSTEM CONT. - GENERAL MESSAGES

## PURGE CYCLES

In order to maintain sanitary conditions, secondary Pumps will purge water from their respective plumbing by running briefly at the beginning of each filter cycle.

## PRIMING MODE

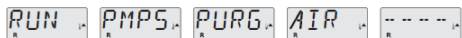

Each time the Chilly GOAT is powered up, it will enter Priming Mode. The purpose of Priming Mode is to allow the user to run each pump and manually verify that the pumps are primed (air is purged) and water is flowing. This typically requires observing the output of each pump separately and is generally not possible in normal operation. The Priming Mode lasts 4 minutes, but you can exit it earlier by pressing any Temp button. The heater is not allowed to run during Priming Mode.

**NOTE:** The circulation pump will turn on with the Jets in Priming Mode. The dedicated Circulation Pump will run by itself when Priming Mode is exited.

## WATER TEMPERATURE IS UNKNOWN



After the pump has been running for 1 minute, the temperature will be displayed.

## TOO COLD - FREEZE PROTECTION

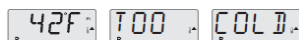

A potential freeze condition has been detected, or the Aux Freeze Switch has closed, and all pumps are activated, either one at a time, or all at once, depending on how your system was built. All pumps are ON for at least 4 minutes after the potential freeze condition has ended, or when the aux freeze switch opens.

In some cases, pumps may turn on and off and the heater may operate during Freeze Protection.

This is an operational message, not an error indication.

## WATER IS TOO HOT



One of the water temp sensors has detected Chilly GOAT™ water temp 110°F (43.3°C) and Chilly GOAT functions are disabled. System will auto reset when the Chilly GOAT water temp is

below 108°F (42.2°C). Check for extended pump operation or high ambient temp.

## J29 WARNING

J29 is typically used as a Heater Disable input. As such, it should not typically be shorted at power-up. This message appears if J29 is shorted at power-up.

## HEATER FLOW IS REDUCED (HFL)



There may not be enough water flow through the heater to carry the heat away from the heating element. Heater start-up will begin again after about 1 min. See "Flow Related Checks" below.

## HEATER FLOW IS REDUCED (LF)\*



There is not enough water flow through the heater to carry the heat away from the heating element and the heater has been disabled. See "Flow Related Checks" below. After the problem has been resolved, you must press any button to reset and begin heater start up.

## HEATER MAY BE DRY (DR)\*

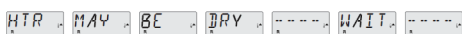

Possible dry heater, or not enough water in the heater to start it. The Chilly GOAT™ is shut down for 15 min. Press any button to reset the heater start-up. See "Flow Related Checks" below.

## HEATER IS DRY\*

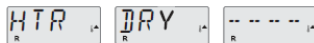

There is not enough water in the heater to start it. The Chilly GOAT is shut down. After the problem has been resolved, you must press any button to reset and restart heater start up. See "Flow Related Checks" below.

## HEATER IS TOO HOT (OHH)\*



One of the water temp sensors has detected 118°F (47.8°C) in the heater and the Chilly GOAT is shut down. You must press any button to reset when water is below 108°F (42.2°C). See "Flow Related Checks" below.



## A RESET MESSAGE MAY APPEAR WITH OTHER MESSAGES

PRES. BTTN. TO RSET. -----

Some errors may require power to be removed and restored.

## FLOW-RELATED CHECKS

Check filters for possible blockage. Try cleaning or replacing filters (especially if the Chilly GOAT is equipped with 24-hour circulation pump). Check for low water level, suction flow restrictions (i.e. any leaves or debris pulled against suction fittings in bottom of Chilly GOAT shell), closed valves, too many closed jets and pump prime/air locked pump (see Initial Chilly GOAT Setup section for instructions on relieving pump air lock). On some systems, even when the Chilly GOAT is shut down by an error condition, some equipment may occasionally turn on to continue monitoring the temperature or if freeze protection is needed.

## SENSOR BALANCE IS POOR

102F. SNSR. BAL. ANCE

The temperature sensors MAY be out of sync by 2°F or 3°F. Contact your Master Spas dealer or service organization.

## SENSOR BALANCE IS POOR\*

SNSR. SYNC. ----- CALL. FOR. SRVC. -----

The temperature sensors failed to balance and have remained out of sync for more than 1 hour. Contact your Master Spas dealer or service organization.

## SENSOR FAILURE - SENSOR A, SENSOR B

SNSR. A. ----- CALL. FOR. SRVC. -----  
B

A temperature sensor or sensor circuit has failed. Contact your Master Spas dealer or service organization.

## NO COMMUNICATIONS

NO COMM

The control panel is not receiving communication from the System. Contact your Master Spas dealer or service organization.

## °F OR °C IS REPLACED BY °T

102T

The Control System is in Test Mode. Contact your Master Spas dealer or service organization.

## MEMORY FAILURE - CHECKSUM ERROR\*

MEM. FAIL. -----

At power up, the system has failed the Program Checksum Test. This indicates a problem with the firmware (operation program). Contact your Master Spas dealer or service organization.

## MEMORY WARNING - PERSISTENT MEMORY RESET\*

MEM. RSET. -----

Appears after any system setup change. Contact your Master Spas dealer or service organization if this message appears on more than one power up, or if it appears after the system has been running normally for a period of time.

## MEMORY FAILURE - CLOCK ERROR\*

CLOCK. FAIL. -----

Contact your Master Spas dealer or service organization.

## CONFIGURATION ERROR – CHILLY GOAT™ WILL NOT START UP

CNFG. FAIL. ----- CALL. FOR. SRVC. -----

Contact your Master Spas dealer or service organization.

## GFCI FAILURE - SYSTEM COULD NOT TEST/TRIP THE GFCI

GFCI. FAIL. -----

NORTH AMERICA ONLY. May indicate an unsafe installation. Contact your dealer, service organization, or electrician.

## A PUMP APPEARS TO BE STUCK ON

STUCK. PUMP. -----

Water may be overheated. POWER DOWN THE CHILLY GOAT. DO NOT ENTER THE WATER. Contact your Master Spas dealer or service organization.

## A PUMP APPEARS TO HAVE BEEN STUCK ON WHEN CHILLY GOAT WAS LAST POWERED

HOT. FALT. ----- CALL. FOR. SRVC. -----

POWER DOWN THE CHILLY GOAT. DO NOT ENTER THE WATER. Contact your Master as dealer or service organization.

## THE WATER LEVEL IS TOO LOW

WATR. LEVL

Some systems have a water level detect, and this message appears if it detects that the water level is too low.

\* This message can be reset from the topside control panel by pressing any button.

# LIMITED WARRANTY

## MICHAEL PHELPS CHILLY GOAT™ VALARIS COLD TUB BY MASTER SPAS

**NOTE:** This Standard Limited Warranty applies to residential use within the United States and Canada.

### 2 YEARS - SHELL STRUCTURE

Master Spas warrants to the original retail purchaser that the Chilly GOAT Valaris shell structure manufactured by Master Spas will not leak water due to defects in material or workmanship in the cold tub shell structure for a period of 2 years from the date of the original retail purchase. Master Spas will either provide parts or materials to repair (parts only coverage) or replace the nonconforming cold tub shell structure. In the event of replacement, the cost of labor and equipment for removal and replacement of the unit is the sole responsibility of the Purchaser.

### 2 YEARS - SHELL SURFACE

Master Spas warrants to the original retail purchaser that the acrylic finish will not blister, crack, or delaminate, for a period of 2 years from the date of original retail purchase resulting from defects in material or workmanship. Master Spas will replace the nonconforming shell (parts only coverage). In the event of replacement, the cost of labor and equipment for removal and replacement of the unit is the sole responsibility of the Purchaser. There is no Shell Surface warranty on blemished units. (Spider cracking in the acrylic is not a defect).

### 1 YEAR - EQUIPMENT

Master Spas warrants to the original retail purchaser the Chilly GOAT Valaris equipment, (control system, control panel, heater, circulation pump, and heat pump) should a component of the Equipment fail or malfunction due to defects in material and workmanship for a period of 1 year from the date of the original retail purchase. If a component of the Equipment fails or malfunctions due to a defect in material or workmanship, Master Spas will provide replacement parts to repair or replace the applicable components (parts only).

### 1 YEAR - PLUMBING & WALL FITTINGS

Master Spas warrants to the original retail purchaser for a period of 1 year from the date

of original retail purchase that the plumbing and wall fittings of the Chilly GOAT Valaris will not leak due to defects in material and workmanship. If the plumbing and wall fitting components leak due to a defect in material or workmanship, Master Spas will provide replacement parts to repair or replace the applicable components (parts only).

### 1 YEAR - LED LIGHT SYSTEM

Master Spas warrants to the original retail purchaser, for a period of 1 year from the date of original retail purchase that the optional, factory installed LED light system will not malfunction due to defects in workmanship and materials (parts only). If the LED light system or any component thereof fails due to defects in material or workmanship, Master Spas will replace the applicable components (parts only).

### 1 YEAR - UV SYSTEM

Master Spas warrants to the original retail purchaser that the factory installed UV system will not malfunction due to defects in materials or workmanship for a period of 1 year from the date of original retail purchase. If the UV system malfunctions due to a defect in materials or workmanship, Master Spas will replace the applicable components (parts only).

### 1 YEAR - NONSLIP, COMFORT FLOOR SYSTEM

Master Spas warrants to the original retail purchaser that the factory installed Nonslip, Comfort Floor System will not separate from the floor of the Chilly GOAT Valaris for a period of 1 year (parts only). In the event the adhesion fails causing the pad to come free from the cold tub shell or separation of the pad material occurs; Master Spas will replace the applicable component(s), parts only. Normal discoloring, fading, or wear of the Nonslip, Comfort Floor System is not covered by this limited warranty. Causes of these failures include but are not limited to water conditions, chemical levels or UV exposure. See the owner's manual for proper water chemistry levels, water maintenance and Chilly GOAT care for best longevity of your Nonslip, Comfort Floor System. Damage such as cuts, gouges and scrapes caused to the pad from objects would not be covered by this limited warranty.

### EXCLUSIONS

This limited warranty is enforceable only by the original retail purchaser from the date of original retail purchase but is voidable if the entire purchase price has not been paid.

# LIMITED WARRANTY

## EXCLUSION AND LIMITATIONS

Light bulbs, light lenses, fuses, covers, pillows or any aftermarket installed accessories are specifically excluded from this limited warranty. All warranties are void if the Chilly GOAT™ is placed in commercial service unless purchaser has selected the commercial business warranty upgrade at time of purchase. Normal wear and weathering of finishes and components are not defects and specifically excluded from this limited warranty. The cabinet panels are only warranted to be free from defects or damage at the time of delivery. In the event it is necessary to remove the Chilly GOAT™ from the residential premises to repair or replace any warrantable item, any and all cost of Chilly GOAT removal and replacement including but not limited to removal of the original Chilly GOAT and transportation of the replacement Chilly GOAT, damages to landscaping, decking, fencing or other structural alteration, or any cost related to obtaining access to the Chilly GOAT are specifically excluded and are the sole responsibility of the purchaser. Chilly GOAT covers are not included or covered by this limited warranty.

## LIMITATIONS

This limited warranty is voidable if the Chilly GOAT has been subject to misuse, alteration or attempted alteration, repairs or attempted repairs, not approved by Master Spas, or if a failure or malfunction is due to improper installation, improper water chemistry, improper maintenance or lack of normal maintenance as prescribed in the Master Spas Owner's Manual, an act of God, weather conditions, animals, rodents, pests or any damage from causes beyond the control of Master Spas. Misuse or abuse shall mean operation of the Chilly GOAT other than in conformity with the Master Spas Owner's Manual. Such misuse and abuse shall include but not be limited to the following:

- Damage of the Chilly GOAT surface and components caused by leaving the Chilly GOAT uncovered or due to covering the Chilly GOAT with plastic film of any kind.
- Damage to the Chilly GOAT surface and components caused by use of a non-insulating cover or an unapproved cover not manufactured by Master Spas when the

Chilly GOAT is subject to weather conditions and sun.

- Damage to the Chilly GOAT surface and components caused by contact with unapproved cleaners or solvents.
- Damage caused by operation of the Chilly GOAT at water temperatures outside the range of recommended in the owner's manual.
- Freeze damage.
- Damage caused by unapproved sanitizers such as calcium hypochlorite, sodium hydroxide, "tri-chlor" type chlorines or any sanitizing chemical that may remain undissolved on the Chilly GOAT surface.
- Damages or malfunction due to a dirty, clogged, calcified filters or use of an unapproved filter cartridge.
- Damages or malfunction caused by failure to provide even, proper support for the Chilly GOAT.
- Damages or malfunction caused during installation of the Chilly GOAT.
- Damages or malfunction caused by use of unapproved filter cartridges.
- Damages or malfunction caused due to moving the Chilly GOAT to a different location from its original installation.

## WARRANTY REGISTRATION AND WARRANTY CLAIM PROCEDURE

The original purchaser should register their Chilly GOAT purchase within 10 days from the date of original retail purchase to establish proof of purchase with Master Spas. Failure to register does not void this limited warranty but, upon any warranty claim, proof of purchase must first be provided to confirm the original retail purchase date to the original retail purchaser. Chilly GOAT Registration can be submitted online at [masterspas.com/resources](http://masterspas.com/resources). In the event of a warranty claim of a defect or malfunction covered under the provisions of this limited warranty, the original retail purchaser must notify in writing the retail dealer or Master Spas Customer Service department within ten (10) days of the initial malfunction or discovery of defect. If the retail dealer does not provide support, then the purchaser should contact Master Spas Customer Service department, via the web site, or provide written notice of the malfunction or defect at the address below. Upon notice of

# LIMITED WARRANTY

## EXCLUSION AND LIMITATIONS

the warranty claim, the retail dealer or Master Spas Customer Service department will work with the retail purchaser to troubleshoot and determine if the claimed malfunction or defect is a covered malfunction or defect under this limited warranty. This limited warranty covers parts to repair or replace applicable components. If the retail purchaser does not feel comfortable with, knowledgeable or skilled to troubleshoot or make repairs, the retail purchaser should find and hire a local contractor (such as a local licensed electrician or HVAC technician) to assist them. In the event the retail purchaser does so, a copy of the repair invoice may be submitted to Master Spas Customer Service Department for consideration of up to \$125.00USD labor reimbursement (lesser of either the invoiced labor or up \$125.00 maximum) per claimed problem(s) case. The arrangements made with 3rd party, local contractor is sole responsibility of the purchaser and made between the purchaser and their chosen 3rd party contact. Master Spas will assist with troubleshooting and provide applicable parts/components per the terms defined in this limited warranty. Repeat trips, made by a hired service contact, that may occur, will only be considered for reimbursed as 1 overall claim per problem case (lesser or maximum of \$125 per claim case). If it is determined that the malfunction is not covered by this limited warranty, the cost of the service, that the purchaser arranged and paid 3rd party, and any component(s) shipped by Master Spas would be the sole responsibility of the purchaser. If it is determined that the malfunction or defect is covered under this limited warranty, Master Spas will cover the applicable replacement components/items. In the event of Chilly GOAT™ replacement, the replacement Chilly GOAT will carry the balance of the original Chilly GOAT limited warranty from the original retail purchase date. In addition, access charges will be assessed if the Chilly GOAT is not reasonably accessible for inspection, repair or replacement. This limited warranty is extended only to the original retail purchaser and is not transferable. This limited warranty becomes void upon the transfer of ownership of the Chilly GOAT or moving of the Chilly GOAT to a different location, outside the country of original purchase.

**NOTICE: ANY DAMAGE TO THE CHILLY GOAT CAUSED FROM MOVING THE CHILLY GOAT IS EXCLUDED FROM THIS LIMITED WARRANTY.**

**DISCLAIMERS:** MASTER SPAS LLC, NEITHER ASSUMES NOR DO WE AUTHORIZE ANY OTHER PERSON TO ASSUME FOR US, ANY OTHER LIABILITY IN CONNECTION WITH THE SALE OF CHILLY GOATS MANUFACTURED BY MASTER SPAS. THIS LIMITED WARRANTY SHALL BE THE EXCLUSIVE REMEDY AVAILABLE TO A PURCHASER AND MASTER SPAS SHALL NOT BE LIABLE FOR ANY INCIDENTAL OR CONSEQUENTIAL DAMAGES RESULTING FROM MISUSE OF THE CHILLY GOAT OR CAUSED BY ANY DEFECT, FAILURE OR MALFUNCTION OF THE CHILLY GOAT, WHETHER A CLAIM IS BASED UPON WARRANTY, CONTRACT, NEGLIGENCE OR OTHERWISE. SOME STATES DO NOT ALLOW THE EXCLUSION OF INCIDENTAL OR CONSEQUENTIAL DAMAGES, SO THIS LIMITATION MAY NOT APPLY TO YOU.

TO THE EXTENT PERMITTED BY APPLICABLE LAW, THIS LIMITED WARRANTY SPECIFICALLY EXCLUDES ANY AND ALL IMPLIED WARRANTIES OF MERCHANTABILITY AND/OR FITNESS FOR A PARTICULAR PURPOSE, OTHERWISE ALL IMPLIED WARRANTIES ARE LIMITED IN DURATION TO TWO (2) YEARS FROM THE ORIGINAL DATE OF RETAIL PURCHASE. SOME STATES DO NOT ALLOW THE LIMITATION OF THE DURATION OF IMPLIED WARRANTIES. SO THIS LIMITATION MAY NOT APPLY TO YOU. THERE ARE

NO OTHER WARRANTIES, EITHER EXPRESSED OR IMPLIED, OF ANY KIND OR NATURE WHICH EXTEND BEYOND THE DESCRIPTION ON THE FACE HEREOF. SOME STATES DO NOT ALLOW THE LIMITATIONS OF REMEDIES SO THESE LIMITATIONS MAY NOT APPLY TO YOU.

**If your Chilly GOAT is designated by Master Spas and/or purchased as a “blem”, “blemished”, or “refurbished” model, the Chilly GOAT is sold “as-is” with regards to cosmetic appearances and will have no Shell Surface warranty of the Chilly GOAT. Other sections of the warranty including shell structure, equipment, and noted parts, remains in full as outlined above.**

# COLD TUB CARE AND MAINTENANCE RECORD

## MAINTENANCE AVERAGE TIMETABLES

Below is a list of routine maintenance and the guidelines on how often they should be done. The frequency in which these actions should be performed may vary depending on bather load and how often you use your Chilly GOAT™.

- Test GFCI - Before each use
- Clean Filter Cartridge - at least once a month

- Clean and Condition Cover - twice a month
- Drain and Clean Chilly GOAT: every 6 months or as needed

## MAINTENANCE LOG

Use the following lines to document your Chilly GOAT tub care and maintenance.

### MAINTENANCE PERFORMED

### DATE DATE DATE

MAINTENANCE PERFORMED	DATE	DATE	DATE





TM

**SCAN QR CODE TO  
ACCESS  
HOW-TO-VIDEOS**



Master Spas®

6927 Lincoln Parkway, Fort Wayne, IN 46804

877-ChillyGOAT

Customer Service: [GOATtech@ChillyGOATtubs.com](mailto:GOATtech@ChillyGOATtubs.com)

[ChillyGOATtubs.com](http://ChillyGOATtubs.com)

Stay Connected, Keep in Touch



Master Spas® reserves the right to change product specifications or features without notice. Master Spas is a manufacturer of spas and related products, and we stand behind every product we produce pursuant to those representations which are stated in our written limited warranty. Your dealer is an independent businessperson or company and not an employee or agent of Master Spas, LLC. We cannot and do not accept any responsibility or liability for any other representations, statements or contracts made by any dealer beyond the provisions of our written limited warranty. Apple is a trademark of Apple Inc., registered in the U.S. and other countries. Google Play is a trademark of Google, LLC. Master Spas is a registered trademark of Master Spas, LLC.