

NOZZLE SCHEDULE								
ITEM	SIZE	RATING	TYPE	MATL	PROJ. IN	PROJ. OUT	REMARKS	NOTES
A	4"	N.P.T.	W.F.	C.S.	STD.	STD.	EMERGENCY VENT OPENING	-
B	2"	N.P.T.	W.F.	C.S.	STD.	STD.	-	-

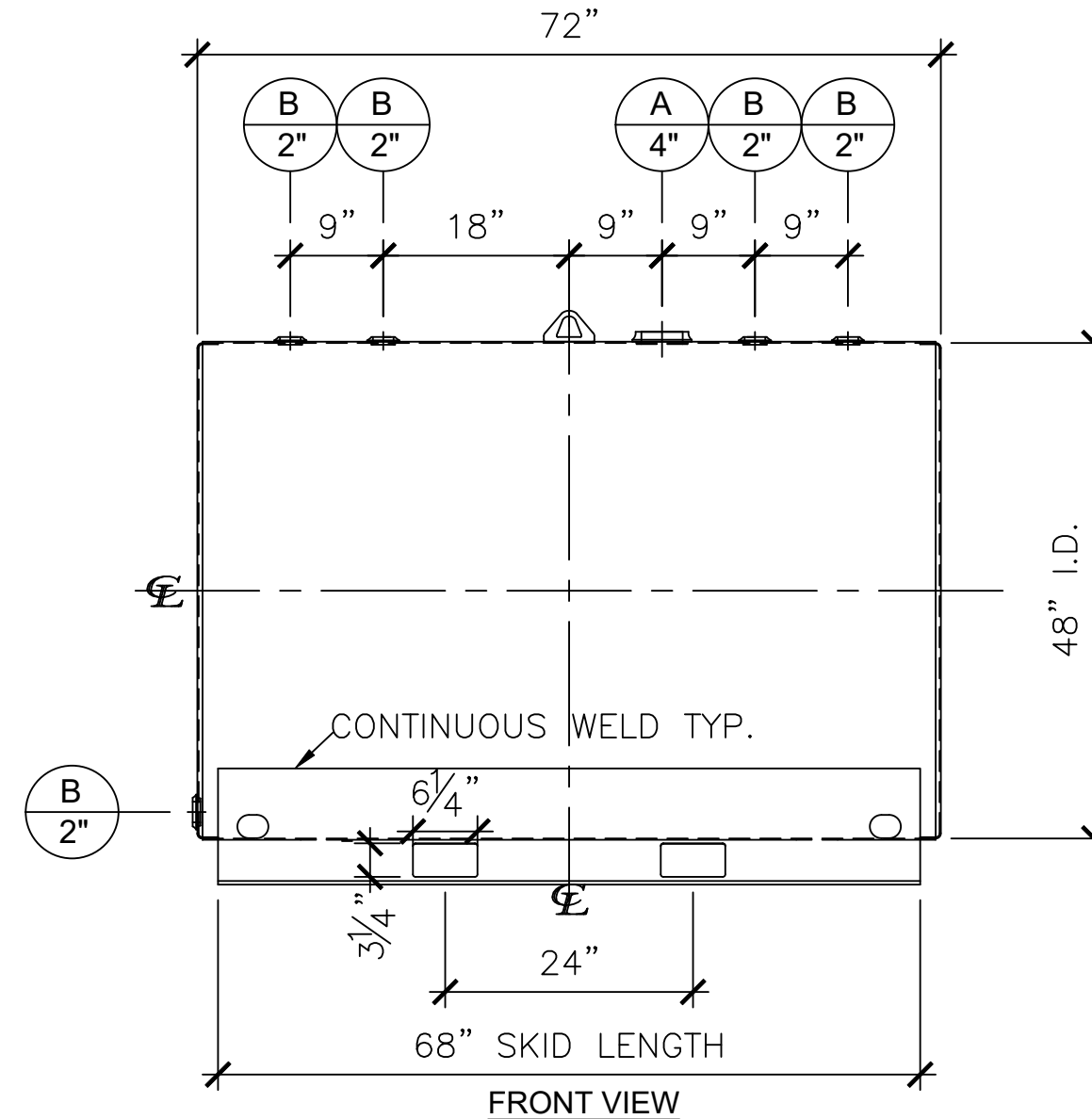
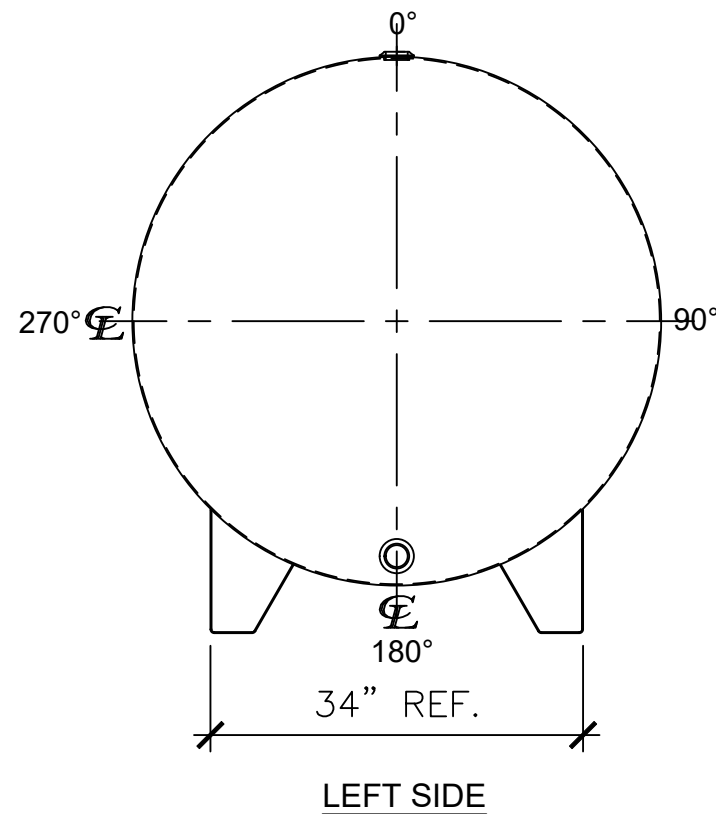

NOTES:

- A. Quantity:
- B. Material: H.R. Carbon Steel.
- C. Design Pressure: Atmospheric.
- D. Design Temperature: Ambient.
- E. Built & labeled per U.L. spec. #142.
- F. Exterior: Gray primer included; see Sales Order for top coat.
- G. All fittings to be protected for shipment.
- H. Customer to verify nozzle sizes, locations and quantities.
- I. Saddles/skids may require shimming or grouting during installation.

*All pages of this Schedule A are incorporated by reference and are a part of the additional terms of the Master Terms & Conditions of Sale.
www.newberrytanks.com/masterterms.pdf

APPROVAL FOR CONSTRUCTION
 SCHEDULE A - MASTER TERMS & CONDITIONS OF SALE*

APPROVED AS DRAWN.

APPROVED WITH NOTED CHANGES, CONSTRUCTION WILL BE SCHEDULED WHEN SIGNED DRAWING AND CONFIRMED ORDER ARE RECEIVED.

SIGNATURE: _____

DATE: _____

SALES ORDER#

 Phone: 870-735-4473 Fax: 870-735-3982

VESSEL DESCRIPTION:
 550 Gallon 48" I.D. x 6'-0" O.A.L. Single Wall Skid Tank

CUSTOMER: _____ P.O.# _____

DATE: _____ SCALE: _____ DWG.# NB00550SWS04812G DRAWN BY: TC

CHKD. BY: _____

This drawing may contain CONFIDENTIAL information and is intended only for the use of the specific individual(s) to which it is addressed.