

# PBA series

Piezo switches Ø 16 mm



## DISTINCTIVE FEATURES

Bushing diameter 16 (.630), 19 (.748), 22 (.866) or 30 mm (1.181)

Sealed to IP68 and IP69K (switches mounted on panel)

Easy to clean metal surface

Very long life expectancy

Ring illumination



## ENVIRONMENTAL SPECIFICATIONS

- Sealing : IP68 per IEC 60529, IP69K per DIN 40050-9 (switches mounted on panel)
- Vibration resistance : 10-500 Hz / 10 g per IEC 60068-2-6
- Operating temperature : -40 °C to +75 °C (-40 °F to + 167 °F)
- EMC compatibility according to EN 61058-1 for the whole range
- EMC compatibility according to EN 61000-4 & EN61000-6-2 for model 1A (code 002)
- Extreme thermal shock may briefly trigger the switch



## ELECTRICAL SPECIFICATIONS

- Max. current/voltage rating with resistive load :
  - Function A : standard 200 mA 24 VAC/DC - option 1 A 24 VAC/DC
  - Function B : standard 100 mA 24 VAC/DC
- Switch resistance ON : 10 Ω max.
- Switch resistance OFF : 5 MΩ min.
- Life expectancy : 50 million cycles
- LED consumption : 20 mA max. (functions A-B)
- Power consumption for function 1 :
  - non-illuminated 10 mA - illuminated 30 mA



## GENERAL SPECIFICATIONS

- Operating force : 2 to 6 N
- Torque : 2.5 Nm min. - 3 Nm max.

The company reserves the right to change specifications without notice.

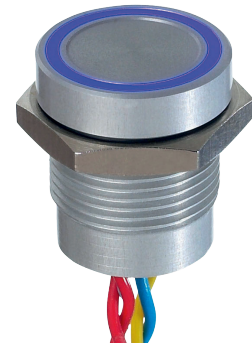

# PBA series

Piezo switches Ø 16 mm



## MATERIALS

- Case : aluminum, anodized or stainless steel 316L
- Multi-wire leads section 0.22 mm<sup>2</sup> length 300 mm, twisted by pair
- Cable, length 300 mm, section depending on switch model
- PC terminals : bronze, tin plated

APEM products may be recycled at end-of-life for the re-claiming of valuable metal components.

**Note :** to maintain the ESD performance, always add a ground washer when the panel is made of non-conductive material (PVC, polycarbonate).  
For part numbers, see "Mounting accessories" on the following pages.



## SEALING

### SEALING IP68

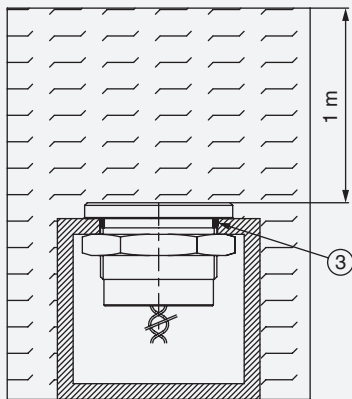

**Continuous immersion in water  
IP68 test conditions**  
Continuous immersion in water  
(1 m, 24 hours)

### SEALING IP69K

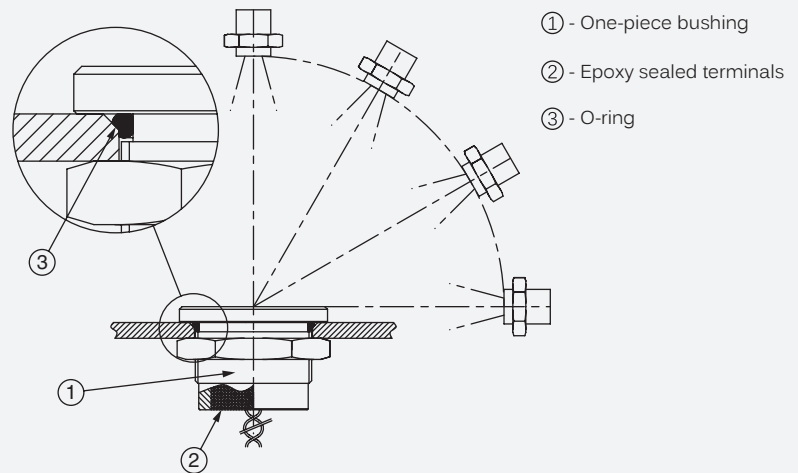

**High pressure, high temperature wash down  
IP69K test conditions**

- . Pressure : 80 - 120 bars
- . Distance : 15 cm
- . Temperature : 80 °C ± 5 °C (176 °F ± 41 °F)
- . Flow : 14 - 16 l/mn
- . Duration : 30 seconds per position



## PANEL CUT-OUT

MODELS Ø16 (.630)

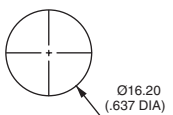



## ELECTRICAL FUNCTIONS

FINGER PRESSURE APPLIED TO SWITCH

1 : pressure / 0 : no pressure

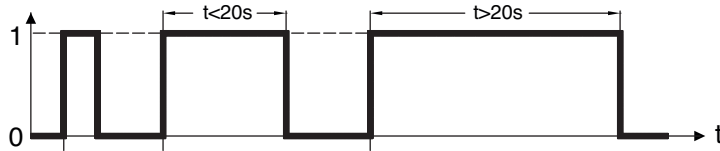

OUTPUT

1 : closed output / 0 : open output

Momentary NO (pulse)

No external power supply required

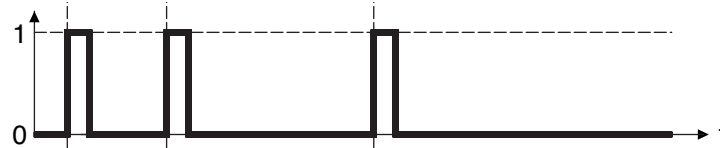

Momentary NC (pulse)

No external power supply required

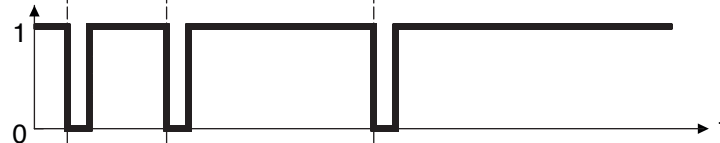

Latching (ON - OFF)

Requires external power supply

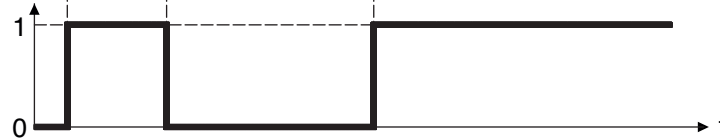

## WIRING DIAGRAMS

	Non-illuminated	1 LED *	2 LEDs	3 LEDs
Momentary NO				
Momentary NC				
Latching (ON - OFF)				

Legend : C : yellow, D : blue, B : black , A : same color as LED

\* LED color is indicated by protective resin color on bottom of unit.

# PBA series

Piezo switches Ø 16 mm

## BUILD YOUR PART NUMBER

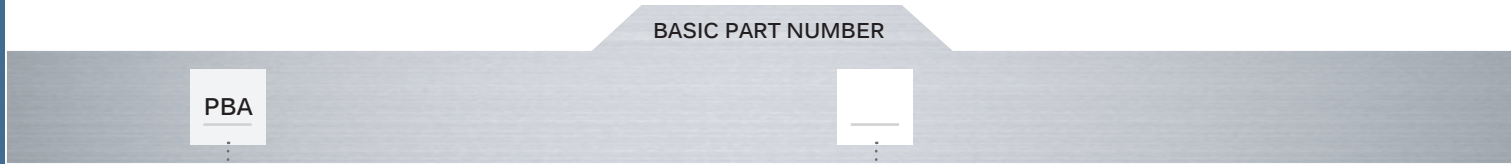

SERIES

BUSHINGS / OPERATORS

<b>R1</b>	Flat operator, height 4.50 (.177)
<b>T5</b>	Flat operator, height 1 (.039) (non illuminated)
<b>R5</b>	Operator with finger location, height 4.50 (.177) (non-illuminated)

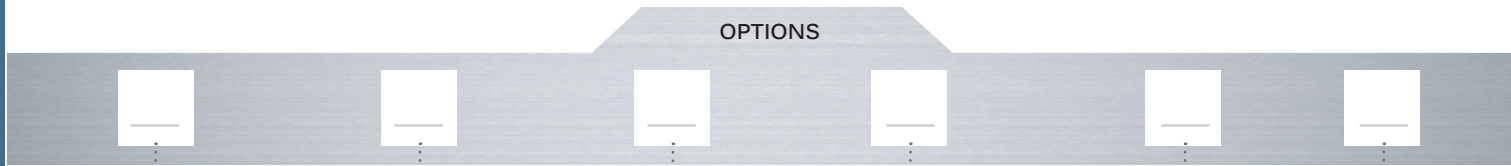

ELECTRICAL FUNCTIONS

TERMINALS

COLORS / MATERIALS

RATINGS

TYPE OF ILLUMINATION/  
VOLTAGE

<b>A</b>	NO (pulse)
<b>B</b>	NC (pulse)
<b>1</b>	ON - OFF (requires external power supply - cannot be combined with T5 operator - illumination type W only)

<b>F</b>	Flying leads
<b>C</b>	Cable
<b>P</b>	Straight PC (T5 model, non-illuminated, functions A & B only)

<b>0</b>	<b>Natural anodized</b>
<b>1</b>	Blue anodized
<b>2</b>	<b>Black anodized</b>
<b>3</b>	Green anodized
<b>5</b>	Gold anodized
<b>6</b>	Red anodized
<b>B</b>	<b>Stainless steel 316L</b>

<b>000</b>	Standard
<b>002</b>	1 A 24 VAC/DC (NO pulse only, function A)

<b>Blank</b>	Non-illuminated
<b>A</b>	Standard ring - 5 VDC
<b>N</b>	Standard ring - 12 VDC
<b>K</b>	Standard ring - 24 VDC
<b>W</b>	Standard ring, microcontroller driven

Bold = standard

LED COLORS

LED COLORS (CONTINUED)

<b>Blank</b>	Non-illum.
<b>0B</b>	Blue
<b>0G</b>	Green
<b>0S</b>	Red
<b>0Y</b>	Yellow
<b>0W</b>	White

<b>2A</b>	Red/green
<b>2B</b>	Red/yellow
<b>2C</b>	Red/blue
<b>2D</b>	Red/white
<b>2E</b>	Green/blue
<b>2F</b>	Green/yellow

<b>2G</b>	Green/white
<b>2H</b>	Blue/yellow
<b>2I</b>	Blue/white
<b>2K</b>	Yellow/white

<b>3A</b>	Red/green/blue
<b>3B</b>	Red/green/yellow
<b>3D</b>	Red/green/white
<b>3E</b>	Red/blue/yellow
<b>3F</b>	Red/blue/white
<b>3G</b>	Red/yellow/white

<b>3H</b>	Green/blue/yellow
<b>3I</b>	Green/blue/white
<b>3J</b>	Green/yellow/white
<b>3K</b>	Blue/yellow/white

For options not listed above, please contact APEM.

## ABOUT THIS SERIES

On the following pages, you will find successively basic part numbers of switches and options in the same order as in above chart.

 **Notice** : please note that not all combinations of above numbers are available. Refer to the following pages for further information.

 **Mounting accessories** : standard hardware supplied : 1 hex nut and 1 O-ring.  
Always add a ground washer U5735 (Ø16 mm) when the panel is non-conductive (PVC, polycarbonate).

# PBA series

Piezo switches Ø 16 mm

Ø16 (.630) - NON-ILLUMINATED  
OPERATOR HEIGHT 4.50 MM



Flat

PBAR1

With finger location

PBAR5

Ø16 (.630) - NON-ILLUMINATED  
OPERATOR HEIGHT 1 MM



Flat

PBAT5

Ø16 (.630) - STANDARD ILLUMINATED RING  
OPERATOR HEIGHT 4.5 MM

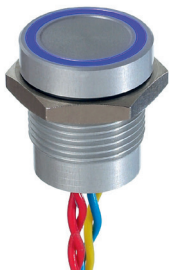

Flat

PBAR1

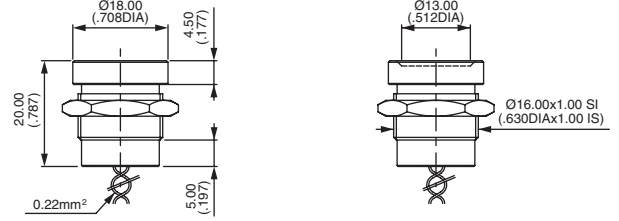

R1

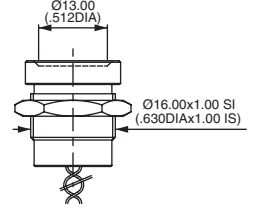

R5

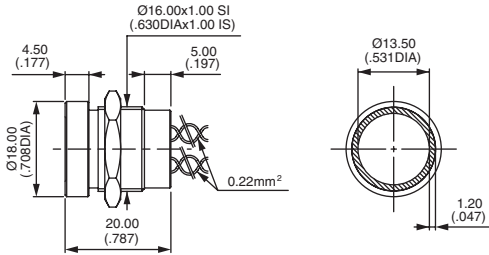
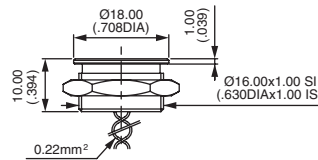

# PBA series

Piezo switches Ø 16 mm

## ELECTRICAL FUNCTIONS



- A NO pulse
- B NC pulse
- 1 ON - OFF - Requires external power supply - Cannot be combined with T5 operator - Illumination type W only.

## TERMINALS



- F Flying leads
- C Cable
- P Straight PC (T5 model, non-illuminated, functions A and B only)

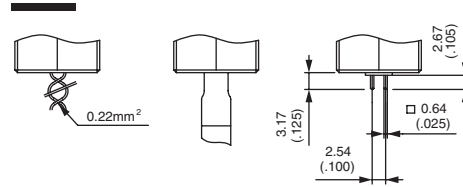

## CASE COLORS / MATERIALS



- 0 **Natural anodized aluminum**
- 1 Blue anodized aluminum
- 2 **Black anodised aluminum**
- 3 Green anodized aluminum
- 5 Gold anodized aluminum
- 6 Red anodised aluminum
- B **Stainless steel 316L**

Bold = standard



0 1 2 3 5 6 B

## RATINGS



- 000 Standard
- 002 1 A 24 VAC or DC (NO pulse only, function A)

# PBA series

Piezo switches Ø 16 mm

## TYPE OF ILLUMINATION / VOLTAGE

BASIC P/N



- Blank** Non-illuminated
- A** Thin ring - 5 VDC
- N** Thin ring - 12 VDC
- K** Thin ring - 24 VDC
- W** Thin ring -  $\mu$ controller driven

## LED COLORS

BASIC P/N

**Blank** Non-illuminated

Integrated LED resistor

### Illuminated 1 LED \*

**0B** : blue - **0G** : green - **0S** : red - **0Y** : yellow - **0W** : white

### Illuminated 2 LEDs

**2A** : red/green - **2B** : red/yellow - **2C** : red/blue - **2D** : red/white - **2E** : green/blue - **2F** : green/yellow - **2G** : green/white  
**2H** : blue/yellow - **2I** : blue/white - **2K** : yellow/white

### Illuminated 3 LEDs

**3A** : red/green/blue - **3B** : red/green/yellow - **3D** : red/green/white - **3E** : red/blue/yellow - **3F** : red/blue/white  
**3G** : red/yellow/white - **3H** : green/blue/yellow - **3I** : green/blue/white - **3J** : green/yellow/white - **3K** : blue/yellow/white

\* LED color is indicated by protective resin color on bottom of unit.



0B



0G



0S



0Y



0W