

HS series

Micro switch 5-way thumb controls •
switching technology



DISTINCTIVE FEATURES

- 2, 4 & 5-way (5-way with pushbutton option) operation
- Positive tactile feedback
- MOM-OFF-MOM
- Connectorized housing
- Several handle options available



ENVIRONMENTAL SPECIFICATIONS

- Operating Temperature: -25 °C to +80 °C (-13 °F to +176 °F)
- Storage Temperature: -30 °C to +85 °C (-22 °F to +185 °F)
- Above Panel Sealing: Up to IP67 & IP69K (subject to mounting style and final specifications)



ELECTRICAL SPECIFICATIONS

- Current Rating: Gold - 10 mA @ 30 VDC; Silver – 100 mA @ 30 VDC
- Insulation Resistance: Min 100 MΩ (250 VDC by insulation resistance meter)
- Voltage Withstand: 500 VAC for 1 minute
- Contact Resistance: Max 200 mΩ
- Electrical Function: Mom-off-mom



MECHANICAL SPECIFICATIONS

- Operating Force: 5.0 N ± 1.0 N (1.12 lbf ± 0.22 lbf)
- Maximum Vertical Load: 200 N (45 lbf)
- Maximum Horizontal Load: 150 N (33.7 lbf)
- Mechanical Angle of Movement: 30°
- Expected Life: 300,000 lifecycles
- Mass/Weight: 17g (0.60 oz) (Option HS1DXXXXA)
- Lever Action (centering): Spring

The company reserves the right to change specifications without notice.



HS series

Micro switch 5-way thumb controls • switching technology



MATERIALS

- Body: Glass filled nylon
- Handles:
 - 1, 2, 3 - Glass filled nylon
 - 4, 5, 6, 7, 8 - Silicone
 - B, C, D - Thermoplastic elastomer



PUSHBUTTON SWITCH (OPTION 6 HANDLE)

- Electrical Life: 100,000 cycles
- Rating: 50 mA, 12 VDC
- Terminal: Brass with silver plating
- Contact Resistance: 100 milliohms max.
- Insulation Resistance: 100 megohms min. 500 VDC
- Dielectric Strength: 250 VAC /1 minute
- Contact Arrangement: 1 pole 1 throw
- Operation Force: 1.5 lbf
- Stop Strength: Max 3 kgf vertical static load for 15 seconds
- Operating temperature: -25 °C to +70 °C (-13 °F to +158 °F)
- Storage Temperature: -30 °C to +85 °C (-22 °F to +185 °F)



CONNECTIONS

CONNECTOR POSITION	FUNCTION	WIRE HARNESS
1	Top Switch*	Orange
2	X+Switch	Blue
3	Y+Switch	Yellow
4	X-Switch	Blue/White
5	Y-Switch	Yellow/Black
6	Common	White
*Optional		

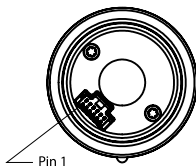

TERMINATION

- Manufacturer: Molex
- Manufacturer part number: 501331-0607
- Product range: Pico-Clasp™
- Circuits: Six
- Pitch: 1.00 mm
- Mating connector: Molex 501330-0600



MOUNTING

PLASTIC HOUSING - DROP-IN CUTOUT

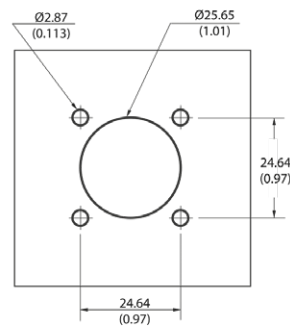

4 x PUSH IN CONNECTORS



- The under panel depth for the Drop-in configuration is 16.02 mm (0.631 in).

PLASTIC HOUSING - REAR MOUNT OPTION CUTOUT

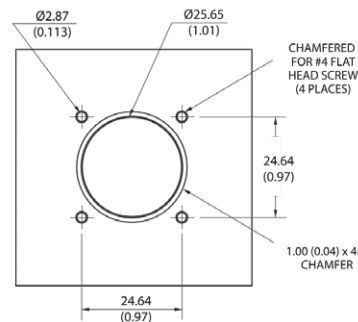

4 x 1/2 FH SS PHIL SCREW

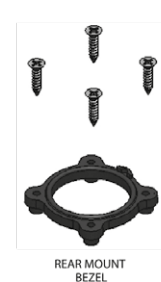

- The maximum panel thickness for the Rear Mount configuration is 2.032 mm (0.08 in).

METAL THREADED HOUSING - DROP-IN CUTOUT

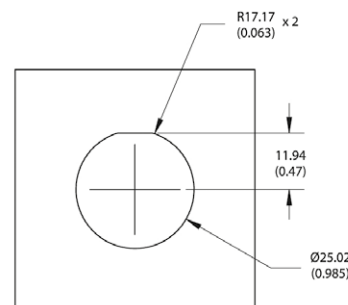

- The under panel depth for the Metal Threaded Housing configuration is 14.55 mm/(0.573 in).

HS series

Micro switch 5-way thumb controls • switching technology



BUILD YOUR PART NUMBER

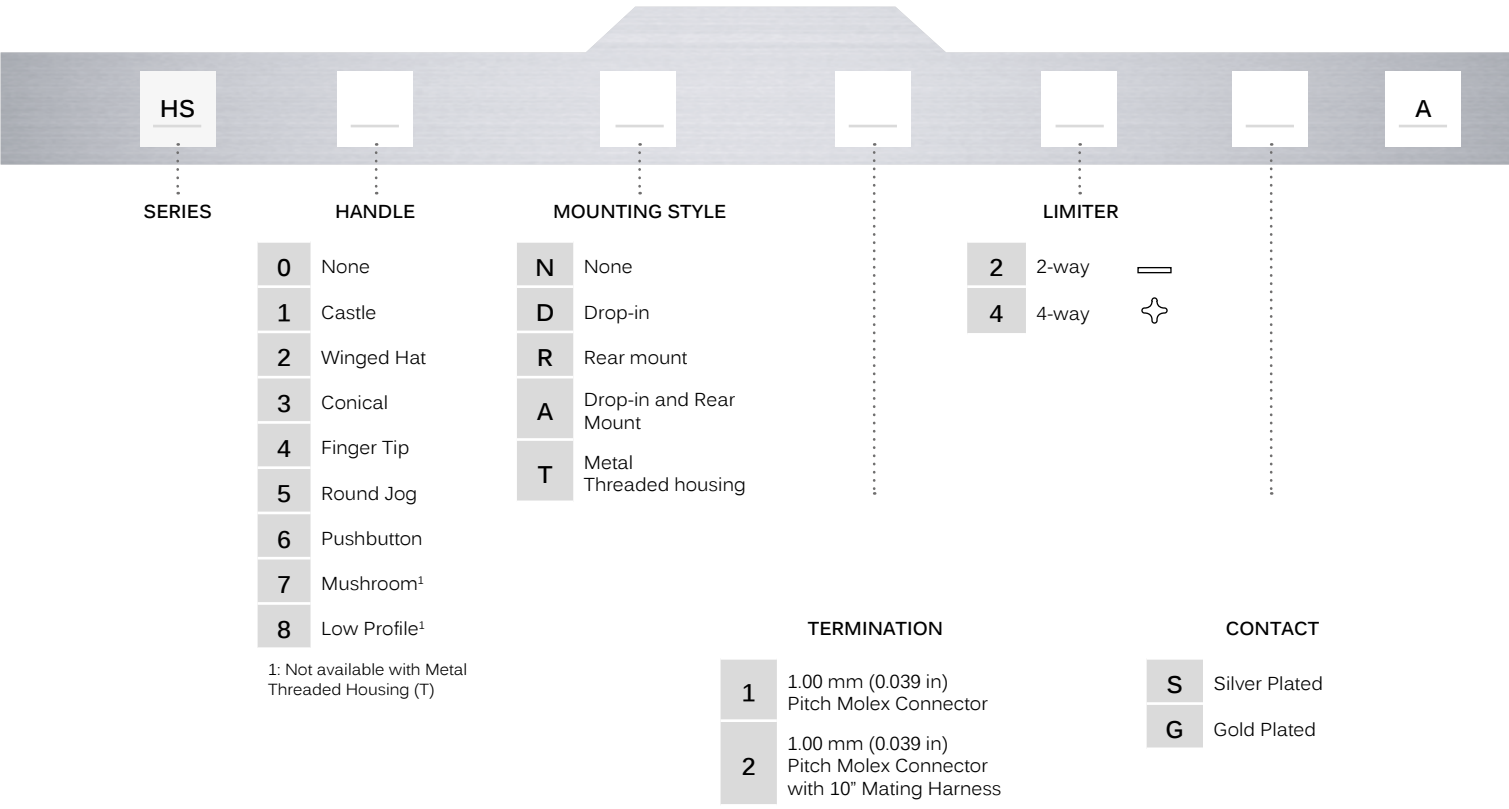

¹: Not available with Metal Threaded Housing (T)

HS series

Micro switch 5-way thumb controls • switching technology

DIMENSIONS

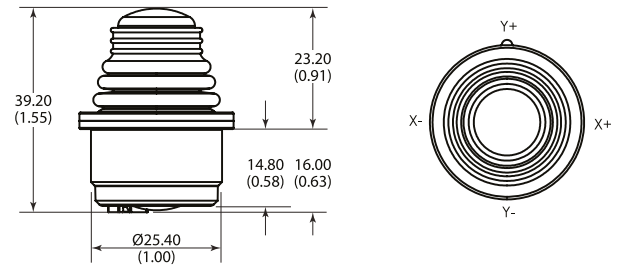

HANDLE OPTIONS

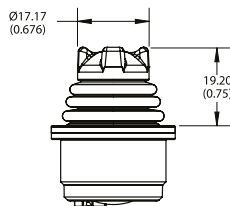

1 Castle

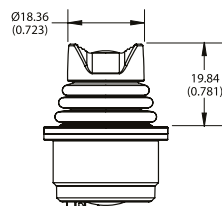

2 Winged hat

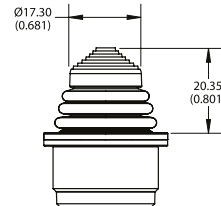

3 Conical

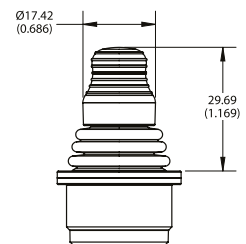

4 Fingertip

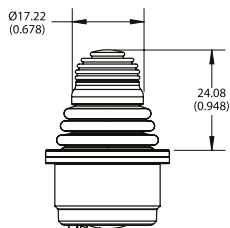

5 Round jog

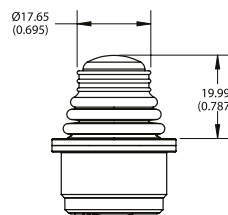

6 Pushbutton

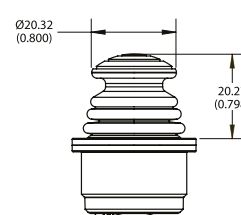

7 Mushroom

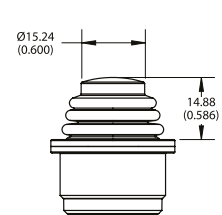

6 Low profile

OPTIONAL MATING HARNESS

- Wire type : 28 AWG 25 cm PTFE
- Connector: Molex 501330-0600
- The HS Series tactile toggle switch is fitted with a six terminal Molex (501331-0607) connector.
- A mating harness is not included, but may be specified at the time of order for an additional charge.
- The 4-function harness is part number 505-508.
- The 5-function harness, necessary for the Option 6 Handle is part number 505-509.