

Ø16mm X6 Series Emergency Stop Switches



Excellent safety and design.
The shortest depth behind the panel in its class.



Actual
Size

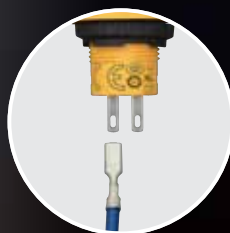

Tab terminal can be
wired easily using quick
connects.

Smooth

Third-generation
Reverse Energy
Structure

First *1

Excellent safety

Unparalleled design

The smooth button is ideal for applications that require utmost cleanliness, such as food processing machines or semiconductor manufacturing equipment. Also suitable for applications requiring a sleek design of emergency stop switches, such as medical equipment.



ø30 mm Button Unmarked ø30 mm Button Arrow Marked ø40 mm Button Unmarked ø40 mm Button Arrow Marked

Smallest
in its
class *1

Only 19.5 mm
depth behind
the panel *2

The short depth behind the panel reduces the required mounting space.
Depth: 30% reduction
Volume: 70% reduction
(Compared with conventional emergency stop switches)
Thus equipment and control panels can be made much smaller.

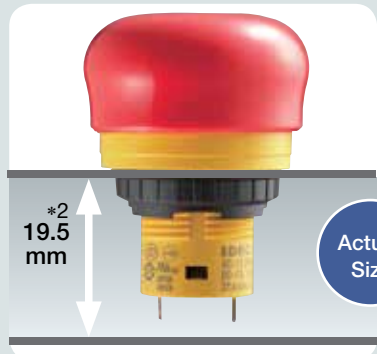

*2: Solder terminal.
Solder/tab terminal: 23.9mm

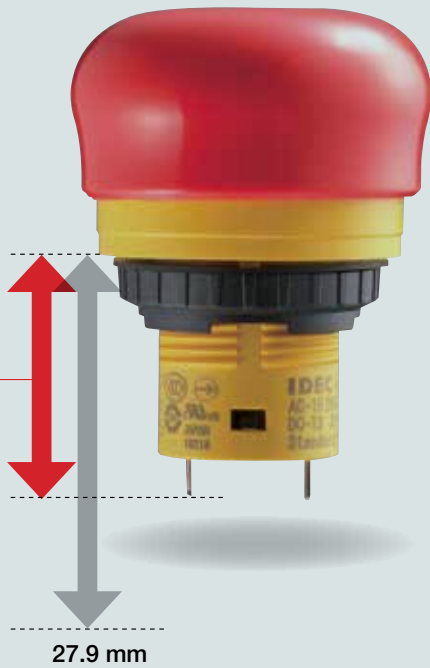

27.9 mm
Conventional emergency stop switch with short depth behind the panel

Clean

Prevents dust build-up

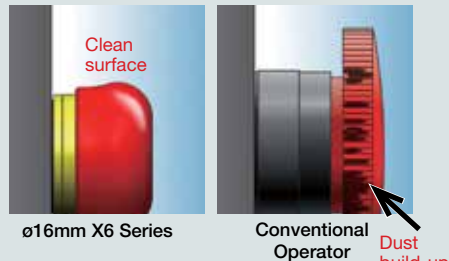

ø16mm X6 Series Conventional Operator Dust build-up

The smooth and ridge-less button surface prevents dust built-up, and is also easy to clean.

Variety

Two ways to reset,
two button sizes,
two wiring methods.

The X6 emergency stop switch can be reset either by pulling or turning. The button is available in ø30 mm and ø40 mm sizes. In addition to a red button, a yellow button is also available as a stop switch. Solder terminals and solder/tab terminals are available.

Two ways to reset



Pull to reset



Turn to reset

Two connection methods



Solder Terminal



Solder/Tab Terminal #110

Third-generation
Reverse Energy
Structure

Highest Safety

IDEC's Unique Reverse Energy Structure

Third Generation

Compliant with international safety standards. Even more consideration has been taken into account on operator safety.

Satisfies the requirements of:

- ① ② ③

+

IDEC's Unique Reverse Energy Structure

Second Generation

Compliant with international safety standards.

Satisfies the requirements of:

- ① ② ③

First Generation

Developed before the establishment of international safety standards.

Satisfies the requirements of:

- ① ②

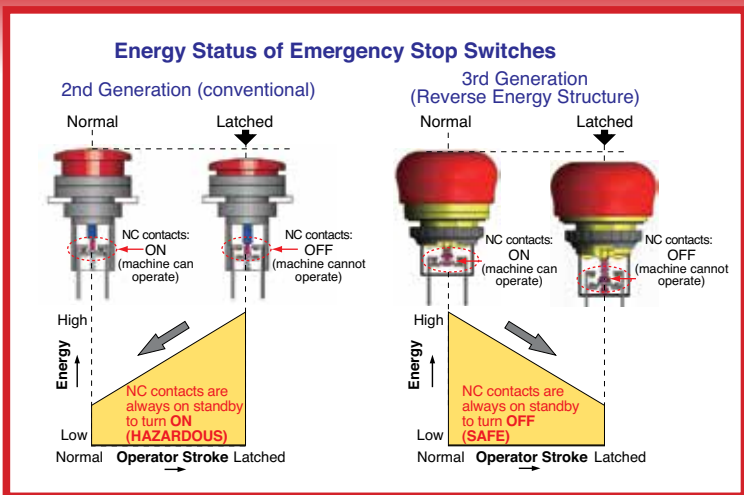

With X series emergency stop switches, the potential energy level of the latched status is lower than that of normal status. In the event the switch is damaged due to excessive shocks, the NC contacts will turn off, thus stopping the machine (patented design).

International Safety Standards Requirements

- ① Red-colored, mushroom actuator, with yellow background. (IEC 60947-5-5; 4.2, ISO 13850; 4.4, IEC 60204-1; 10.7)
- ② Normally closed contacts with a direct opening action (IEC 60947-5-5; 5.2, IEC 60947-5-1; Annex K)
- ③ The emergency stop function shall be maintained by latching of the operator until reset manually (IEC 60947-5-5; 6.2, ISO 13850; 4.4)

High functionality with sleek design

X6 series emergency stop switches for various applications



ø16 X6 Series Emergency Stop Switches (Unibody)

Third-generation emergency stop switch with Reverse Energy Structure Smallest in its class

- Two button sizes—ø30mm and ø40mm
- Two button colors—red for emergency stop and yellow for stop switch
- Two ways of resetting —pulling and turning.
- Solder/tab terminal #110 makes for easy connections.
- UL, c-UL recognized, EN compliant.
- Safety lock mechanism (IEC 60947-5-5; 6.2)
- Direct opening action (IEC 60947-5-5; 5.2, IEC 60947-5-1, Annex K)
- IP65 degree of protection (IEC 60529)



Standards

Standard	Mark	Approval Organization/ File No.
UL508 CSA C22.2 No.14		UL/c-UL File No.E68961
EN60947-5-1 EN60947-5-5 (Note)		TÜV SÜD
		European Commission's Low Voltage Directive
GB14048.5		CCC No. 2012010305525957 (Stop switch: CCC No. 2012010305525958)

- Stop switch (yellow button) is EN60947-5-1

Contact Ratings

Rated Insulation Voltage (Ui)		250V				
Rated Thermal Current (Ith)		5A				
Rated Operating Voltage (Ue)		30V	125V	250V		
Rated Operating Current (Note)	Main Contacts	AC 50/60 Hz	Resistive Load (AC-12)	–	5A	3A
			Inductive Load (AC-15)	–	1.5A	0.75A
	DC	Resistive Load (DC-12)	2A	0.4A	0.2A	
		Inductive Load (DC-13)	1A	0.22A	0.1A	

- Minimum applicable load: 5V AC/DC, 1 mA (reference value) (May vary depending on the operating conditions and load)
- Operational current represents the classification by making and breaking currents (IEC 60947-5-1).

Note:
TÜV/CCC rating: AC-15 0.75A/250V, DC-13 1A/30V
UL rating: Standard Duty AC 0.75A/250V
Standard Duty DC 1A/30V

Specifications





Applicable Standards	IEC 60947-5-1, EN 60947-5-1 IEC 60947-5-5 (Note), EN 60947-5-5 (Note) JIS C8201-5-1, JIS C8201-5-5, UL508 CSA C22.2 No.14, GB14048.5
Operating Temperature	–25 to +60°C (no freezing)
Operating Humidity	45 to 85% RH (no condensation)
Storage Temperature	–45 to +80°C (no freezing)
Operating Force	Push to lock: 10.5N Pull to reset: 8.8N Turn to reset: 0.17 N·m
Minimum Force Required for Direct Opening Action	40N
Minimum Operator Stroke Required for Direct Opening Action	4.5 mm
Maximum Operator Stroke	4.5 mm
Contact Resistance	50 mΩ maximum (initial value)
Insulation Resistance	100 MΩ minimum (500V DC megger)
Overvoltage Category	II
Impulse Withstand Voltage	2.5 kV
Pollution Degree	3
Operation Frequency	900 operations/hour
Shock Resistance	Operation extremes: 150 m/s ² Damage limits: 1000 m/s ²
Vibration Resistance	Operation extremes: 10 to 500 Hz amplitude 0.35 mm, acceleration 50 m/s ² Damage limits: 10 to 500 Hz, amplitude 0.35 mm, acceleration 50 m/s ²
Mechanical Life	100,000 operations minimum
Electrical Life	100,000 operations minimum
Degree of Protection	IP65 (IEC 60529)
Short-circuit Protection	250V/10A fuse (Type aM IEC 60269-1/IEC 60269-2)
Conditional Short-circuit Current	1000A
Terminal Style	Solder terminal, Solder/tab terminal #110
Recommended Tightening Torque for Locking Ring	0.88 N·m
Applicable Wire Size	1.25 mm ² maximum (AWG16 maximum)
Terminal Soldering Condition	310 to 350°C, within 3 seconds
Weight (approx.)	ø30mm button: 13g ø40mm button: 16g

Note: Except for stop switch (yellow button)

Unmarked

Pushlock Pull/Turn Reset Switch

Package quantity: 1





Shape	Main Contact (NC)	Part No.	
		Solder Terminal	Solder/tab Terminal #110
 	1NC	AB6E-3BV01PRH	AB6E-3BV01PTRH
	2NC	AB6E-3BV02PRH	AB6E-3BV02PTRH
 	1NC	AB6E-4BV01PRH	AB6E-4BV01PTRH
	2NC	AB6E-4BV02PRH	AB6E-4BV02PTRH

• Pushlock pull/turn reset switches are locked when pressed, and reset when pulled or turned clockwise.

Arrow Marked

Pushlock Pull/Turn Reset Switch

Package quantity: 1



Shape	Main Contact (NC)	Part No.	
		Solder Terminal	Solder/tab Terminal #110
 	1NC	AB6E-3BV01PRM	AB6E-3BV01PTRM
	2NC	AB6E-3BV02PRM	AB6E-3BV02PTRM
 	1NC	AB6E-4BV01PRM	AB6E-4BV01PTRM
	2NC	AB6E-4BV02PRM	AB6E-4BV02PTRM

• Pushlock pull/turn reset switches are locked when pressed, and reset when pulled or turned clockwise.

Stop Switch

Unmarked, Yellow Button, Pushlock Pull/Turn Reset Switch

Package quantity: 1

Shape	Operator	Main Contact (NC)	Part No.	
			Solder Terminal	Solder/tab Terminal #110
 	ø30mm button	1NC	AB6E-3BV01PY	AB6E-3BV01PTY
		2NC	AB6E-3BV02PY	AB6E-3BV02PTY
	ø40mm button	1NC	AB6E-4BV01PY	AB6E-4BV01PTY
		2NC	AB6E-4BV02PY	AB6E-4BV02PTY

• Pushlock pull/turn reset switches are locked when pressed, and reset when pulled or turned clockwise.
 • Do not use the stop switch as an emergency stop switch.

ø16 X6 Series Emergency Stop Switches (Unibody)

Dimensions

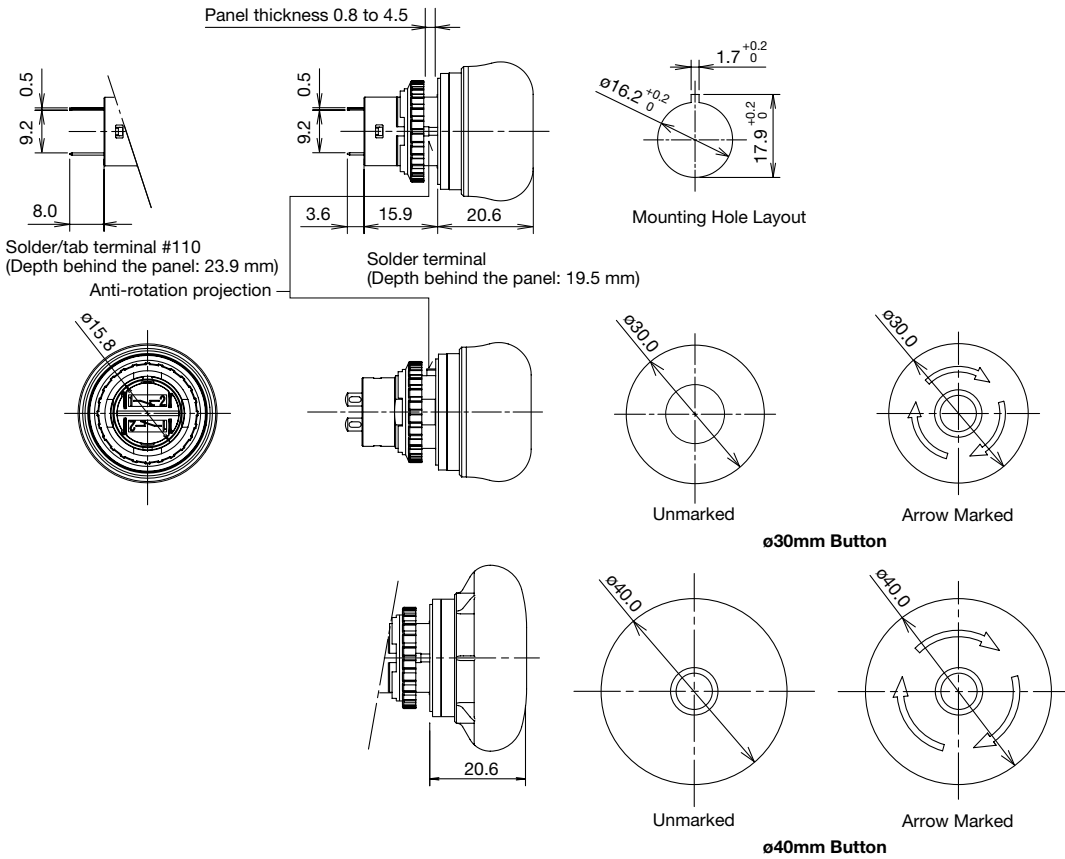

Mounting Hole Layout

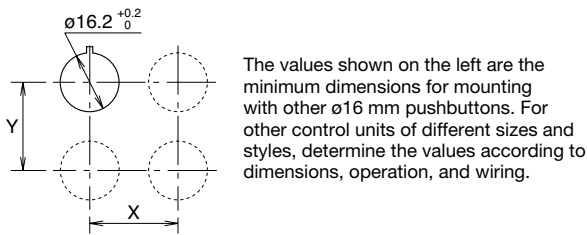

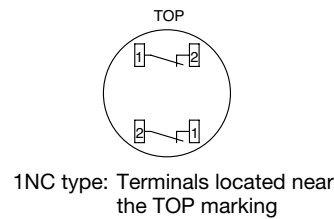

	X	Y
ø30 mm Button	40 mm min.	40mm min.
ø40 mm Button	50 mm min.	50mm min.

Terminal Arrangement (Bottom View)



Accessories

Shape	Material	Part No.	Package Quantity	Remarks
	Metal (nickel-plated brass)	MT-001	1	<ul style="list-style-type: none"> Used to tighten the locking ring when installing the X6 switch onto a panel. Recommended tightening torque: 0.88 N·m maximum
	Plastic	XA9Z-LNPN10	10	<ul style="list-style-type: none"> Black

X6 Series Emergency Stop Switches (Unibody) ø16

Nameplate (for emergency stop switch)

Package quantity: 1

Description	Legend	Part No.	Material	Background Color	Legend Color
For ø30mm Button	Blank	HAAV-0	Polyamide	Yellow	Black
	EMERGENCY STOP	HAAV-27			
For ø40mm Button	Blank	HAAV4-0			
	EMERGENCY STOP	HAAV4-27			

- Cannot be used with switch guard.

SEMI S2 Compliant Switch Guard

Package quantity: 1

Shape	Material	Part No.	Remarks
	Polyamide (PA6)	XA9Z-KG1	<ul style="list-style-type: none"> • IP65 degree of protection • Color: yellow (Munsell 2.5Y8/10 or equivalent) • Cannot be used with nameplate.

Note:

Switch guards have been designed for applications in semiconductor manufacturing equipment only. Do not use the switch guards with emergency stop switches which are installed on other machines such as machine tools or food processing machines. Machinery Directive of the European Commission and IEC 60204-1 require that emergency stop switches be installed in a readily accessible area, and the usage of switch guards is not permitted.

White Nameplate (for stop switch)

Package quantity: 1

Description	Legend	Part No.	Material	Background Color
For ø30mm Button	Blank	HAAV-0-W	Polyamide	White (Munsell N9.5)
For ø40mm Button		HAAV4-0-W		

Dimensions

Nameplate for ø30mm Button
HAAV-*

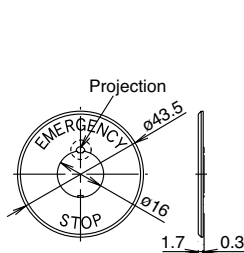

Nameplate for ø40mm Button
HAAV4-*

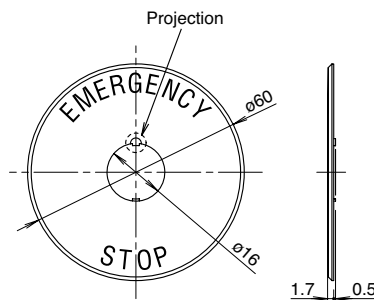

Switch Guard
XA9Z-KG1

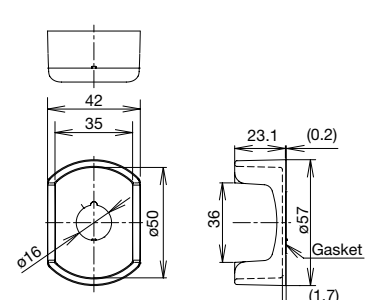

- Remove the projection from the nameplate using pliers, otherwise the switch cannot be installed.
- Panel thickness when using a nameplate: 0.5 to 3 mm

- Panel thickness when using a nameplate: 0.5 to 3 mm

ø16 X6 Series Emergency Stop Switches (Unibody)

Safety Precautions

- Turn off power to the X6 series units before installation, removal, wiring, maintenance, and inspection. Failure to turn power off may cause electrical shocks or fire hazard.
- For wiring, use wires of proper size to meet the voltage and current requirements and solder properly. Improper soldering may cause overheating and create fire hazards.

Instructions

Panel Mounting

Remove the locking ring from the operator and check that the rubber gasket is in place. Insert the operator from panel front into the panel hole. Face the side with the projection upward, and tighten the locking ring using the locking ring wrench MT-001.

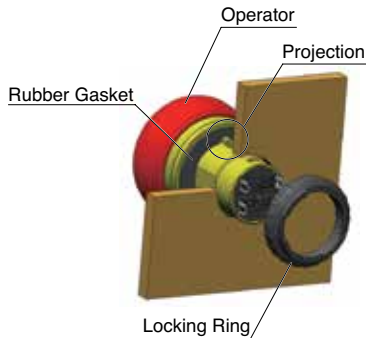

Notes for Panel Mounting

Using the locking ring wrench MT-001, tighten the locking ring to a torque of 0.88 N·m. Do not use pliers. Do not apply excessive force, otherwise the locking ring will become damaged.

Wiring

1. Applicable wire size is 1.25 mm² (16 AWG) maximum.
2. Solder the terminals using a soldering iron at 310 to 350°C for 3 seconds maximum. Do not use flow or dip soldering. SnAgCu type lead-free solder is recommended. Make sure that the soldering iron touches the terminals only, not plastic parts. Do not apply external force such as bending the terminals or applying tensile force on the wires.
3. Use a non-corrosive rosin flux. To prevent the flux from entering the switch while soldering, face the terminals downward.

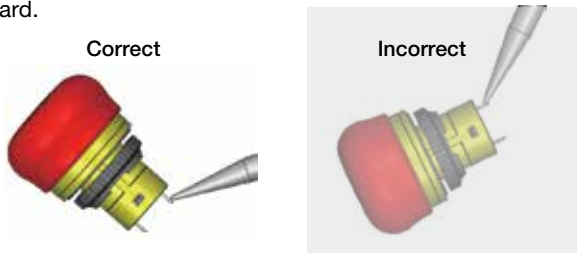

4. Because the terminal spacing is narrow, use protective tubes or heat shrinkable tubes to avoid burning the wire sheath or short circuit.
5. Apply force on the terminals in the vertical direction to the panel only, otherwise the terminals will be damaged.

Notes for Solder/tab terminal #110

1. Use quick connect of #110 and 0.5mm tab thickness.
2. To prevent short-circuit between different poles, use protective tubes or heat shrink tubes.
3. Apply force on the terminals in the vertical direction to the panel only, otherwise the terminals will be damaged.

Contact Bounce

When the button is reset by pulling or turning, the NC contacts will bounce. When designing a control circuit, take the contact bounce time into consideration (reference value: 20 ms). Do not apply any external shock to the emergency stop switches, otherwise the contact will bounce.

Handling

Do not expose the switch to excessive shock and vibrations, otherwise the switch may be deformed or damaged, causing malfunction or operation failure.

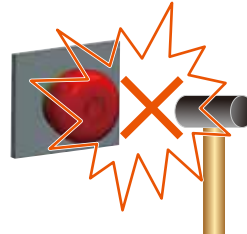

Specifications and other descriptions in this brochure are subject to change without notice.



IDEC CORPORATION

6-64, Nishi-Miyahara 2-Chome, Yodogawa-ku, Osaka 532-0004, Japan
Tel: +81-6-6398-2527, Fax: +81-6-6398-2547
E-mail: marketing@idec.co.jp

IDEC CORPORATION (USA)
1175 Elko Drive, Sunnyvale, CA 94089-2209, USA
Tel: +1-408-747-0550 / (800) 262-IDECA (4332)
Fax: +1-408-744-9055 / (800) 635-6246
E-mail: opencontact@idec.com

IDEC CANADA LIMITED
3155 Pepper Mill Court, Unit 4
Mississauga, Ontario, L5L 4X7, Canada
Tel: +1-905-890-8561, Toll Free: (888) 317-IDECA (4332)
Fax: +1-905-890-8562
E-mail: sales@ca.idec.com

IDEC AUSTRALIA PTY. LTD.
Unit 17, 104 Ferntree Gully Road,
Oakleigh, Victoria 3166, Australia
Tel: +61-3-8523-5900, Toll Free: 1800-68-4332
Fax: +61-3-8523-5999
E-mail: sales@au.idec.com

IDEC ELEKTROTECHNIK GmbH
Heselstruecken 8, 22453 Hamburg, Germany
Tel: +49-40-25 30 54 - 0, Fax: +49-40-25 30 54 - 24
E-mail: service@eu.idec.com

IDEC (SHANGHAI) CORPORATION
Room 701-702 Chong Hing Finance Center,
No. 288 Nanjing Road West, Shanghai 200003, PRC
Tel: +86-21-6135-1515
Fax: +86-21-6135-6225 / +86-21-6135-6226
E-mail: idec@cn.idec.com

IDEC (BEIJING) CORPORATION
Room 211B, Tower B, The Grand Pacific Building,
8A Guanghua Road, Chaoyang District,
Beijing 100026, PRC
Tel: +86-10-6581-6131, Fax: +86-10-6581-5119

IDEC (SHENZHEN) CORPORATION
Unit AB-3B2, Tian Xiang Building, Tian'an Cyber Park,
Fu Tian District, Shenzhen, Guang Dong 518040, PRC
Tel: +86-755-8356-2977, Fax: +86-755-8356-2944

IDEC IZUMI (H.K.) CO., LTD.
Unit G & H, 26/F., MG Tower, No. 133 Hoi Bun Road,
Kwun Tong, Kowloon, Hong Kong
Tel: +852-2803-8989, Fax: +852-2565-0171
E-mail: info@hk.idec.com

IDEC TAIWAN CORPORATION
8F-1, No. 79, Hsin Tai Wu Road, Sec. 1,
Hsi-Chih District, 22101 New Taipei City, Taiwan
Tel: +886-2-2698-3929, Fax: +886-2-2698-3931
E-mail: service@tw.idec.com

IDEC IZUMI ASIA PTE. LTD.
No. 31, Tannery Lane #05-01,
HB Centre 2, Singapore 347788
Tel: +65-6746-1155, Fax: +65-6844-5995
E-mail: info@sg.idec.com

IDEC ASIA (THAILAND) CO., LTD.
20th Fl., Sorachai Bldg., No.23/78,
Soi Sukhumvit 63, Sukhumvit Rd.,
Klongton-nua, Wattana, Bangkok 10110
Tel: +662-392-9765, Fax: +662-392-9768
E-mail: sales@th.idec.com