



## Ultra Short Anti Vandal Switch Ø 19mm / Ø 22mm / Ø 25mm

### Specifications

**Electrical rating:** 50mA, 24VDC  
**Mechanical life:** 1000,000 Cycles  
**Electrical life:** 50,000 Cycles  
**Contact resistance:** 50mΩ Max  
**Insulation resistance:** 1000mΩ Min  
**Dielectric strength:** 2.000VAC  
**Operating / Storage Temperature:** -25°C to 55°C  
**Travel:** 0.5mm  
**Moisture protection:** IP67  
**Actuation force:** 4N  
**Panel thickness:** 1-3mm  
**Mounting nut torque:** 5-14Nm

### Features & Benefits

- 19, 22 or 25mm diameter panel cutout
- Variety of LED option
- Multiple function options
- Ring illumination available
- IP67 rated

### Order Code

Series	Actuator Options	Terminal Options	Function Options	Material Options	Illumination Style Options	LED-Color Options	Illumination Voltage Options	Graphic Options
<input type="checkbox"/> L19U L22U L25U	<input type="checkbox"/> F- Flat	<input type="checkbox"/> <b>NONE</b> -Solder lug(2.0x0.5)	<input type="checkbox"/> <b>M</b> -Momentary <b>1</b> -1NO	<input type="checkbox"/> <b>S</b> -Stainless steel	<input type="checkbox"/> <b>NONE</b> -Non-illum. <b>R</b> -Ring	<input type="checkbox"/> <b>NONE</b> -Non-illum. <b>W</b> - White <b>R</b> - Red <b>O</b> - Orange <b>G</b> -Green <b>B</b> -Blue <b>Y</b> -Yellow	<input type="checkbox"/> <b>NONE</b> -Non-illum. <b>1</b> -Base voltage** 3.3V 6V 12V 24V	<input type="checkbox"/> <b>NONE</b> -Non-illum. <b>LE</b> -Laser etched

### Notes:

\*Base voltage on LEDs:  
 1.8V @ 20mA for red, yellow and orange LED colors  
 2.8V @ 20mA for blue, green and white LED colors

# Dimensions

# Ultra Short Anti Vandal Switch $\varnothing 19\text{mm}$

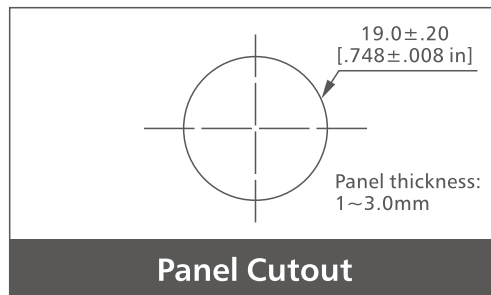
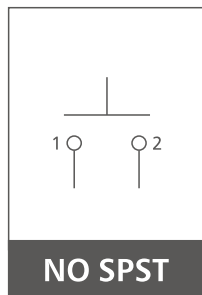
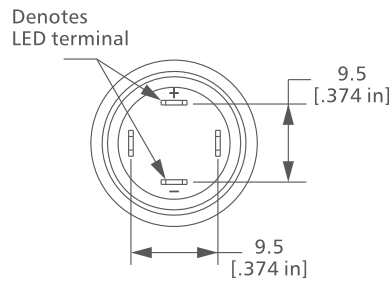
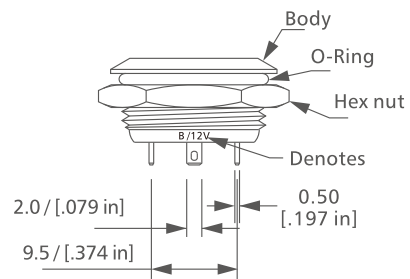
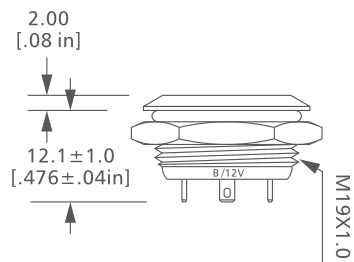
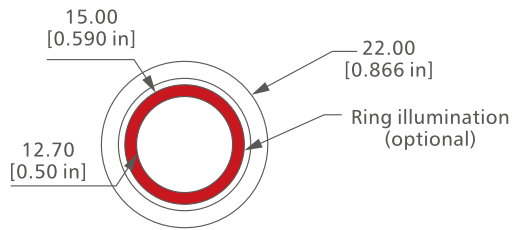

# Dimensions

# Ultra Short Anti Vandal Switch $\varnothing 22\text{mm}$

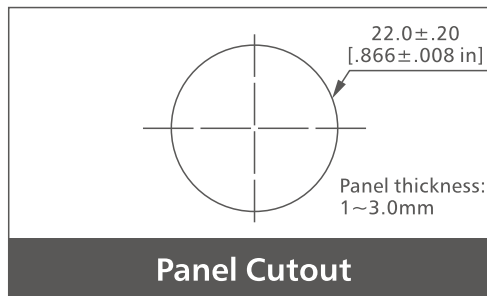
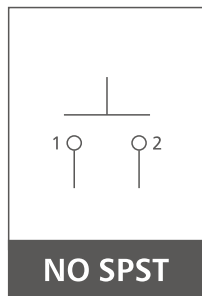
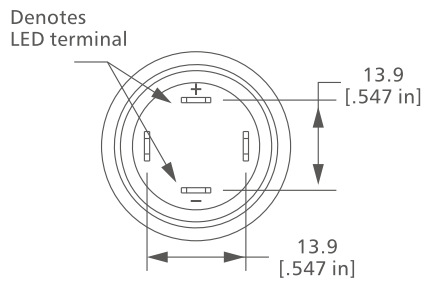
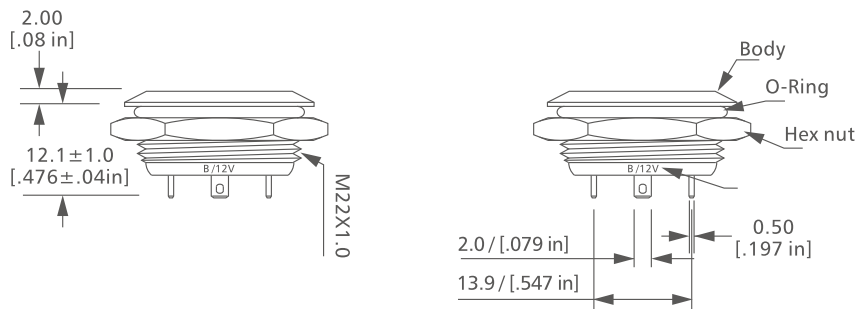
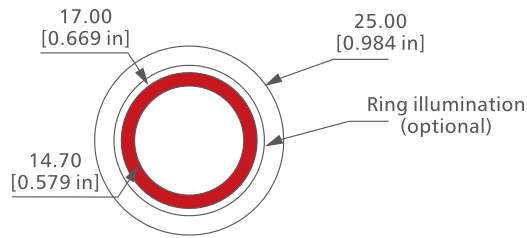

# Dimensions

# Ultra Short Anti Vandal Switch $\varnothing 25\text{mm}$

