



TOYO LED ELECTRONICS LIMITED

Room 1610, Hong Kong Plaza, 188 Connaught Road West, Hong Kong.

Tel : (852) 2540 7288
http://www.toyo-led.com

Fax : (852) 2517 1797
E-mail : sales@toyo-led.com



P/N: TY-Y0805UA1(0.80)

0805 Package 2.0*1.25mm Surface Mount LEDs Series

SPECIFICATION FOR CUSTOMER APPROVAL

P/N: TY-Y0805UA1(0.80)

DATE : August 21, 2015

PREPARED BY : Tang qing

CONFIRMED BY : Yan guoliang

PLEASE CONFIRM & SIGN BACK THIS SHEET TO US

CUSTOMER:

(COMPANY CHOP)

APPROVAL BY:

(SIGNATURE)



TOYO LED ELECTRONICS LIMITED

Room 1610, Hong Kong Plaza, 188 Connaught Road West, Hong Kong.
Tel : (852) 2540 7288 Fax : (852) 2517 1797
http://www.toyo-led.com E-mail : sales@toyo-led.com



P/N: TY-Y0805UA1(0.80)

0805 Package 2.0*1.25mm Surface Mount LEDs Series

✧ Features:

- 2.0*1.25*0.80mm
- Mono-color type
- Soldering methods :All SMT assembly methods
- Comply ROHS standard

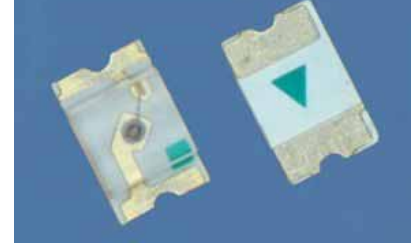

✧ Description

The Red source color devices are made with AlGaInP on sapphire Light Emitting Diode

✧ Application

- Optical indicator
- Indicator and backlighting in telephone and fax
- Flat backlight for LCD, switch and symbol
- Light pipe application
- General use

✧ Package Dimensions

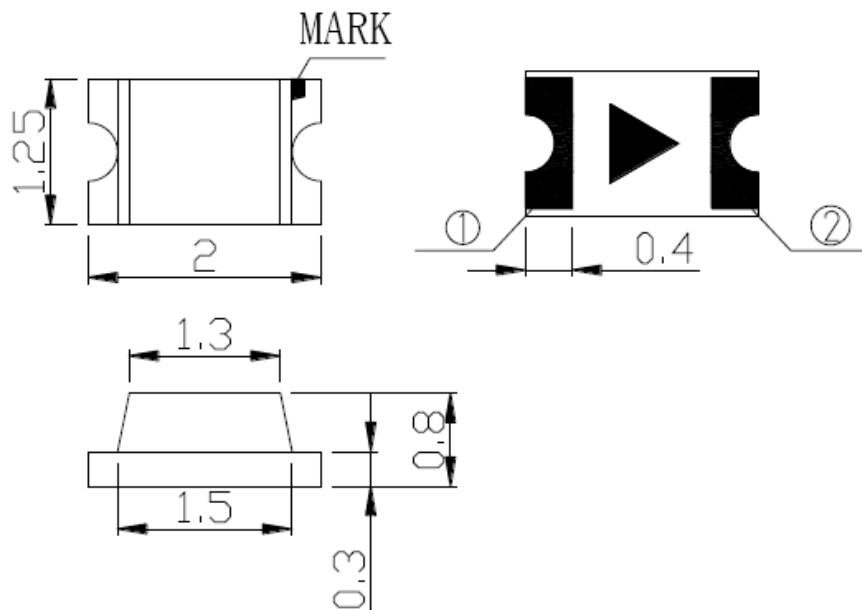

NOTES :

1. All dimensions are in millimeter[unit];
2. Tolerance is ± 0.05 mm unless y other specified;
3. Specifications are subject to change without notice.



TOYO LED ELECTRONICS LIMITED

Room 1610, Hong Kong Plaza, 188 Connaught Road West, Hong Kong.
 Tel : (852) 2540 7288 Fax : (852) 2517 1797
 http://www.toyo-led.com E-mail : sales@toyo-led.com



P/N: TY-Y0805UA1(0.80)

0805 Package 2.0*1.25mm Surface Mount LEDs Series

Part No.	Emitted Color	Len's Color	Chip Material
TY-Y0805UA1(0.80)	Orange	Water Clear	AlGaInP

◇ Absolute Maximum Ratings(Ta=25)

Item	Symbol	Maximum	Unit
Power Dissipation	PD	75	mW
Continuous Forward Current	I _{Fmax}	30	mA
Peak Forward Current(1/10 Duty Cycle 0.1ms Pulse Width)	I _{FP}	80	mA
Reverse Voltage	V _R	5	V
Operating Temperature Range	T _{opr}	-40 to+85	
Storage Temperature Range	T _{stg}	-40 to+85	
Lead Solder Temperature	Tsol	260°C for 3 seconds	

◇ Electrical/Optical Characteristics(Ta=25)

Item	Symbol	Condition	Min.	Typ.	Max	Unit
Forward Voltage	V _F	I _F =20mA	---	1.9	2.3	V
Luminous Intensity	I _V	I _F =20mA	70	150	---	mcd
Wavelength	λ	I _F =20mA	--	600	610	nm
Viewing Angle	2θ _{1/2}	I _F =20mA	--	120	--	Deg
Reverse Current	I _R	V _R =5V	--	--	10	uA



TOYO LED ELECTRONICS LIMITED

Room 1610, Hong Kong Plaza, 188 Connaught Road West, Hong Kong.
 Tel : (852) 2540 7288 Fax : (852) 2517 1797
 http://www.toyo-led.com E-mail : sales@toyo-led.com



P/N: TY-Y0805UA1(0.80)

0805 Package 2.0*1.25mm Surface Mount LEDs Series

◇ Typical Electro-Optical Characteristics Curves

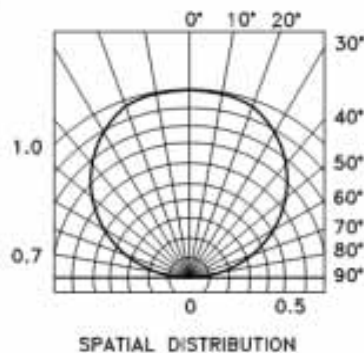
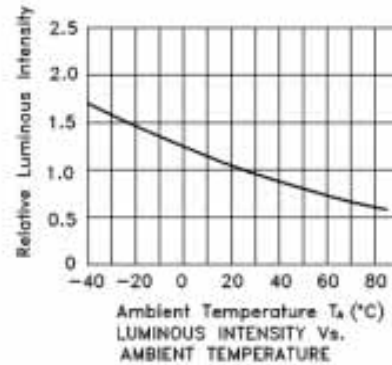
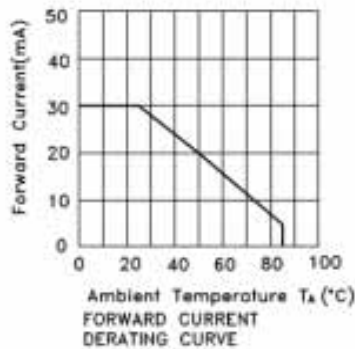
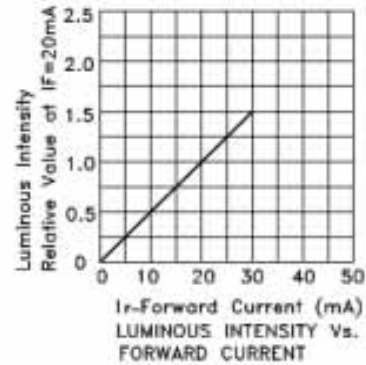
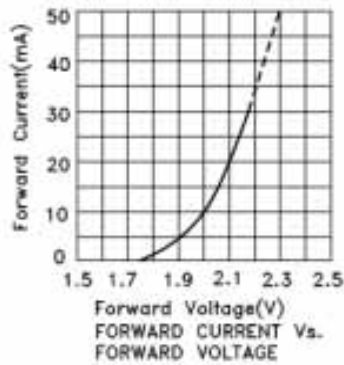
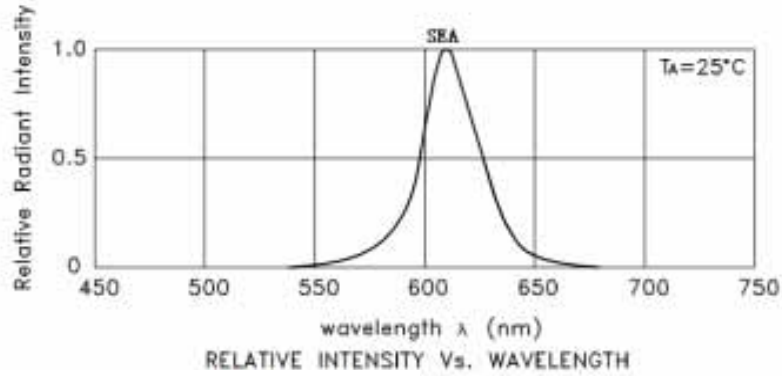



TOYO LED ELECTRONICS LIMITED

Room 1610, Hong Kong Plaza, 188 Connaught Road West, Hong Kong.
 Tel : (852) 2540 7288 Fax : (852) 2517 1797
 http://www.toyo-led.com E-mail : sales@toyo-led.com



P/N: TY-Y0805UA1(0.80)

0805 Package 2.0*1.25mm Surface Mount LEDs Series

◇ Reliability Test Items And Conditions

NO.	Item	Test Condition	Test Hr/cycle/time	Sample Q'ty	Ac/Re
1	Reflow	TEMP:260±5 ; Min.5Sec	6 min	22pcs	0/1
2	Temperature Cycle	H:+100 15mins To(5mins) L:-40 15mins	300 cycles	22pcs	0/1
3	Thermal Shock	H:+100 15mins To(5mins) L:-40 15mins	300 cycles	22pcs	0/1
4	High Temperature Storage	TEMP: 85	1000hrs	22pcs	0/1
5	Low Temperature Storage	TEMP:-40	1000hrs	22pcs	0/1
6	DC Operating Life	IF=20MA	1000hrs	22pcs	0/1
7	High Humidity	85%R.H.	1000hrs	22pcs	0/1

◇ SMT Reflow Soldering Instructions

- 1、 Manual soldering is recommended :
 - a、 keep the temperature of iron below 300 less than 3 seconds
- 2、 Reflow soldering is recommended and the soldering profile is shown below.

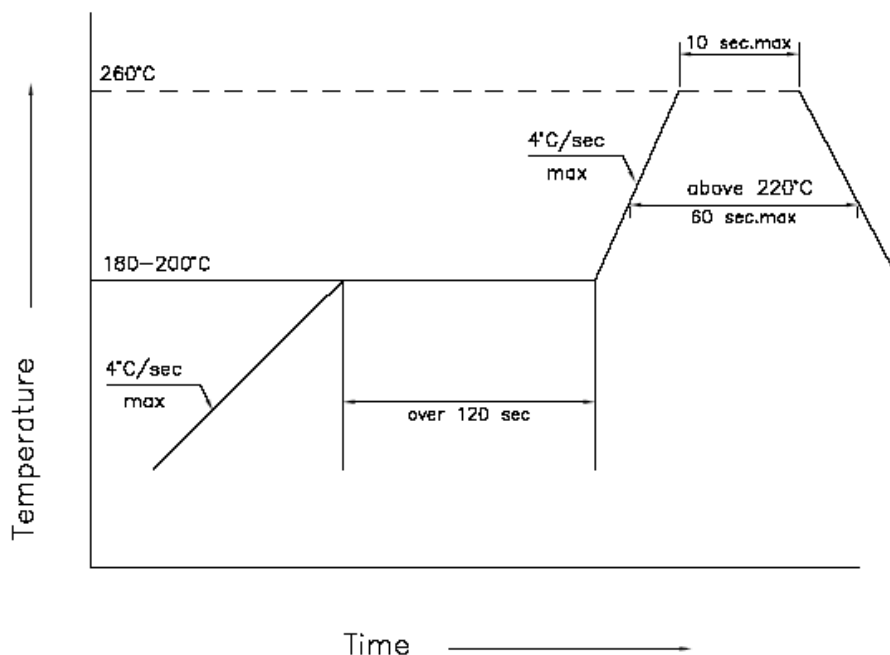



TOYO LED ELECTRONICS LIMITED

Room 1610, Hong Kong Plaza, 188 Connaught Road West, Hong Kong.
Tel : (852) 2540 7288 Fax : (852) 2517 1797
http://www.toyo-led.com E-mail : sales@toyo-led.com



P/N: TY-Y0805UA1(0.80)

0805 Package 2.0*1.25mm Surface Mount LEDs Series

❖ Recommended Soldering Pad Dimensions

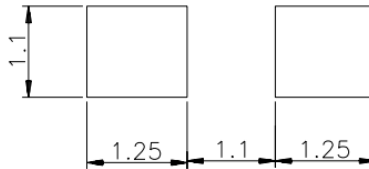

❖ Tape Specification: 3,000PCS per reel

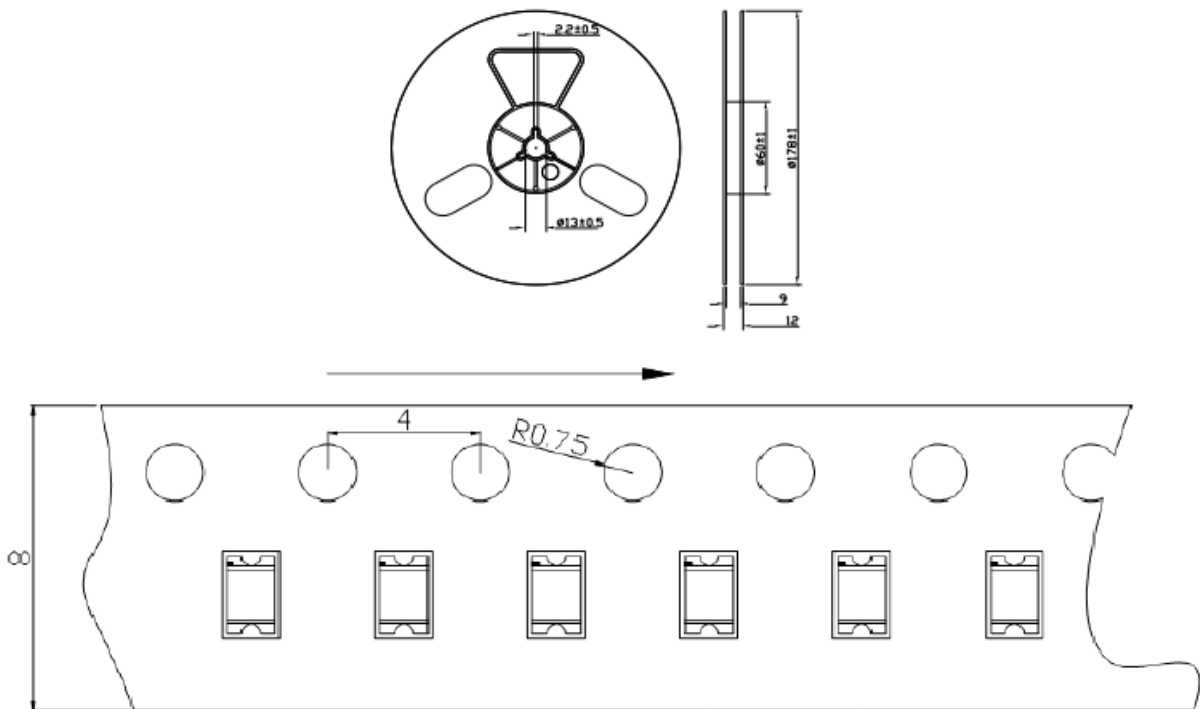

❖ Package Label

SMD LED	
PART NO: _____	QA Pass
LOT NO : _____	
Q' TY : _____	
VF : _____ IV : _____	
WL : _____ BIN: _____	Pb
DATA : _____	
TOYO LED ELECTRONICS LIMITED Website: http://www.toyo-led.com E-mail: sales@toyo-led.com	



TOYO LED ELECTRONICS LIMITED

Room 1610, Hong Kong Plaza, 188 Connaught Road West, Hong Kong.

Tel : (852) 2540 7288
http://www.toyo-led.com

Fax : (852) 2517 1797
E-mail : sales@toyo-led.com



P/N: TY-Y0805UA1(0.80)

0805 Package 2.0*1.25mm Surface Mount LEDs Series

❖ Package & Shipping Instructions

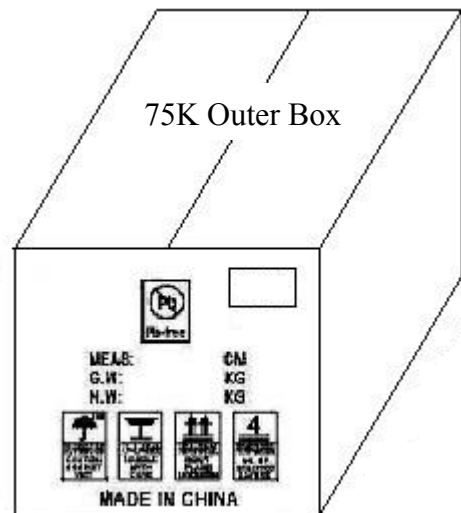
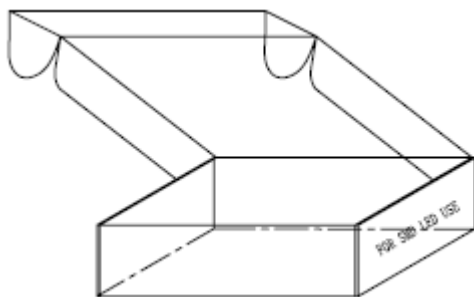
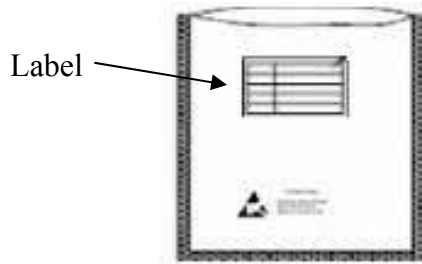
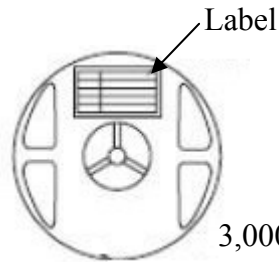

5 Inner boxes/Outer Box (75KPCS)
Size : 350*260*230(mm)