



# TOYO LED ELECTRONICS LIMITED

Room 1610, Hong Kong Plaza, 188 Connaught Road West, Hong Kong.

Tel : (852) 2540 7288  
http://www.toyo-led.com

Fax : (852) 2517 1797  
E-mail : sales@toyo-led.com



**P/N: TY-Y0603PW1(0.60)**

0603 Package 1.6\*0.8mm Surface Mount LEDs Series

# SPECIFICATION FOR CUSTOMER APPROVAL

## P/N: TY-Y0603PW1(0.60)

DATE : March 6, 2014

PREPARED BY : Yanguoliang

CONFIRMED BY :

**PLEASE CONFIRM & SIGN BACK THIS SHEET TO US**

**CUSTOMER:** \_\_\_\_\_

(COMPANY CHOP)

**APPROVAL BY:** \_\_\_\_\_

(SIGNATURE)



# TOYO LED ELECTRONICS LIMITED

Room 1610, Hong Kong Plaza, 188 Connaught Road West, Hong Kong.

Tel : (852) 2540 7288  
http://www.toyo-led.com

Fax : (852) 2517 1797  
E-mail : sales@toyo-led.com



## P/N: TY-Y0603PW1(0.60)

0603 Package 1.6\*0.8mm Surface Mount LEDs Series

### ✧ Features:

- 1.6\*0.8\*0.6 mm
- Mono-color type
- Soldering methods :All SMT assembly methods
- Comply ROHS standard

### ✧ Description

The White source color devices are made with InGaN on sapphire Light Emitting Diode.

### ✧ Application

- LCD backlight
- Illuminations

### ✧ Package Dimensions

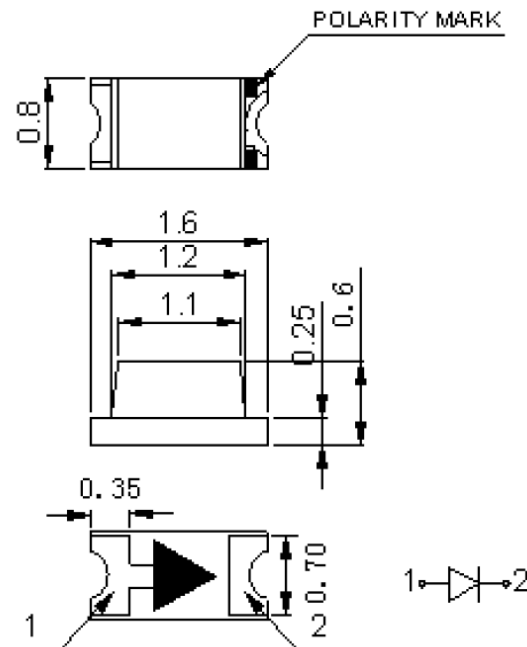

### NOTES:

1. All dimensions are in millimeter;
2. Tolerance is  $\pm 0.1$ mm unless other specified;
3. Specifications are subject to change without notice.



# TOYO LED ELECTRONICS LIMITED

Room 1610, Hong Kong Plaza, 188 Connaught Road West, Hong Kong.

Tel : (852) 2540 7288  
http://www.toyo-led.com

Fax : (852) 2517 1797  
E-mail : sales@toyo-led.com



## P/N: TY-Y0603PW1(0.60)

0603 Package 1.6\*0.8mm Surface Mount LEDs Series

Part No.	Emitted Color	Lens Color	Chip Material
TY-Y0603PW1(0.60)	Pure White	Yellow Diffused	InGaN

### ✧ Absolute Maximum Ratings(Ta=25°C)

Item	Symbol	Maximum	Unit
Power Dissipation	PD	135	mW
Continuous Forward Current	I <sub>Fmax</sub>	30	mA
Peak Forward Current(1/10 Duty Cycle 0.1ms Pulse Width)	I <sub>FP</sub>	140	mA
Reverse Voltage	V <sub>R</sub>	5	V
Operating Temperature Range	T <sub>opr</sub>	-40 to+85	°C
Storage Temperature Range	T <sub>stg</sub>	-40 to+85	°C
Lead Solder Temperature	Tsol	260 °C for 3 seconds	

### ✧ Electrical/Optical Characteristics(Ta=25°C)

Item	Symbol	Condition	Min.	Typ.	Max	Unit
Forward Voltage	V <sub>F</sub>	I <sub>F</sub> =20mA	--	3.2	3.4	V
Luminous Intensity	I <sub>v</sub>	I <sub>F</sub> =20mA	400	--	700	mcd
Color Temperature	T <sub>c</sub>	I <sub>F</sub> =20mA	6000	--	7000	K
Coordinates X,Y		I <sub>F</sub> =20mA	0.23	--	0.35	nm
Viewing Angle	2θ <sub>1/2</sub>	I <sub>F</sub> =20mA	---	120	---	Deg
Reverse Current	I <sub>R</sub>	V <sub>R</sub> =5V	---	---	10	uA



# TOYO LED ELECTRONICS LIMITED

Room 1610, Hong Kong Plaza, 188 Connaught Road West, Hong Kong.

Tel : (852) 2540 7288  
http://www.toyo-led.com

Fax : (852) 2517 1797  
E-mail : sales@toyo-led.com



## P/N: TY-Y0603PW1(0.60)

0603 Package 1.6\*0.8mm Surface Mount LEDs Series

BIN:

### Luminous Intensity(mcd) at 20 mA

Min	Max
400	500
500	600
600	700

### Coordinates X,Y at 20 mA

X1	Y1	X2	Y2	X3	Y3	X4	Y4
0.2613	0.2292	0.2468	0.2361	0.2663	0.2746	0.2779	0.2618
0.2779	0.2618	0.2663	0.2746	0.2874	0.3114	0.2947	0.2942
0.2947	0.2942	0.2874	0.3114	0.3148	0.3498	0.3173	0.3528
0.3173	0.3528	0.3148	0.3498	0.3331	0.3756	0.3352	0.3509

### Forward Voltage at 20 mA

VF1	3.0	3.1
VF2	3.1	3.2
VF3	3.2	3.3
VF4	3.3	3.4



# TOYO LED ELECTRONICS LIMITED

Room 1610, Hong Kong Plaza, 188 Connaught Road West, Hong Kong.

Tel : (852) 2540 7288  
 http://www.toyo-led.com

Fax : (852) 2517 1797  
 E-mail : sales@toyo-led.com



**P/N: TY-Y0603PW1(0.60)**

0603 Package 1.6\*0.8mm Surface Mount LEDs Series

## ✧ Typical Electro-Optical Characteristics Curves

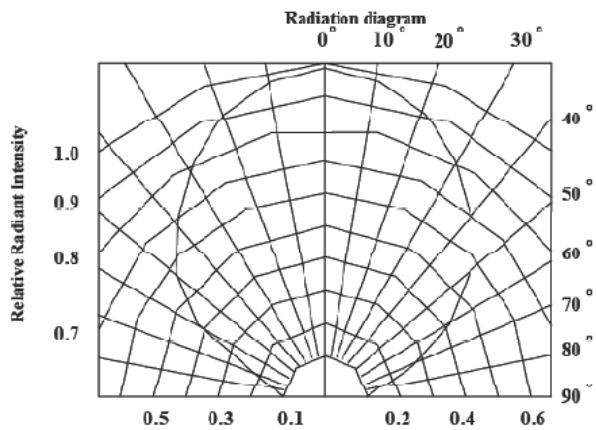
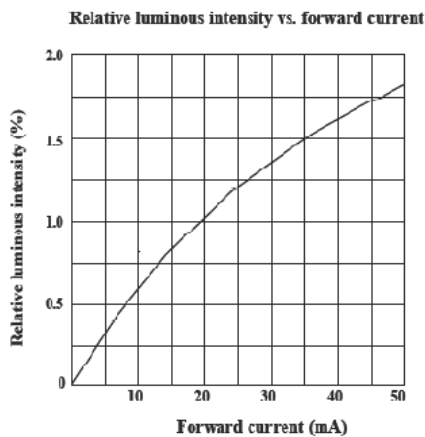
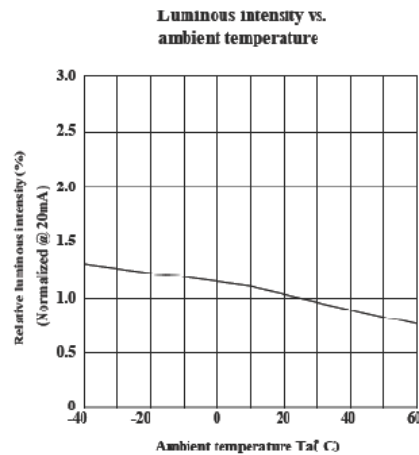
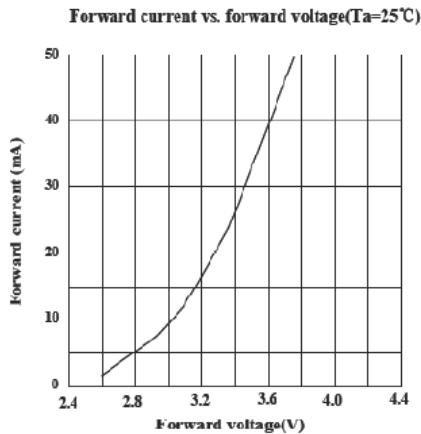
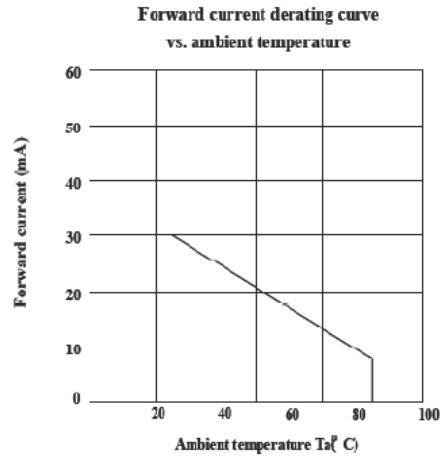
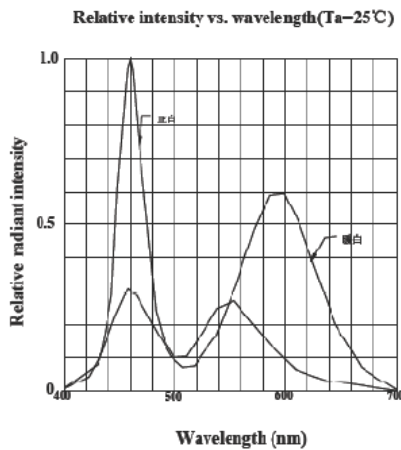



# TOYO LED ELECTRONICS LIMITED

Room 1610, Hong Kong Plaza, 188 Connaught Road West, Hong Kong.  
 Tel : (852) 2540 7288 Fax : (852) 2517 1797  
 http://www.toyo-led.com E-mail : sales@toyo-led.com



**P/N: TY-Y0603PW1(0.60)**

0603 Package 1.6\*0.8mm Surface Mount LEDs Series

## ◇ Reliability Test Items And Conditions

NO.	Item	Test Condition	Test Hr/cycle/time	Sample Q'ty	Ac/Re
1	Reflow	TEMP:260±5°C; Min.5Sec	6 min	22pcs	0/1
2	Temperature Cycle	H:+100°C 15mins To(5mins) L:-40°C 15mins	10 cycles	22pcs	0/1
3	Thermal Shock	H:+100°C 15mins To(5mins) L:-40°C 15mins	10 cycles	22pcs	0/1
4	Low Temperature Storage	TEMP:-40°C	1000hrs	22pcs	0/1
5	DC Operating Life	IF=20MA	1000hrs	22pcs	0/1
6	High Temperature	85°C	1000hrs	22pcs	0/1
7	High Humidity	85%R.H.	1000hrs	22pcs	0/1

## ◇ SMT Reflow Soldering Instructions

Number of reflow process shall be than 2 times and cooling  
 Process to normal temperature is required between first and second  
 soldering process

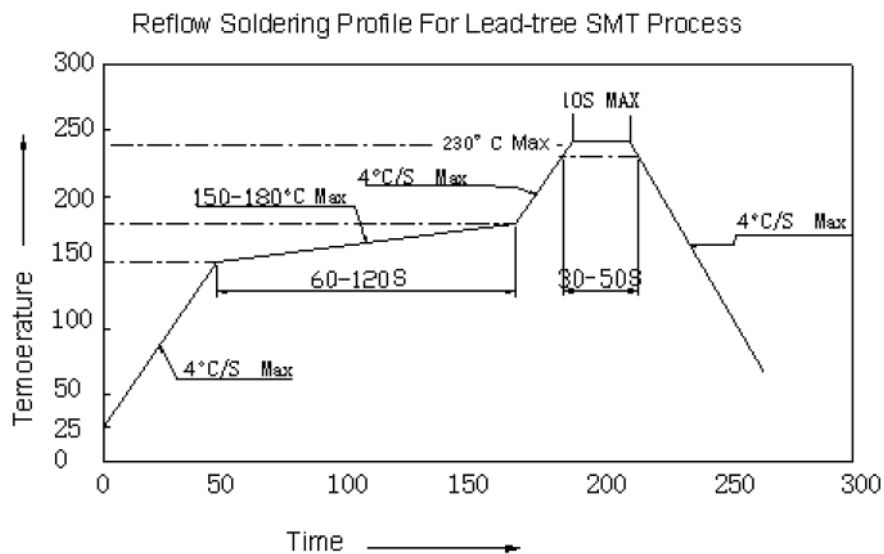



# TOYO LED ELECTRONICS LIMITED

Room 1610, Hong Kong Plaza, 188 Connaught Road West, Hong Kong.  
Tel : (852) 2540 7288 Fax : (852) 2517 1797  
http://www.toyo-led.com E-mail : sales@toyo-led.com



**P/N: TY-Y0603PW1(0.60)**

0603 Package 1.6\*0.8mm Surface Mount LEDs Series

### ◇ Recommended Soldering Pad Dimensions

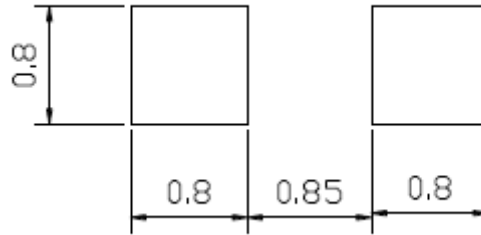

### ◇ Tape Specification: 4,000PCS per reel

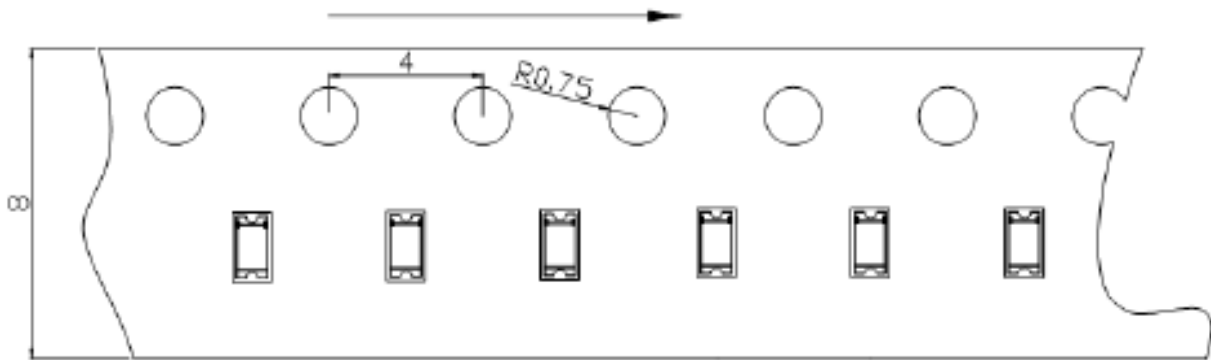

### ◇ Package Label

<b>SMD LED</b>	
PART NO: _____	QA Pass
LOT NO : _____	
Q' TY : _____	
VF : _____ IV : _____	
WL : _____ BIN: _____	<del>Pb</del>
DATA : _____	
TOYO LED ELECTRONICS LIMITED	
Website: <a href="http://www.toyo-led.com">http://www.toyo-led.com</a> E-mail: <a href="mailto:sales@toyo-led.com">sales@toyo-led.com</a>	



# TOYO LED ELECTRONICS LIMITED

Room 1610, Hong Kong Plaza, 188 Connaught Road West, Hong Kong.

Tel : (852) 2540 7288  
http://www.toyo-led.com

Fax : (852) 2517 1797  
E-mail : sales@toyo-led.com



**P/N: TY-Y0603PW1(0.60)**

0603 Package 1.6\*0.8mm Surface Mount LEDs Series

## ❖ Package & Shipping Instructions

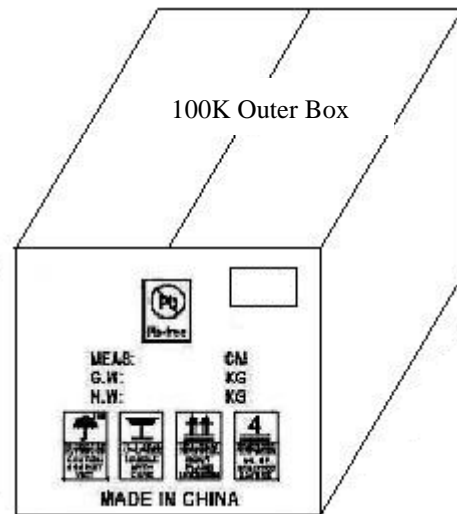
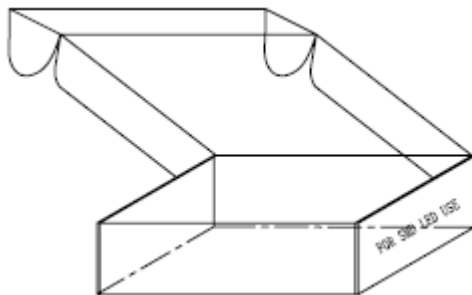
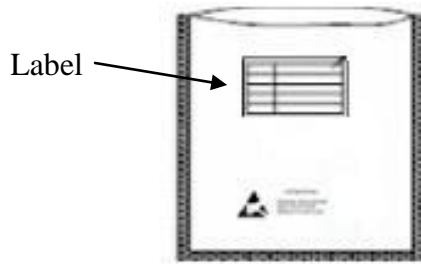
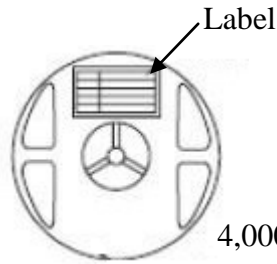

5 Inner boxes/Outer Box (100KPCS)  
Size: 350\*260\*230(mm)