



TOYO LED ELECTRONICS LIMITED

Room 1610, Hong Kong Plaza, 188 Connaught Road West, Hong Kong.
Tel : (852) 2540 7288 Fax : (852) 2517 1797
Http://www.toyo-led.com E-mail : sales@toyo-led.com



P/N: TY-SF7625UYC1

SPECIFICATION FOR CUSTOMER APPROVAL

P/N: TY-SF7625UYC1

DATE : January 7, 2016

PREPARED BY : Chen Li fen

CONFIRMED BY : Yan Guo liang

PLEASE CONFIRM & SIGN BACK THIS SHEET TO US

CUSTOMER: _____ **APPROVAL BY:** _____
(COMPANY CHOP) (SIGNATURE)



TOYO LED ELECTRONICS LIMITED

Room 1610, Hong Kong Plaza, 188 Connaught Road West, Hong Kong.
 Tel : (852) 2540 7288 Fax : (852) 2517 1797
 Http://www.toyo-led.com E-mail : sales@toyo-led.com



P/N: TY-SF7625UYC1

Selection Guide

Part No.	Dice		Lens Color	Iv(mcd)(I _F =20mA)			Viewing Angle (20½)
	Raw Material	Emitted Color		MIN	TYP	MAX	
TY-SF7625UYC1	AlGaInP	Yellow	Water Clear	700	1000		80°

Absolute Maximum Ratings(T_a=25C°)

Item	Symbol	Maximum	Unit
Power Dissipation	P _D	100	mW
Peak Forward Current (1/10 Duty Cycle 0.1ms Pulse Width)	I _{FP}	100	mA
Continuous Forward Current	I _{Fmax}	25	mA
Reverse Voltage	V _R	5	V
Operating Temperature Range	T _{opr}	-20°C to +75°C	
Storage Temperature Range	T _{stg}	-30°C to +80°C	
Lead Solder Temperature	T _{sol}	260°C for 5 seconds (3mm from the base of epoxy)	

Electrical / Optical Characteristics(T_a=25C°)

Item	Symbol	Min.	Typ.	Max.	Unit	Condition
Forward Voltage	V _F	---	2.2	---	V	I _F =20mA
Dominant Wavelength	λ _d	585	590	---	nm	I _F =20mA
Peak Wavelength	λ _p	---	595	---	nm	I _F =20mA
Reverse Current	I _R	---	---	10	uA	V _R =5V

NOTES:

- All dimensions are in millimeter;
- Tolerance is ±0.25mm unless other specified; Luminous intensity tolerance is ±10%;
- Dominant Emission Wavelength tolerance is ±5%; Specifications are subject to change without notice.



P/N: TY-SF7625UYC1

■ Typical Electro-Optical Characteristic Curve:

FIG. 1 Forward Current Vs. Forward Voltage

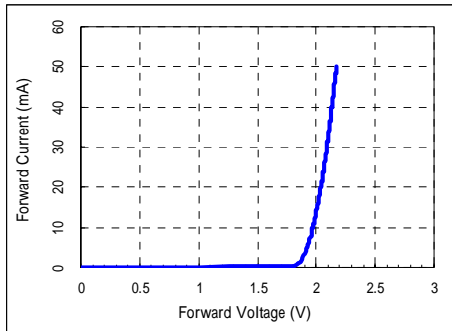

FIG. 2 Relative Intensity Vs. Forward Current

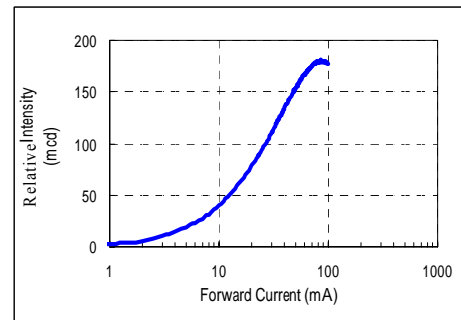

FIG. 3 Forward Voltage Vs. Temperature

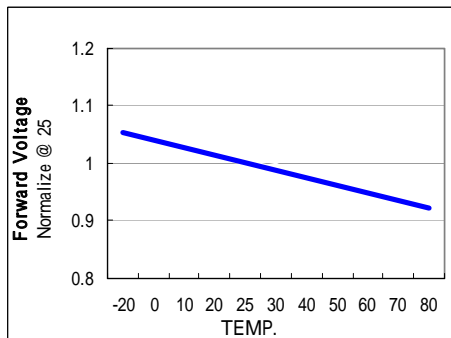

FIG. 4 Relative Intensity Vs. Temperature

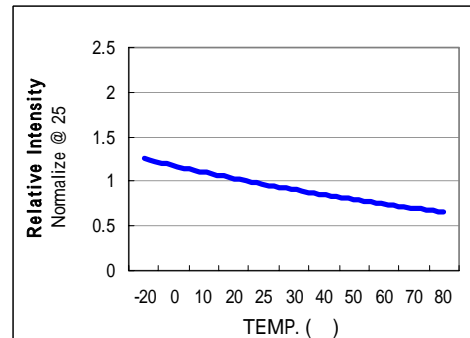
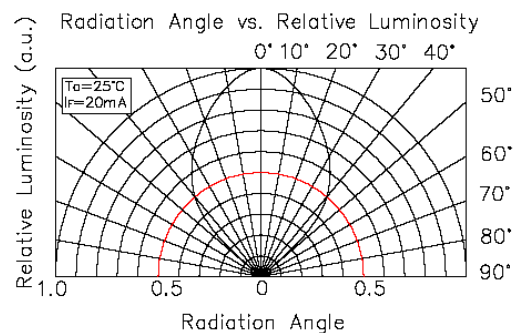
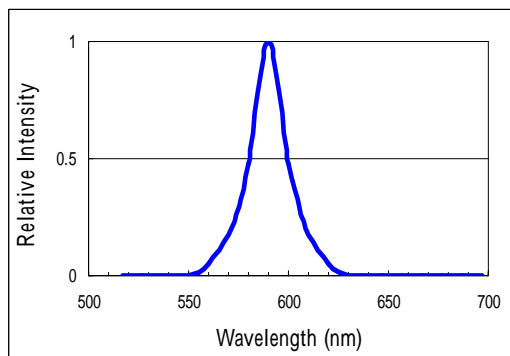

FIG. 5 Relative Intensity Vs. Wavelength





TOYO LED ELECTRONICS LIMITED

Room 1610, Hong Kong Plaza, 188 Connaught Road West, Hong Kong.
Tel : (852) 2540 7288 Fax : (852) 2517 1797
Http://www.toyo-led.com E-mail : sales@toyo-led.com



P/N: TY-SF7625UYC1

BULK & PACKING DIMENSIONS

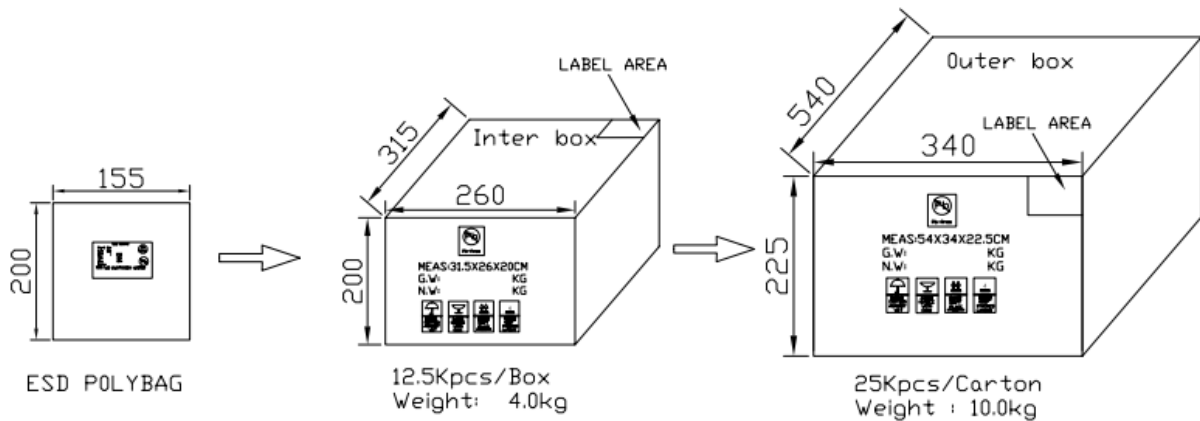
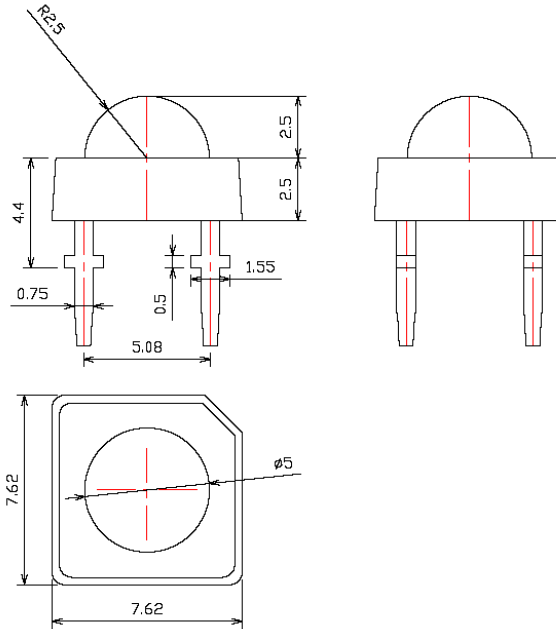

Notes:

1. All dimension are in millimeter (inches);
2. Tolerance is $\pm 0.25\text{mm}$ ($0.01''$) unless otherwise specified.
3. Not recommend to solder within 3mm from the resin.
4. Any kind of LEDs can be made in taped & reel.