

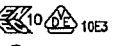

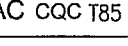

Rating	16A 125VAC 1/3 HP	  	Mounting Hole		Circuit Diagram		
	10A 250VAC 1/2 HP			OFF			
Contact Resistance	50m ohm Max.		Thickness	X	Y	ON	
Insulation Resistance	DC 500V 100M ohm Min.			0.75~1.25	19.2-0.1		
Dielectric Strength	AC 1500V 1 minute		1.25~2	19.4-0.1	13+0.1		
Operation Temperature	-25°C~85°C		2~3	19.8-0.1	13+0.1		
Switch Function	2P SPST ON-OFF						

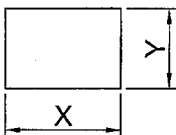
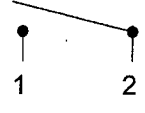
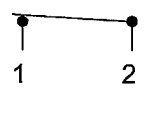
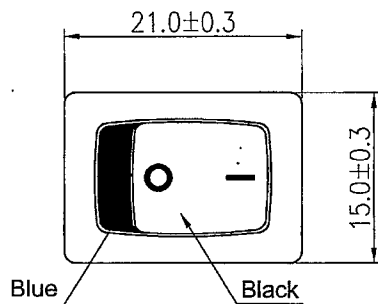
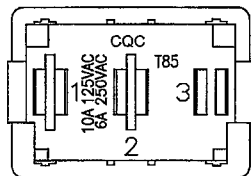
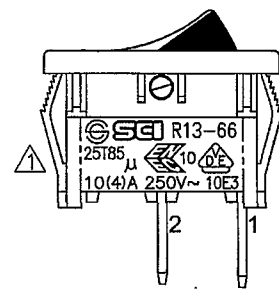
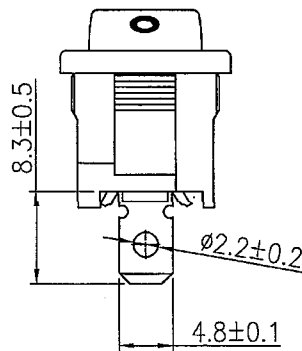
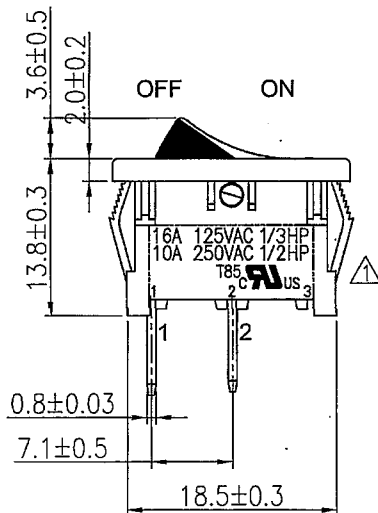

Material:  
 Frame:Black,Nylon 66  
 Actuator:Black /Blue,Nylon 66  
 Terminals: Silver plated, Copper alloy

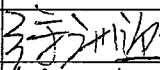
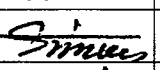

6/14/16	周傑輝	依實物更新安規刻字				
Date	Name	Description				No.
Drawn	Checked	Approved	SCI BOM No.	1824321	Model Name	ROCKER SWITCH
周傑輝			Customer No.		Model No.	R13-66A5-02
6/14/16	6/14/16	6/14/16	Unit	mm	 Shin Chin Industrial Co., Ltd.	Rev. 1