

ISS.	AMEND	DATE
1	ISSUED	19/12/14

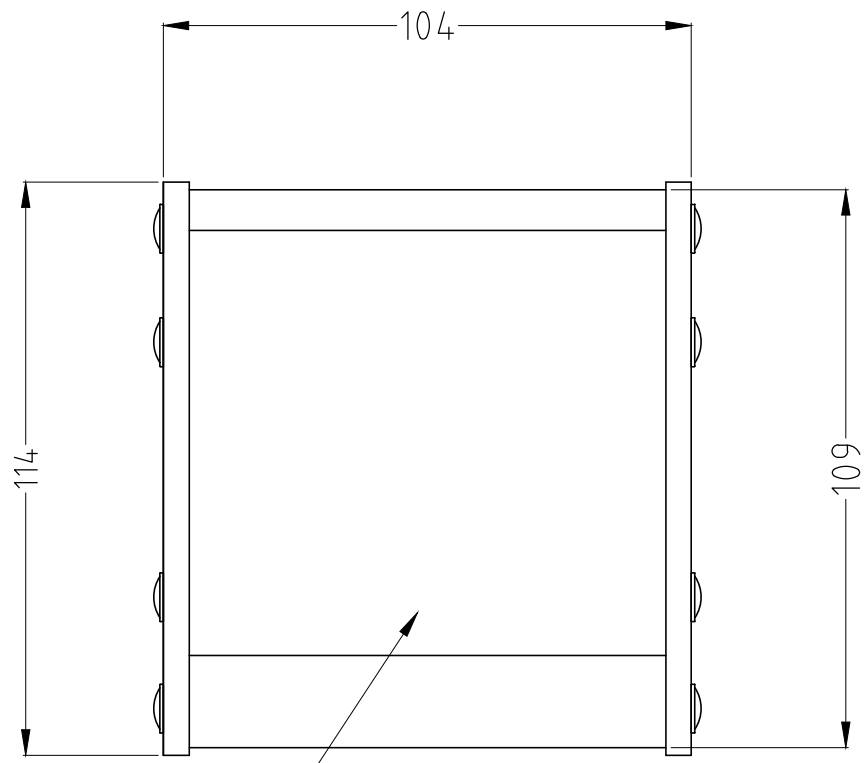

CL2080

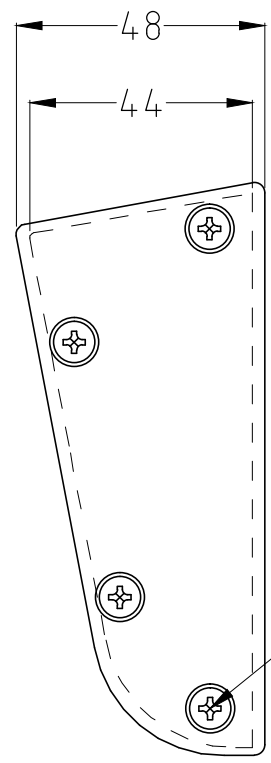

OD65962

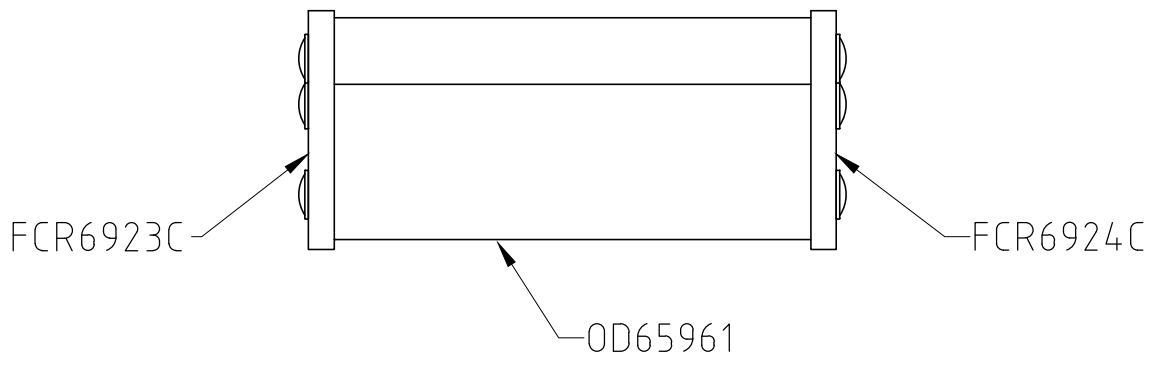
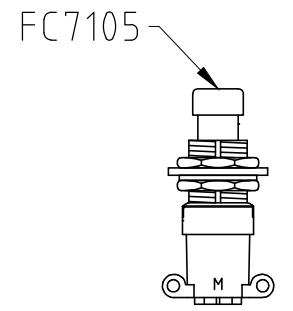

KIT INCLUDES

- 100mm ALI EXTRUSION
- 100mm BASE PLATE
- 1x RH END
- 1x LH END
- 8x SCREWS
- 1x DPDT MOMENTARY SWITCH

SUPPLIED ASSEMBLED + SWITCH

RoHS
COMPLIANT

TOLERANCE

NO DEC. PLACE	±
1 DEC. PLACE	±
2 DEC. PLACE	±
HOLE Ø	±
ANGLES	±
UNLESS OTHERWISE STATED	

Cliff Electronic Components Ltd.
76 Holmethorpe Avenue, Holmethorpe Industrial Estate,
Redhill, Surrey, RH1 2PF, England, UK
Tel: 01737-771375 Fax: 01737-766012 Website: www.cliffuk.co.uk

DIMENSIONS IN MILLIMETERS UNLESS OTHERWISE STATED. WORK TO DIMENSIONS. REMOVE ALL BURRS. IF IN DOUBT ASK.

3rd ANGLE PROJECTION:

DO NOT SCALE

MATERIAL: ALI / POLYAMIDE / PVC / STEEL

TITLE: MOMENTARY FOOT PEDAL (100mm)

FINISH: CLEAN

DRWG. No. **CL2108C** FORM: A4DRWGH

THE CONTENTS OF THIS DOCUMENT MUST NOT BE COPIED OR DISCLOSED TO A 3rd PARTY WITHOUT WRITTEN PERMISSION OF CLIFF UK. © 2013

DRAWN: T.J.O.

APPROVED: D.P.J.

CLIFF

SWITCHES

4066 SERIES



- FC71025** SPDT ON/OFF solder tags.
- FC71035** SPDT ON/OFF PC tags
- FC7105** DPDT Momentary solder tags.
- FC71055** DPDT ON/OFF solder tags.
- FC7106** DPDT Momentary PC tags
- FC71065** DPDT ON/OFF PC tags

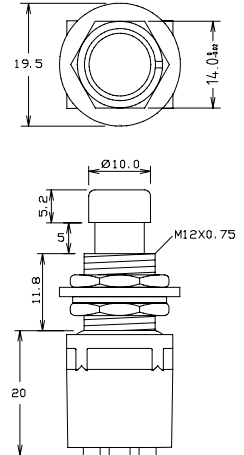

Rated 1A. 250VAC

Contact Sales for full drawing and specification.

3 POLE SERIES



FC71101

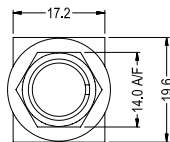

3PDT switch solder tags

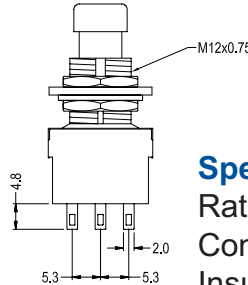
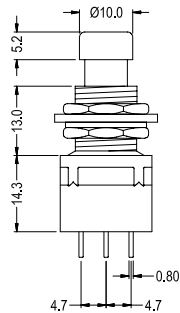

Specification

Rating: AC125V 4A, 250V 2A.
 Contact Resistance: 20mΩ max.
 Insulation Resistance: DC500V 100MΩ min.
 Dielectric Strength: AC1500V 1 minute.
 Operating temp: -20°C to +65°C
 Electrical life: 20,000 make/break cycles at full load.



FC71102

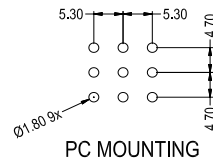
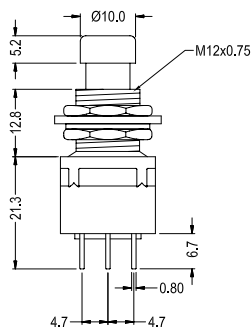
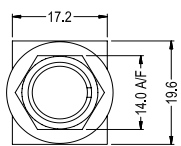

3PDT switch PCB tags.

For further information, contact: sales@cliffuk.co.uk

